

KYOWA SERVICE CENTER (MAIN)

RM. 1203, STATE CENTER BLDG, #333 JUAN LUNA ST, BINONDO MANILA
TEL: 242-1731 - 35

METRO MANILA

TRONIX QUEZON CITY (MAIN) #777 N.S. AMORANTO ST, COR. STO. DOMINGO AVE, Q.C.
TEL: 743-9094 / 749-8477 MOBILE: 0922-8534797/0917-5231489 CONTACT PERSON: MS. JENIELYN MANZANO

TRONIX MANILA #1793 CONCEPCION AGUILA ST, NEAR J.P. LAUREL ST, SAN MIGUEL, MANILA (NEAR MALACANANG)
TEL: 743-4088 MOBILE: 0922-7909555 CONTACT PERSON: MS. ANALEN FIADACAN

TRONIX STA. CRUZ #910 LUZON ST. (BET. MASANGKAY & BENAVIDEZ ST.) STA. CRUZ, MANILA
TEL: 542-8345 / 310-3553 MOBILE: 0922-2389971 CONTACT PERSON: MS. SHEILA PIRANTE

TRONIX SAN JUAN #135 N.DOMINGO ST, CORNER PINAGLABANAN, BRGY. BALONG BATO, SAN JUAN CITY
TEL: 949-3608 / 984-6395 MOBILE: 0922-9218653 CONTACT PERSON: MS. MICHELLE CASAÑA

TRONIX ALABANG TOWN CENTER LA-7 SERVICE TOWN, ALABANG TOWN CENTER, MUNTINLUPA CITY
TEL: 807-3546 / 624-6880 MOBILE: 0922-7584917 / 0917-5899059 CONTACT PERSON: MR. FRANCIS ACOSTA

TRONIX PARAÑAQUE #103 CMSR BLDG, PHASE 1, 88 PRESIDENT AVENUE, BF HOME, PARAÑAQUE
TEL: 622-4540 / 861-0092 / 828-2915 MOBILE: 0917-5978342 / 0932-4060806 CONTACT PERSON: MS. ELIZABETH PALIMA

TRONIX MAKATI #103 MJM BLDG, 650 JP RIZAL ST, BRGY. VALENZUELA MAKATI CITY
TEL: 710-1980 / 949-3684 MOBILE: 0932-1999085

TRONIX MARIKINA #572 J.P. RIZAL AVE, CONCEPCION 1, MARIKINA (IN FRONT OF KSERVICO)
TEL: 696-6411 MOBILE: 0942-0940088

TRONIX PASIG LOWER GROUND SERVICE LANE, SM CENTER, PASIG
TEL: 703-5599 / 234-9020 MOBILE: 0932-1999372 CONTACT PERSON: MS. NORA CRESENCIO

TRONIX SHAW - MANDALUYONG #412 SHAW BLVD, COR. TORRES & CALDERON ST, MANDALUYONG CITY
TEL: 542-8360 / 725-7290 MOBILE: 0923-1646350 CONTACT PERSON: MS. SHERLY DELA CRUZ

TRONIX COMMONWEALTH LAGMANLAG COMMONWEALTH AVE, HOLY SPIRIT, DILIMAN, Q.C. (BESIDE SHELL)
TEL: 623-7266 MOBILE: 0933-6584465 / 09175810546 CONTACT PERSON: MR. MANNY SAGAYAP

CAVITE

TRONIX CAVITE KM 16, AGUINALDO HI-WAY, NIOG 1-A, PANAPPAAN 1, BACOR, CAVITE
TEL: (046) 519-0755 / (046) 475-6362 MOBILE: 0932-1991811 CONTACT PERSON: MS. MEANN DIONISIO

CEBU

MARKWELL ENTERPRISES #85 SIKATUNA ST, CEBU CITY
TEL: (032) 253-0752 MOBILE: 0917-6256934 CONTACT PERSON: MR. BOY SOUICO

BIO PLUS ELEC. REPAIR CENTER C. PADILLA ST, SAN ROQUE, MAMBALING, CEBU CITY
TEL: (032) 262-1339 MOBILE: 0922-4744991 CONTACT PERSON: MS. ZYSELDA MABUTE

DAVAO

KOOL EXPRESS DOOR 5, LUA BLDG, QUIRINO AVE, DAVAO CITY
TEL: (082) 227-6369 MOBILE: 0908-420-6303 CONTACT PERSON: MS. DORIS ASIRIT

ILOILO

NACES APPLIANCE CORPORATION NACES BLDG, #10 DELGADO ST, ILOILO
TEL: (033) 337-7696 MOBILE: (033) 508-2205 CONTACT PERSON: MS. LORELIE LIM

TARLAC

TARLAC MAC ENTERPRISES INC. BLK. 9, MCARTHUR HIGHWAY, SAN NICOLAS, TARLAC
TEL: (045) 982-3178 MOBILE: 0922-8597136



GAS STOVE

MODEL NO.: KW-3566



INSTRUCTION MANUAL

CONGRATULATIONS

You are now a proud new owner of a KYOWA Gas Stove model no. KW-3566.

Before using for the first time, kindly take time to carefully read your instruction manual. Please observe all safety precautions and follow operating procedures. After reading, kindly store your instruction manual in a safe place for your future reference. Should you pass on this Gas Stove to a third party, please hand over this instruction manual as well.

PARTS DESCRIPTION

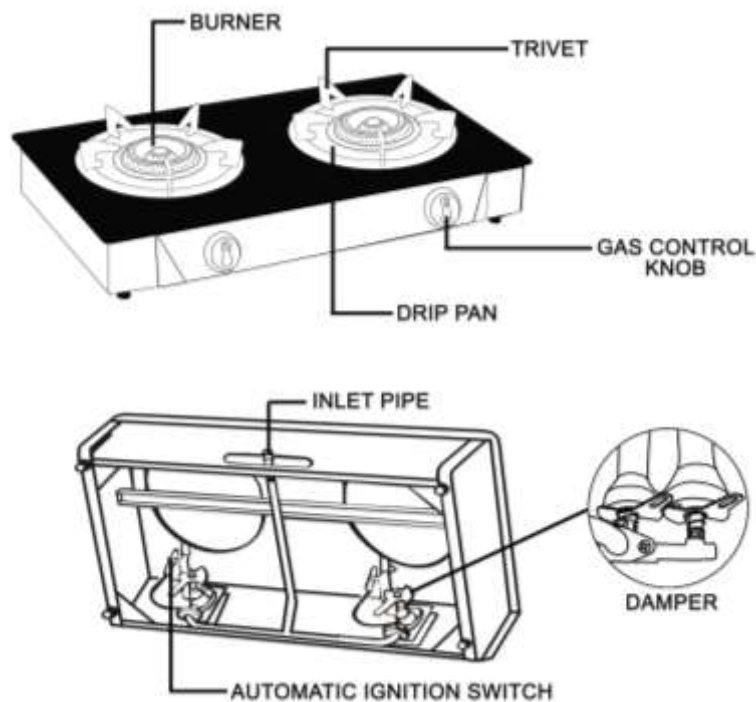

IMPORTANT SAFEGUARDS

When using your Kyowa Gas Stove, basic safety precautions should always be followed:

- Use liquefied petroleum gas (LPG) only from reputable and authorized dealers.
- Always use good quality standard size gas hose.
- Use a regulator with auto safety feature and with pressure gauge.
- Do not place gas hose at the bottom of the stove.
- Do not use or replace accessories of the Gas Stove other than the ones originally provided.
- Do not operate the Gas Stove if any part of it has been damaged. Return the appliance to the nearest authorized dealer or service facility for repair.
- Do not operate or place any part of your Gas Stove on or near any hot surfaces such as an electric burner, hotplate or heated oven.
- Put heavy pots over the burner gently.
- Maximum pot and food weight for each burner is 5 kgs.
- Do not drop any kind of heavy objects on the glass surface or on the burner part of the Gas Stove.
- Avoid any cold liquid to spill over the glass top of the stove while in use.
- Avoid touching hot surfaces of the Gas Stove during use.
- Never leave the Gas Stove unattended when turned ON. Always switch unit to OFF when not in use or before cleaning.
- Always make sure that the burners are free from any blockage. Use steel wire to clean out clogged holes of the burner.
- Do not immerse or expose the Gas Stove to rain, moisture or any liquid.
- Never allow water or any kind of liquid to seep into the automatic ignition switch.
- Keep out of reach from children or from persons with mental or physical disabilities.

HOW TO USE

- Remove all packaging materials from the Gas Stove.
- Push gas hose up to the red marking on the inlet pipe.
- Fasten hose into the inlet pipe by tightening hose clamp.

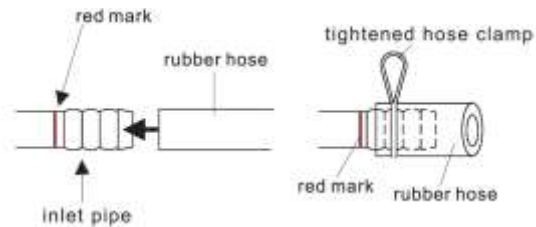

- Open the main gas valve.

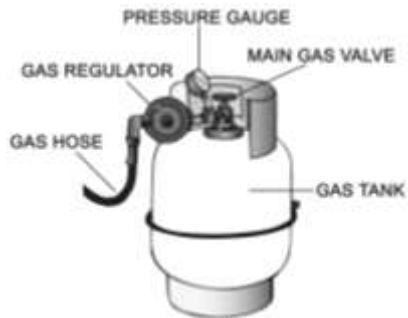

- Make sure to attach trivet (packed at bottom portion) before using the stove.

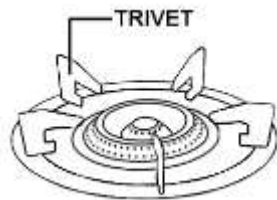

- Push gas control knob then turn counter-clockwise until you hear the ignition click and fire comes out of the burner.
- When fire does not come out of the burner, simply turn back knob to OFF then try to turn it ON again.

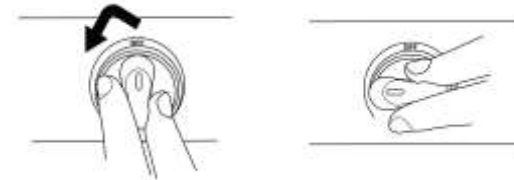

- To turn Gas Stove to OFF, turn gas control knob clockwise.



- Regulate flame quality coming out of the burner by adjusting damper under the body of the stove. Move damper clockwise or counter-clockwise until you have obtained good flame quality as shown below:

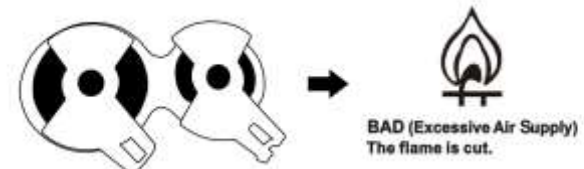
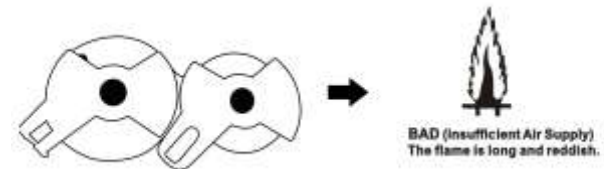
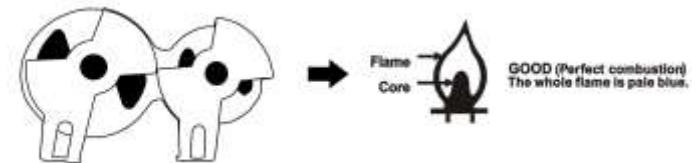

CLEAN AND CARE

- Allow Gas Stove to completely cool down before cleaning.
- Wash movable parts under running water. Never use dishwasher or pour hot water on the unit when cleaning.
- Do not use harsh cleaning agents or abrasive objects (e.g. scrubbing pads or metal brushes) for cleaning.
- Use damp cloth to clean body of the Gas Stove.
- Pat dry all parts using a soft, dry cloth.
- Put back parts and accessories of the Gas Stove to their proper places before operating again.

SERVICE

- Do not operate your KYOWA Gas Stove if the unit malfunctions or appears damaged in any manner. Bring the complete product to the place of purchase or to any authorized KYOWA dealers for inspection, repair or replacement.
- Do not disassemble your KYOWA Gas Stove by yourself. No user serviceable parts inside. Refer all needed repair to an authorized KYOWA service facility ONLY.