

KYOWA SERVICE CENTER (MAIN)

RM. 1203, STATE CENTER BLDG, #333 JUAN LUNA ST, BINONDO MANILA
TEL: 242-1731 - 35

METRO MANILA

TRONIX QUEZON CITY (MAIN) #777 N.S. AMORANTO ST, COR. STO. DOMINGO AVE, Q.C.
TEL: 743-9094 / 749-8477 MOBILE: 0922-8534797/0917-5231489 CONTACT PERSON: MS. JENIELYN MANZANO

TRONIX MANILA #1793 CONCEPCION AGUILA ST, NEAR J.P. LAUREL ST, SAN MIGUEL, MANILA (NEAR MALACANANG)
TEL: 743-4088 MOBILE: 0922-7909555 CONTACT PERSON: MS. ANALEN FIADACAN

TRONIX STA. CRUZ #910 LUZON ST. (BET. MASANGKAY & BENAVIDEZ ST.) STA. CRUZ, MANILA
TEL: 542-8345 / 310-3553 MOBILE: 0922-2389971 CONTACT PERSON: MS. SHEILA PIRANTE

TRONIX SAN JUAN #135 N.DOMINGO ST, CORNER PINAGLABANAN, BRGY. BALONG BATO, SAN JUAN CITY
TEL: 949-3608 / 984-6395 MOBILE: 0922-9218653 CONTACT PERSON: MS. MICHELLE CASAÑA

TRONIX ALABANG TOWN CENTER LA-7 SERVICE TOWN, ALABANG TOWN CENTER, MUNTINLUPA CITY
TEL: 807-3546 / 624-6880 MOBILE: 0922-7584917 / 0917-5899059 CONTACT PERSON: MR. FRANCIS ACOSTA

TRONIX PARAÑAQUE #103 CMSR BLDG, PHASE 1, 88 PRESIDENT AVENUE, BF HOME, PARAÑAQUE
TEL: 622-4540 / 861-0092 / 828-2915 MOBILE: 0917-5978342 / 0932-4060806 CONTACT PERSON: MS. ELIZABETH PALIMA

TRONIX MAKATI #103 MJM BLDG, 650 JP RIZAL ST, BRGY. VALENZUELA MAKATI CITY
TEL: 710-1980 / 949-3684 MOBILE: 0932-1999085

TRONIX MARIKINA #572 J.P. RIZAL AVE, CONCEPCION 1, MARIKINA (IN FRONT OF KSERVICO)
TEL: 696-6411 MOBILE: 0942-0940088

TRONIX PASIG LOWER GROUND SERVICE LANE, SM CENTER, PASIG
TEL: 703-5599 / 234-9020 MOBILE: 0932-1999372 CONTACT PERSON: MS. NORA CRESENCIO

TRONIX SHAW - MANDALUYONG #412 SHAW BLVD, COR. TORRES & CALDERON ST, MANDALUYONG CITY
TEL: 542-8360 / 725-7290 MOBILE: 0923-1646350 CONTACT PERSON: MS. SHERLY DELA CRUZ

TRONIX COMMONWEALTH LAGMANLAG COMMONWEALTH AVE, HOLY SPIRIT, DILIMAN, Q.C. (BESIDE SHELL)
TEL: 623-7266 MOBILE: 0933-6584465 / 09175810546 CONTACT PERSON: MR. MANNY SAGAYAP

CAVITE

TRONIX CAVITE KM 16, AGUINALDO HI-WAY, NIOG 1-A, PANAPAAN 1, BACOR, CAVITE
TEL: (046) 519-0755 / (046) 475-6362 MOBILE: 0932-1991811 CONTACT PERSON: MS. MEANN DIONISIO

CEBU

MARKWELL ENTERPRISES #85 SIKATUNA ST, CEBU CITY
TEL: (032) 253-0752 MOBILE: 0917-6256934 CONTACT PERSON: MR. BOY SOUICO

BIO PLUS ELEC. REPAIR CENTER C. PADILLA ST, SAN ROQUE, MAMBALING, CEBU CITY
TEL: (032) 262-1339 MOBILE: 0922-4744991 CONTACT PERSON: MS. ZYSELDA MABUTE

DAVAO

KOOL EXPRESS DOOR 5, LUA BLDG, QUIRINO AVE, DAVAO CITY
TEL: (082) 227-6369 MOBILE: 0908-420-6303 CONTACT PERSON: MS. DORIS ASIRIT

ILOILO

NACES APPLIANCE CORPORATION NACES BLDG, #10 DELGADO ST, ILOILO
TEL: (033) 337-7696 MOBILE: (033) 508-2205 CONTACT PERSON: MS. LORELIE LIM

TARLAC

TARLAC MAC ENTERPRISES INC. BLK. 9, MCARTHUR HIGHWAY, SAN NICOLAS, TARLAC
TEL: (045) 982-3178 MOBILE: 0922-8597136



ELECTRIC OVEN

MODEL # KW-3335

Voltage: 230Va.c. 60Hz Power: 2000 WATTS



INSTRUCTION MANUAL

CONGRATULATIONS

You are now a proud new owner of a KYOWA Electric Oven model no. KW-3335.

Before using for the first time, kindly take time to carefully read your instruction manual. Please observe all safety precautions and follow operating procedures. After reading, kindly store your instruction manual in a safe place for your future reference. Should you pass on this Electric Oven to a third party, please hand over this instruction manual as well.

PARTS DESCRIPTION

1. DOOR HANDLE
2. GLASS WINDOW
3. BAKING PAN
4. BAKING RACK
5. DOOR FRAME
6. OUTER BODY
7. TEMPERATURE KNOB
8. FUNCTION KNOB
9. TIMER KNOB
10. INDICATOR LIGHT
11. RUBBER FOOTING
12. CRUMB TRAY
13. PAN HANDLE
14. ROTISSERIE HANDLE
15. ROTISSERIE SPIT

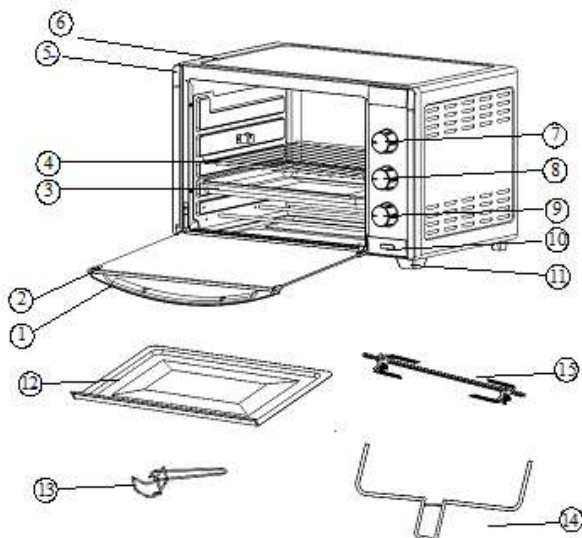







IMPORTANT SAFEGUARDS

When using your Electric Oven, basic safety precautions should always be followed:

- Always operate your KYOWA Electric Oven from a power source of the same voltage and frequency rating as indicated on the rating label.
- Place the Electric Oven on a flat surface and far from the edge of counter top.
- Do not use or replace accessories of the Electric Oven other than the ones originally provided.
- Allow 1 inch of space on all sides of the oven for proper ventilation.
- Do not operate the Electric Oven if any part of it including the supply cord has been damaged. Return the appliance to the nearest authorized dealer or service facility for repair.
- Do not operate or place any part of your Electric Oven on or near any hot surface such as a gas or electric burner, hotplate or heated oven.
- Use caution when using food containers inside the oven.
- Never put cardboard, plastic, paper, and other similar materials inside the Electric Oven.
- Avoid touching hot surfaces of the oven during use. Use the handle only.
- Always wear insulated oven gloves when placing or removing items from the oven.
- Do not cover any part of the oven with metal foil to avoid overheating of the unit.
- This Kyowa Electric Oven is not intended to be used with an external timer or a separate remote control system.
- Never leave the Electric Oven unattended when in use.
- Hold plug when unplugging from socket. Do not unplug by pulling the supply cord.
- Switch OFF and unplug the Electric Oven from outlet when not in use or before cleaning.
- To reduce the risk of electric shock, do not immerse or expose the Electric Oven to rain, moisture or any liquid.
- This appliance is not intended for use by persons (including children) with reduced physical, sensory or mental capabilities, lack of experience and knowledge, unless they have been given supervision or instruction concerning use of the appliance by a person responsible for their safety.
- Children should be supervised to ensure that they do not play with the appliance.
- This KYOWA Electric Oven is intended for normal domestic/household use only. This model is not suitable for commercial use.

UTENSIL AND OVEN CONTROL FUNCTIONS

- **Function Knob:** Allows you to select Heater Setting for a variety of cooking needs:
 - Upper/Lower Heating Element  or 
 - Upper & Lower Heating Element 
 - Upper Heating Element + Rotisserie  or 
 - Upper and Lower Heating Element + Rotisserie 
- **Temperature Knob:** Used to select desired temperature from 100°C to 230°C.
- **Timer Knob:** Allows you to set cooking time from 1 to 60 minutes for timed cooking function; set to ON position for untimed cooking function.
- **Indicator Light:** Illuminates whenever the unit is turned to ON.
- **Baking Pan/Baking Rack:** For toasting, baking, roasting, and general cooking in casserole dishes and standard pans.
- **Pan Handle:** Allows you to pick up Baking Pan and Baking Rack.
- **Rotisserie Spit:** Used when roasting variety of meats and poultry.
- **Rotisserie Handle:** Allows you to pick up Rotisserie Spit.

HOW TO USE

- Remove all packaging materials from the Electric Oven. Completely untangle or unwind the power cable of the oven.
- Plug Electric Oven into the power socket and operate at MAX temperature for about 15 minutes. Some parts of the Electric Oven have been slightly greased and as a result, the oven might slightly emit smoke when connected for the first time. This however, will cease after you have used the oven for some time.
- Turn Function Knob to the desired or required Heater Switch.
- Place food to be cooked in the food Tray then place into the Grill Rack inside the oven.
- To use rotisserie: insert pointed end of rotisserie rod through fork, making sure pointed ends of fork face same direction as pointed end of rod. Slide fork towards the other end of rod and secure with thumbscrew. Place food to be cooked on rod by running rod directly through center of food. Place second fork into other end of roast or poultry, secure with thumbscrew. Insert pointed end of rod into drive socket located on right-hand side of oven wall. Make sure the square end of rod rest on rotisserie

spit support, located on left-hand side the of oven wall. Place Food Tray in the bottom part inside the oven to catch oil drippings.

- Select desired temperature by turning temperature dial clockwise.
- Turn timer knob clockwise to desired cooking time, or turn counter-clockwise to ON position for untimed cooking function.
- Turn Heater/Function Knob to the desired heater setting.
*TIP: For fast roasting of meat or poultry, select the upper + rotisserie heating element setting.
- Check or remove food from the oven by using bake pan support or rotisserie handle.

CLEAN AND CARE

- Wipe external parts of the Electric Oven using a soft, damp cloth and a mild detergent.
- Avoid water or any other liquids to seep into the Control Panel of the oven.
- Cooking accessories such as trays and handles of the oven may be washed in warm, soapy water.
- Wipe dry the unit with a soft and dry cloth.
- Do not use harsh cleaning agents or abrasive objects (e.g. scrubbing pads or metal brushes) for cleaning.
- Put back parts and accessories of the Electric Oven to their proper places before operating again.
- Store oven in a cool and dry place.

SERVICE

- Do not operate your KYOWA Electric Oven if the oven malfunctions or appears damaged in any manner. Bring the complete product to the place of purchase or to any authorized KYOWA dealers for inspection, repair or replacement.
- Do not disassemble your KYOWA Electric Oven by yourself. No user serviceable parts inside. Refer all needed repair to an authorized KYOWA service facility ONLY.