

KYOWA SERVICE CENTER (MAIN)

RM. 1203, STATE CENTER BLDG, #333 JUAN LUNA ST, BINONDO MANILA
TEL: 242-1731 - 35

METRO MANILA

TRONIX QUEZON CITY (MAIN) #777 N.S. AMORANTO ST, COR. STO. DOMINGO AVE, Q.C.
TEL: 743-9094 / 749-8477 MOBILE: 0922-8534797/0917-5231489 CONTACT PERSON: MS. JENIELYN MANZANO

TRONIX MANILA #1793 CONCEPCION AGUILA ST, NEAR J.P. LAUREL ST, SAN MIGUEL, MANILA (NEAR MALACANANG)
TEL: 743-4088 MOBILE: 0922-7909555 CONTACT PERSON: MS. ANALEN FIADACAN

TRONIX STA. CRUZ #910 LUZON ST. (BET. MASANGKAY & BENAVIDEZ ST.) STA. CRUZ, MANILA
TEL: 542-8345 / 310-3553 MOBILE: 0922-2389971 CONTACT PERSON: MS. SHEILA PIRANTE

TRONIX SAN JUAN #135 N.DOMINGO ST, CORNER PINAGLABANAN, BRGY. BALONG BATO, SAN JUAN CITY
TEL: 949-3608 / 984-6395 MOBILE: 0922-9218653 CONTACT PERSON: MS. MICHELLE CASAÑA

TRONIX ALABANG TOWN CENTER LA-7 SERVICE TOWN, ALABANG TOWN CENTER, MUNTINLUPA CITY
TEL: 807-3546 / 624-6880 MOBILE: 0922-7584917 / 0917-5899059 CONTACT PERSON: MR. FRANCIS ACOSTA

TRONIX PARAÑAQUE #103 CMSR BLDG, PHASE 1, 88 PRESIDENT AVENUE, BF HOME, PARAÑAQUE
TEL: 622-4540 / 861-0092 / 828-2915 MOBILE: 0917-5978342 / 0932-4060806 CONTACT PERSON: MS. ELIZABETH PALIMA

TRONIX MAKATI #103 MJM BLDG, 650 JP RIZAL ST, BRGY. VALENZUELA MAKATI CITY
TEL: 710-1980 / 949-3684 MOBILE: 0932-1999085

TRONIX MARIKINA #572 J.P. RIZAL AVE, CONCEPCION 1, MARIKINA (IN FRONT OF KSERVICO)
TEL: 696-6411 MOBILE: 0942-0940088

TRONIX PASIG LOWER GROUND SERVICE LANE, SM CENTER, PASIG
TEL: 703-5599 / 234-9020 MOBILE: 0932-1999372 CONTACT PERSON: MS. NORA CRESENCIO

TRONIX SHAW - MANDALUYONG #412 SHAW BLVD, COR. TORRES & CALDERON ST, MANDALUYONG CITY
TEL: 542-8360 / 725-7290 MOBILE: 0923-1646350 CONTACT PERSON: MS. SHERLY DELA CRUZ

TRONIX COMMONWEALTH LAGMANLAG COMMONWEALTH AVE, HOLY SPIRIT, DILIMAN, Q.C. (BESIDE SHELL)
TEL: 623-7266 MOBILE: 0933-6584465 / 09175810546 CONTACT PERSON: MR. MANNY SAGAYAP

CAVITE

TRONIX CAVITE KM 16, AGUINALDO HI-WAY, NIOG 1-A, PANAPAAN 1, BACOR, CAVITE
TEL: (046) 519-0755 / (046) 475-6362 MOBILE: 0932-1991811 CONTACT PERSON: MS. MEANN DIONISIO

CEBU

MARKWELL ENTERPRISES #85 SIKATUNA ST, CEBU CITY
TEL: (032) 253-0752 MOBILE: 0917-6256934 CONTACT PERSON: MR. BOY SOUICO

BIO PLUS ELEC. REPAIR CENTER C. PADILLA ST, SAN ROQUE, MAMBALING, CEBU CITY
TEL: (032) 262-1339 MOBILE: 0922-4744991 CONTACT PERSON: MS. ZYSELDA MABUTE

DAVAO

KOOL EXPRESS DOOR 5, LUA BLDG, QUIRINO AVE, DAVAO CITY
TEL: (082) 227-6369 MOBILE: 0908-420-6303 CONTACT PERSON: MS. DORIS ASIRIT

ILOILO

NACES APPLIANCE CORPORATION NACES BLDG, #10 DELGADO ST, ILOILO
TEL: (033) 337-7696 MOBILE: (033) 508-2205 CONTACT PERSON: MS. LORELIE LIM

TARLAC

TARLAC MAC ENTERPRISES INC. BLK. 9, MCARTHUR HIGHWAY, SAN NICOLAS, TARLAC
TEL: (045) 982-3178 MOBILE: 0922-8597136



RICE COOKER

MODEL # KW-2062

Voltage: 230V a.c. 60Hz Power: 400 WATTS



INSTRUCTION MANUAL

CONGRATULATIONS

You are now a proud new owner of a KYOWA Rice Cooker model no. KW-2062.

Before using for the first time, kindly take time to carefully read your instruction manual. Please observe all safety precautions and follow operating procedures. After reading, kindly store your instruction manual in a safe place for your future reference. Should you pass on this Rice Cooker to a third party, please hand over this instruction manual as well.

PARTS DESCRIPTION

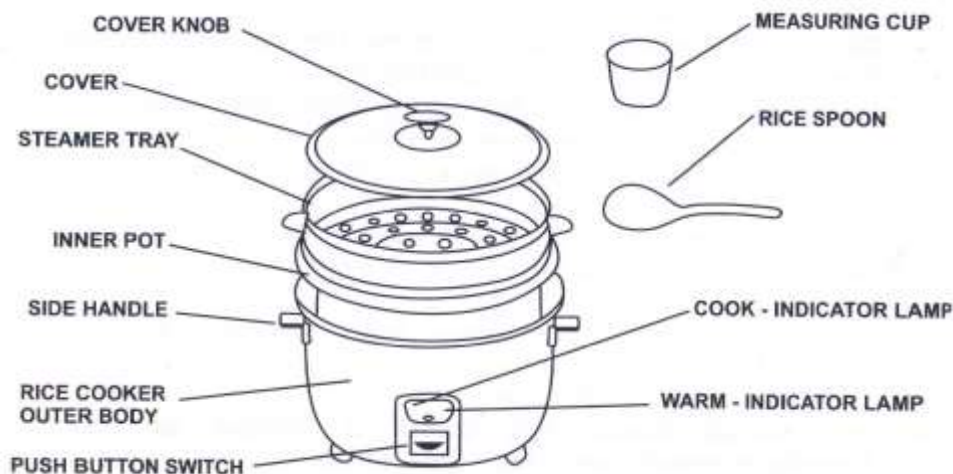

IMPORTANT SAFEGUARDS

When using your Rice Cooker, basic safety precautions should always be followed:

- Always operate your KYOWA Rice Cooker from a power source of the same voltage and frequency rating as indicated on the rating label.
- Connect the Rice Cooker unit only to properly wired wall outlets.
- Place the Rice Cooker on a flat surface and far from the edge of counter top.
- Keep at least 1 inch of space between the Rice Cooker and the wall for proper ventilation.
- Do not operate the Rice Cooker if any part of it has been damaged. Return the appliance to the nearest authorized dealer or service facility for repair.
- Do not operate or place any part of your Rice Cooker on or near any hot surface such as a gas or electric burner, hotplate or heated oven.
- Do not use or replace accessories of the Rice Cooker other than the ones originally provided.
- Do not operate Rice Cooker if the inner pot is empty.
- Some parts of the Rice Cooker have been slightly greased and as a result, the cooker might slightly emit smoke when connected for the first time. This however, will cease after you have used the unit for some time.
- Avoid touching hot surfaces of the cooker during use. Use the handle only.
- Switch OFF and unplug the Rice Cooker from outlet when not in use or before cleaning.
- Hold plug when unplugging from socket. Do not unplug by pulling the supply cord.
- Use caution when removing pot from the Rice Cooker after operation.
- To reduce the risk of electric shock, do not immerse or expose the Rice Cooker to rain, moisture or any liquid.
- The appliance is not to be used by persons (including children) with reduced physical, sensory or mental capabilities, or lack of experience and knowledge, unless they have been given supervision or instruction
- This KYOWA Rice Cooker is intended for normal domestic/household use only. This model is not suitable for commercial use.

HOW TO USE

- Wash rice grains in a separate container. Do not use the inner pot for washing rice to prevent it from getting deformed or scratched.
- Transfer rice into the inner pot. Always fill in pot with enough rice and water reaching the MIN mark but not exceeding the MAX marking.
- Put enough water into the pot to cover rice. Pour one cup of water for every cup of rice – this however depends on the type of rice used and as well as to personal preference when cooking.
- Place inner pot into the cooker. See to it that the base of the inner pot is dry and clean.
- Plug in power cord into the rice cooker unit making sure that it is firmly set in place.
- Plug the other end of the power cord into the power supply.
- Press down switch to turn the unit ON. COOK indicator light shall illuminate to indicate that the unit is working.
- Rice cooker will automatically switch to WARM once the rice is cooked already; WARM indicator lamp will then light up.
- Allow rice to sit for about 15 minutes before serving.
- Unplug power cord from the power supply when not in use or if you are not intending to use the keep warm function of the cooker.



CLEAN AND CARE

- Allow Rice Cooker to cool down completely before cleaning.
- Wash inner pot with warm water and a mild dishwashing soap.
- To remove rice residue in the pot, soak it with warm soapy water overnight then rinse.
- Do not use harsh cleaning agents or abrasive objects (e.g. scrubbing pads or metal brushes) for cleaning.
- Clean outer surfaces of the Rice Cooker with a soft and damp cloth.
- Wipe dry Rice Cooker with a soft and dry cloth then store in a clean and dry place.
- Put back parts and accessories of the Rice Cooker to their proper places before operating again.

SERVICE

- Do not operate your KYOWA Rice Cooker if the rice cooker malfunctions or appears damaged in any manner. Bring the complete product to the place of purchase or to any authorized KYOWA dealers for inspection, repair or replacement.
- Do not disassemble your KYOWA Rice Cooker by yourself. No user serviceable parts inside. Refer all needed repair to an authorized KYOWA service facility ONLY.