

roomours

IF YOU  
NEVER  
TRY  
YOU'LL  
NEVER  
KNOW

**roomours product catalogue**  
2023



SMALL  
THINGS  
BECOME  
GREAT  
WHEN MADE  
WITH  
LOVE

#### **roomours - Tools for communication**

---

Our products stand for the highest quality craftsmanship and durable and functional design. Behind each of our tools is an idea. It has to take shape, assert itself and prove itself, time and time again. This agile way of working is in the DNA of our products - but above all in the self-image of our company. We place particular value on the personal proximity to our customers and the active exchange with our suppliers, which allows us to quickly and easily realize special requests and individual solutions - but above all on the exciting dialog with the users of our products all over the world.

#### **Form, function and finish**

---

Consciously, our products are based on analog typologies: blackboard, easel, pinboard - made of wood and natural materials. We want to create a relationship between people and their work tools.

We continue to develop and optimize our tools with our finger on the pulse of time. Today, they also provide a foundation for agile and creative work, for virtual meetings and video conferences - and always meet our standards: functional and beautiful, high-quality and intuitive to use. roomours communication tools are carefully crafted pieces - coherent and practical tools for ideation processes, video conferences and collaborative work.

#### **Material and environment**

---

For our tools we use mainly solid wood in oak or ash from domestic cultivation which guarantees a long life and an honest aging process. After many years of use, our products could be sorted, disassembled and recycled - but so that this is not necessary, we still supply all components for products that you have purchased from us.





### Powder coated steel

It can be coated in different colors without solvents, is durable and long-lasting and can be recycled after a long service life.

**Writable:** The white boards can be written on with whiteboard markers and dry-wiped.



RAL 9005

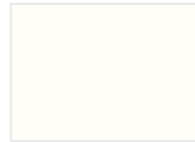

RAL 9016



RAL 7030



RAL 7004



RAL 6019



RAL 6018



RAL 6005



RAL 5024



RAL 3020



RAL 3015



RAL 2000



RAL 1018



### High quality solid wood

Wood is a natural material that makes each product unique due to its structure. At the same time, it ages gracefully and darkens slightly over time. The finish with natural oil gives the surface a slightly silky sheen.

**Environmentally friendly:** renewable and particularly durable raw material.

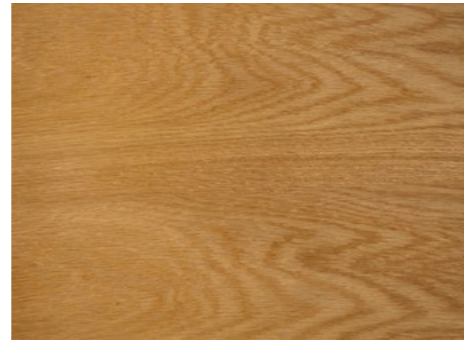

Oak nature, oiled



Ash nature, oiled

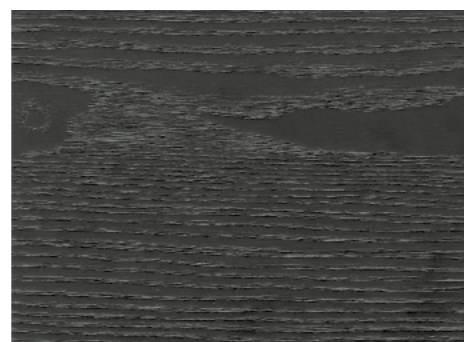

Ash, stained black



### Durable boards

The surfaces of Write It on Tour and Chalk Talk are provided with a writable HPL coating and color-matching edge - an internal metal layer also makes the board particularly magnetic.

**Cleaning:** The white coating is writable with whiteboard markers and can be cleaned wet or dry. The dark coatings are writable with chalk or chalk markers and should be cleaned wet

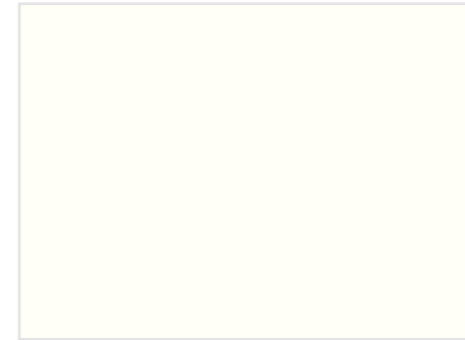

Signal white RAL 9003



Green, ähnlich RAL 6028



Black, similar RAL 7021



### ESG safety glass

With light tinting in gray, blue or green, the glass boards are always an eye-catcher and still offer sufficient transparency and view despite shielding. ESG glass is very robust and inherently rigid - and is very well suited to light separation. The glass boards can be written on with special glass board markers.

**Cleaning:** Our gasboards can be cleaned very well with water and household cleaners.



Green, transparent



Blue, transparent



Grey, transparent



### Lightweight Materials

Stiff lightweight boards with a resin-impregnated top layer on both sides and a polystyrene foam core. The boards are very easy to pin - pins leave only a small hole, which is hardly visible on the black board. Surface: matt and paper-like.

**Surface:** Matt, Paper-like



Black



White



### Recycled Fleece

PES (polyester, thermoplastic high-performance plastic), contains about 70% already recyclable material and is 100% recyclable and slightly acoustically effective. The material is pinable. The pins leave hardly visible holes in the fleece.



Grey, mottled



### Merino wool felt

Undyed natural felt made of 100% merino wool - a very strong felt with a pleasant surface and with its 8 mm thickness very easy to pin, the needles leave no puncture marks after use.



Grey, mottled



### Table tops

Black through-dyed MDF with an anthracite HPL - Fenix coating (anti-fingerprint and high impact and scratch resistance, matt).

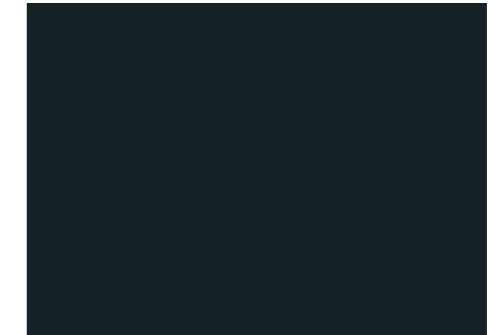

Black, similar RAL 7021

# Content

## Flipcharts

Charter	16
Foldable	20
The Wanderer	24
Charter on Tour	28
Flip It	34
Freewheelin'	38



## Tables

Link and Think	120
By your Side	122
Meet and Greet	124
Line Up	126

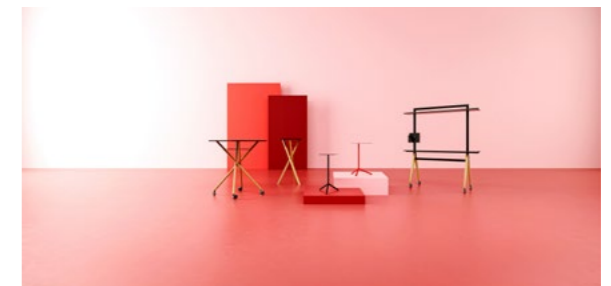

## Mobile Boards

Jack White on Tour	48
Write It on Tour	52
Pin Up on Tour	56
Glassworks	64
Chalk Talk	72
Shelf Tray	78
Pen Tray Keep It	82
Hold On	84
Post and Pin	86
Pinboard Line Up	92



## Storage

Toolbox	132
Mobile Shelf Line Up	134

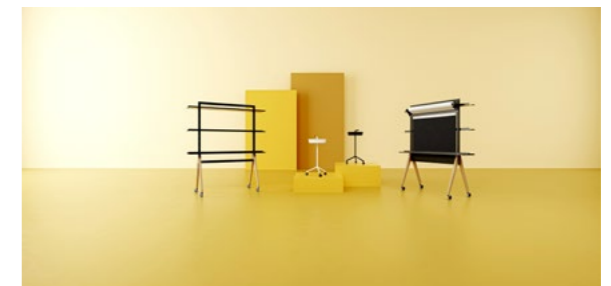

## TV Stands

Front Row	98
Line Up	106
Chatterbox	110



## Zubehör

Add ons Line Up	139
Stationery	141
Cleaning and Care	143

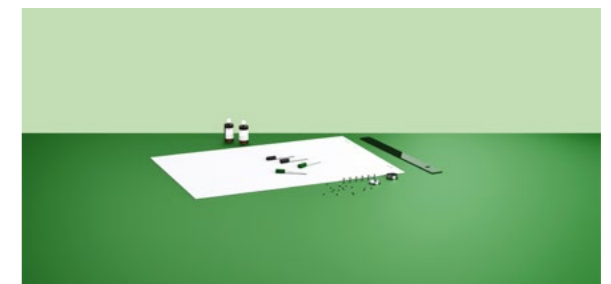



# Flipcharts

Whether in a coworking space, home office, hotel or agency - our flipcharts provoke creative exchange. Functional and clear in design, they integrate excellently into different room situations. The flipcharts are available in twelve different colors, in Ash or Oak, dynamically on casters, mobile and space-saving folded or rather classically stable - our flipcharts captivate with their characteristic design and enliven the morn office with their colors.

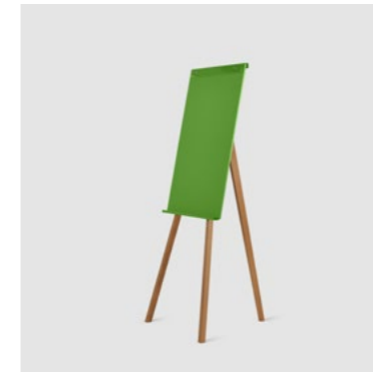

**Charter**  
classic flipchart

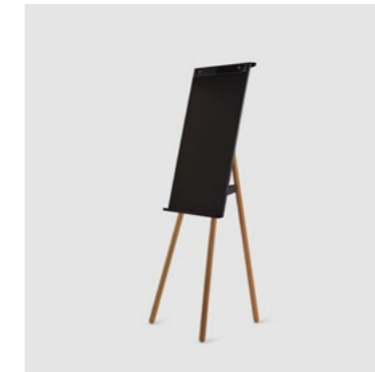

**Foldable**  
foldable flipchart



**The Wanderer**  
transportable Flipchart



**Charter on Tour**  
mobile flipchart



**Flip It**  
digital flipchart



**Freewheelin'**  
mobile flipchart



## Charter

The Charter flipchart is the award-winning classic among flipcharts. Clear in design, functional and already awarded for its outstanding design by the Design Center Baden-Württemberg and the German Design Council.

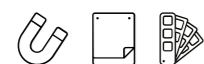

### Details

Dimensions HxWxD	180 x 78 x 76 cm
Surface board	71 cm x 102 cm
Weight	18 kg
Hole spacing block	50 cm

### Materials

Structure	Solid wood (Oak or Ash)
Board	Sheet steel, powder coated
Tear bar	Polycarbonat, transparent

### Shipping details

Volume shipping weight	40 kg
Packages	3
Shipping method	Freight forwarding

### Options

Colour Board

Woods

Desired color according to RAL color palette possible on request

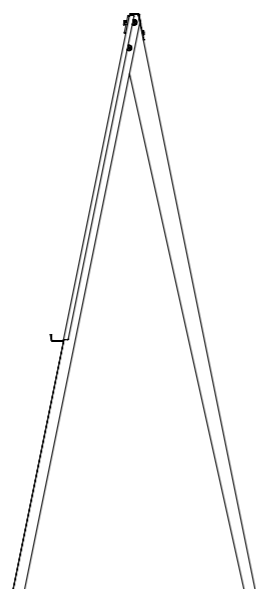
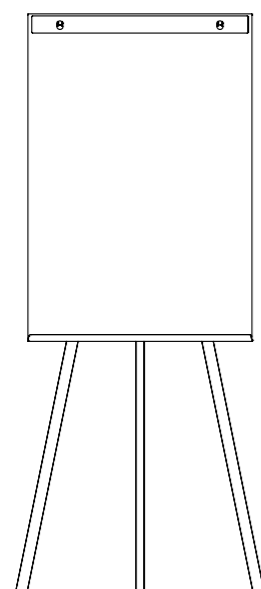



Article number	Wood	Colour Board	
FC-BK.O	Oak	Jet black RAL 9005	●
FC-GN.O	Oak	Yellow green RAL 6018	●
FC-MG.O	Oak	Mossgreen RAL 6005	●
FC-PB.O	Oak	Pastel blue RAL 5024	●
FC-PG.O	Oak	Pastel green RAL 6019	●
FC-RD.O	Oak	Traffic red RAL 3020	●
FC-RS.O	Oak	Light pink RAL 3015	●
FC-SG.O	Oak	Signal grey RAL 7004	●
FC-GR.O	Oak	Stone grey RAL 7030	●
FC-WT.O	Oak	Traffic white RAL 9016	○
FC-OR.O	Oak	Yellow orange RAL 2000	●
FC-YE.O	Oak	Zinc yellow RAL 1018	●

Article number	Wood	Colour Board	
FC-BK.A	Ash	Jet black RAL 9005	●
FC-GN.A	Ash	Yellow green RAL 6018	●
FC-MG.A	Ash	Mossgreen RAL 6005	●
FC-PB.A	Ash	Pastel blue RAL 5024	●
FC-PG.A	Ash	Pastel green RAL 6019	●
FC-RD.A	Ash	Traffic red RAL 3020	●
FC-RS.A	Ash	Light pink RAL 3015	●
FC-SG.A	Ash	Signal grey RAL 7004	●
FC-GR.A	Ash	Stone grey RAL 7030	●
FC-WT.A	Ash	Traffic white RAL 9016	○
FC-OR.A	Ash	Yellow orange RAL 2000	●
FC-YE.A	Ash	Zinc yellow RAL 1018	●

## 20 // FLIPCHARTS

### Foldable

Foldable is easy to move and convenient to store, if it should not be used after all. The middle of the three legs can be easily folded and fixed with a magnet -when folded Foldable has a depth of only 10 cm.



#### Details

Dimensions HxWxD	180 x 71 x 74 cm
Surface board	71 cm x 102 cm
Weight	16/18 kg
Hole spacing block	50 cm

#### Materials

Structure	Solid wood or aluminum
Board	Sheet steel, powder coated
Tear bar	Polycarbonat, transparent

#### Shipping details

Volume shipping weight	40 kg
Packages	1
Shipping method	Freight forwarding

#### Options

Colour Board

Structure

Desired color according to RAL color palette possible on request

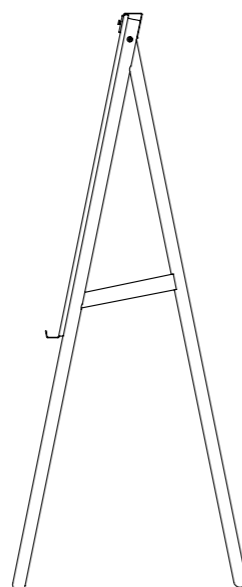
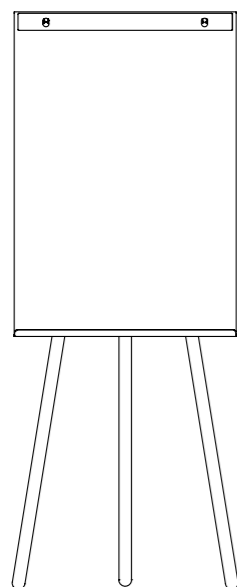

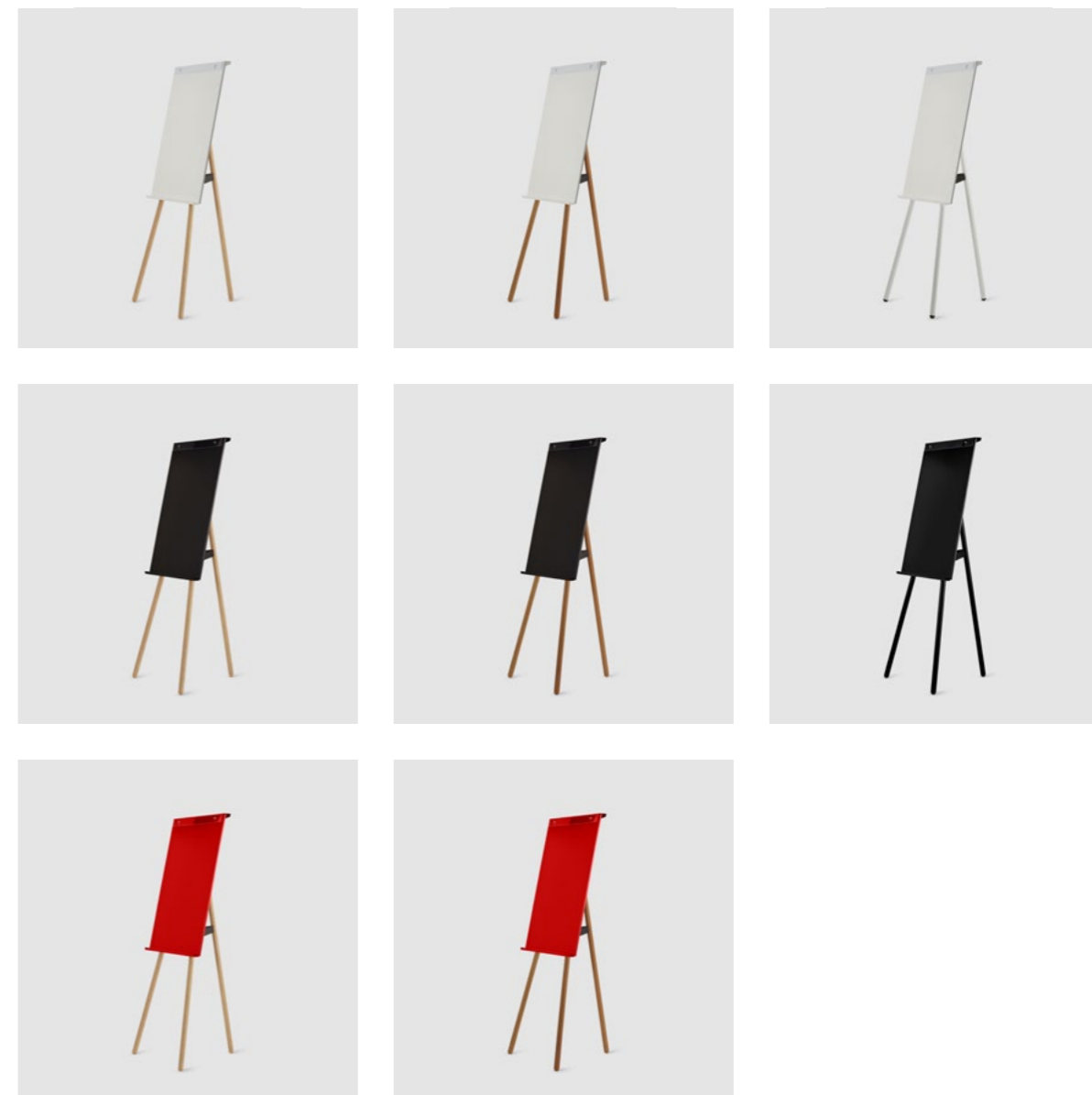

Article number	Structure	Colour Board	
FFA-WT.A	Ash	Traffic white RAL 9016	○
FFA-WT.O	Oak	Traffic white RAL 9016	○
FFA-WT	Alu	Traffic white RAL 9016	○
FFA-BK.A	Ash	Jet black RAL 9005	●
FFA-BK.O	Oak	Jet black RAL 9005	●
FFA-BK	Alu	Jet black RAL 9005	●
FFA-RD.A	Ash	Traffic red RAL 3020	●
FFA-RD.O	Oak	Traffic red RAL 3020	●

## The Wanderer

The tool for everyone who often works in different places in dialog with smaller teams. It folds up small and is easy to carry - whether slung over your shoulder on campus or on the road when working with different teams.



### Details

Frame folded H x W x D	180 x 20 x 20 cm
Rack erected H x W x D	180 x 70/100/140 x 70 cm
Weight	10 kg

### Materials

Structure	Solid wood (Oak / Ash)
Board	Gatorfoam

### Shipping details

Volume shipping weight	32 / 48 kg
Packages	2
Shipping method	Freight forwarding

### Options

Board size	70 x 100 cm, 140 x 100 cm
Colour Board	<input checked="" type="radio"/> <input type="radio"/>

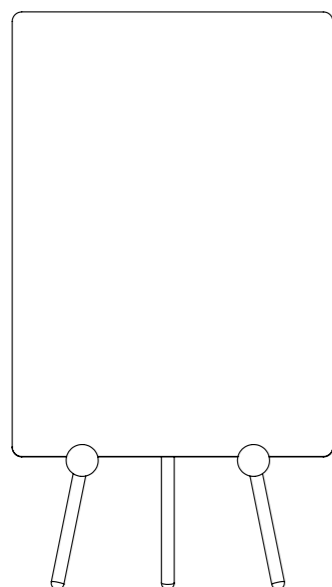

The Wanderer // 27

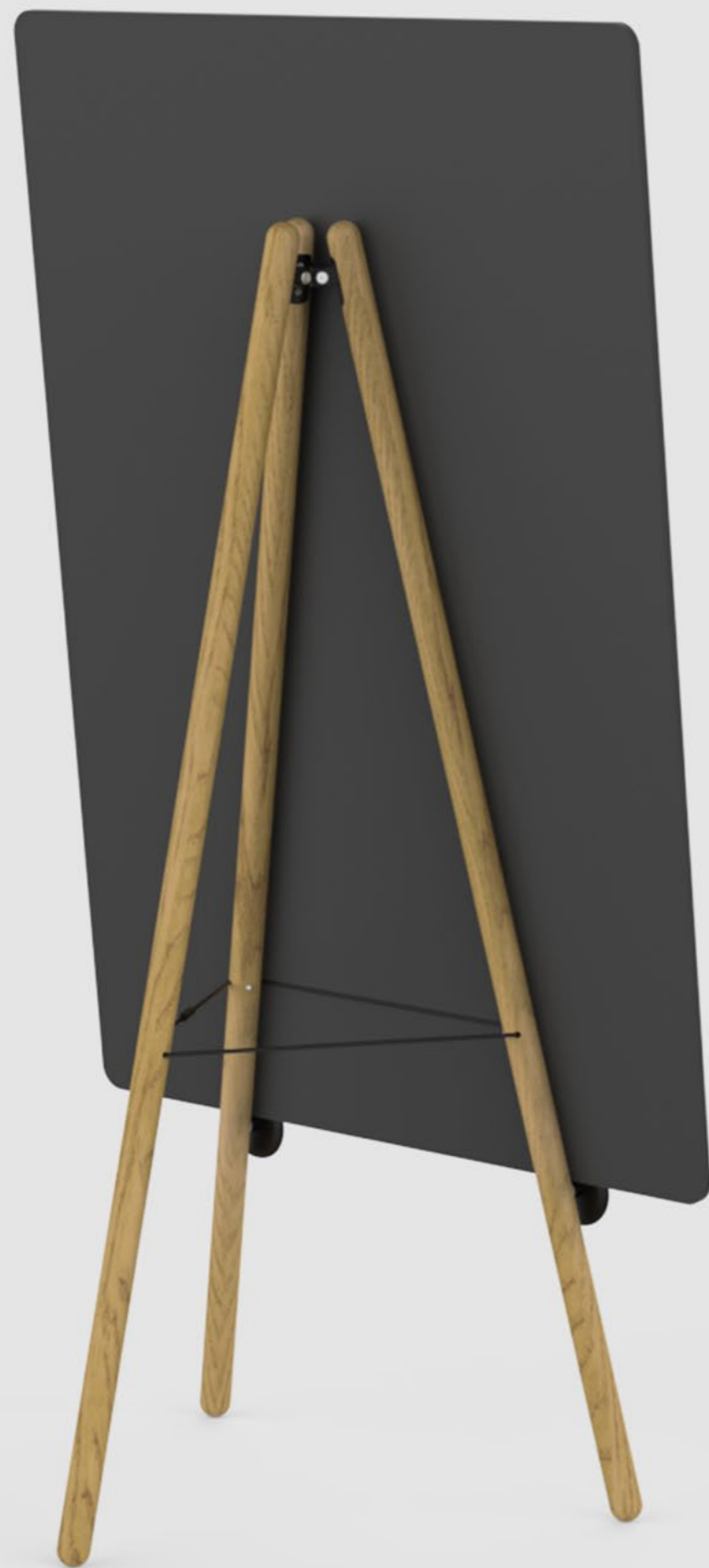

Article number	Board size H x W	Colour Board	Wood
FTW-GF-WT70.O	100 x 70 cm	White	Oak
FTW-GF-BK70.O	100 x 70 cm	Black	Oak
FTW-GF-WT140.O	140 x 100 cm	White	Oak
FTW-GF-BK140.O	140 x 100 cm	Black	Oak

## Charter on Tour

Charter on Tour is incredibly mobile, brings color into the meeting and thus promotes communication and creativity. The sides are made of oiled wood on four casters, two of which can be locked.



### Details

Dimensions HxWxD in cm	180 x 71 x 73
Surface board	71 cm x 102 cm
Weight	25 kg
Hole spacing block	50 cm

### Materials

Structure	Solid wood (Oak or Ash)
Board	Sheet steel, powder coated
Tear bar	Polycarbonat, transparent

### Shipping details

Volume shipping weight	45 kg
Packages	3
Shipping method	Freight forwarding

### Options

Colour Board	
Woods	
Castor colors	
Desired color according to RAL color palette possible on request	

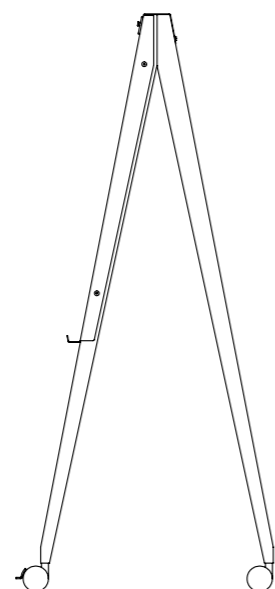
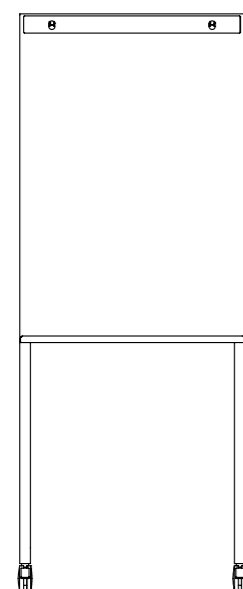



Article number	Wood	Castors	Colour Board	
FCoT-BK.O.1	Oak	White	Jet black RAL 9005	●
FCoT-GN.O.1	Oak	White	Yellow green RAL 6018	●
FCoT-MG.O.1	Oak	White	Mossgreen RAL 6005	●
FCoT-PB.O.1	Oak	White	Pastel blue RAL 5024	●
FCoT-PG.O.1	Oak	White	Pastel green RAL 6019	●
FCoT-RD.O.1	Oak	White	Traffic red RAL 3020	●
FCoT-RS.O.1	Oak	White	Light pink RAL 3015	●
FCoT-SG.O.1	Oak	White	Signal grey RAL 7004	●
FCoT-GR.O.1	Oak	White	Stone grey RAL 7030	●
FCoT-WT.O.1	Oak	White	Traffic white RAL 9016	○
FCoT-OR.O.1	Oak	White	Yellow orange RAL 2000	●
FCoT-YE.O.1	Oak	White	Zinc yellow RAL 1018	●

Article number	Wood	Castors	Colour Board	
FCoT-BK.O.2	Oak	Black	Jet black RAL 9005	●
FCoT-GN.O.2	Oak	Black	Yellow green RAL 6018	●
FCoT-MG.O.2	Oak	Black	Mossgreen RAL 6005	●
FCoT-PB.O.2	Oak	Black	Pastel blue RAL 5024	●
FCoT-PG.O.2	Oak	Black	Pastel green RAL 6019	●
FCoT-RD.O.2	Oak	Black	Traffic red RAL 3020	●
FCoT-RS.O.2	Oak	Black	Light pink RAL 3015	●
FCoT-SG.O.2	Oak	Black	Signal grey RAL 7004	●
FCoT-GR.O.2	Oak	Black	Stone grey 7030 9016	●
FCoT-WT.O.2	Oak	Black	Traffic white RAL 9016	○
FCoT-OR.O.2	Oak	Black	Yellow orange RAL 2000	●
FCoT-YE.O.2	Oak	Black	Zinc yellow RAL 1018	●





Article number	Wood	Castors	Colour Board	
FCoT-BK.A.1	Ash	White	Jet black RAL 9005	●
FCoT-GN.A.1	Ash	White	Yellow green RAL 6018	●
FCoT-MG.A.1	Ash	White	Mossgreen RAL 6005	●
FCoT-PB.A.1	Ash	White	Pastel blue RAL 5024	●
FCoT-PG.A.1	Ash	White	Pastel green RAL 6019	●
FCoT-RD.A.1	Ash	White	Traffic red RAL 3020	●
FCoT-RS.A.1	Ash	White	Light pink RAL 3015	●
FCoT-SG.A.1	Ash	White	Signal grey RAL 7004	●
FCoT-GR.A.1	Ash	White	Stone grey 7030 9016	●
FCoT-WT.A.1	Ash	White	Traffic white RAL 9016	○
FCoT-OR.A.1	Ash	White	Yellow orange RAL 2000	●
FCoT-YE.A.1	Ash	White	Zinc yellow RAL 1018	●

Article number	Wood	Castors	Colour Board	
FCoT-BK.A.2	Ash	Black	Jet black RAL 9005	●
FCoT-GN.A.2	Ash	Black	Yellow green RAL 6018	●
FCoT-MG.A.2	Ash	Black	Mossgreen RAL 6005	●
FCoT-PB.A.2	Ash	Black	Pastel blue RAL 5024	●
FCoT-PG.A.2	Ash	Black	Pastel green RAL 6019	●
FCoT-RD.A.2	Ash	Black	Traffic red RAL 3020	●
FCoT-RS.A.2	Ash	Black	Light pink RAL 3015	●
FCoT-SG.A.2	Ash	Black	Signal grey RAL 7004	●
FCoT-GR.A.2	Ash	Black	Stone grey RAL 7030	●
FCoT-WT.A.2	Ash	Black	Traffic white RAL 9016	○
FCoT-OR.A.2	Ash	Black	Yellow orange RAL 2000	●
FCoT-YE.A.2	Ash	Black	Zinc yellow RAL 1018	●

## Flip It

Flip It is designed so that the screen can be rotated clockwise by 90°. An integrated power strip with three sockets and a 3 or 5 meter power cable provides the necessary connectivity for various forms of digital collaboration. Flip It is especially suitable for the Samsung Flip 55" and 65" models.



### Details without display

Dimensions HxWxD in cm	180 x 72 x 70
Suitable for	Samsung Flip 2 55" and 65"
Weight	12 kg

### Materials

Structure	Solid wood Oak or Ash
Steel elements	Sheet steel, powder coated

### Shipping details

Volume shipping weight	38 kg
Packages	3
Shipping method	Freight forwarding

### Options

Wood	
Castor colors	

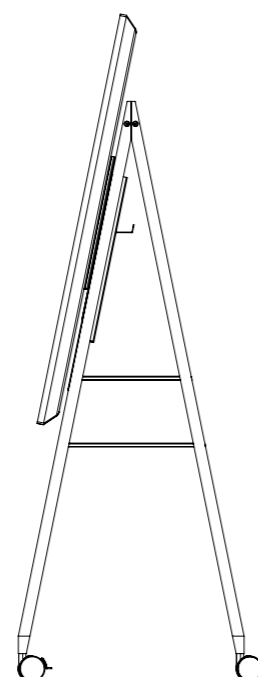
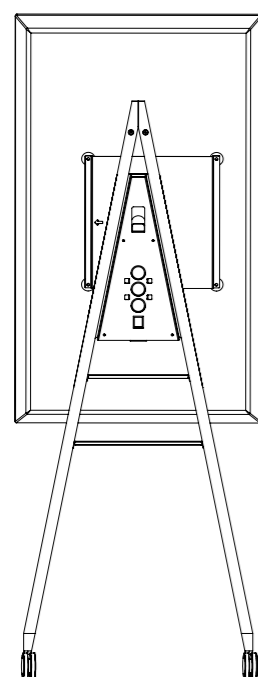

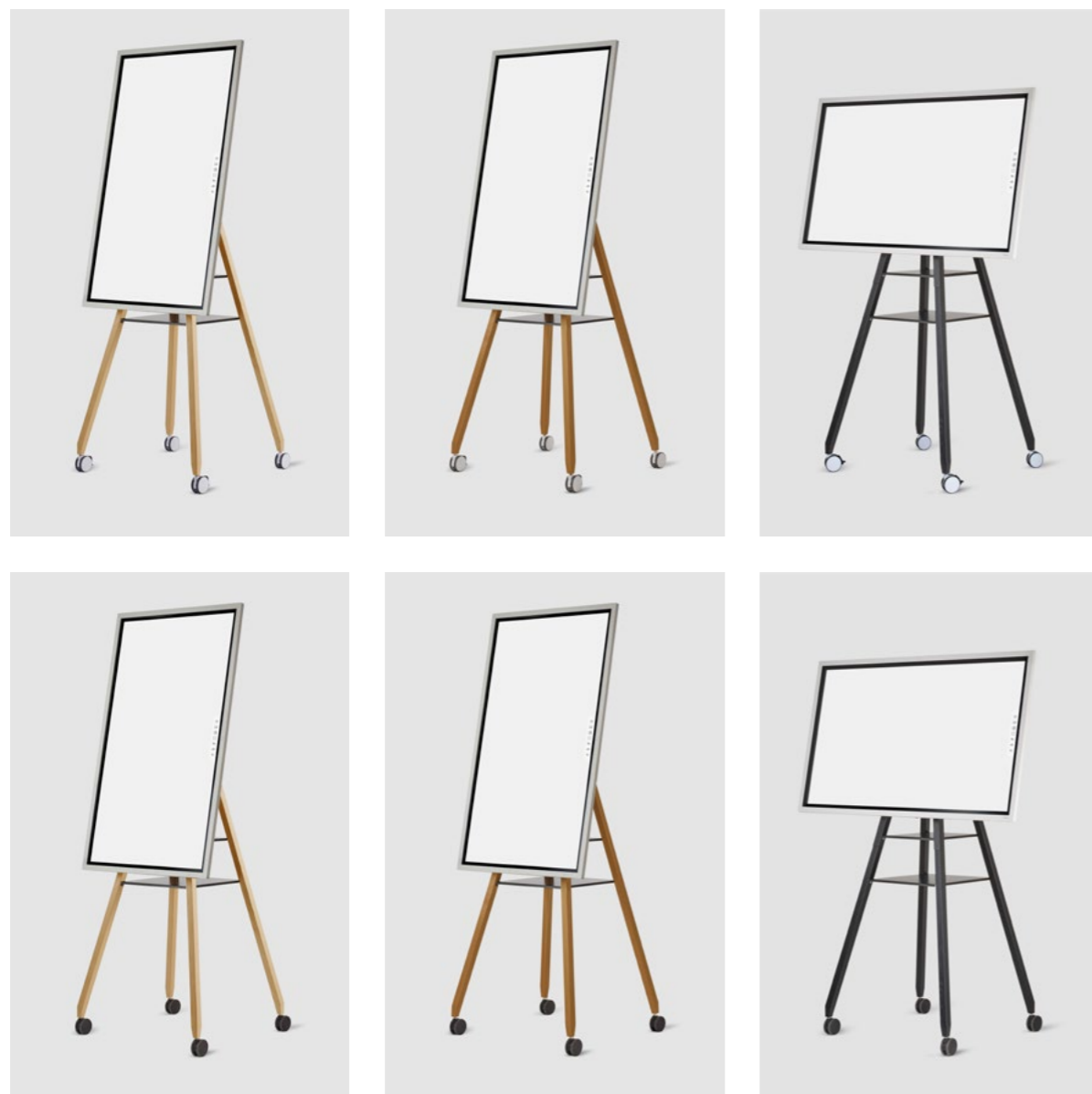

Article number	Wood	Castors
FI-BK.A.1	Ash	White
FI-BK.O.1	Oak	White
FI-BK.BK.1	Ash, stained black	White
FI-BK.A.2	Ash	Black
FI-BK.O.2	Oak	Black
FI-BK.BK.2	Ash, stained black	Black



## Freewheelin'

Freewheelin' provides dynamic communication in any workshop with its legs converging at a single point. A slim shelf provides additional storage space. The flipchart stands on an oiled wood structure with four castors - the front two are lockable.



### Details

Dimensions HxWxD	180 x 72 x 70 cm
Surface board HxB	71 cm x 102 cm
Weight	19 kg
Hole spacing block	50 cm

### Materials

Structure	Solid wood (Oak or Ash)
Board	Sheet steel, powder coated
Tear bar	Polycarbonat, transparent

### Shipping details

Volume shipping weight	43 kg
Packages	3
Shipping method	Freight forwarding

### Options

Colour Board	
Woods	
Castor colors	
Desired color according to RAL color palette possible on request	

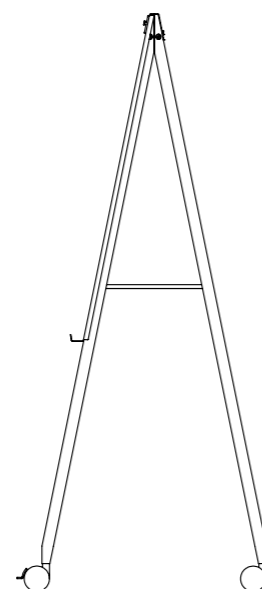
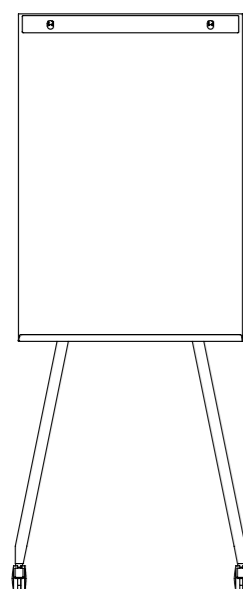



Article number	Wood	Castors	Colour Board	
FF-BK.O.1	Oak	White	Jet black RAL 9005	●
FF-GN.O.1	Oak	White	Yellow green RAL 6018	●
FF-MG.O.1	Oak	White	Mossgreen RAL 6005	●
FF-PB.O.1	Oak	White	Pastel blue RAL 5024	●
FF-PG.O.1	Oak	White	Pastel green RAL 6019	●
FF-RD.O.1	Oak	White	Traffic red RAL 3020	●
FF-RS.O.1	Oak	White	Light pink RAL 3015	●
FF-SG.O.1	Oak	White	Signal grey RAL 7004	●
FF-GR.O.1	Oak	White	Stone grey 7030 9016	●
FF-WT.O.1	Oak	White	Traffic white RAL 9016	○
FF-OR.O.1	Oak	White	Yellow orange RAL 2000	●
FF-YE.O.1	Oak	White	Zinc yellow RAL 1018	●

Article number	Wood	Castors	Colour Board	
FF-BK.O.2	Oak	Black	Jet black RAL 9005	●
FF-GN.O.2	Oak	Black	Yellow green RAL 6018	●
FF-MG.O.2	Oak	Black	Mossgreen RAL 6005	●
FF-PB.O.2	Oak	Black	Pastel blue RAL 5024	●
FF-PG.O.2	Oak	Black	Pastel green RAL 6019	●
FF-RD.O.2	Oak	Black	Traffic red RAL 3020	●
FF-RS.O.2	Oak	Black	Light pink RAL 3015	●
FF-SG.O.2	Oak	Black	Signal grey RAL 7004	●
FF-GR.O.2	Oak	Black	Stone grey 7030 9016	●
FF-WT.O.2	Oak	Black	Traffic white RAL 9016	○
FF-OR.O.2	Oak	Black	Yellow orange RAL 2000	●
FF-YE.O.2	Oak	Black	Zinc yellow RAL 1018	●



Article number	Wood	Castors	Colour Board	
FF-BK.A.1	Ash	White	Jet black RAL 9005	●
FF-GN.A.1	Ash	White	Yellow green RAL 6018	●
FF-MG.A.1	Ash	White	Mossgreen RAL 6005	●
FF-PB.A.1	Ash	White	Pastel blue RAL 5024	●
FF-PG.A.1	Ash	White	Pastel green RAL 6019	●
FF-RD.A.1	Ash	White	Traffic red RAL 3020	●
FF-RS.A.1	Ash	White	Light pink RAL 3015	●
FF-SG.A.1	Ash	White	Signal grey RAL 7004	●
FF-GR.A.1	Ash	White	Stone grey RAL 7030	●
FF-WT.A.1	Ash	White	Traffic white RAL 9016	○
FF-OR.A.1	Ash	White	Yellow orange RAL 2000	●
FF-YE.A.1	Ash	White	Zinc yellow RAL 1018	●

Article number	Wood	Castors	Colour Board	
FF-BK.A.2	Ash	Black	Jet black RAL 9005	●
FF-GN.A.2	Ash	Black	Yellow green RAL 6018	●
FF-MG.A.2	Ash	Black	Mossgreen RAL 6005	●
FF-PB.A.2	Ash	Black	Pastel blue RAL 5024	●
FF-PG.A.2	Ash	Black	Pastel green RAL 6019	●
FF-RD.A.2	Ash	Black	Traffic red RAL 3020	●
FF-RS.A.2	Ash	Black	Light pink RAL 3015	●
FF-SG.A.2	Ash	Black	Signal grey RAL 7004	●
FF-GR.A.2	Ash	Black	Stone grey RAL 7030	●
FF-WT.A.2	Ash	Black	Traffic white RAL 9016	○
FF-OR.A.2	Ash	Black	Yellow orange RAL 2000	●
FF-YE.A.2	Ash	Black	Zinc yellow RAL 1018	●



# Mobile Boards

Present, moderate, structure. Whether as the basis for equipping design thinking spaces or as magnetic kanban boards for agile teams - a presentation wall is often at the heart of teamwork. This is where ideas and ultimately strategies are developed. To accompany these creative processes, it is a good idea to use presentation walls and thereby make thoughts and processes comprehensible. Our mobile presentation walls are open for your ideas. The panels and boards in various designs provide the framework for your concepts - made of different materials, but always with legs made of solid wood - mobile, stable and timeless. Convince yourself of our presentation walls with their natural character, their variety of materials and their high design standards.

This makes working fun!



**Jack White on Tour**  
with optional  
Flipchart suspension

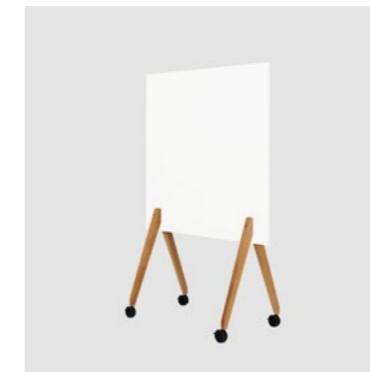

**Write It on Tour**  
magnetic and double-sided  
writable



**Pin Up on Tour**  
magnetic, writable  
and pinable (white)

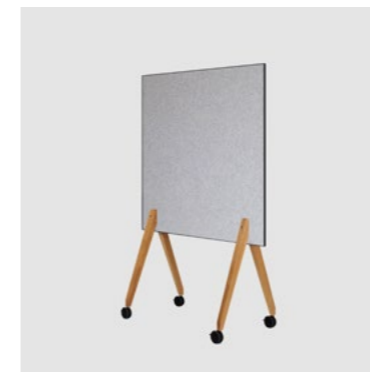

**Pin Up on Tour**  
magnetic, writable (Black)

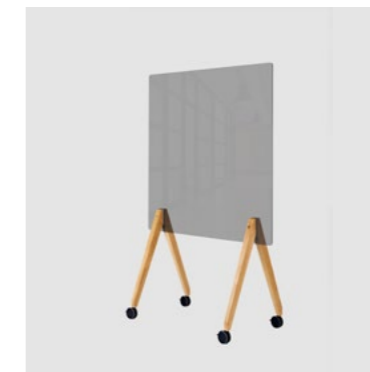

**Glassworks**  
lightly tinted,  
transparent glass pane

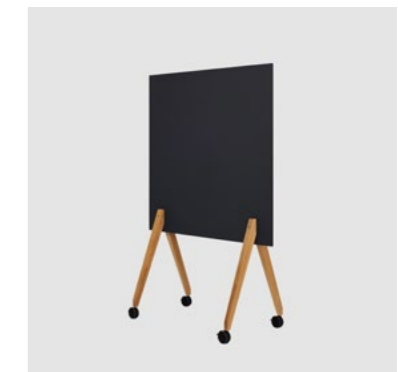

**Chalk Talk**  
magnetic and double-sided  
writable

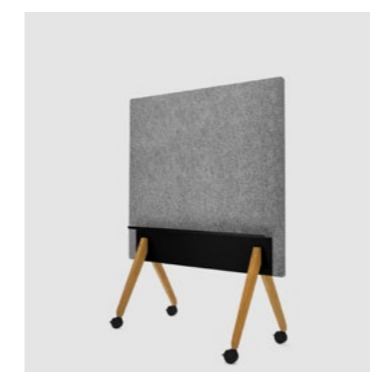

**Post and Pin**  
the basis for  
individual materials



**Line Up**  
modular, flexible  
and expandable



## Jack White on Tour

Magnets, sticky notes or whiteboard markers - Jack White on Tour takes on a lot. Be it as a generous whiteboard or as a surface offer for one or two flipchart pads - aligned to your individual way of working.



### Details

Dimensions HxWxD in cm	180 x 140 x 73
Surface board HxB in cm	102cm x 140 cm
Weight	32 kg
Hole spacing block	50 cm

### Materials

Structure	Solid wood (Oak or Ash)
Board	Sheet steel, powder coated (RAL9016)
Tear bar	Polycarbonat, transparent

### Shipping details

Volume shipping weight	75 kg
Packages	3
Shipping method	Freight forwarding

### Options

Flipchart pad	without, right, left, right and left
Woods	
Castor colors	

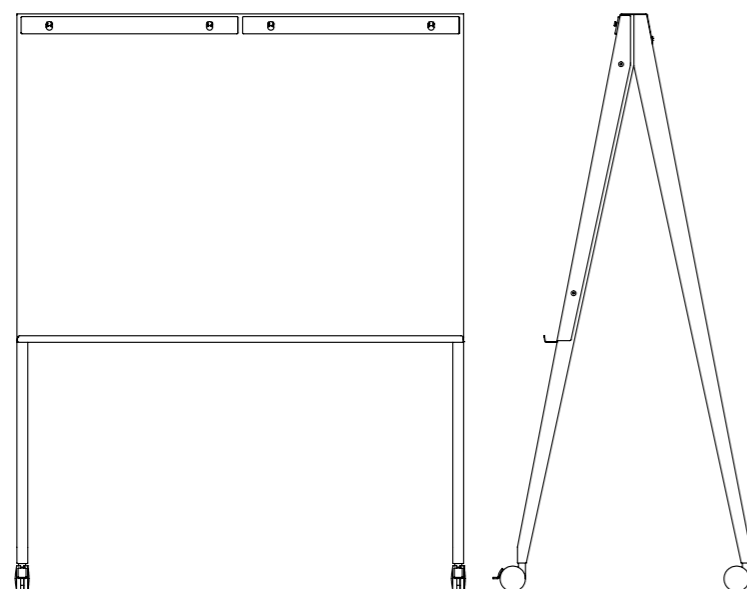



Article number	Wood	Flipchart suspension	Castors
JWōT-WT.A.1	Ash	none	White
JWōT-WT.A.1.1PL	Ash	left	White
JWōT-WT.A.1.1PR	Ash	right	White
JWōT-WT.A.1.2PLR	Ash	left and right	White
JWōT-WT.A.2	Ash	none	Black
JWōT-WT.A.2.1PL	Ash	left	Black
JWōT-WT.A.2.1PR	Ash	right	Black
JWōT-WT.A.2.2PLR	Ash	left and right	Black
JWōT-WT.O.1	Oak	none	White
JWōT-WT.O.1.1PL	Oak	left	White
JWōT-WT.O.1.1PR	Oak	right	White
JWōT-WT.O.1.2PLR	Oak	left and right	White
JWōT-WT.O.2	Oak	none	Black
JWōT-WT.O.2.1PL	Oak	left	Black
JWōT-WT.O.2.1PR	Oak	right	Black
JWōT-WT.O.2.2PLR	Oak	left and right	Black

## Write It on Tour

Writable on both sides and also usable for magnetic attachment, Write It on Tour is a wonderfully mobile and at the same time very stable and high-quality writing board. Ideas, sketches, graphics - Write It on Tour is a tribute to the fine art of handwriting.



### Details

Dimensions HxWxD	180 x 120/150/180 x 57 cm
Surface board HxB	120 x 120/150/180 cm
Weight	25/30/34 kg

### Materials

Structure	Solid wood (Oak or Ash)
Board	MDF, beschichtet (RAL 9003)

### Shipping details

Volume shipping weight	50/52/58 kg
Packages	3
Shipping method	Freight forwarding

### Options

Width	120 cm , 150 cm, 180 cm
Woods	<input checked="" type="radio"/> <input type="radio"/> <input type="radio"/>
Castor colors	<input checked="" type="radio"/> <input type="radio"/>
Tray (optional)	<input checked="" type="radio"/> <input type="radio"/>

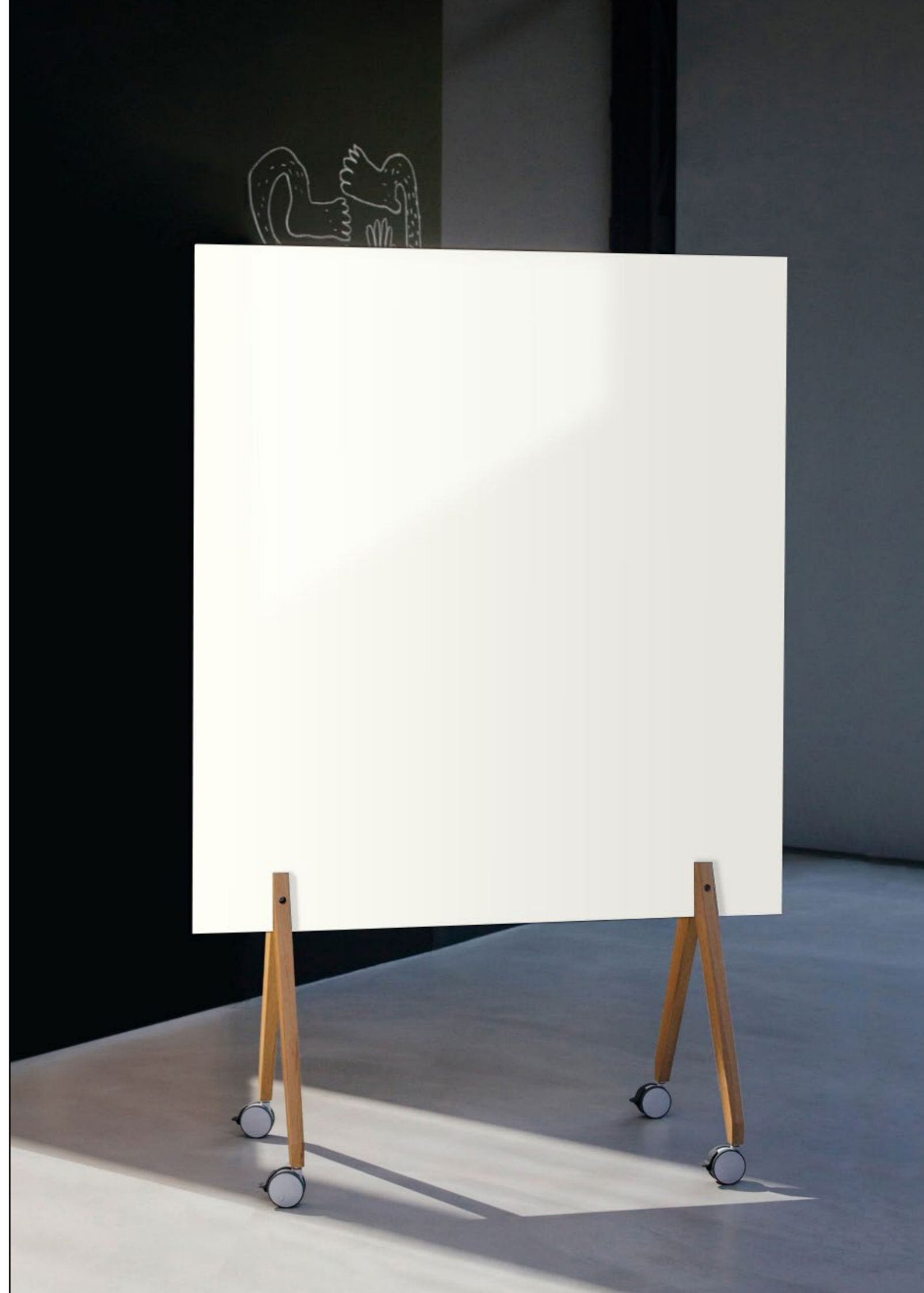
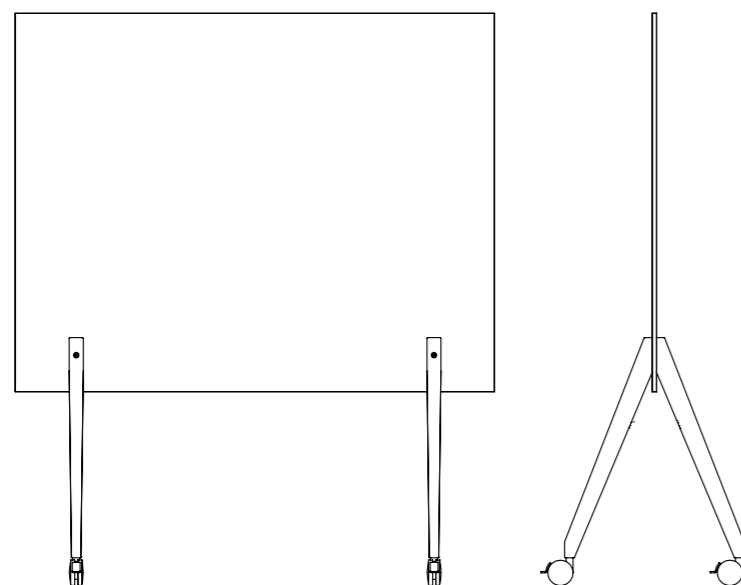

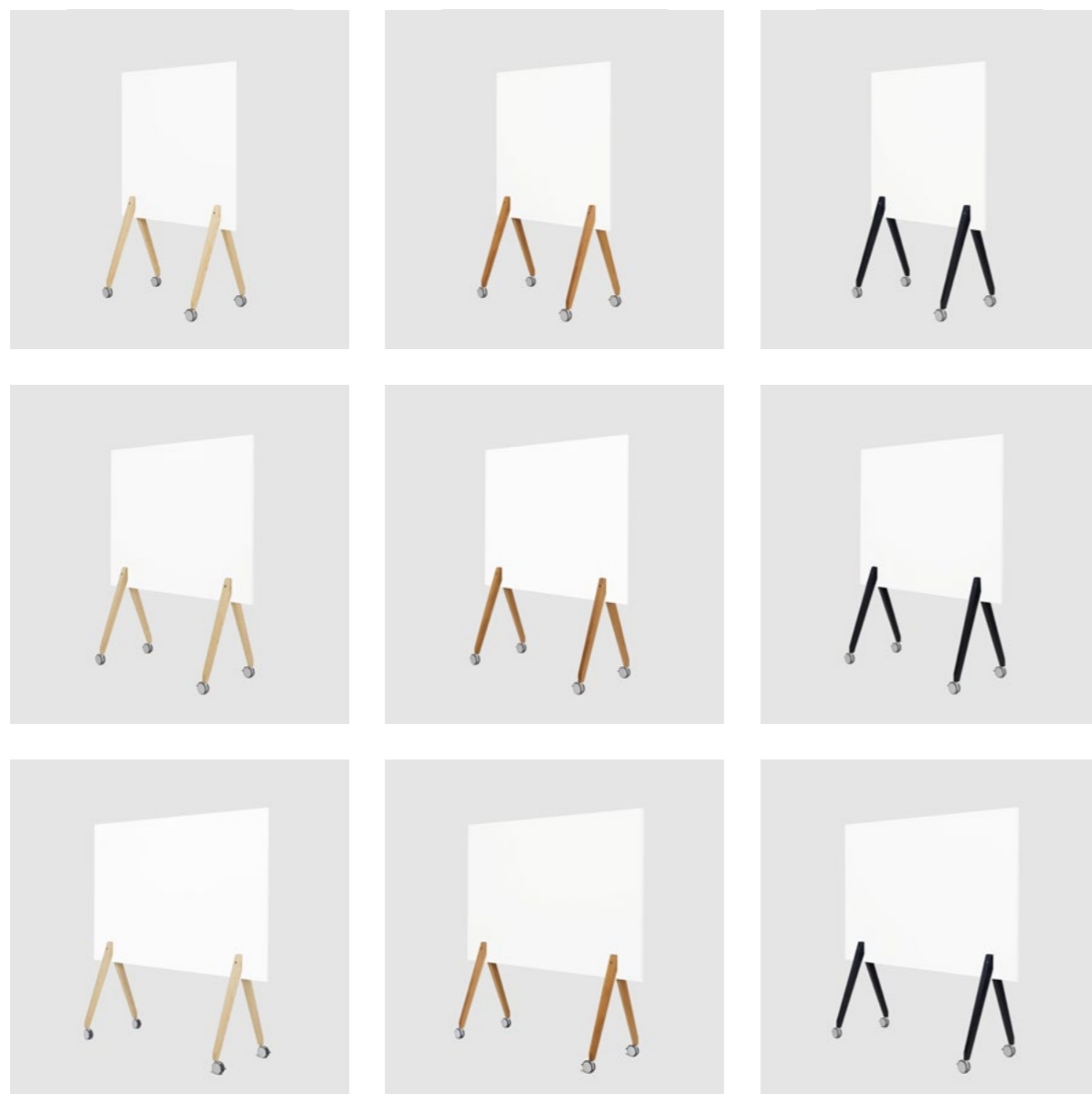

Article number	Width	Wood	Castors
WloT-WT120.A.1	120 cm	Ash	White
WloT-WT120.O.1	120 cm	Oak	White
WloT-WT120.BK.1	120 cm	Ash, stained black	White
WloT-WT150.A.1	150 cm	Ash	White
WloT-WT150.O.1	150 cm	Oak	White
WloT-WT150.BK.1	150 cm	Ash, stained black	White
WloT-WT180.A.1	180 cm	Ash	White
WloT-WT180.O.1	180 cm	Oak	White
WloT-WT180.BK.1	180 cm	Ash, stained black	White

Article number	Width	Wood	Castors
WloT-WT120.A.2	120 cm	Ash	Black
WloT-WT120.O.2	120 cm	Oak	Black
WloT-WT120.BK.2	120 cm	Ash, stained black	Black
WloT-WT150.A.2	150 cm	Ash	Black
WloT-WT150.O.2	150 cm	Oak	Black
WloT-WT150.BK.2	150 cm	Ash, stained black	Black
WloT-WT180.A.2	180 cm	Ash	Black
WloT-WT180.O.2	180 cm	Oak	Black
WloT-WT180.BK.2	180 cm	Ash, stained black	Black

## Pin Up on Tour (Whiteboard)

The board made of powder coated sheet steel has a dry wipe surface and can be written on one side with whiteboard markers - the other side serves as a pin board with pleasant haptic material.

Pin Up on Tour was awarded with the IF Design Award 2017.



### Details

Dimensions HxWxD in cm	180 x 120/150 x 57
Surface board HxB in cm	120 x 120/150
Weight in kg	31/36

### Materials

Structure	Solid wood (Oak or Ash)
Whiteboard	Sheet steel, powder coated (RA L 9016)
Pinboard	Natural felt from merino wool, mottled gray

### Shipping details

Volume shipping weight	50/52 kg
Packages	3
Shipping method	Freight forwarding

### Options

Width	120 cm , 150 cm
Woods	<input type="radio"/> <input type="radio"/> <input type="radio"/>
Castor colors	<input type="radio"/> <input type="radio"/>
Tray (optional)	<input type="radio"/> <input type="radio"/>
Special sizes and colors possible on request	

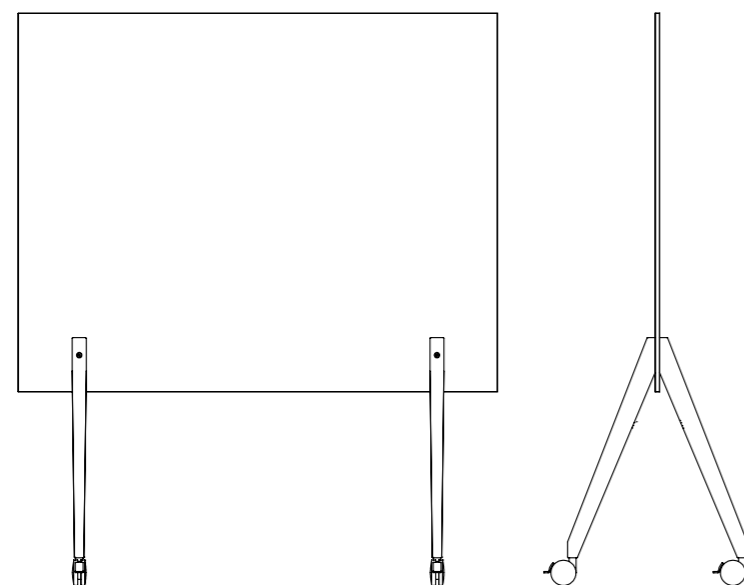

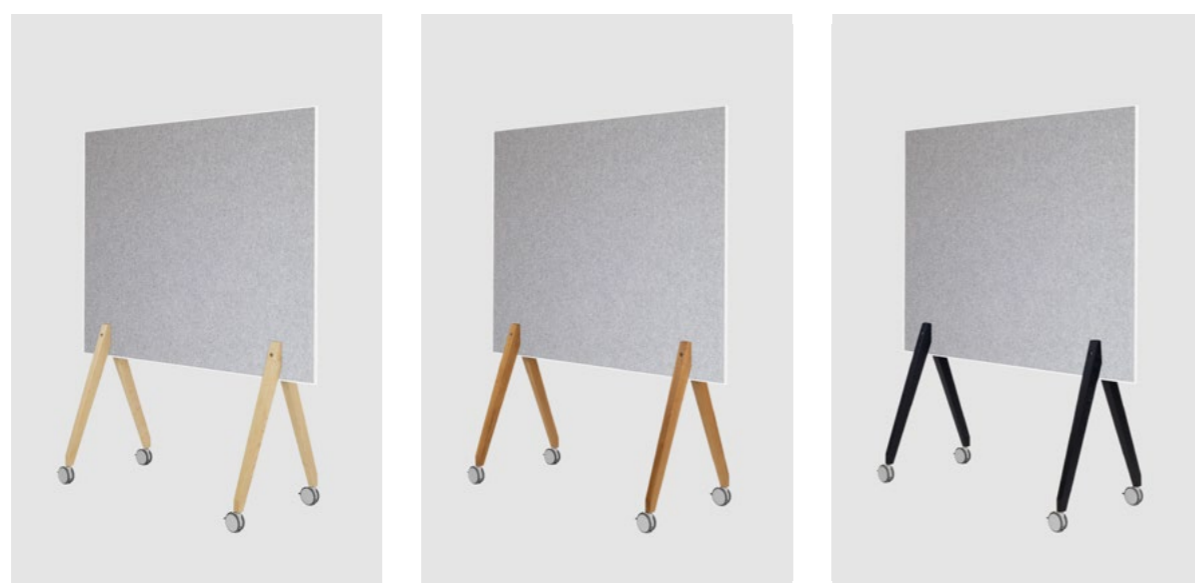
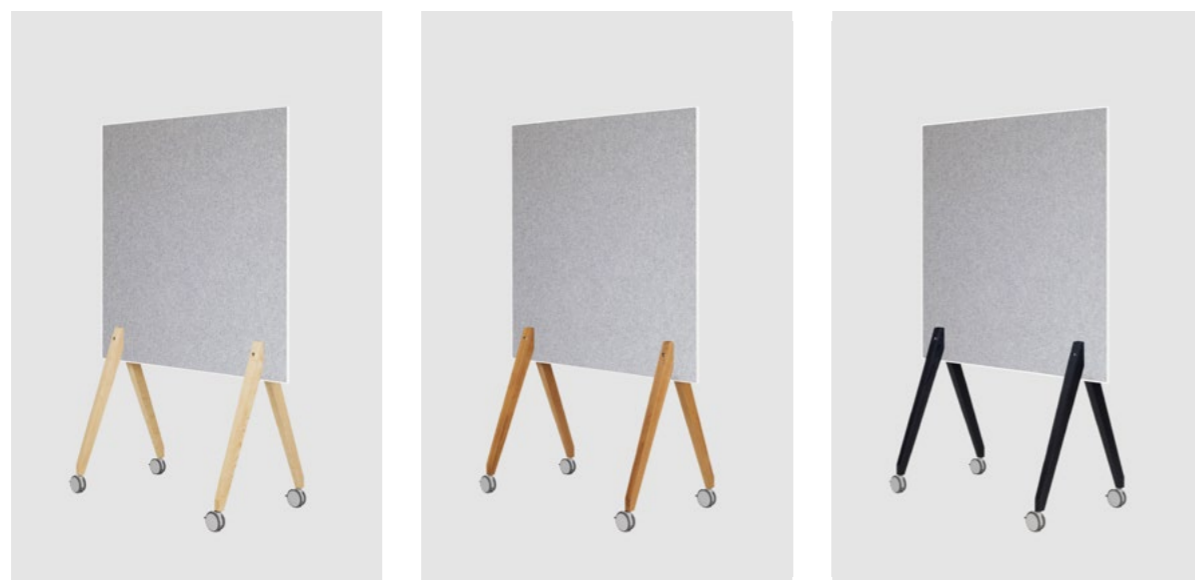

Article number	Width	Wood	Castors
PUoT-WT120.A.1	120 cm	Ash	White
PUoT-WT120.O.1	120 cm	Oak	White
PUoT-WT120.BK.1	120 cm	Ash, stained black	White
PUoT-WT150.A.1	150 cm	Ash	White
PUoT-WT150.O.1	150 cm	Oak	White
PUoT-WT150.BK.1	150 cm	Ash, stained black	White

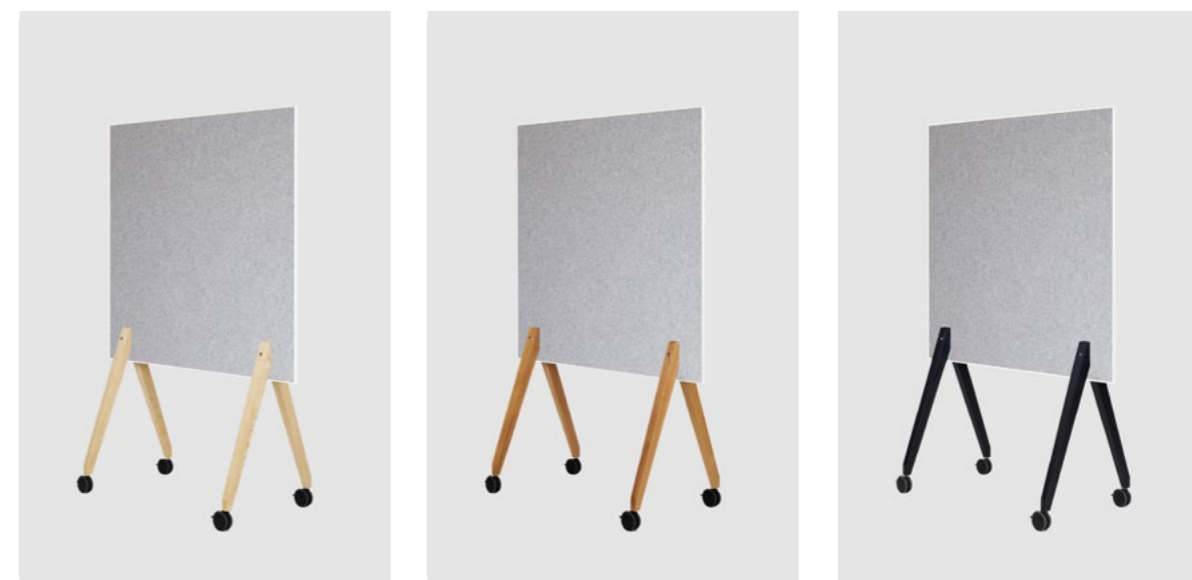

Article number	Width	Wood	Castors
PUoT-WT120.A.2	120 cm	Ash	Black
PUoT-WT120.O.2	120 cm	Oak	Black
PUoT-WT120.BK.2	120 cm	Ash, stained black	Black
PUoT-WT150.A.2	150 cm	Ash	Black
PUoT-WT150.O.2	150 cm	Oak	Black
PUoT-WT150.BK.2	150 cm	Ash, stained black	Black

## Pin Up on Tour (Black magnetic board)

The board made of powder coated sheet steel has a surface that can be used with magnets - the other side serves as a pinboard with pleasantly tactile material.



### Details

Dimensions HxWxD	180 x 120/150 x 57 cm
Surface board HxB	120 x 120/150 cm
Weight	31/36 kg

### Materials

Structure	Solid wood (Oak or Ash)
Board	Sheet steel, powder coated (RAL 9005)
Pinboard	Naturfilz aus Merinowolle

### Shipping details

Volume shipping weight	50/52 kg
Packages	3
Shipping method	Freight forwarding

### Options

Width	120 cm , 150 cm
Woods	<input type="radio"/> <input type="radio"/> <input type="radio"/>
Castor colors	<input type="radio"/> <input type="radio"/>
Tray (optional)	<input type="radio"/> <input type="radio"/>
Special sizes and colors available upon request	

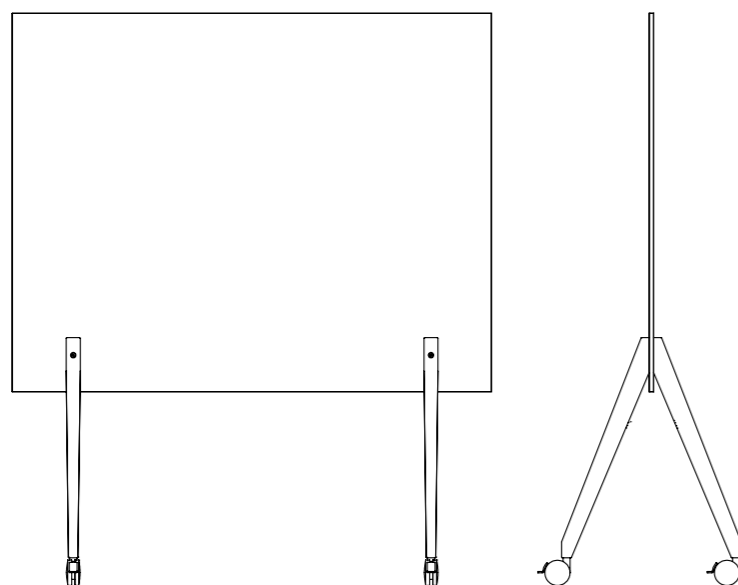

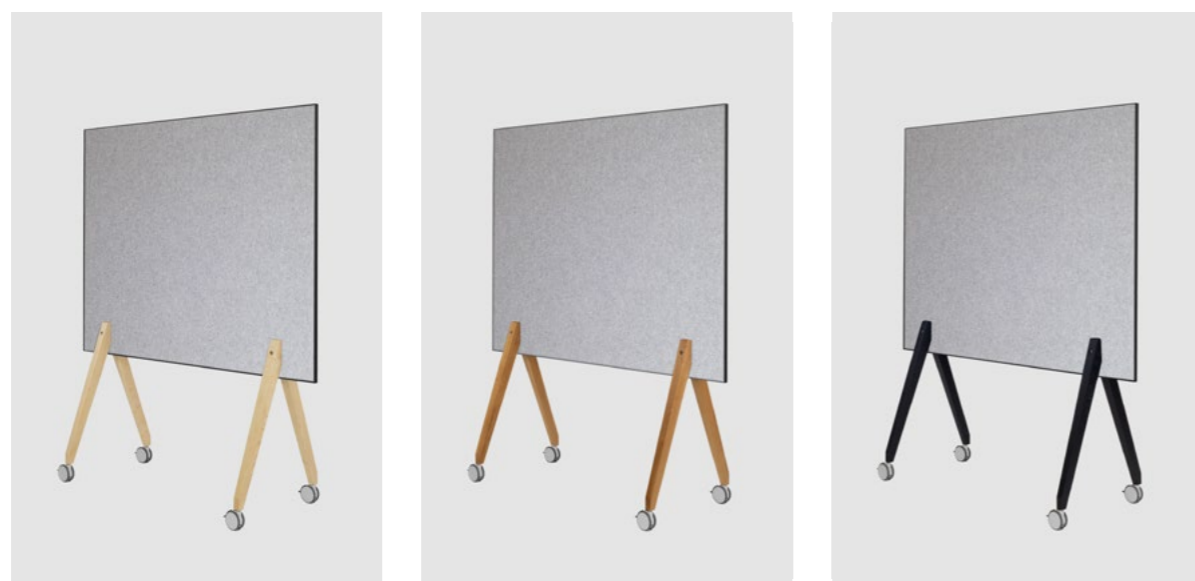
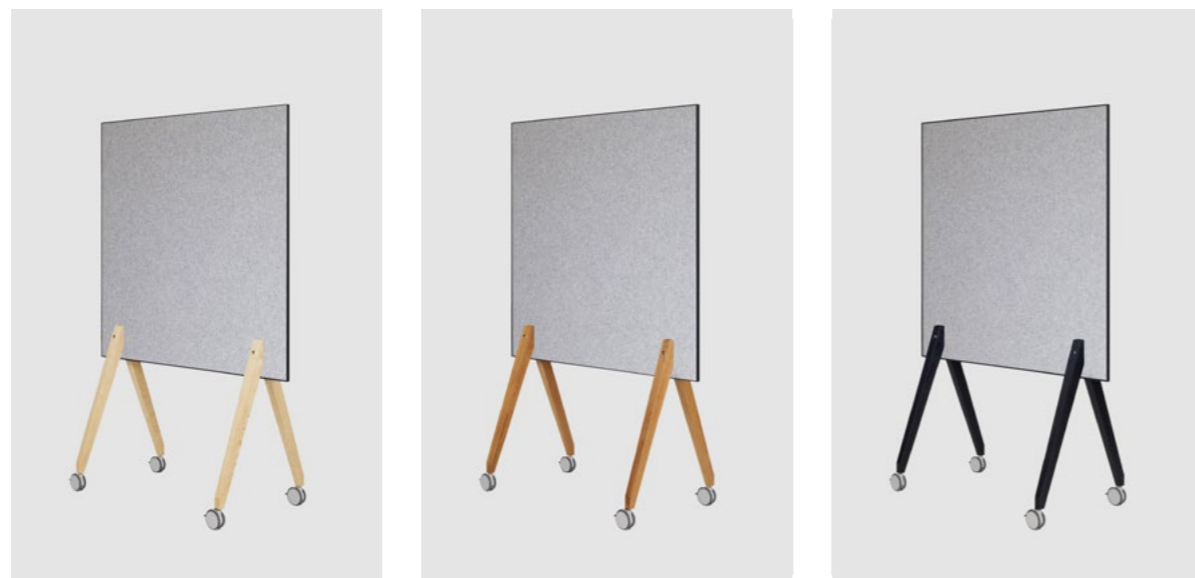

Article number	Width	Wood	Castors
PUoT-BK120.A.1	120 cm	Ash	White
PUoT-BK120.O.1	120 cm	Oak	White
PUoT-BK120.BK.1	120 cm	Ash, stained black	White
PUoT-BK150.A.1	150 cm	Ash	White
PUoT-BK150.O.1	150 cm	Oak	White
PUoT-BK150.BK.1	150 cm	Ash, stained black	White

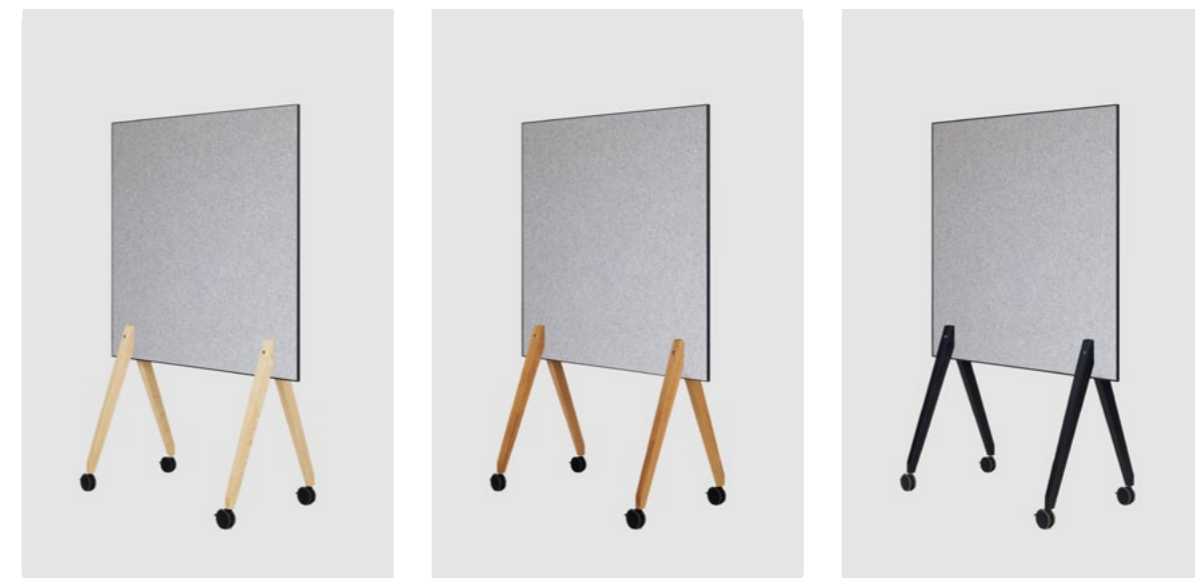

Article number	Width	Wood	Castors
PUoT-BK120.A.2	120 cm	Ash	Black
PUoT-BK120.O.2	120 cm	Oak	Black
PUoT-BK120.BK.2	120 cm	Ash, stained black	Black
PUoT-BK150.A.2	150 cm	Ash	Black
PUoT-BK150.O.2	150 cm	Oak	Black
PUoT-BK150.BK.2	150 cm	Ash, stained black	Black



## Glassworks

The frameless glass boards are open to new ideas. 6 mm strong elegance meets pure function: the softly tinted, transparent ESG safety glass is writable and easy to clean, the wood legs on castors make the board mobile. Width flexible. Thanks to their transparency, the glassboards are also suitable for small width of course for all those who always want to have a clear view.

### Details

Dimensions H x W x D	180 x 120/150 x 57 cm
Surface board H x W	120 x 120/150 cm
Weight	25/30 kg





### Materials

Structure	Solid wood (Oak or Ash)
Board	ESG-safety glass, tinted

### Shipping details

Volume shipping weight	50 /52 kg
Packages	3
Shipping method	Freight forwarding

### Options

Width	120 cm , 150 cm
Glass color	
Woods	
Castor colors	
Tray (optional)	

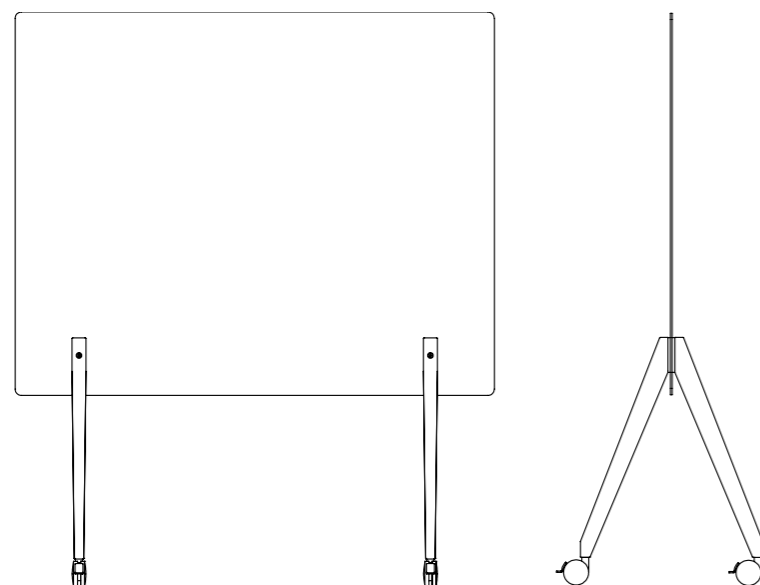

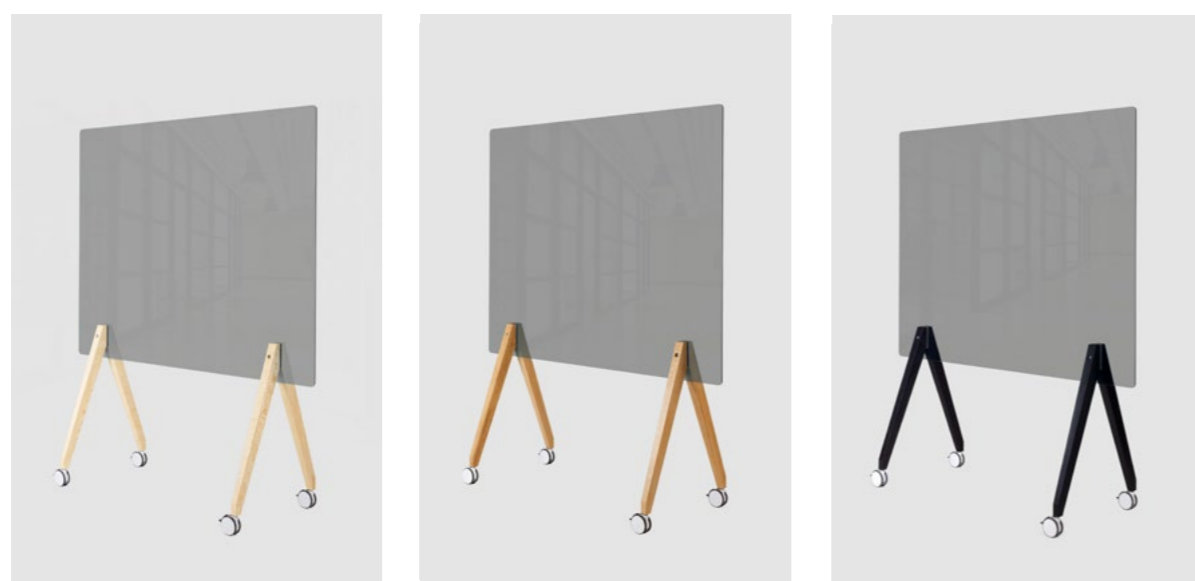
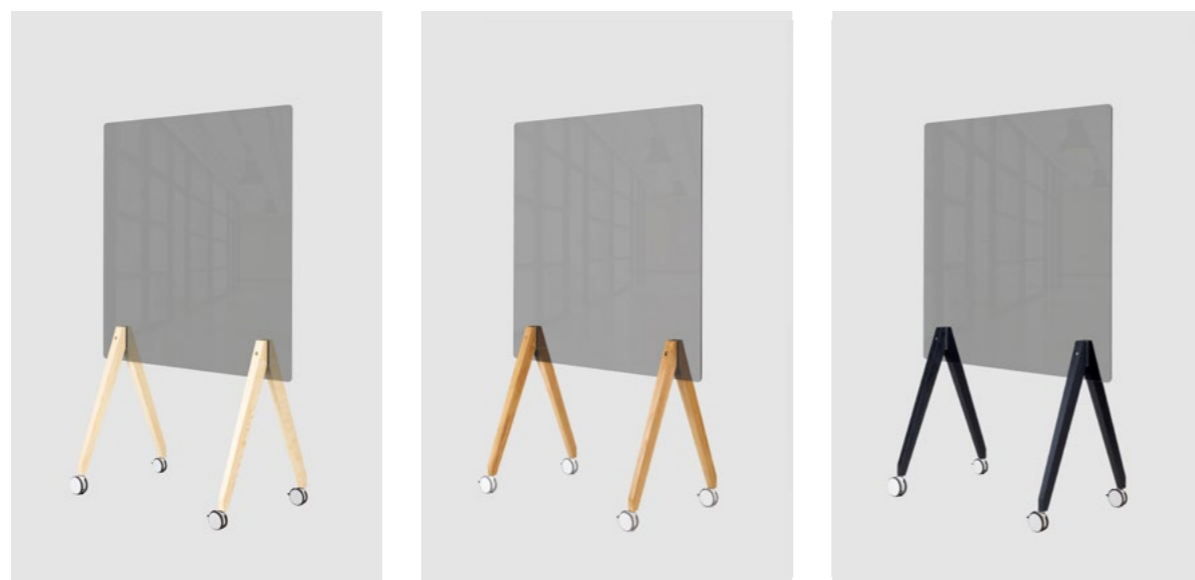

Article number	Width	Colour	Wood	Castors
GW-GR120.A.1	120 cm	Grey	Ash	White
GW-GR120.O.1	120 cm	Grey	Oak	White
GW-GR120.BK.1	120 cm	Grey	Ash, stained black	White
GW-GR150.A.1	150 cm	Grey	Ash	White
GW-GR150.O.1	150 cm	Grey	Oak	White
GW-GR150.BK.1	150 cm	Grey	Ash, stained black	White

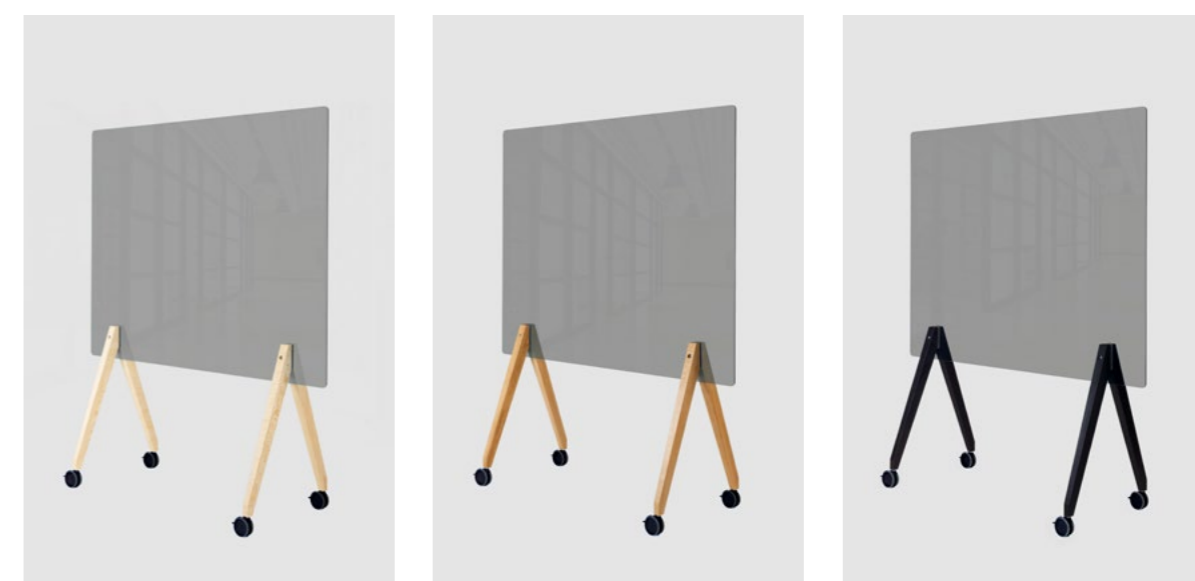
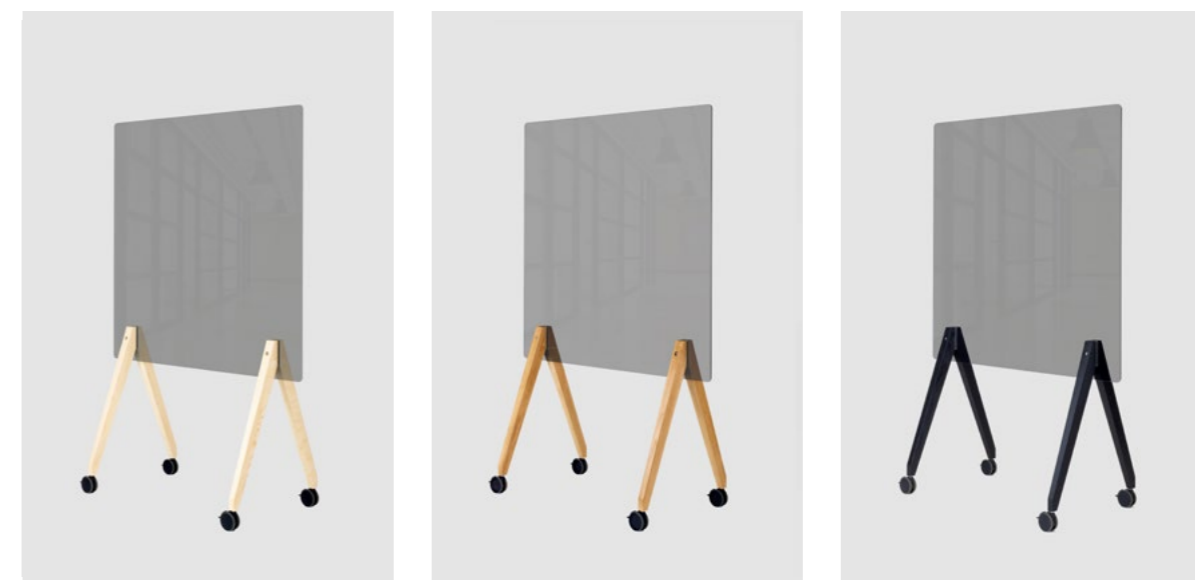

Article number	Width	Colour	Wood	Castors
GW-GR120.A.2	120 cm	Grey	Ash	Black
GW-GR120.O.2	120 cm	Grey	Oak	Black
GW-GR120.BK.2	120 cm	Grey	Ash, stained black	Black
GW-GR150.A.2	150 cm	Grey	Ash	Black
GW-GR150.O.2	150 cm	Grey	Oak	Black
GW-GR150.BK.2	150 cm	Grey	Ash, stained black	Black

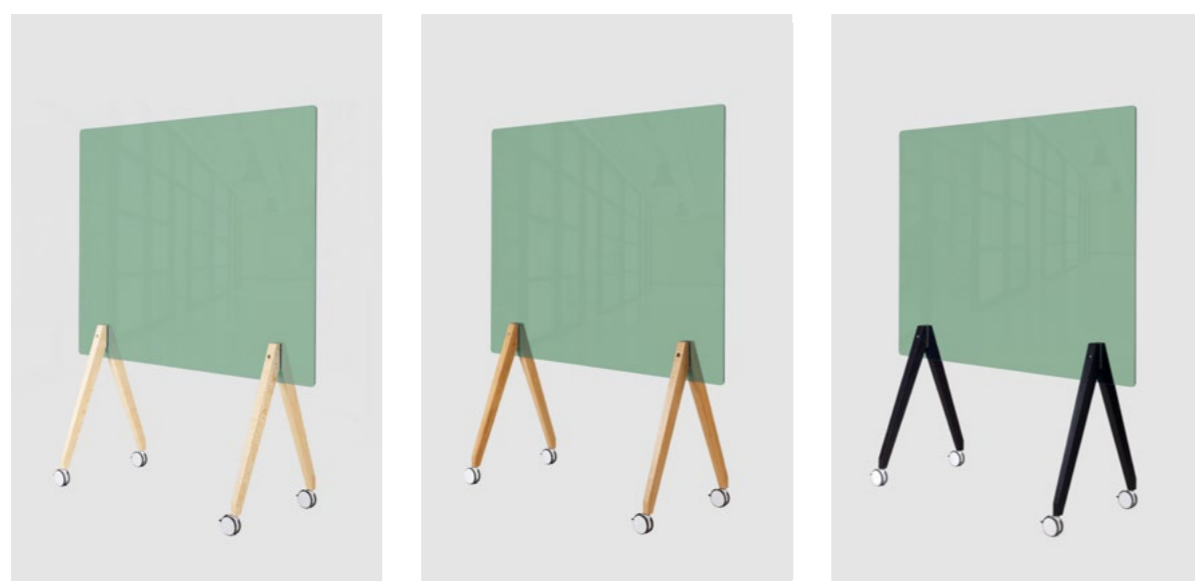
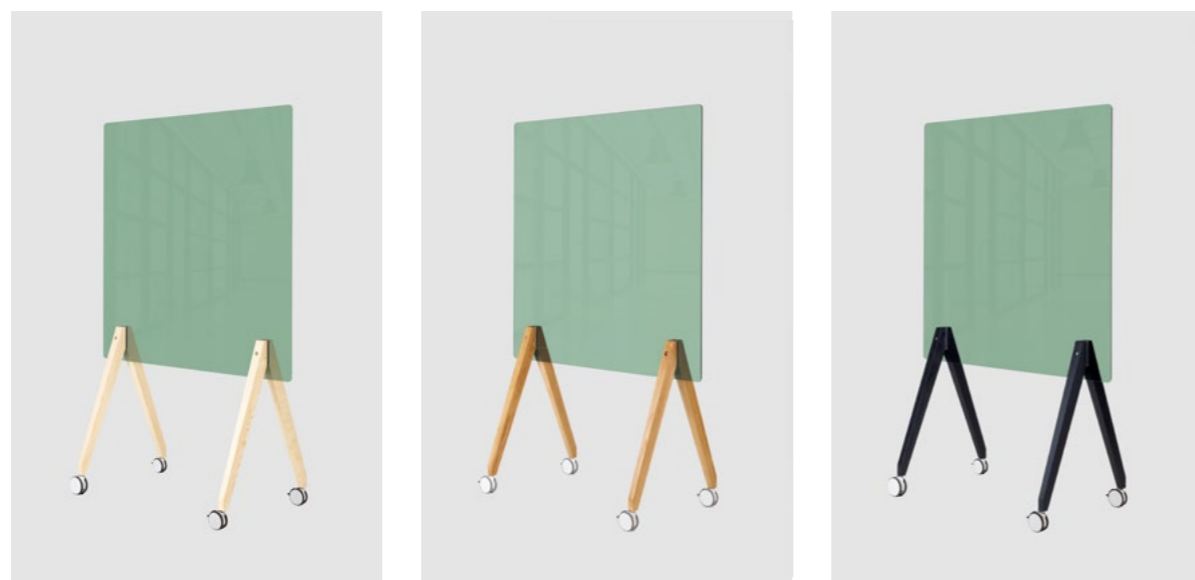

Article number	Width	Colour	Wood	Castors
GW-GN120.A.1	120 cm	Green	Ash	White
GW-GN120.O.1	120 cm	Green	Oak	White
GW-GN120.BK.1	120 cm	Green	Ash, stained black	White
GW-GN150.A.1	150 cm	Green	Ash	White
GW-GN150.O.1	150 cm	Green	Oak	White
GW-GN150.BK.1	150 cm	Green	Ash, stained black	White

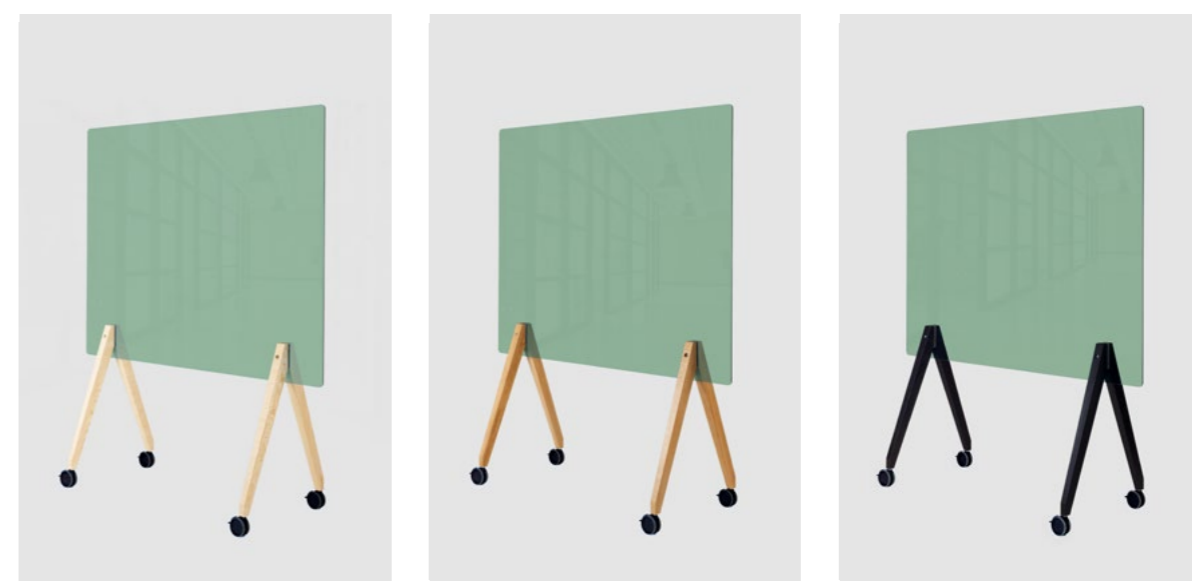
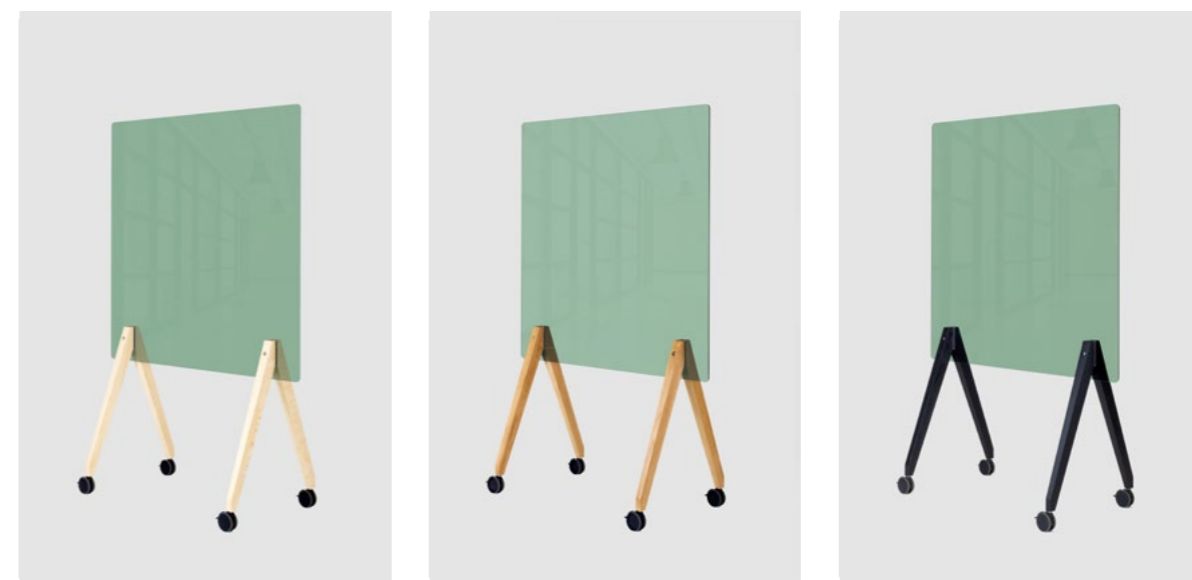

Article number	Width	Colour	Wood	Castors
GW-GN120.A.2	120 cm	Green	Ash	Black
GW-GN120.O.2	120 cm	Green	Oak	Black
GW-GN120.BK.2	120 cm	Green	Ash, stained black	Black
GW-GN150.A.2	150 cm	Green	Ash	Black
GW-GN150.O.2	150 cm	Green	Oak	Black
GW-GN150.BK.2	150 cm	Green	Ash, stained black	Black

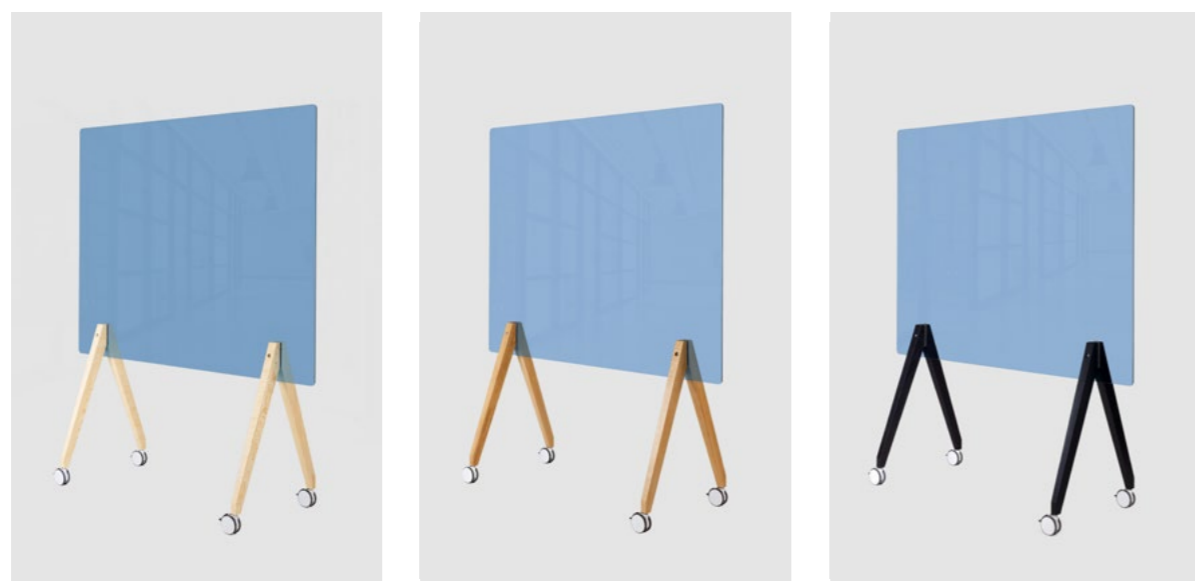
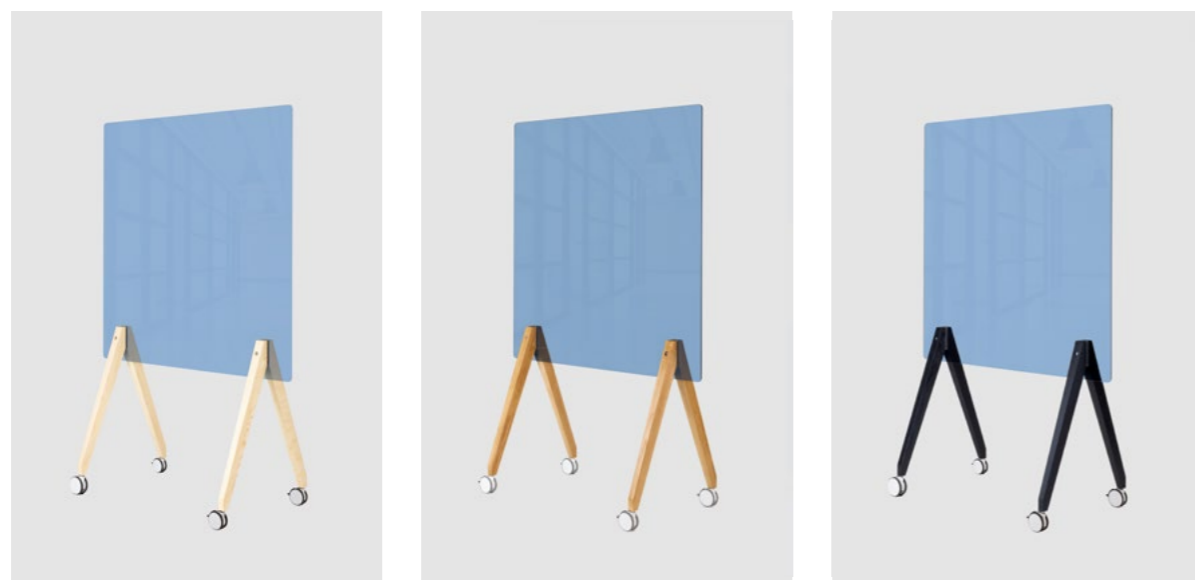

Article number	Width	Colour	Wood	Castors
GW-BL120.A.1	120 cm	Blue	Ash	White
GW-BL120.O.1	120 cm	Blue	Oak	White
GW-BL120.BK.1	120 cm	Blue	Ash, stained black	White
GW-BL150.A.1	150 cm	Blue	Ash	White
GW-BL150.O.1	150 cm	Blue	Oak	White
GW-BL150.BK.1	150 cm	Blue	Ash, stained black	White

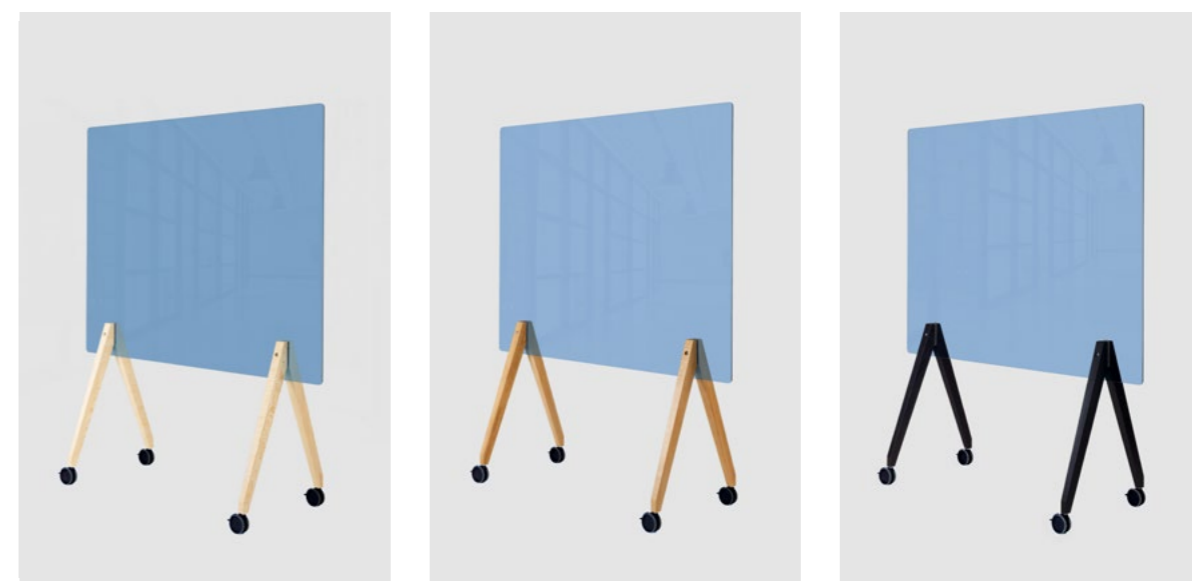
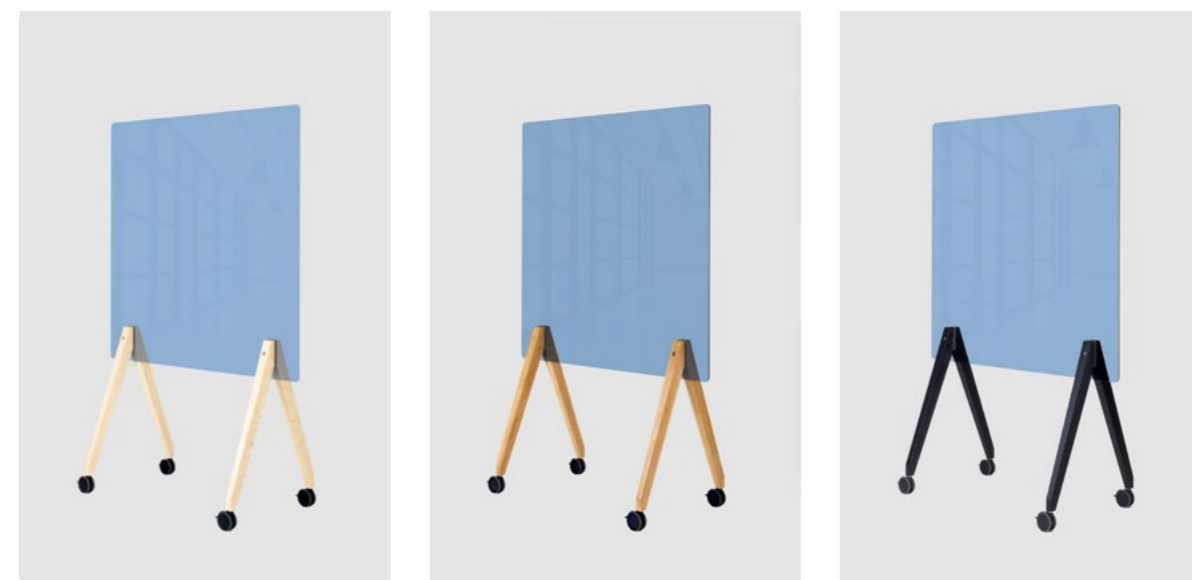

Article number	Width	Colour	Wood	Castors
GW-BL120.A.2	120 cm	Blue	Ash	Black
GW-BL120.O.2	120 cm	Blue	Oak	Black
GW-BL120.BK.2	120 cm	Blue	Ash, stained black	Black
GW-BL150.A.2	150 cm	Blue	Ash	Black
GW-BL150.O.2	150 cm	Blue	Oak	Black
GW-BL150.BK.2	150 cm	Blue	Ash, stained black	Black

## Chalk Talk

To write on with chalk or chalk marker, the classic blackboard on four wooden legs is a very familiar tool and at the same time wonderfully mobile and quickly moved away if memories do become too intense. The boards from roomours are clear in design and functional in use with their damp wipe and magnetic surfaces.



### Details

Dimensions H x W x D	180 x 120/150/180 x 57 cm
Surface board H x W	120 x 120/150/180 cm
Weight	25/30/34 kg

### Materials

Structure	Solid wood (Oak or Ash)
Board	MDF board, magnetic coated

### Shipping details

Volume shipping weight	50/52/58 kg
Packages	3
Shipping method	Freight forwarding

### Options

Width	120 cm , 150 cm, 180 cm
Colour Board	<input checked="" type="radio"/> <input checked="" type="radio"/>
Woods	<input checked="" type="radio"/> <input checked="" type="radio"/> <input checked="" type="radio"/>
Castor colors	<input checked="" type="radio"/> <input type="radio"/>
Tray (optional)	<input checked="" type="radio"/> <input type="radio"/>

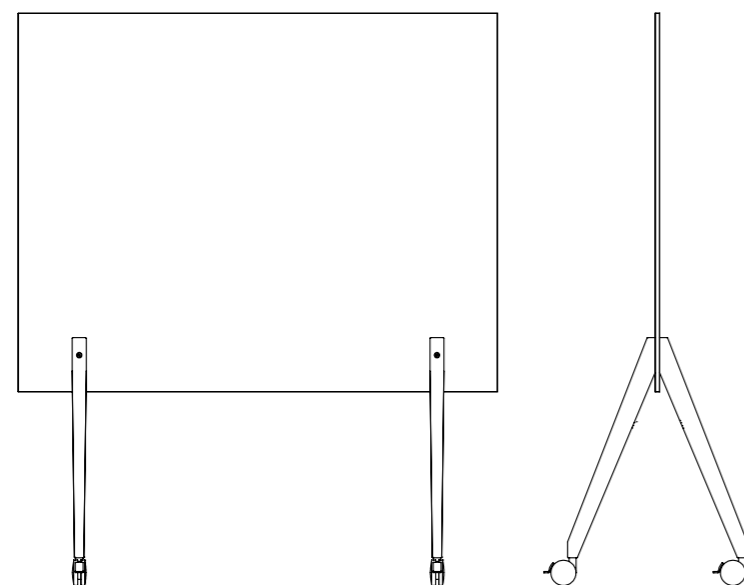



Article number	Width	Colour	Wood	Castors
WIoT-GN120.A.1	120 cm	Green similar RAL 6028	Ash	White
WIoT-GN120.O.1	120 cm	Green similar RAL 6028	Oak	White
WIoT-GN120.BK.1	120 cm	Green similar RAL 6028	Ash, stained black	White
WIoT-GN150.A.1	150 cm	Green similar RAL 6028	Ash	White
WIoT-GN150.O.1	150 cm	Green similar RAL 6028	Oak	White
WIoT-GN150.BK.1	150 cm	Green similar RAL 6028	Ash, stained black	White
WIoT-GN180.A.1	180 cm	Green similar RAL 6028	Ash	White
WIoT-GN180.O.1	180 cm	Green similar RAL 6028	Oak	White
WIoT-GN180.BK.1	180 cm	Green similar RAL 6028	Ash, stained black	White

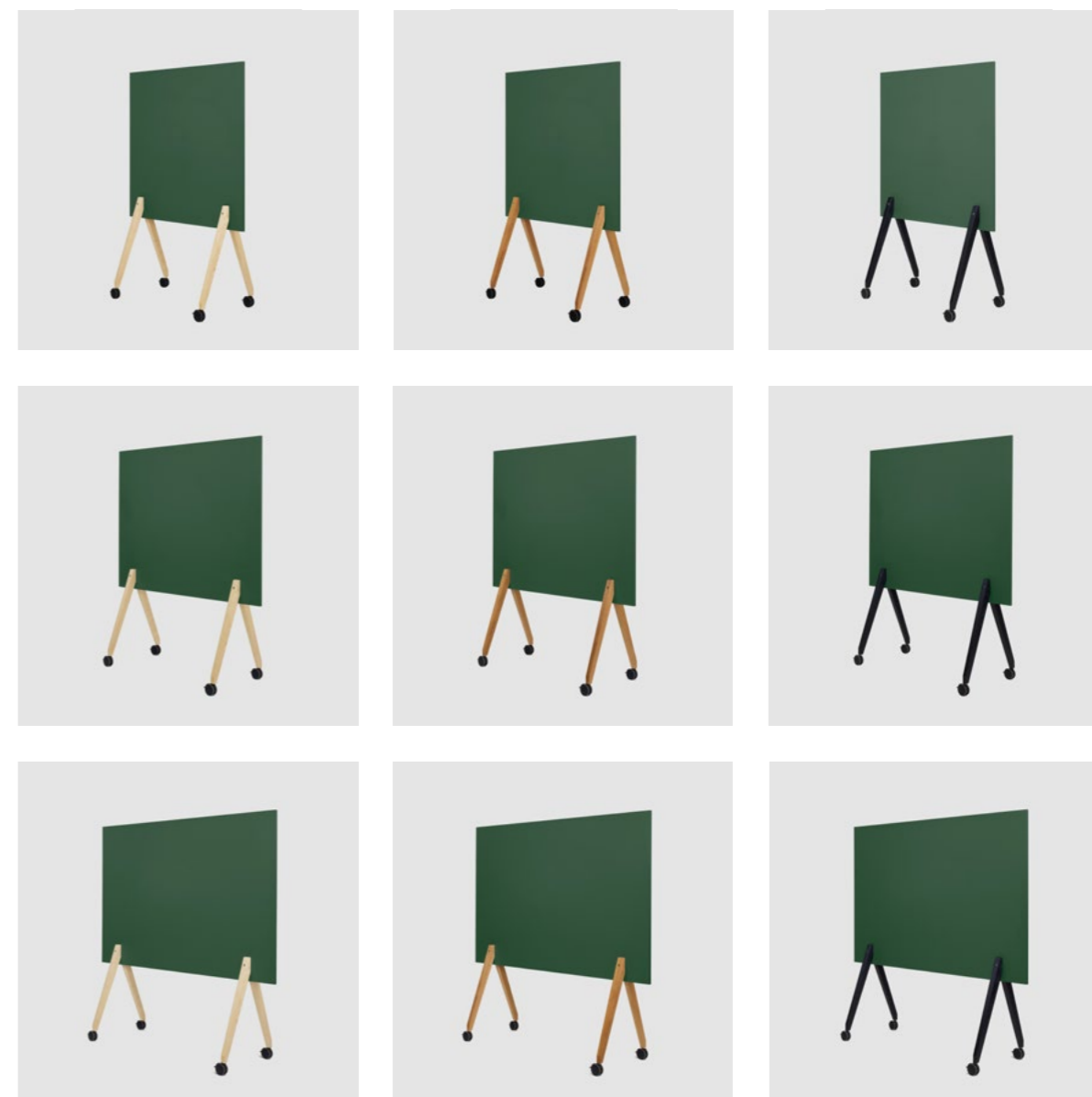

Article number	Width	Colour	Wood	Castors
WIoT-GN120.A.2	120 cm	Green similar RAL 6028	Ash	Black
WIoT-GN120.O.2	120 cm	Green similar RAL 6028	Oak	Black
WIoT-GN120.BK.2	120 cm	Green similar RAL 6028	Ash, stained black	Black
WIoT-GN150.A.2	150 cm	Green similar RAL 6028	Ash	Black
WIoT-GN150.O.2	150 cm	Green similar RAL 6028	Oak	Black
WIoT-GN150.BK.2	150 cm	Green similar RAL 6028	Ash, stained black	Black
WIoT-GN180.A.2	180 cm	Green similar RAL 6028	Ash	Black
WIoT-GN180.O.2	180 cm	Green similar RAL 6028	Oak	Black
WIoT-GN180.BK.2	180 cm	Green similar RAL 6028	Ash, stained black	Black



Article number	Width	Colour	Wood	Castors
WIoT-BK120.A.1	120 cm	Black similar RAL 7021	Ash	White
WIoT-BK120.O.1	120 cm	Black similar RAL 7021	Oak	White
WIoT-BK120.BK.1	120 cm	Black similar RAL 7021	Ash, stained black	White
WIoT-BK150.A.1	150 cm	Black similar RAL 7021	Ash	White
WIoT-BK150.O.1	150 cm	Black similar RAL 7021	Oak	White
WIoT-BK150.BK.1	150 cm	Black similar RAL 7021	Ash, stained black	White
WIoT-BK180.A.1	180 cm	Black similar RAL 7021	Ash	White
WIoT-BK180.O.1	180 cm	Black similar RAL 7021	Oak	White
WIoT-BK180.BK.1	180 cm	Black similar RAL 7021	Ash, stained black	White

Article number	Width	Colour	Wood	Castors
WIoT-BK120.A.2	120 cm	Black similar RAL 7021	Ash	Black
WIoT-BK120.O.2	120 cm	Black similar RAL 7021	Oak	Black
WIoT-BK120.BK.2	120 cm	Black similar RAL 7021	Ash, stained black	Black
WIoT-BK150.A.2	150 cm	Black similar RAL 7021	Ash	Black
WIoT-BK150.O.2	150 cm	Black similar RAL 7021	Oak	Black
WIoT-BK150.BK.2	150 cm	Black similar RAL 7021	Ash, stained black	Black
WIoT-BK180.A.2	180 cm	Black similar RAL 7021	Ash	Black
WIoT-BK180.O.2	180 cm	Black similar RAL 7021	Oak	Black
WIoT-BK180.BK.2	180 cm	Black similar RAL 7021	Ash, stained black	Black

## Shelf for Boards - Tray

Tray is the ideal complement to our boards and can be easily attached between the brackets - creating a practical storage space for pens, magnets, pins Width everything necessary for creative work.

### Details

Dimensions H x W x D	6 x 92/112/137 x 16,5 cm
Suitable for	Chalk Talk, Glassworks, Pin Up on Tour, Write It on Tour
Material	Sheet steel, powder coated

### Shipping details

Volume shipping weight	8/10/12 kg
Packages	1
Shipping method	Freight forwarding

### Options

Width	120 cm , 150 cm, 180 cm
Colour	<input checked="" type="radio"/> <input type="radio"/>

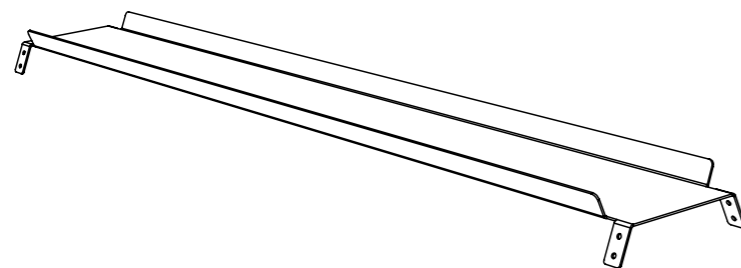





Shelf for Boards - Tray // 81

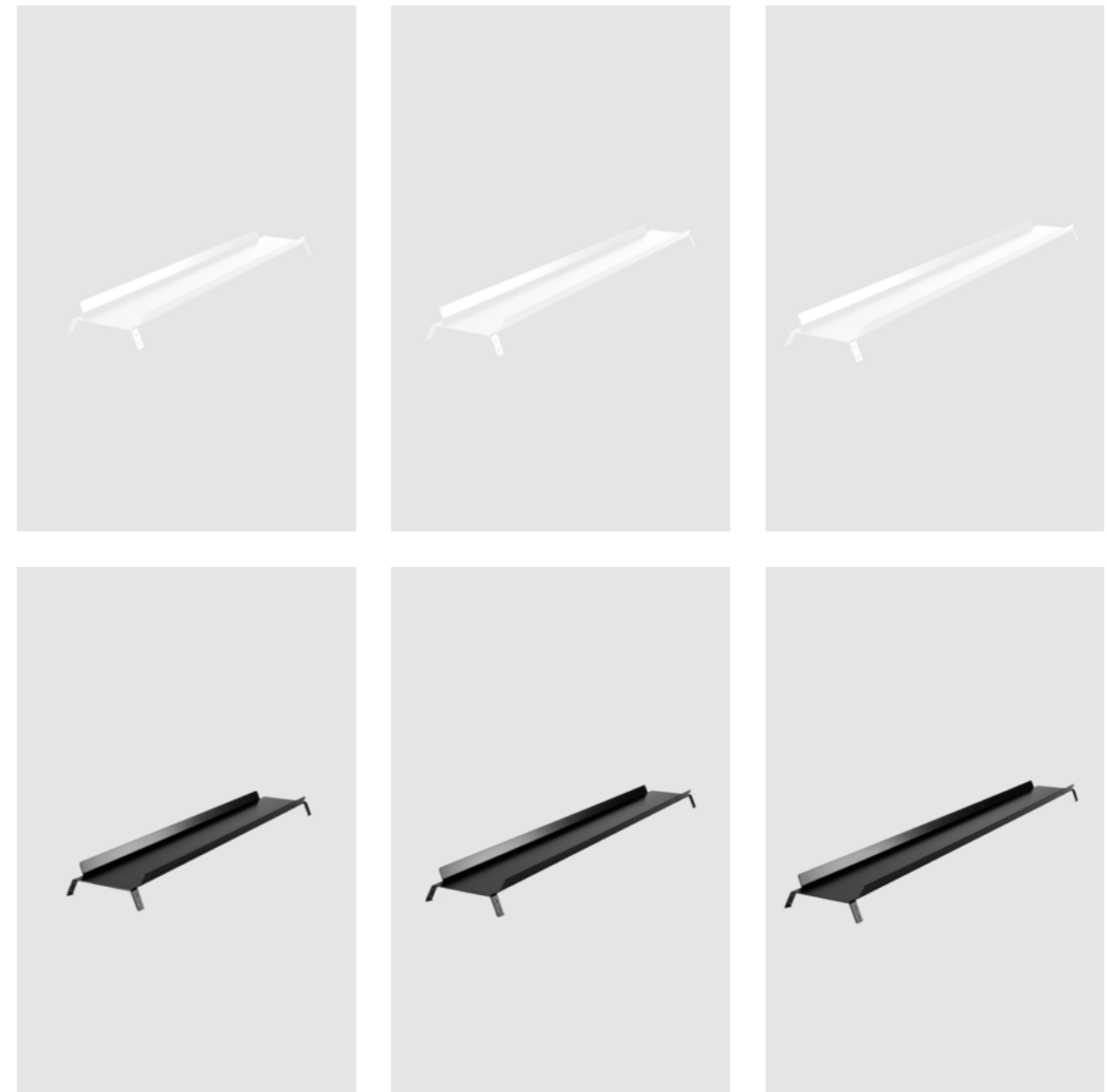

Article number	Width	Colour	
SF-WT120	120 cm	Traffic white RAL 9016	○
SF-WT150	150 cm	Traffic white RAL 9016	○
SF-WT180	180 cm	Traffic white RAL 9016	○
SF-BK120	120 cm	Jet black RAL 9005	●
SF-BK150	150 cm	Jet black RAL 9005	●
SF-BK180	180 cm	Jet black RAL 9005	●

## Pen tray Keep It

With Keep It everything has its place - the tray keeps pen Width sponge always handy for the next use. Simple Width clear in its form, the practical tray is the perfect add-on for all our mobile boards.

### Details

Dimensions H x W x D	14 x 24 x 9 cm
Suitable for	Chalk Talk, Glassworks, Pin Up on Tour, Write It on Tour
Material	Sheet steel, powder coated

### Shipping details

Volume shipping weight	2 kg
Packages	1
Shipping method	Paket

### Options

Colours	
---------	---

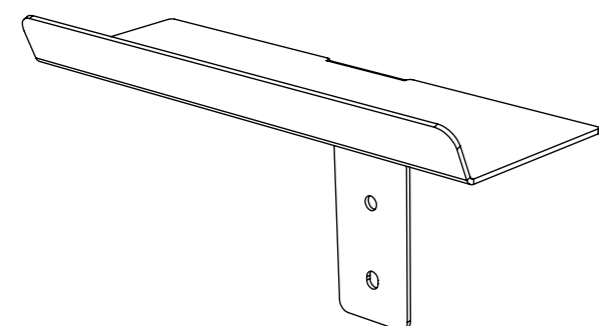

Article number	Colour	
KI-WT	Traffic white RAL 9016	<input type="radio"/>
KI-BK	Jet black RAL 9016	<input type="radio"/>
KI-ED	Traffic red RAL 3020	<input type="radio"/>
KI-GN	Yellow green RAL 6018	<input type="radio"/>
KI-GR	Stone grey RAL 7030	<input type="radio"/>
KI-YE	Zinc yellow RAL 1018	<input type="radio"/>

## Flipchart holder Hold On

Hold On is the logical addition for our boards. Simple and functional - whether whiteboard, blackboard or pinboard: with Hold On you can hang our flipchart pads on your board and give free rein to your creativity.

### Details

Dimensions H x W x D	8 x 70 x 3 cm
Lochabstand	50 cm
Passt zu	Chalk Talk, Pin Up on Tour, Write It on Tour
Weight	2 kg

### Materials

Metall	powder coated Metall
Inlay	PolyesterFleece
Tear bar	Polycarbonat, transparent

### Shipping details

Volume shipping weight	3 kg
Packages	1
Shipping method	Paket

### Options

Colour



### Article number

HO-WT

HO-BK

### Colour

Traffic white RAL 9016

Jet black RAL 9005



## Post and Pin

Post and Pin makes agile work possible in a wide variety of forms. The tool serves with its receptacle for different materials as a perfect base for working with changing media - whether their own or the elements of roomours made of cardboard, foam, fleece or light-weight materials - filled they can be presented on our rail leaning against the wall.



### Details

Dimensions H x W x D	180 x 150 x 57 cm
Surface board H x W	120 x 150 cm
Weight	22 kg

### Materials

Structure	Solid wood (Oak)
Board	Polyester fleece or Gatorfoam
Basis	Sheet steel, powder coated

### Shipping details

Volume shipping weight	50 kg
Packages	4
Shipping method	Freight forwarding

### Options

Board	Fleece, Gatorfoam
Castor colors	<input checked="" type="radio"/> <input type="radio"/>

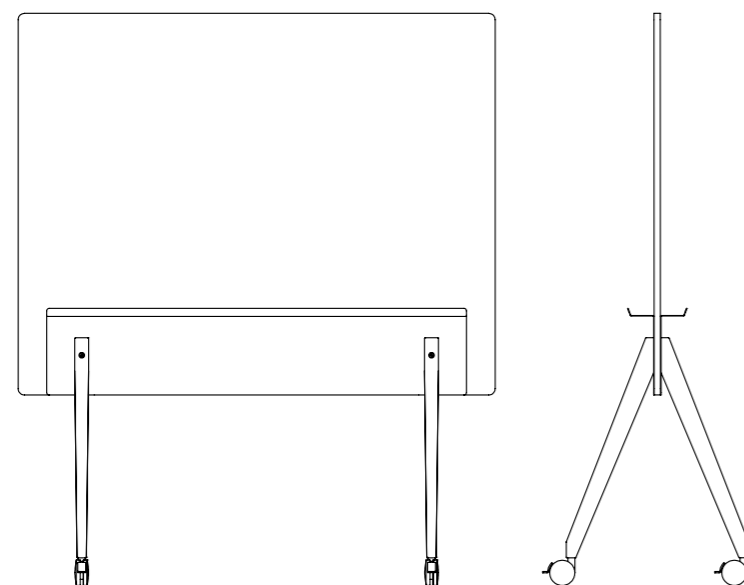

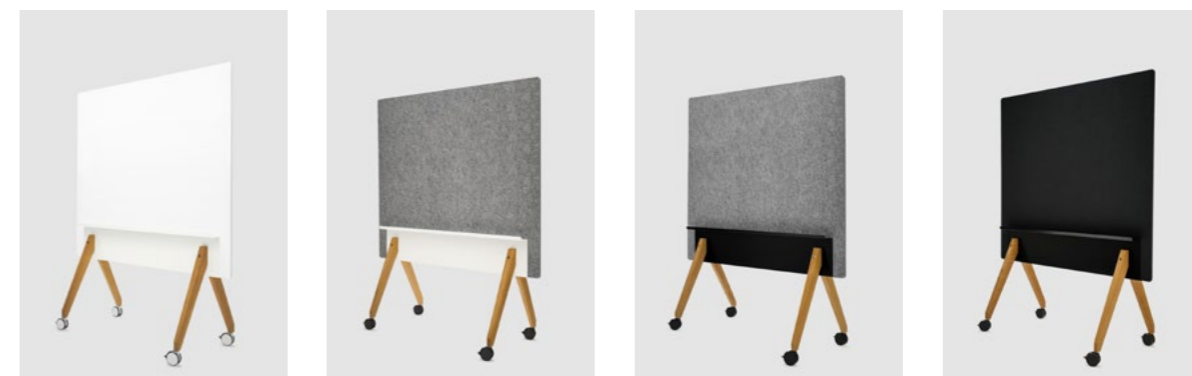

Article Number	Wood	Board	Colour	Castors
PaP-WT.GF-WT.O.1	Oak	Light Foam, white	Traffic White RAL 9016	White
PaP-WT.GF-WT.O.2	Oak	Light Foam, white	Traffic White RAL 9016	Black
PaP-BK.GF-BK.O.1	Oak	Light Foam, black	Jet Black RAL 9005	White
PaP-BK.GF-BK.O.2	Oak	Light Foam, black	Jet Black RAL 9005	Black
PaP-WT.F-GR.O.1	Oak	Fleece, grey	Traffic White RAL 9016	White
PaP-WT.F-GR.O.2	Oak	Fleece, grey	Traffic White RAL 9016	Black
PaP-BK.F-GR.O.1	Oak	Fleece, grey	Jet Black RAL 9005	White
PaP-BK.F-GR.O.2	Oak	Fleece, grey	Jet Black RAL 9005	Black
PaP-WT.F-BK.O.1	Oak	Fleece, black	Traffic White RAL 9016	White
PaP-WT.F-BK.O.2	Oak	Fleece, black	Traffic White RAL 9016	Black
PaP-BK.F-BK.O.1	Oak	Fleece, black	Jet Black RAL 9005	White
PaP-BK.F-BK.O.2	Oak	Fleece, black	Jet Black RAL 9005	Black
PaP-WT.GF-WT.A.1	Ash	Light Foam, white	Traffic White RAL 9016	White
PaP-WT.GF-WT.A.2	Ash	Light Foam, white	Traffic White RAL 9016	Black
PaP-BK.GF-BK.A.1	Ash	Light Foam, black	Jet Black RAL 9005	White
PaP-BK.GF-BK.A.2	Ash	Light Foam, black	Jet Black RAL 9005	Black
PaP-WT.F-GR.A.1	Ash	Fleece, grey	Traffic White RAL 9016	White
PaP-WT.F-GR.A.2	Ash	Fleece, grey	Traffic White RAL 9016	Black
PaP-BK.F-F-GR.A.1	Ash	Fleece, grey	Jet Black RAL 9005	White
PaP-BK.F-F-GR.A.2	Ash	Fleece, grey	Jet Black RAL 9005	Black
PaP-WT.F-BK.A.1	Ash	Fleece, black	Traffic White RAL 9016	White
PaP-WT.F-BK.A.2	Ash	Fleece, black	Traffic White RAL 9016	Black
PaP-BK.F-F-BK.A.1	Ash	Fleece, black	Jet Black RAL 9005	White
PaP-BK.F-F-BK.A.2	Ash	Fleece, black	Jet Black RAL 9005	Black
PaP-WT.GF-WT.BK.1	Black*	Light Foam, white	Traffic White RAL 9016	White
PaP-WT.GF-WT.BK.2	Black*	Light Foam, white	Traffic White RAL 9016	Black
PaP-BK.GF-BK.BK.1	Black*	Light Foam, black	Jet Black RAL 9005	White
PaP-BK.GF-BK.BK.2	Black*	Light Foam, black	Jet Black RAL 9005	Black
PaP-WT.F-GR.BK.1	Black*	Fleece, grey	Traffic White RAL 9016	White
PaP-WT.F-GR.BK.2	Black*	Fleece, grey	Traffic White RAL 9016	Black
PaP-BK.F-GR.BK.1	Black*	Fleece, grey	Jet Black RAL 9005	White
PaP-BK.F-GR.BK.2	Black*	Fleece, grey	Jet Black RAL 9005	Black
PaP-WT.F-BK.BK.1	Black*	Fleece, black	Traffic White RAL 9016	White
PaP-WT.F-BK.BK.2	Black*	Fleece, black	Traffic White RAL 9016	Black
PaP-BK.F-BK.BK.1	Black*	Fleece, black	Jet Black RAL 9005	White
PaP-BK.F-BK.BK.2	Black*	Fleece, black	Jet Black RAL 9005	Black

\* Ash, stained

## Accessories Post and Pin

Post and Pin responds to any change. Mobile, lightweight and adaptable. Is one board not enough for the collected ideas? - an additional second or third board creates even more space. Thanks to the innovative clamp fitting of the base element, the Post and Pin boards can be quickly exchanged, edited and replaced. The boards filled with ideas can be conveniently positioned and presented on the matching wall rails.

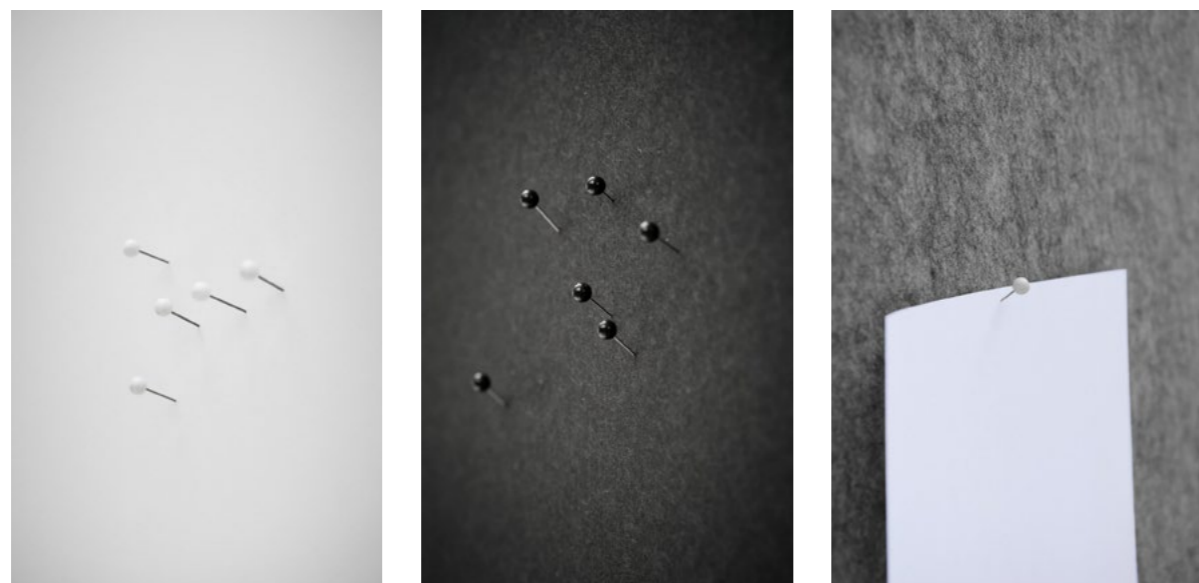

Article number	Name	Material	Colour
PaP-GF-WT	Board	Light foam	White
PaP-GF-BK	Board	Light foam	Black
PaP-F-GR	Board	Fleece	Grey
PaP-F-BK	Board	Fleece	Black
PaP-R-WT	Wall shelf	Sheet steel	Traffic white RAL 9016
PaP-R-BK	Wall shelf	Sheet steel	Jet black RAL 9005



## Pinboard Line Up

Line Up is a pinboard, shelf and storage space for utensils and accessories - and thus a very elegant and light solution for all intermediate areas in the creative environment, where work areas are to be usefully separated.



### Details

Dimensions H x W x D	180 x 150 x 57 cm
Max. Load capacity	80 kg
Weight	32 kg

### Materials

Structure	Solid wood (Oak or Ash)
Board	Polyester fleece from recycled polyester
Metal parts	powder coated steel in RAL 9005

### Shipping details

Volume shipping weight	50 kg
Packages	4
Shipping method	Freight forwarding

### Options

Board	Grey Fleece, Black Fleece
Castor colors	<input checked="" type="radio"/> <input type="radio"/>

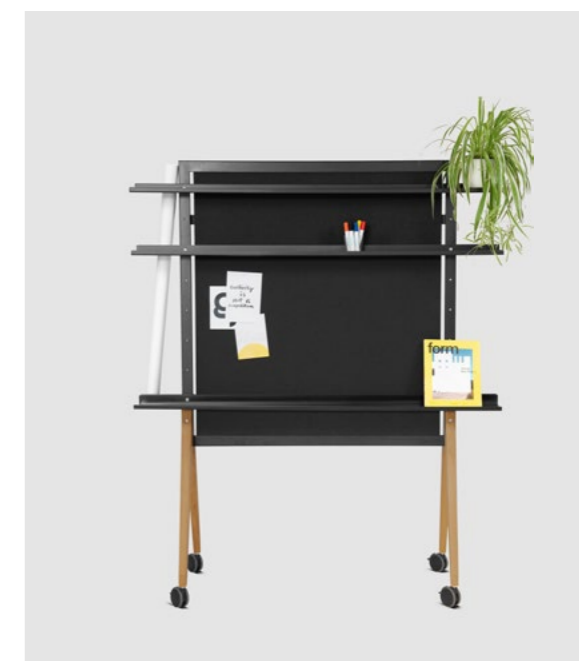

### Artikelnummer

PB-LU-BK150.F-BK.O.1  
PB-LU-BK150.F-BK.O.2

### Rollen

Weiß  
Schwarz





# TV Stands

Whether you hold meetings with teams, Zoom or Google - the TV stands from roomours are the ideal tools to accommodate the necessary equipment for your call, your video conference or for a presentation with customers or colleagues - our TV stands integrate perfectly into different room concepts, are mobile, flexible and above all very stable. The series Front Row, Line Up and Chatterbox can be optimally aligned to your requirements and configured for the most diverse applications.



Front Row



Line Up



Chatterbox

## Front Row – TV Stand

Front Row is the ideal tool for monitors from 45" to 65" and offers enough possibilities to connect different equipment and optional electrification. Front Row fits with its tripod space-saving in any corner of the room and also makes a very good figure. Cameras can be mounted below or above the monitor, and additional elements can be placed on the two shelves.

### Details

Dimensions H x W x D	180 x 96 x 82 cm
max. screen weight	50 kg
max. screen diagonal	65 Zoll
Weight	14,5 kg



### Materials

Structure	Solid wood (Oak or Ash)
Steel elements	Steel sheet, powder coated (RAL 9005)

### Shipping details

Volume shipping weight	26 kg
Packages	2
Shipping method	Freight forwarding

### Options

Woods	
Castor colors	
Optional additions	Power outlet, camera mount, VESA adapter plates

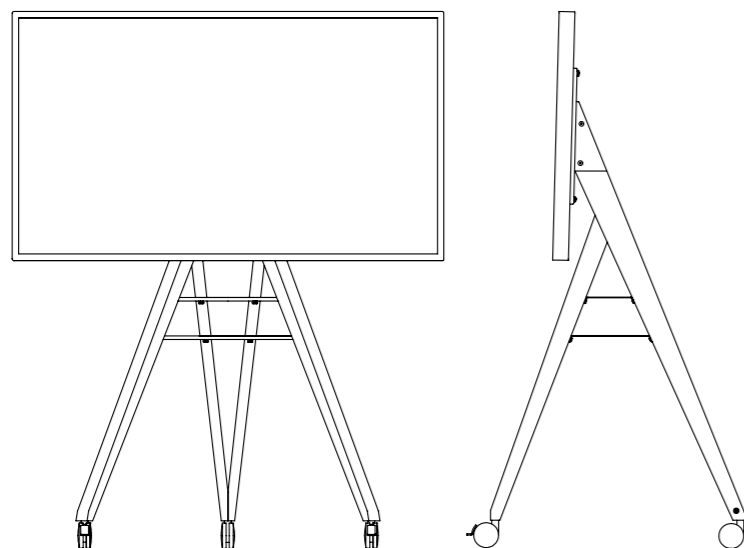

100 // TV STANDS

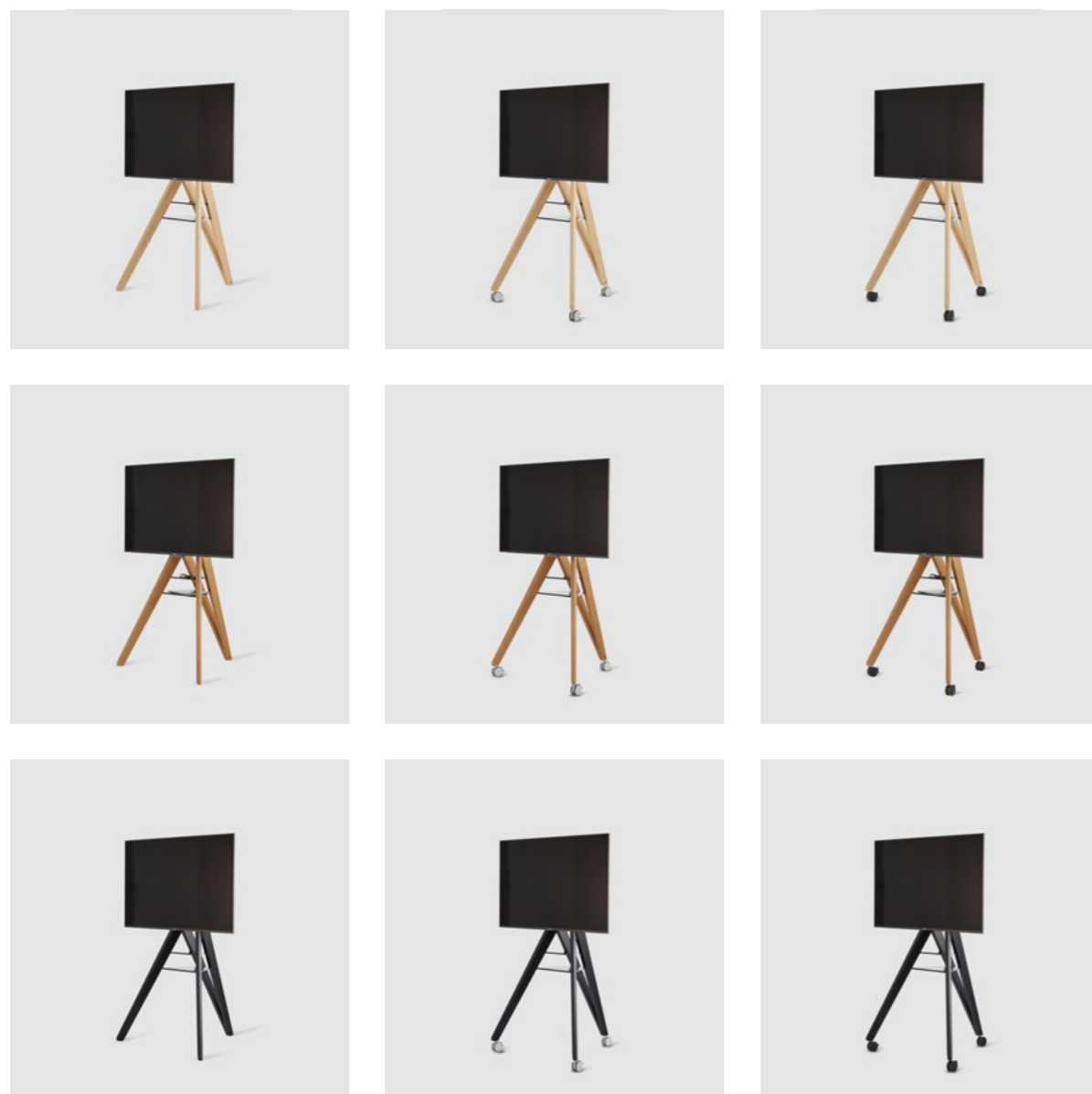

Article number	Wood	Castors
FR-A	Ash	none
FR-A + FR-MS.1	Ash	White
FR-A + FR-MS.2	Ash	Black
FR-O	Oak	none
FR-O + FR-MS.1	Oak	White
FR-O + FR-MS.2	Oak	Black
FR-BK	Ash, stained black	none
FR-BK + FR-MS.1	Ash, stained black	White
FR-BK + FR-MS.2	Ash, stained black	Black



## Front Row – VESA adapter plate

Suitable for all screens with a VESA dimension up to a maximum of 800 x 400 mm. They accept all mounting dimensions in 50 mm increments from 100 x 100 mm up to a maximum mounting dimension of 800 x 400 mm. The adapter plates can be attached variably in height to the Front Row and thus ensure a height adjustment of the monitors in 50 mm steps.

### Details

Dimensions H x W x D	43 x 43/83 x2 cm
Material	powder coated Metall RAL 9005
Weight	4/10 kg

### Shipping details

Volume shipping weight	3/5 kg
Packages	1
Shipping method	Paket

### Compatible VESA standards FR-AP-400

VESA 100 x	100
	200
VESA 200 x	100
	200
VESA 300 x	100
	200
	300
VESA 400 x	100
	200
	300
	400

### additional compatible VESA standards FR-AP-800

VESA 600 x	200
	300
	400
VESA 800 x	200
	300
	400

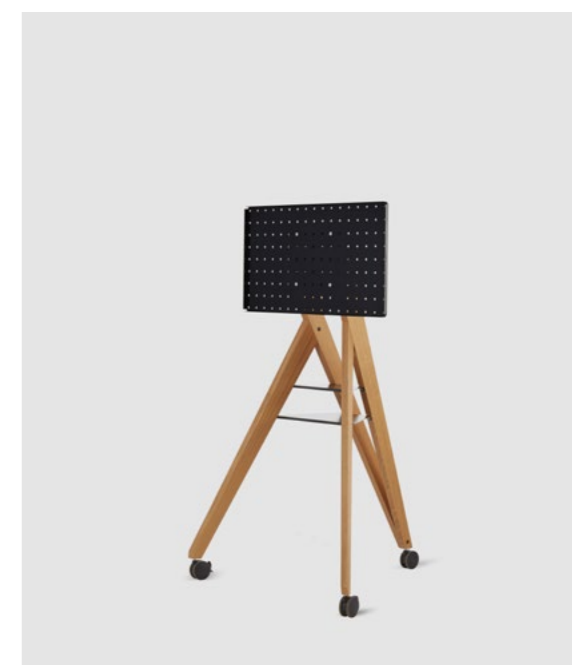
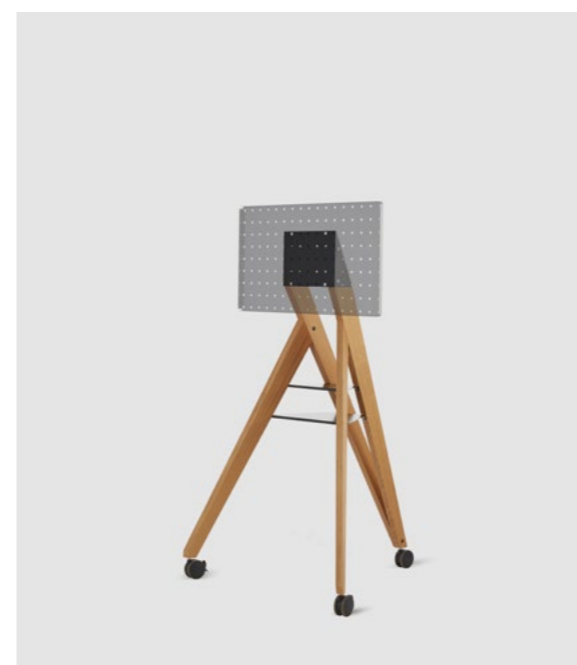
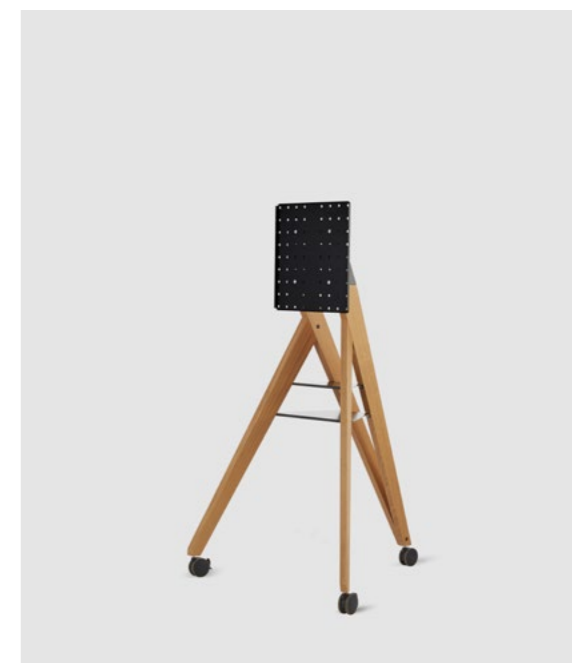
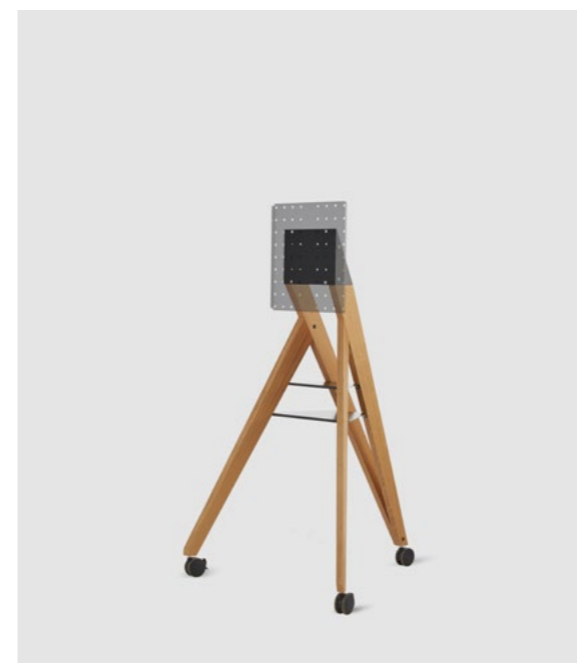

### Article number

FR-AP-400-BK  
FR-AP-800-BK

### suitable up to

VESA 400 x 400  
VESA 800 x 400

## Camera mount and electrification

If you want to use Front Row for video conferencing or digital presentations, you can also expand Front Row with a convenient 6-way power outlet. In addition, you have the option of attaching a camera mount with structural screw on the panel of the socket. Excess cable lengths can be conveniently hung on the integrated hook and thus neatly stowed away.

### Details

Dimensions H x W x D	55 x 15,5 x 14 cm
Weight	4 kg

### Materials

Metall	Sheet steel, powder coated (RAL 9005)
--------	--

### Shipping details

Volume shipping weight	8 kg
Packages	1
Shipping method	Freight forwarding

### Options

Plug type	A, E, F, G, J
-----------	---------------

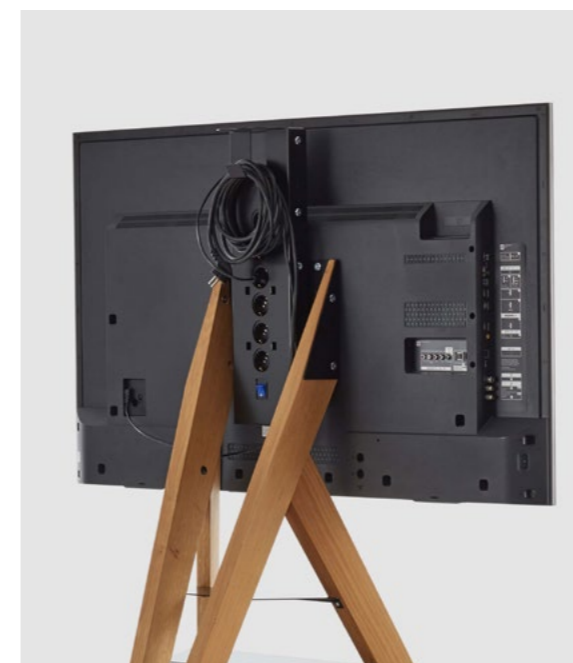
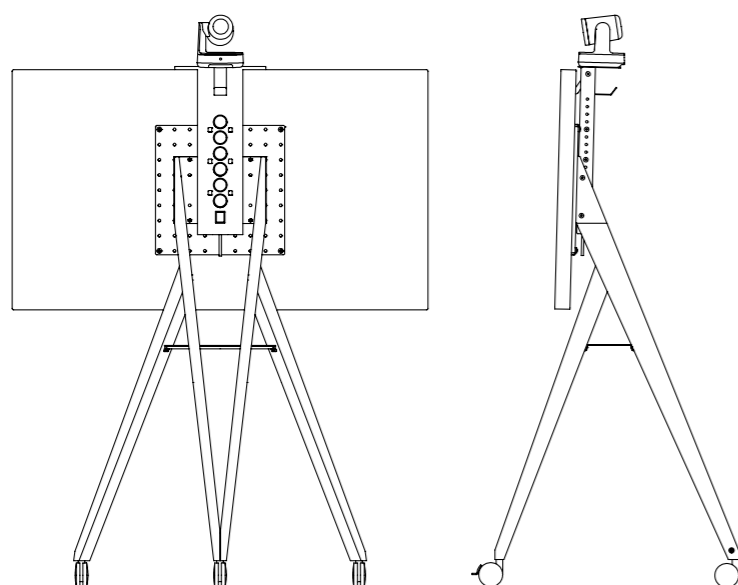

Article number	Plug type
FR-X-F	DE / AT / NL / IT (Typ F)
FR-X-J	CH (Typ J)
FR-X-G	UK (Typ G)
FR-X-E	FR (Typ E)
FR-X-A	USA (Typ A)

## Line Up - TV Stand

Line Up makes it possible to mount large monitors or touchscreens up to a screen diagonal of 85" and a monitor weight of 60 kg with additional equipment such as a camera system, loudspeakers, storage surfaces and electrification, thus configuring the solution that exactly meets your individual requirements.

### Details

Dimensions H x W x D	180 x 150 x 57 cm
Max. screen weight	60 kg
Max. screen diagonal	85 Zoll
Weight	36/38 kg



### Materials

Structure	Solid wood (Oak or Ash)
Steel elements	Sheet steel, powder coated (RAL 9005)

### Shipping details

Volume shipping weight	60 /66 kg
Packages	4
Shipping method	Freight forwarding

### Options

Woods	
Castor colors	
Camera mount	optional

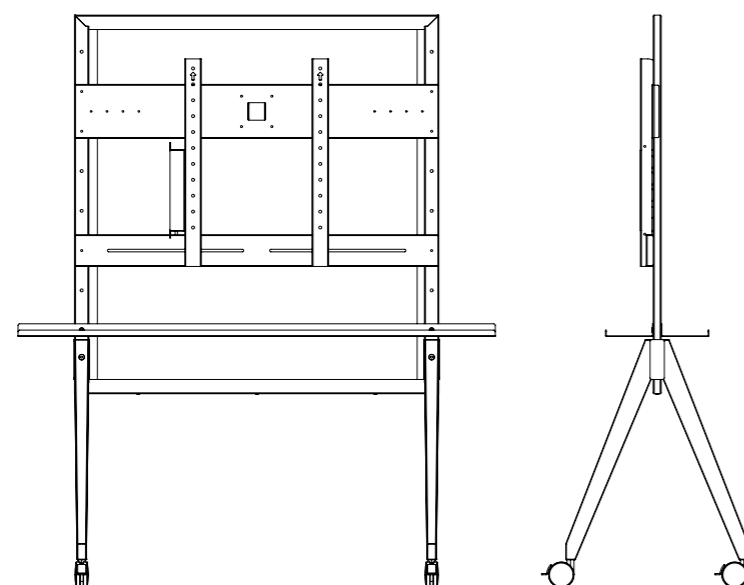



Article number	Wood	Castors	Camera mount
MS-LU-BK150.A.1	Ash	White	no
MS-LU-BK150.A.1 + LU-CM-BKM-BK	Ash	White	yes
MS-LU-BK150.O.1	Oak	White	no
MS-LU-BK150.O.1 + LU-CM-BKM-BK	Oak	White	yes
MS-LU-BK150.BK.1	Ash, stained black	White	no
MS-LU-BK150.BK.1 + LU-CM-BK	Ash, stained black	White	yes
MS-LU-BK150.A.2	Ash	Black	no
MS-LU-BK150.A.2 + LU-CM-BK	Ash	Black	yes
MS-LU-BK150.BK.2	Ash, stained black	Black	no
MS-LU-BK150.BK.2 + LU-CM-BK	Ash, stained black	Black	yes
MS-LU-BK150.O.2	Oak	Black	no
MS-LU-BK150.O.2 + LU-CM-BK	Oak	Black	yes

Fig. left: Optional camera mount for attaching conference systems to the frame.

## Chatterbox

Our Chatterbox is designed as a compact monitor stand and allows to mount large monitors or touchscreens up to a screen diagonal of 85" and a monitor weight of 80 kg with a height adjustment range of up to 30 cm. The entire electrification is housed in the actual box and is then covered by a black fleece element. Thus, the Chatterbox can also be placed freely in the room and is thus an attraction from all sides.

### Details

Dimensions H x W x D	180 x 150 x 62 cm
max. screen size	85 Zoll
max. screen weight	80 kg
Weight	40 kg



### Materials

Structure	Solid wood (Oak or Ash)
Metal parts	Sheet steel, powder coated
Cvoer	Polyester fleece

### Shipping details

Volume shipping weight	51 / 56 kg
Packages	3/4
Shipping method	Freight forwarding

### Options

Woods	
Castor colors	
Metal Colour	

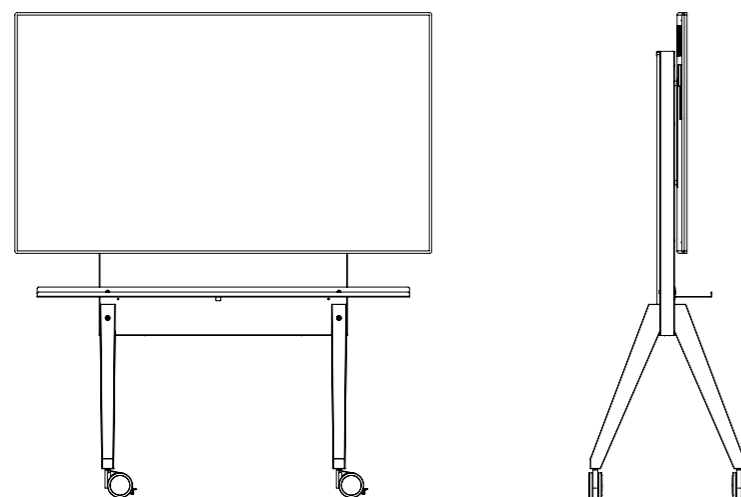





Article number	Wood	Metal	Castors
CB-BK150.A.1	Ash	Jet black RAL 9005	White
CB-BK150.O.1	Oak	Jet black RAL 9005	White
CB-BK150.BK.1	Ash, stained black	Jet black RAL 9005	White
CB-BK150.A.2	Ash	Jet black RAL 9005	Black
CB-BK150.BK.2	Ash, stained black	Jet black RAL 9005	Black
CB-BK150.O.2	Oak	Jet black RAL 9005	Black





Article number	Wood	Metal	Castors
CB-WT150.A.1	Ash	Traffic white RAL 9016	White
CB-WT150.O.1	Oak	Traffic white RAL 9016	White
CB-WT150.BK.1	Ash, stained black	Traffic white RAL 9016	White
CB-WT150.A.2	Ash	Traffic white RAL 9016	Black
CB-WT150.BK.2	Ash, stained black	Traffic white RAL 9016	Black
CB-WT150.O.2	Oak	Traffic white RAL 9016	Black



# Tables

By your Side, Meet & Greet Width Link & Think  
- the side tables from roomours are versatile. At home, in the office or in a seminar, at ideation workshops next to the flipchart or between whiteboards. Alone or in groups.

As storage for everything - from laptops to notepads and pens to drinking glasses. All of a piece and yet universal. Meet & Greet Width Link & Think can also be easily disassembled after use and stored very well space-saving.



Link and Think



Meet and Greet



By your Side

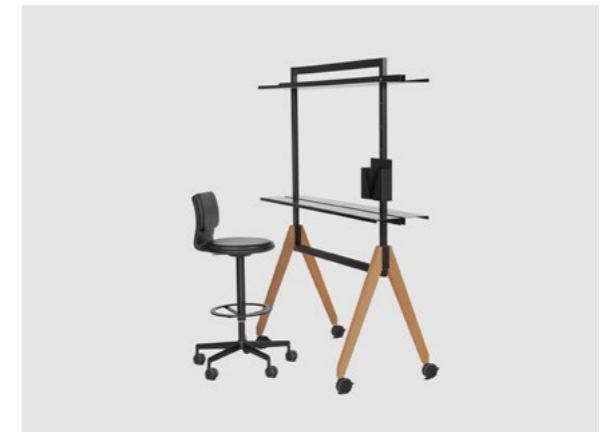

Line Up

## Link and Think

Link & think - the high table with its clear structure is quickly assembled. Shapely and elegant, it is mobile and versatile. After use, it can be folded just as quickly as it was set up and then stored again to save space.



### Details

Dimensions H x W x D	105 x 80 x 80 cm
Load capacity	8 kg
Weight	14 kg



### Materials

Structure	Solid wood (Oak or Ash)
Table top	solid colored MDF core with HPL coating (RAL 7021)

### Shipping details

Volume shipping weight	26 kg
Packages	2
Shipping method	Freight forwarding

### Options

Woods	 
-------	---

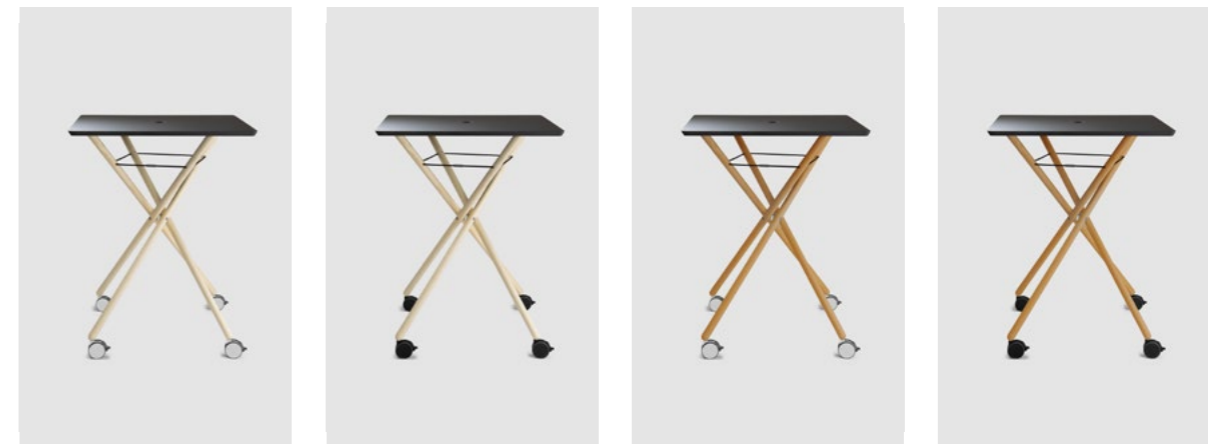
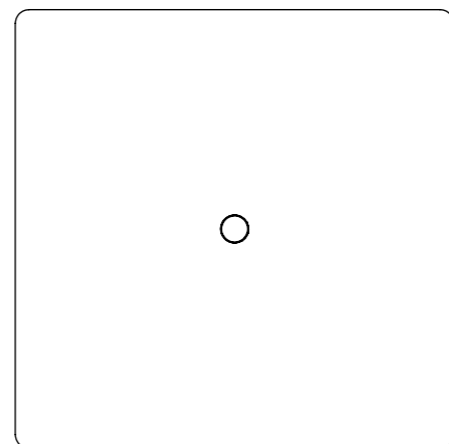
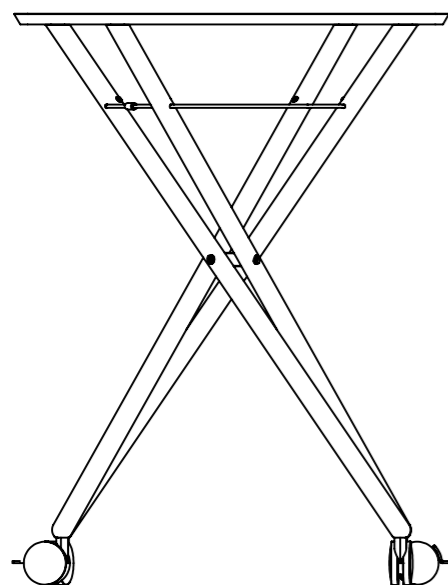

Article number	Wood	Castors
LaT-BK.AR.1	Ash	White
LaT-BK.AR.2	Ash	Black
LaT-BK.OR.1	Oak	White
LaT-BK.OR.2	Oak	Black

## By your Side

From one cast, completely pure Width yet as universal as a Moleskine - By your Side is always u everywhere at hand. A tray for almost everything - from drinking glass to the block to the laptop and thus yet incredibly versatile.



### Details

Dimensions H x W x D	66 x 36 x 40 cm
Load capacity	5 kg
Weight	6 kg

### Materials

Stahl	powder coated
-------	---------------

### Shipping details

Volume shipping weight	25 kg
Packages	1
Shipping method	Freight forwarding

### Options

Colour	<input checked="" type="radio"/> <input type="radio"/> <input type="radio"/>
--------	--

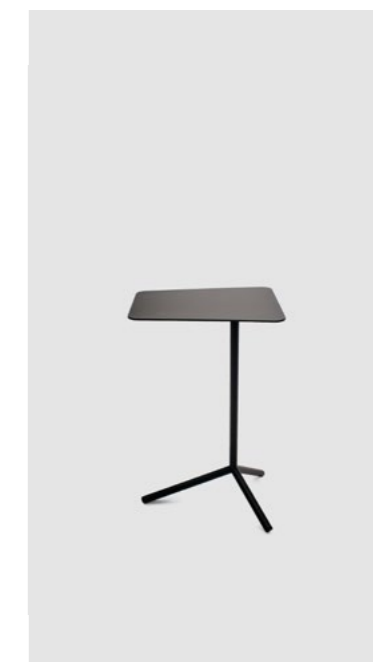
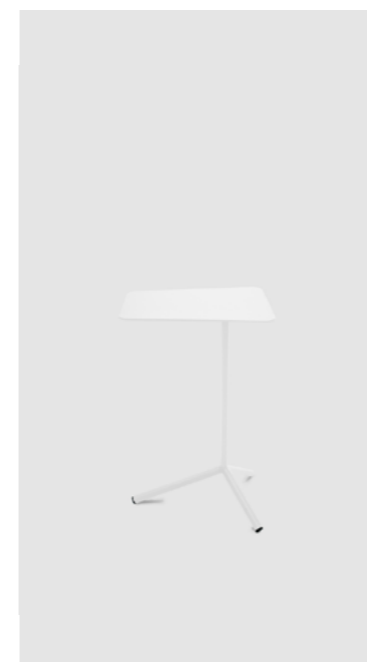
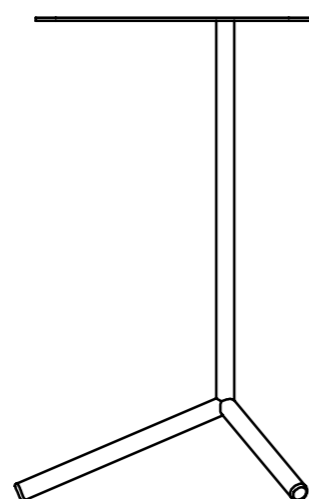
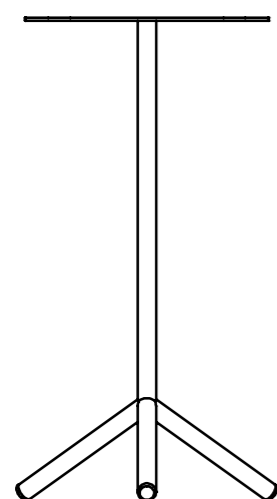

Article number	Colour	
ByS-WT	Traffic white 9016	<input type="radio"/>
ByS-BK	Jet black 9005	<input checked="" type="radio"/>
ByS-RD	Traffic red 3020	<input type="radio"/>

## Meet and Greet

The practical bar table with its three legs is restrained in design and clear in use. With the same principle as Link & Think, it can be easily unfolded to events and receptions and gladly used in many ways.



### Details

Dimensions H x W x D	110 x 60 x 60 cm
Load capacity	8 kg
Weight	10 kg



### Materials

Structure	Solid wood (Oak or Ash)
Table top	solid-colored MDF core with an HPL coating (RAL 7021)

### Shipping details

Volume shipping weight	12 kg
Packages	2
Shipping method	Freight forwarding

### Options

Woods	 
-------	---

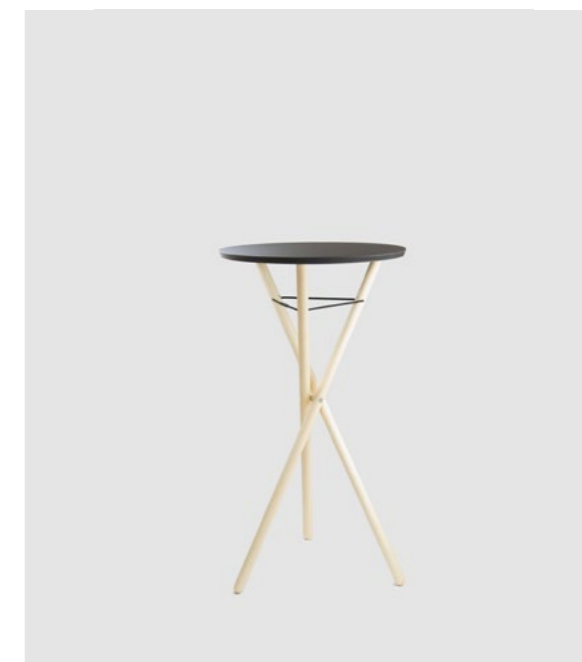
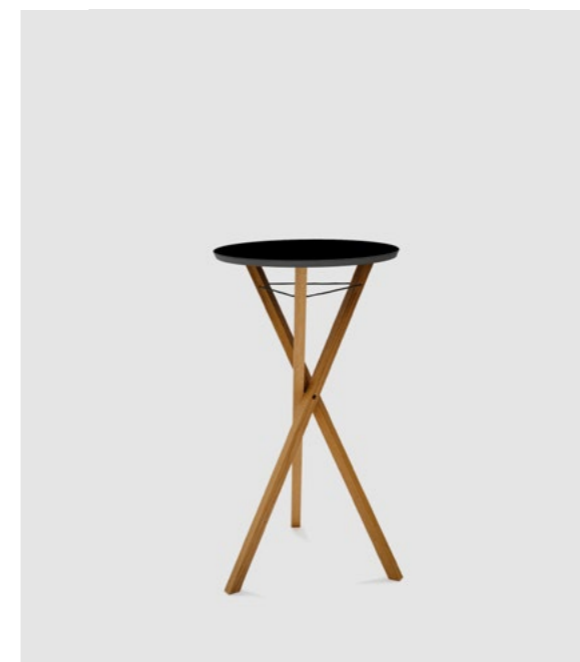
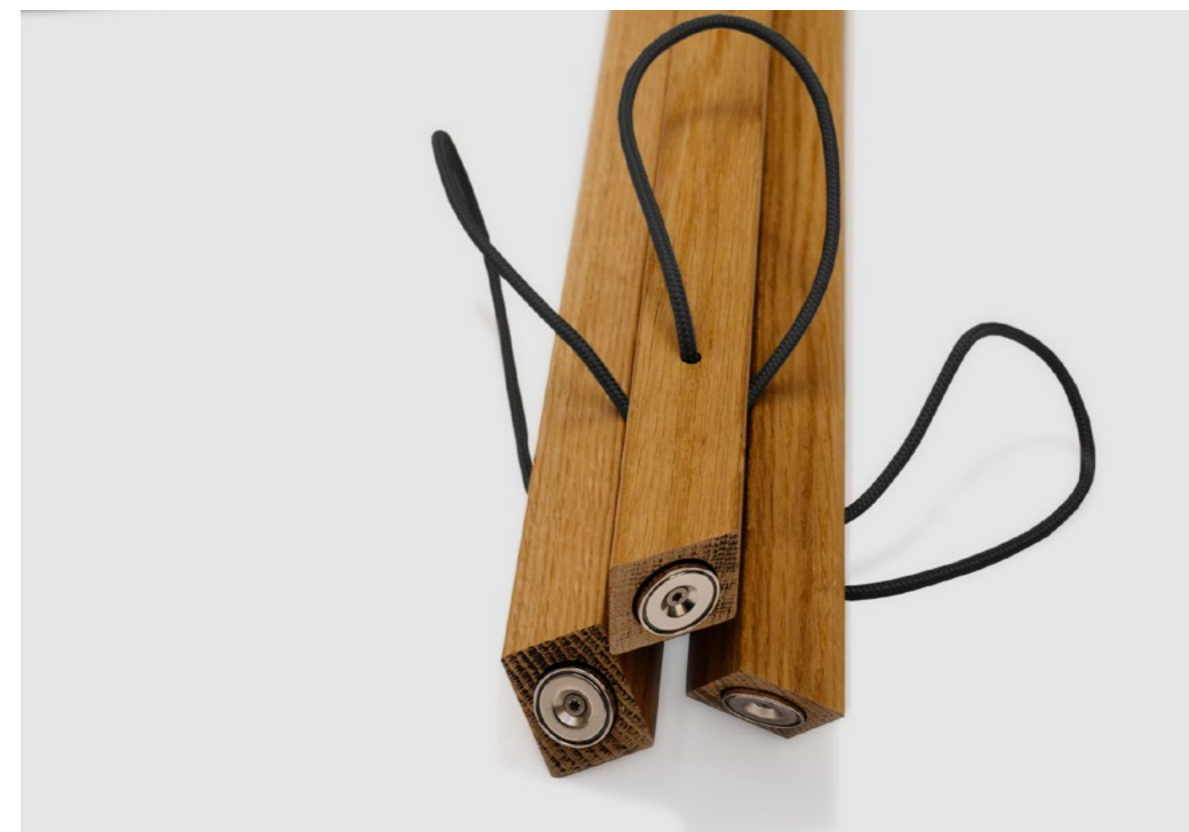
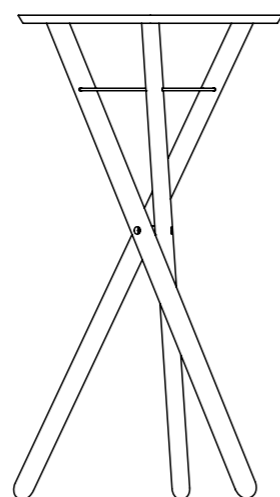
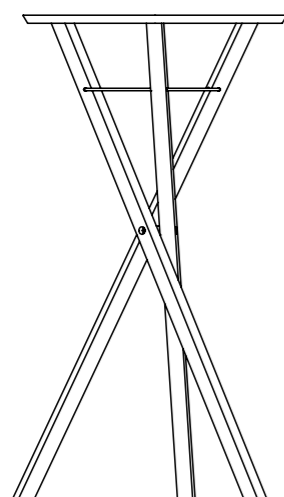

### Article number

MaG-BK.O

MaG-BK.AR

### Wood

Oak, angular

Ash, round

## Line Up - Workstation

The temporary workstation from the Line Up series is the ideal solution for completing smaller tasks in the office or even at home - at Line Up a chat or a team meeting with the laptop or iPad can be carried out quickly. Line Up offers in the basic version a slim work surface and additional optional shelves.

### Details

Dimensions H x W x D	180 x 150 x 57 cm
Weight	32 kg
Height worktop	95 cm
Depth work surface	32 cm

### Materials

Structure	Solid wood (Oak or Ash)
Steel elements	powder coated Sheet steel (RAL 9005)

### Shipping details

Volume shipping weight	52 kg
Packages	5
Shipping method	Freight forwarding

### Options

Castors	<input checked="" type="radio"/> <input type="radio"/>
---------	--

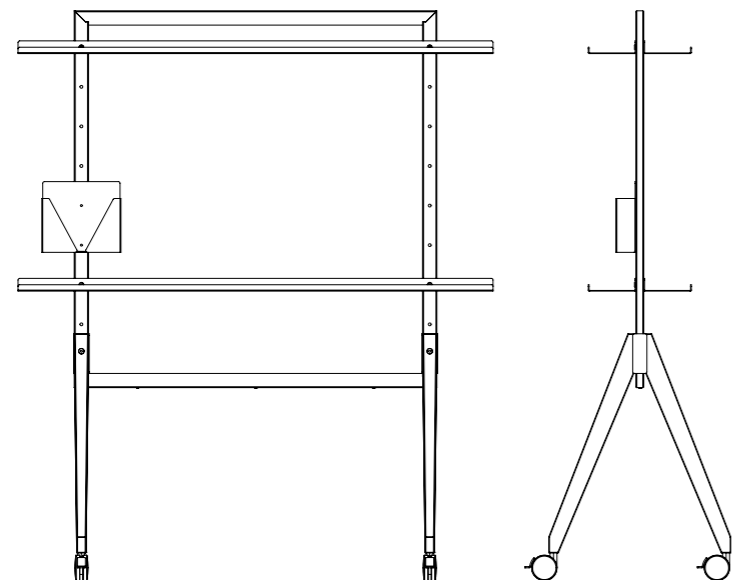

Article number	Castors
WS-LU-BK150.O.1	White
WS-LU-BK150.O.2	Black





# Storage

With the Toolbox and the mobile storage space from the the Line Up series, we now also offer solutions for the better storage and accommodation of materials and tools for your processes. Whether modeling utensils, pens, notation cards or sticky notes, everything should have its place and be available to others after work is done.



**Toolbox**  
mobile utensil container



**Line Up**  
mobile shelf

## Toolbox

All the utensils you use during your workshop, lecture or brain-storming session will find a place here: markers, post it's, index cards, pin needles, magnets, cleaning supplies and much more. The toolbox consists of two elements: The attached utensil container is removable and can be placed on their work tables. The small table on which the utensil container otherwise rests can then also be used individually as a side table.

### Details

Dimensions H x W x D	87 x 46 x 46 cm
Bowl diameter	39 cm
Weight	9 kg

### Materials

Metall	powder coated Sheet steel (RAL 9005)
Inlay	PolyesterFleece

### Shipping details

Volume shipping weight	43 kg
Packages	1
Shipping method	Freight forwarding

### Options

Colour	<input checked="" type="radio"/> <input type="radio"/>
--------	--

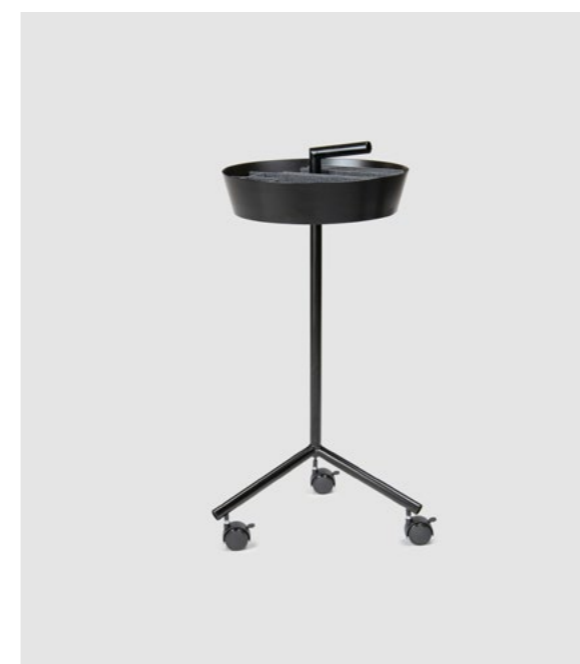
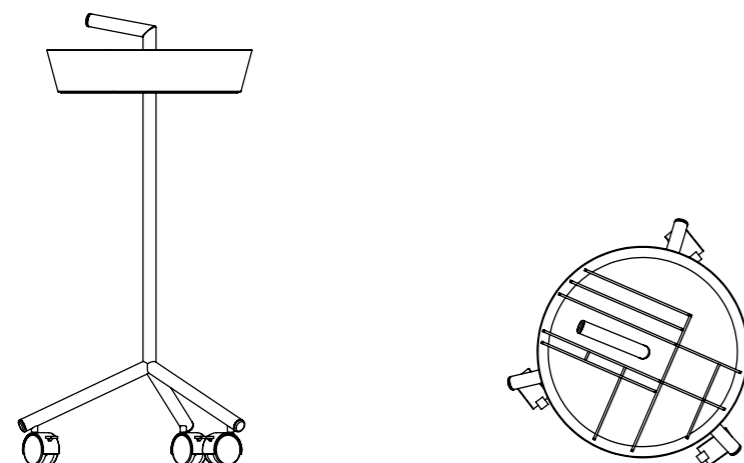

Article number	Colour	
TB-WT.2	Traffic white RAL 9016	<input type="radio"/>
TB-BK.2	Jet black RAL 9005	<input checked="" type="radio"/>

## Mobile shelf Line Up

Line Up is the ideal solution for storing all necessary work tools and accessories, magazines, books that may be necessary as a small reference library for development processes. With that greatly simplify teamwork, as the archive and a material magazine can travel from room to room, as it were. Line Up's storage solution is an ideal solution for ideation and design thinking processes due to its narrow and light structure.

### Details

Dimensions H x W x D	180 x 150 x 57 cm
Total depth shelves	32 cm
Weight	51 kg
Max. Load capacity	80 kg

### Materials

Structure	Solid wood (Oak or Ash)
Frame and shelves	powder coated sheet steel (RAL 9005)

### Shipping details

Volume shipping weight	58 kg
Packages	5
Shipping method	Freight forwarding

### Options

Castor colors	<input checked="" type="radio"/> <input type="radio"/>
---------------	--

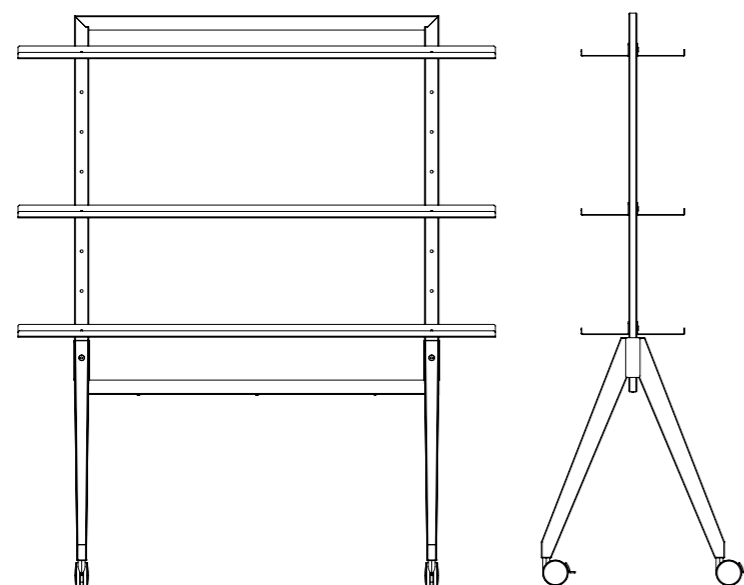

### Article number

SF-LU-BK150.O.1  
SF-LU-BK150.O.2

### Castors

White  
Black



**Accessories and  
product add-ons**

## Add-ons Line Up

Line Up is a very versatile series that offers different solutions for the complex workday. Line Up can be a room divider, pinboard, shelf, storage space and monitor stand, simply adapted to your needs. The flexible system complements our current products in ideation as well as huddle rooms, but is also a very good addition to the classic office environment to achieve a flexible zoning with transparent partition. Line Up can be reconfigured and reconfigured again and again at any time.

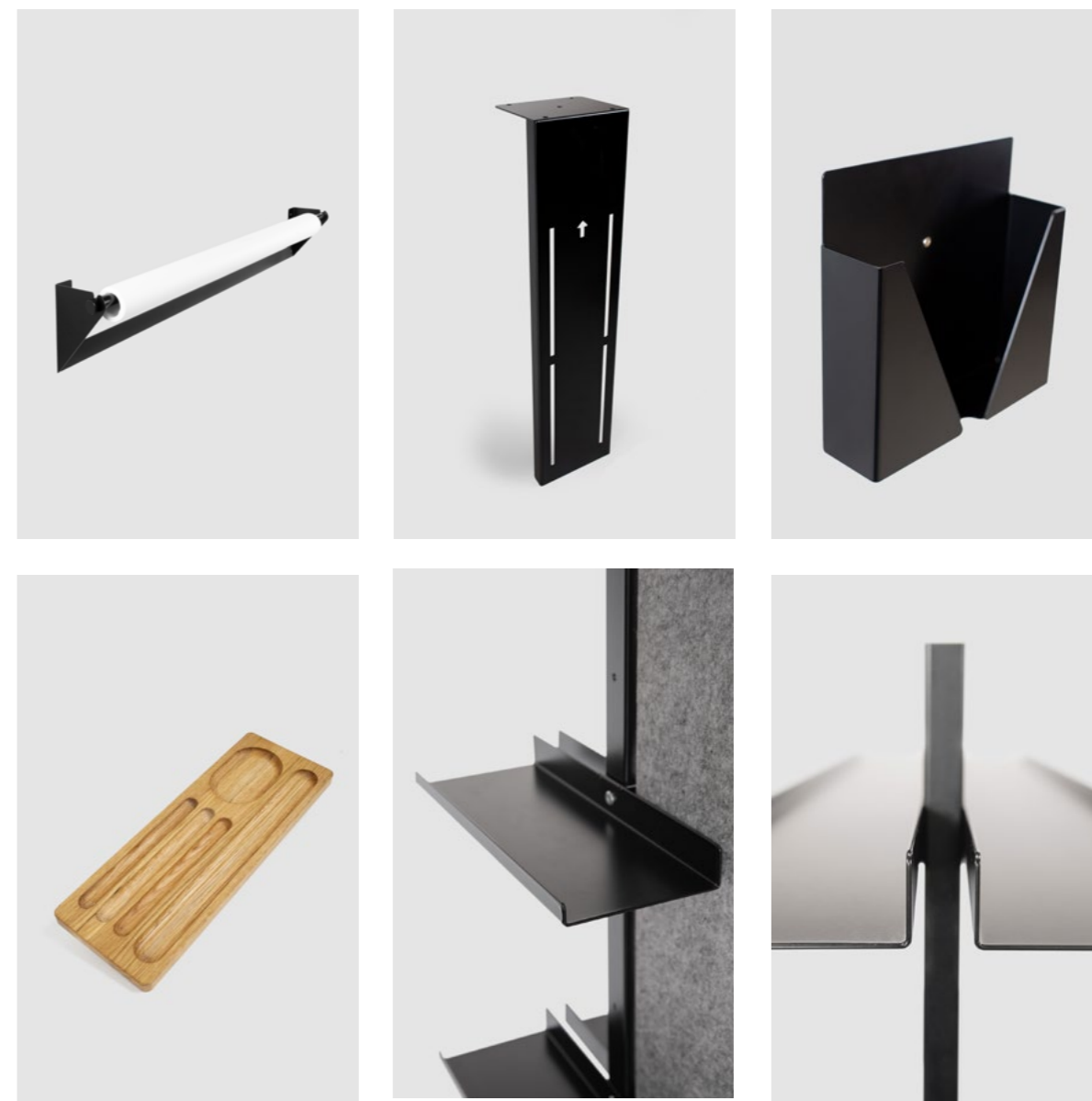

Article number	Name
LU-RH-BK150	Paper holder
LU-CM-BK	Castor holder
LU-MB-BK	Magazine holder
LU-PT.O	Pen tray
LU-SF-BK	Tray
LU-S-BK150	Shelf

## Stationery

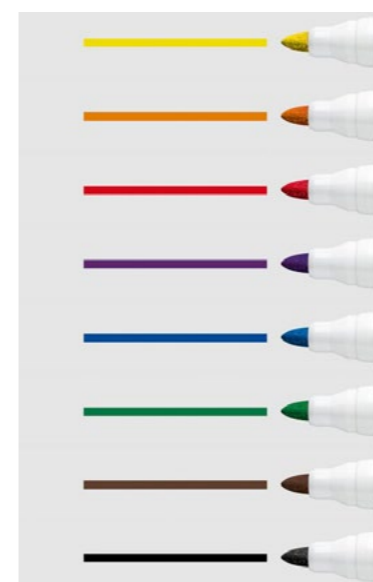

Article number	Name
OM-7x20.10	Magnets, set of 10
FP-RM	Flipchart pads, 10 pieces
P-BK/WT/TP.5x16.100	Pin needles in the tin
WM-8S.RT	Whiteboard marker, set of 8, 2mm
GM-6S-245	Schneider glass board marker Maxx 245, 1-3mm, set of 6
DM-6S-265	Schneider chalk marker Maxx 265, 2-3mm, set of 6

## Cleaning and care



Article number	Name
CU-GR.MC	Microfiber cloth Clean Up
CO-100	Detergent Oranex, 100ml
WP-100	Furniture care oil, 100ml



## Impressum

roomours GmbH  
Blumenstrasse 3  
85540 Haar  
Germany  
VAT number: DE318191360

Commercial register number HRB 240910  
Registered in the Commercial Register of the Munich Local Court

### Contact

Phone: + 49 89 158 922 410  
Mail: office@roomours.de

### Web

www.roomours.de  
Instagram: @roomours\_kommunikationstools  
Pinterest: @roomours\_kommunikationstools  
LinkedIn: roomours Kommunikationstools  
Facebook: roomours.de

### Disclaimer

All prices are exclusive of the applicable statutory VAT and plus the always applicable shipping costs.

All information without guarantee - subject to change, improvements With deviations.

It is expressly noted that the price indicated may have increased since the last update, as real-time updating of the prices indicated above is not always technically possible. The relevant sales price is that which was shown on the website of the online shop www.roomours.de or the respective offer at the time of purchase.

Our General Terms and Conditions of Business apply and can be viewed at <https://www.roomours.de/agb>

# We are here for you!

Do you have any questions, requests or suggestions?

We are happy to be there for you personally and will do our best to answer your request as quickly as possible. You can reach us by phone during business hours from Monday to Friday from 10:00 to 16:00 under +49 89 158 922 410 or by mail to office@roomours.de.

We will be happy to arrange an appointment for an on-site inspection of our products at the time of your choice.

roomours