

Montageanleitung

Installation Instructions
Instructions pour l'installation
Instrucciones de instalación
Istruzioni per l'installazione
Instruções de instalação
Installatie-instructies

1 2x

- Öffnung von SD10×48.5 zeigt zur langen Seite (siehe Bild oben).
Stahldübel so weit wie möglich in das Gewinde eindrehen.
Hole of SD10×48.5 points to the long side (as shown in the picture).
Insert the steel dowel as far as possible into the thread.

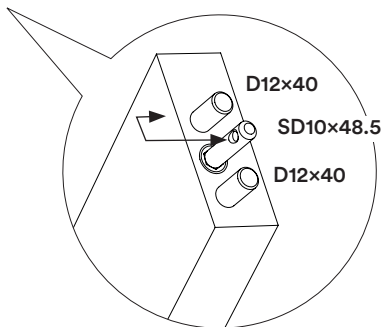
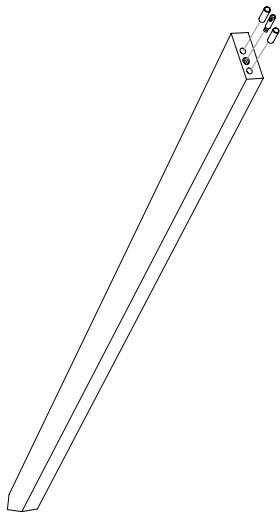

2 2x

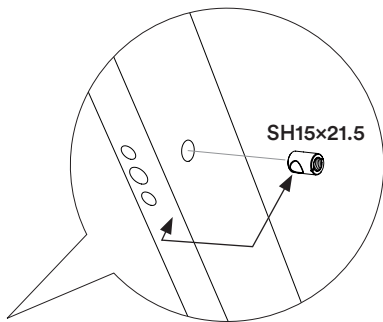
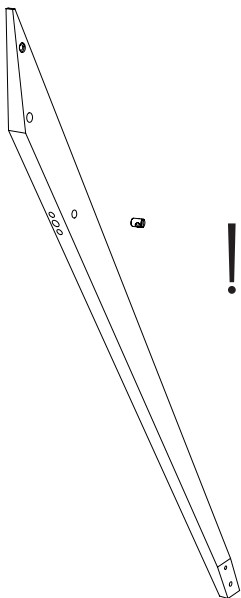

! Die Öffnung von SH15x21.5 zeigt zur schmalen Seite mit den drei Bohrungen (siehe Bild oben).

• The opening of SH15x21.5 points to the narrow side with the three holes (as shown in the picture). **!**

roomours

Front Row Monitorständer

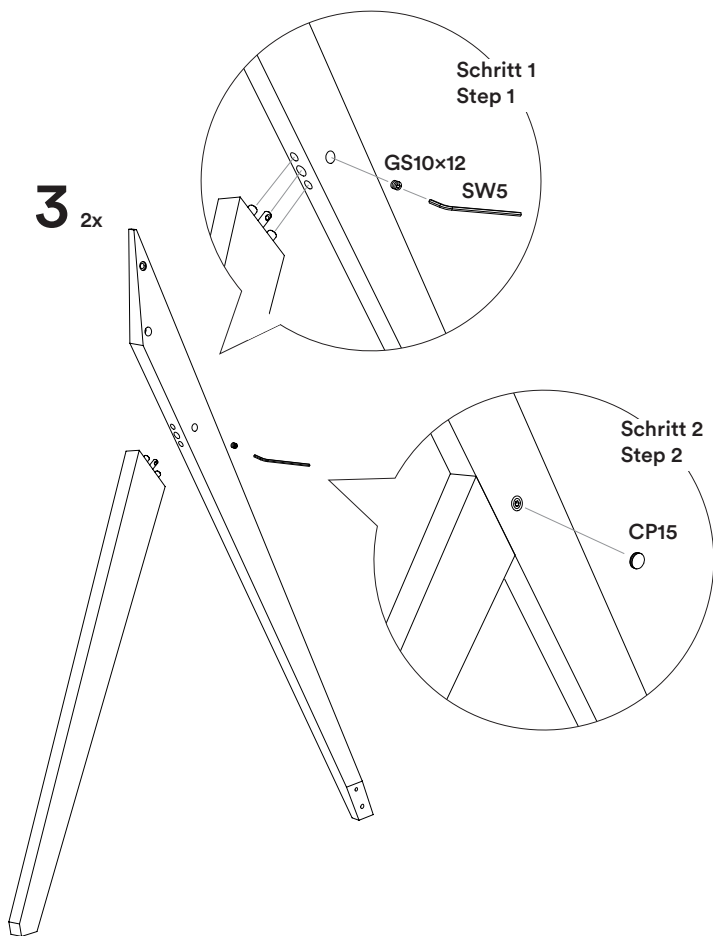

4

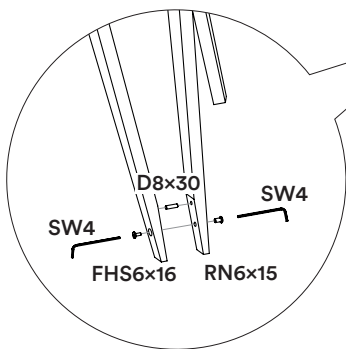
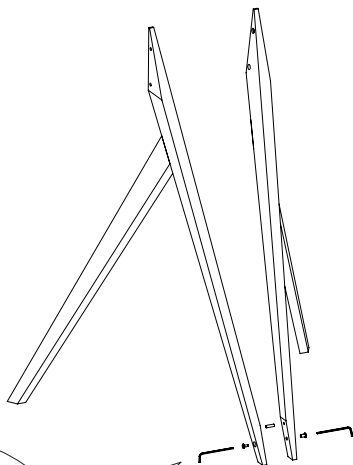

roomours

Front Row Monitorständer

5

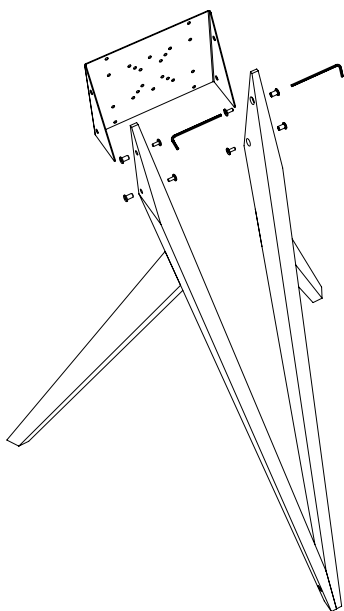
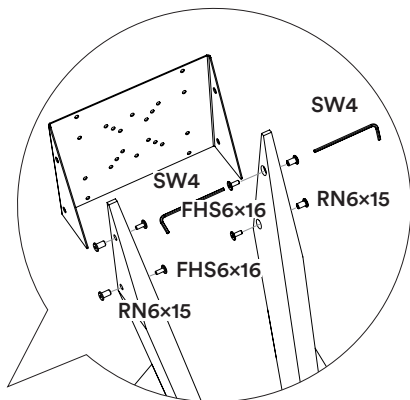

6a

Bei Montage ohne Rollen
For assembly without rollers

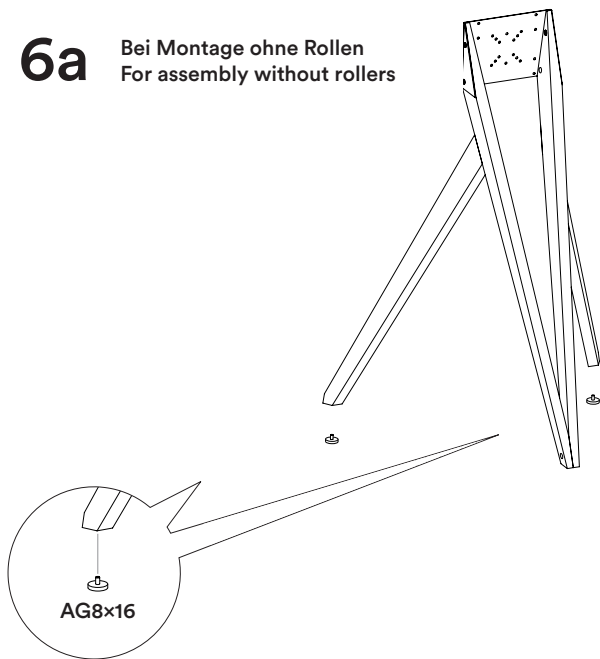

6b Bei Montage mit Rollen For assembly with rollers

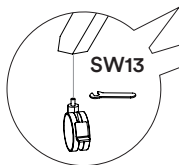
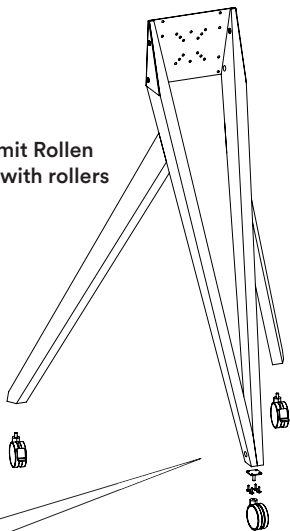

Vorne - Rolle mit Bremse
Front - Castor with wheel brake

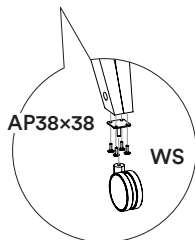

Hinten - Rolle ohne Bremse
Back - Castor without wheel brake

7

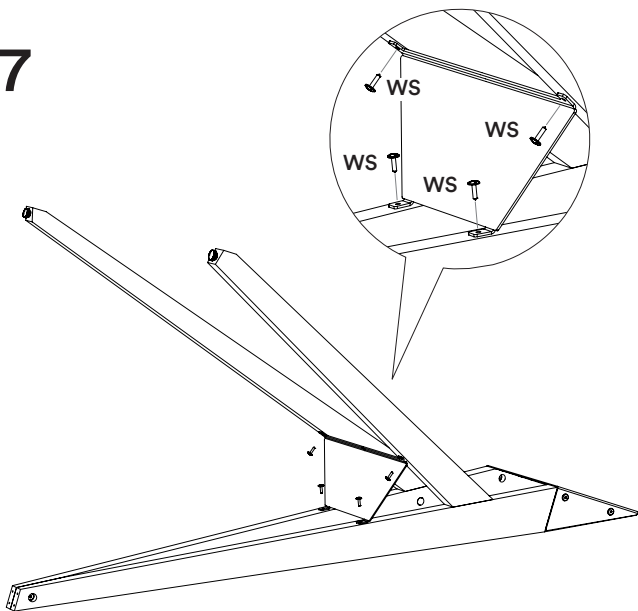

8

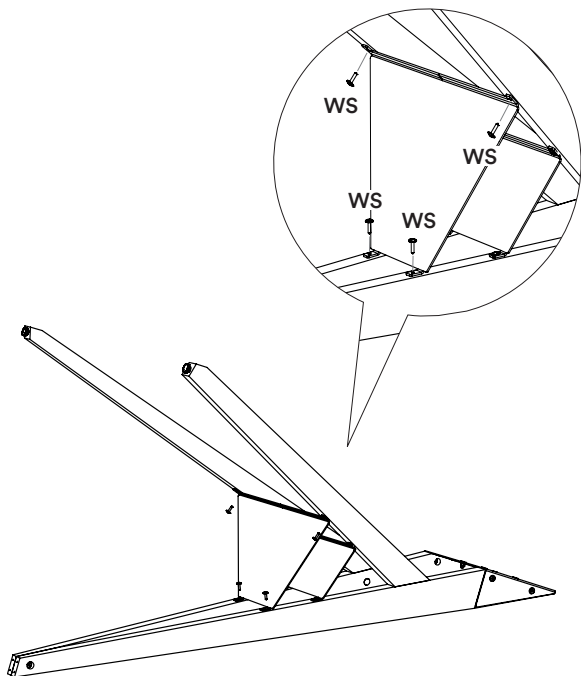

Falls Sie die Adapterplatte (für Befestigungsmaße 30×30, 40×20 oder 40×40) oder das Front Row X für Videokonferenzsysteme bestellt haben, wechseln sie bitte zur entsprechenden Montageanleitung bevor sie ihren Monitor anbringen.

If you ordered the adapter plate (for mounting dimensions 30×30, 40×20 or 40×40) or the Front Row X for video conferencing systems, please change to the assembly instructions before attaching your monitor.

RHS8x25/
RHS8x40/
RHS6x25

9

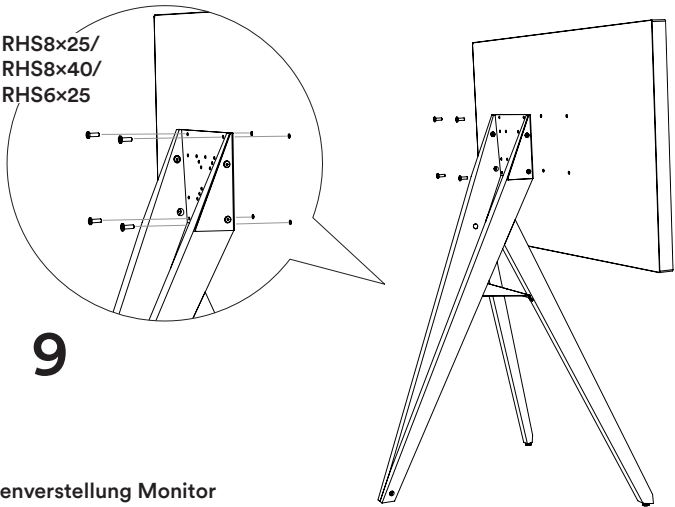

Höhenverstellung Monitor Height adjustment monitor

Minimum height

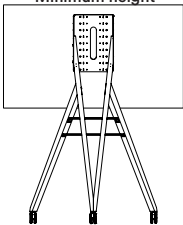

Maximum height

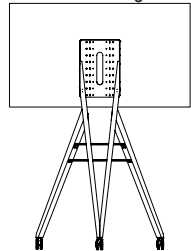

200mm

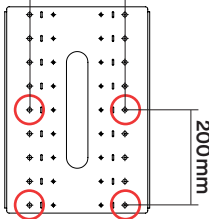

200mm

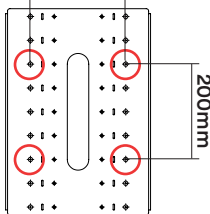



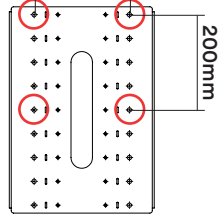







200mm



Front Row Monitorständer

Montage Set, Fitting Set

Bezeichnung Denomination	Anzahl Amount	Darstellung Image
SD10×48.5 10 × 48.5 Stahldübel Steel Dowel	2	
D12×40 12 × 40 Holzdübel Dowel	4	
SH15×21.5 15 × 21.5 Stahlgehäuse Steel Housing	2	
GS10×12 M10 × 12 Madenschraube Grub Screw	2	
CP15 M15 Verschlussstopfen Closing Plugs	2	
FHS6×16 M6 × 16 Flachkopfschraube Flat Headed Screw	5	
RN6×15 M6 × 15 Rundmutter Round Nut	5	
D8×30 8 × 30 Holzdübel Dowel	1	
SW4 SW 4 Inbusschlüssel Allen Key	2	
SW5 SW 5 Inbusschlüssel Allen Key	1	

Front Row Monitorständer

Montage Set, Fitting Set

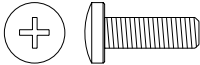
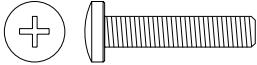
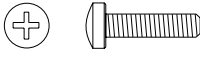
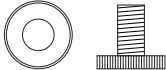
Bezeichnung Denomination	Anzahl Amount	Darstellung Image
WS Holz Schraube Wooden Screw	8/12	
RHS8x25 M8 x 25 Linsenkopfschraube Raised Head Screw	4	
RHS8x40 M8 x 40 Linsenkopfschraube Raised Head Screw	4	
RHS6x25 M6 x 25 Linsenkopfschraube Raised Head Screw	4	
AG8x16 M8 x 16 Stellgleiter Adjustable glide	2	

Bei Montage mit Rollen For assembly with rollers

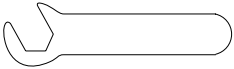
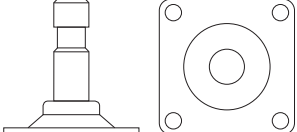
SW13 SW 13 Maulschlüssel Jaw Wrench	1	
AP38x38 38x38 Adapterplatte Adapter Plate	1	

Entsprechend dem Gewinde am Bildschirm bitte die Schrauben **RHS8x25**, **RHS8x40** oder **RHS6x25** verwenden!

According to the thread on the screen please use screws **RHS8x25**, **RHS8x40** or **RHS6x25**!

Geeignet für Bildschirme bis zu 50kg!

Suitable for screens up to 50kg!