

Montageanleitung

Installation Instructions
Instructions pour l'installation
Instrucciones de instalación
Istruzioni per l'installazione
Instruções de instalação
Installatie-instructies

Wichtiger Hinweis

Bei den **VESA Standard Maßen** 400×200, 400×300, 400×400, 600×200, 600×400, 700×400 und 800×400 bitte den Montageschritten in der **Montageanleitung 1** folgen.

Bei den VESA Standard Maß 300×300 und 300×200 bitte nach der **Montageanleitung 2** den Monitor anbringen.

Important note

For **VESA standard dimensions** 400×200, 400×300, 400×400, 600×200, 600×400, 700×400 and 800×400 please follow the mounting steps in **mounting instruction 1**.

For VESA standard dimension 300×300 and 300×200, please follow the mounting steps in **mounting instruction 2**.

Montageanleitung 1

Mounting instruction 1

1.1

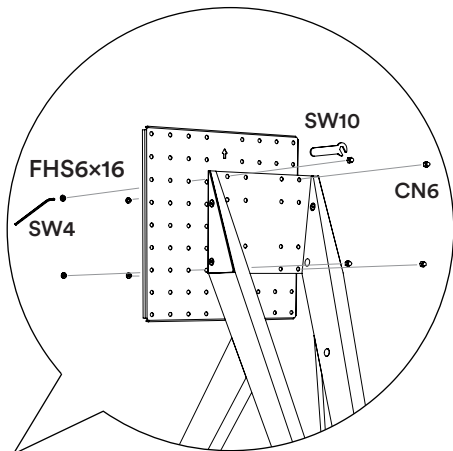
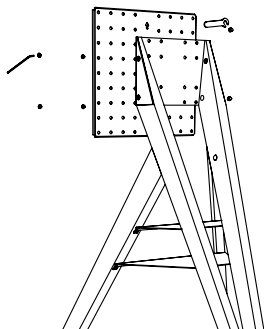

Eine Höhenverstellbarkeit ist über die Position möglich, in der die Adapterplatten aneinander geschraubt sind. Siehe Zeichnung unten.

Height adjustability is possible via the position in which the adapter plates are screwed together. See drawing below.

Höhenverstellung Monitor

Height adjustment monitor

Minimum height

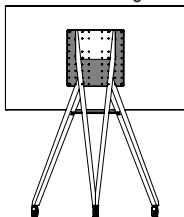

Maximum height

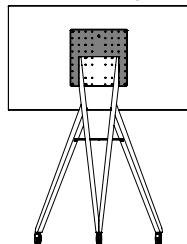
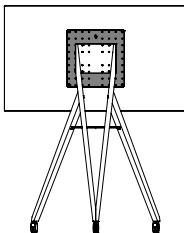

Montageanleitung 1

Mounting instruction 1

1.2

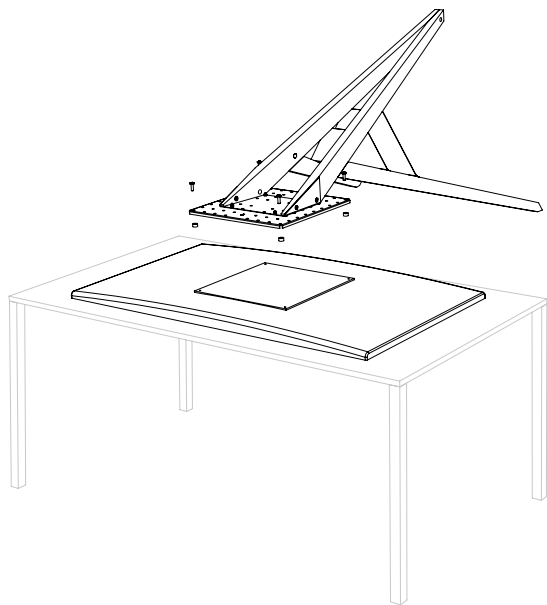
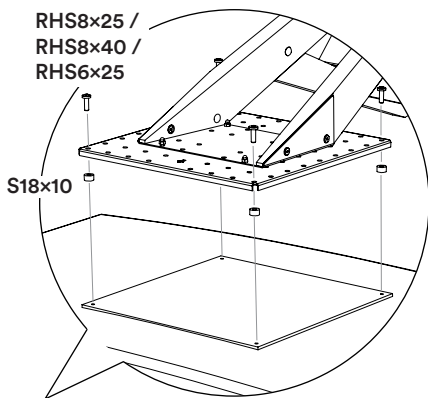

Montageanleitung 2 Mounting instruction 2

Wichtiger Hinweis | Important note

Bitte zuerst die Position der Schrauben festlegen. Sie entscheidet über die Höhe in der der Monitor montiert wird.

Please determine the position of the screws first. It determines the height at which the monitor is mounted.

Höhenverstellung Monitor Height adjustment monitor

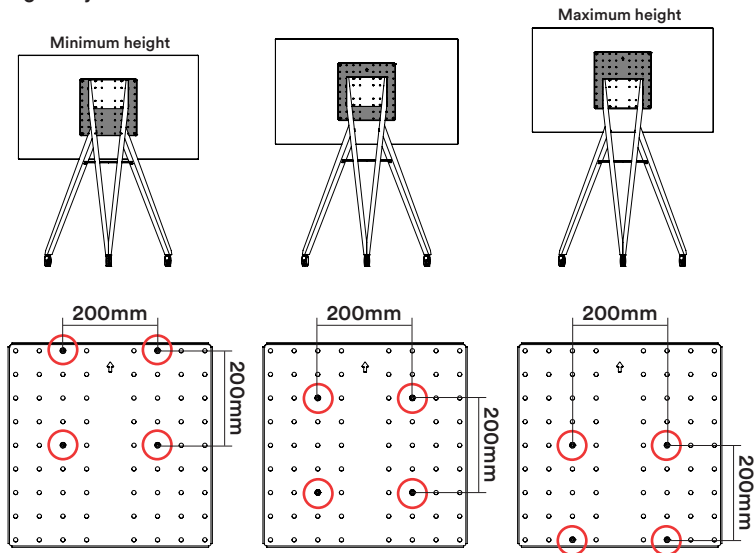

Montageanleitung 2

Mounting instruction 2

2.1

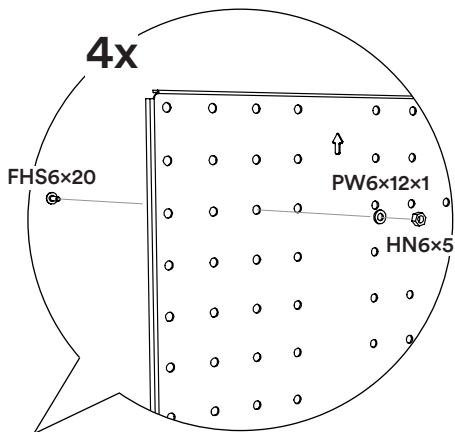
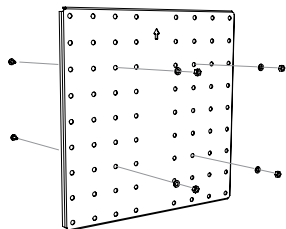

Beispiel für mittige Montage
Example for central mounting

roomours

Front Row Serie
Adapterplatte 400
Adapterplatte 800

2.2

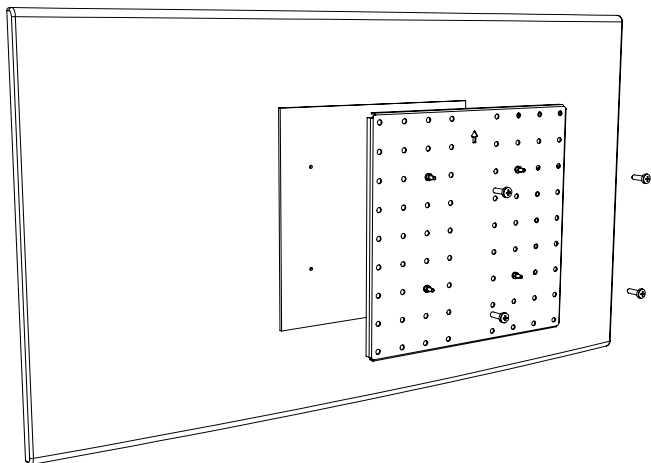
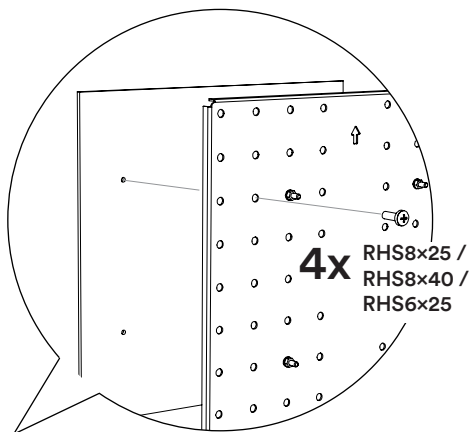



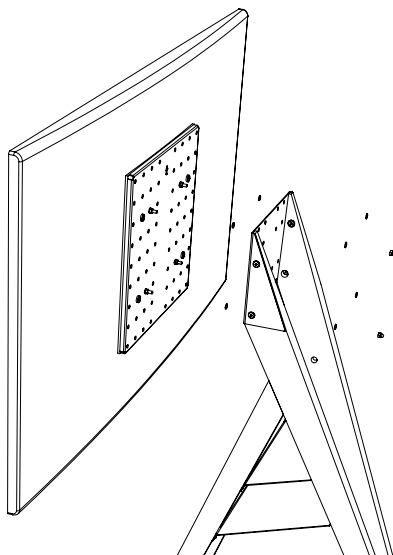
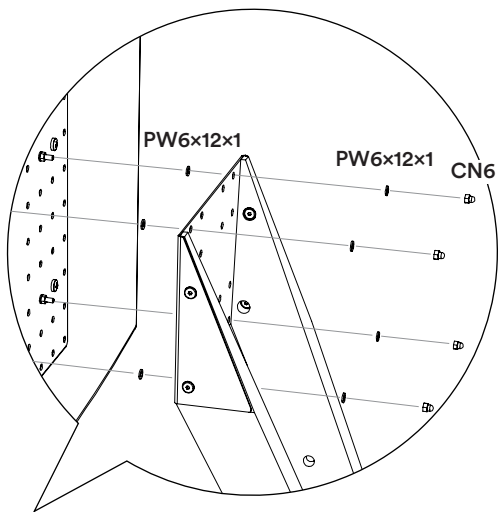

2.3

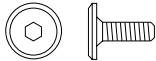
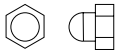
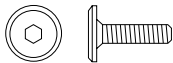

Front Row Serie Adapterplatte 400 / Adapterplatte 800

Montage Set, Fitting Set

Bezeichnung Denomination	Anzahl Amount	Darstellung Image
S18x10 18 x 10 Distanzhülse Spacer	4	
FHS6x16 M6 x 16 Flachkopfschraube Flat Headed Screw	4	
CN6 M6 Hutmutter Cap Nut	4	
FHS6x20 M6 x 20 Flachkopfschraube Flat Headed Screw	4	
PW6x12x1 6 x 12 x 1.5 Unterlegscheibe Pastic Washer	12	
HN6x5 M6x5 Sechskantmutter Hexagon Nut	4	
SW4 SW 4 Inbusschlüssel Allen Key	1	
SW10 SW 10 Maulschlüssel Jaw Wrench	1	

Entsprechend dem Gewinde am Bildschirm bitte die Schrauben **RHS8x25**, **RHS8x40** oder **RHS6x25** verwenden! Die Schrauben finden Sie im Montageset Front Row Screen Rack bzw. Front Row on Tour Screen Rack.

According to the thread on the screen please use screws **RHS8x25**, **RHS8x40** or **RHS6x25**! The screws can be found in the mounting kit Front Row Screen Rack or Front Row on TourScreen Rack.