



DCS

PIONEERS. SINCE 1989

dcsappliances.com

YOUR OUTDOOR KITCHEN IS YOUR WORKSHOP

It's a place of purpose and focus, where paths are forged and instinct is your guide, where steak earns its stripes, where flavor becomes an obsession and ingredients are transformed.

PERFECTING THE ART OF GRILLING

The desire to constantly challenge the status quo and push boundaries is expressed deeply in our design language and our approach to redefining what the grill should be. Drawing upon the performance, durability and dependability of commercial kitchens, our founders took this as inspiration to transform the outdoor cooking experience.

This maverick attitude is at our core. It is what inspires us to think big and not to settle for 'good enough'.

Our vision is much grander.



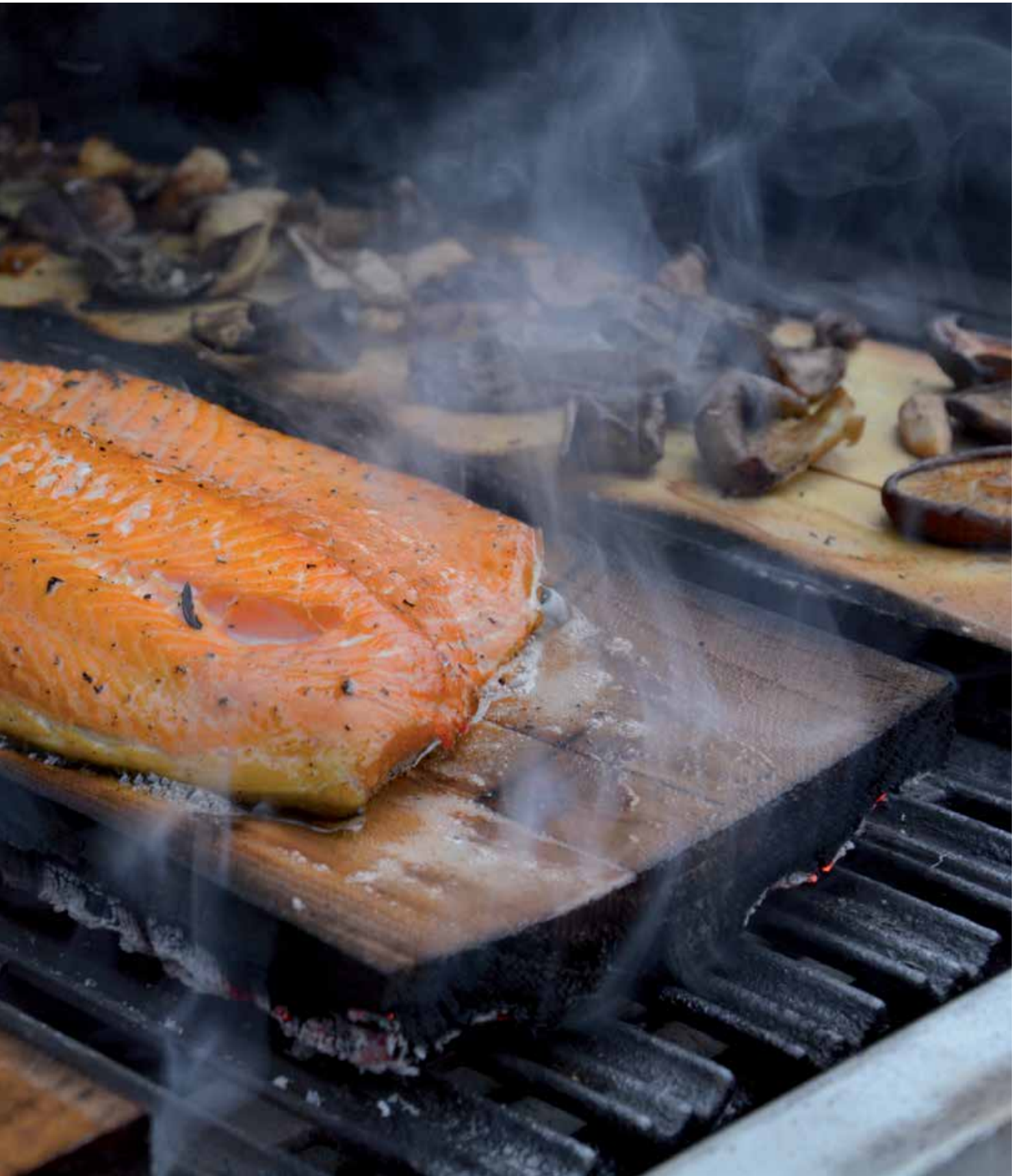

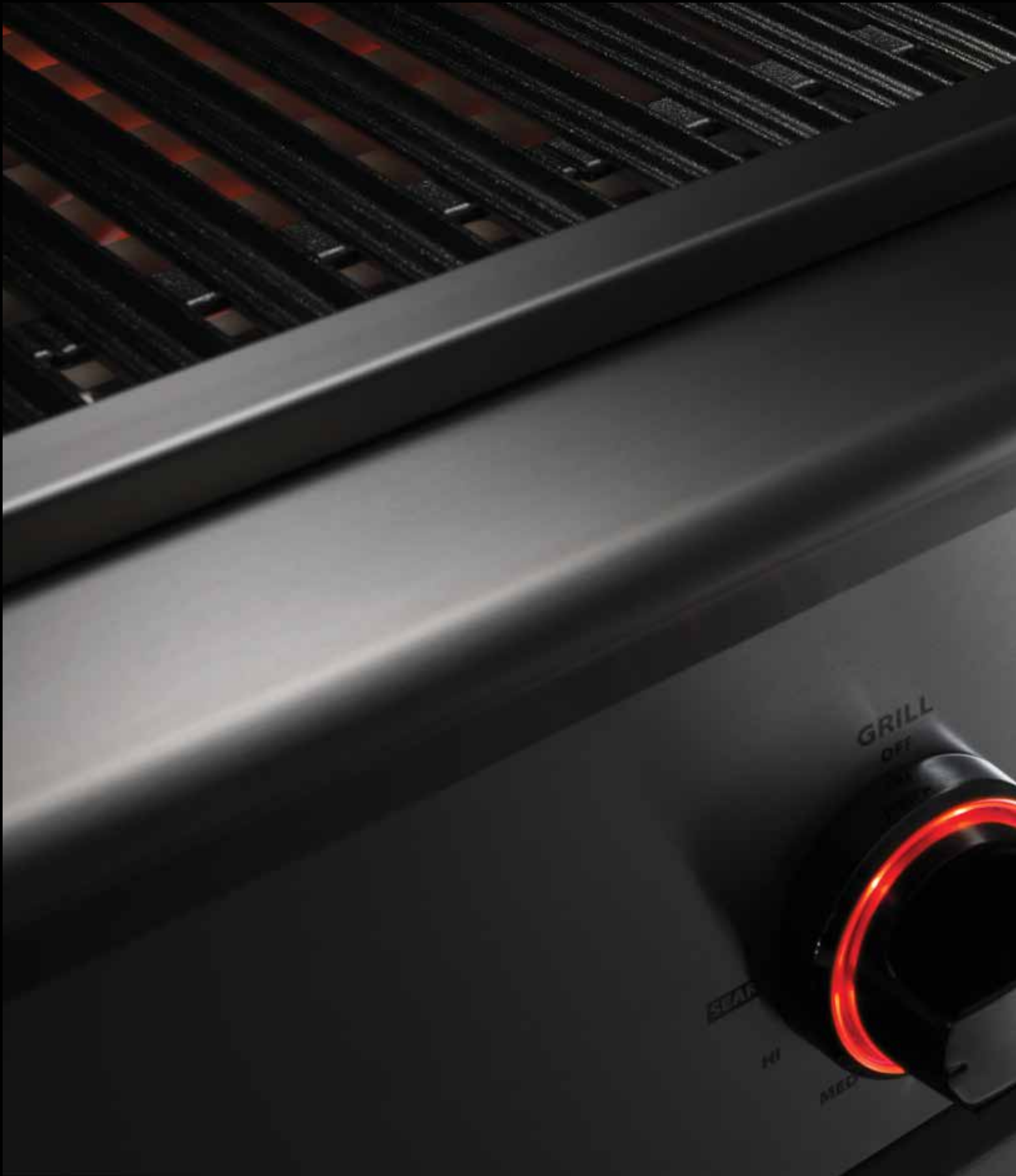



CRAFTING A LEGACY

Every DCS product is hand-finished, a tradition that has been carried on since our first grill was crafted in 1989. It is how we guarantee our workmanship, and the attention to detail we put into our products.

The outdoor environment is unforgiving, so we pride ourselves on delivering grills and accessories that are solid, hardwearing and durable.

We fabricate from heavy duty 304 stainless steel for its resistance to corrosion and oxidation, with all welded joints hand finished for long-lasting quality.



THE PERFECT HEAT

Take charge of your tools.
Choose your method. Select the best
ingredients. Control the heat. Develop
the flavors. Season to taste.

Enjoy Delicious.

SEAR

“A good sear allows you to effectively seal in moisture and add flavor to anything you’re cooking. In most cases you’re only as good as your equipment. Having the professional level output of these outdoor kitchens allows me to duplicate restaurant performance with ease.”

Chef Michael Scelfo – Founder and head chef at Boston restaurants Alden & Harlow and Waypoint







CHARCOAL GRILL

“The smoke from the charcoal adds flavor to whatever is cooking. In a charcoal grill, I look for something that will give me a great flavor, first and foremost. Then, I want to make sure that the grill can reach very high temperatures and I have the ability to manipulate the heat up and down quickly.”

Chef Ludo Lefebvre – Founder of Los Angeles restaurants Petit Trois, Trois Mec and Trois Familia



BAKING

"If you want to utilize your grill like an oven, it is important to have even heat everywhere in the grill so that you can cook everything evenly and build a nice crust."

Chef Michael Scelfo

BOILING AND DEEP FRYING

“For any large scale boil, it is imperative to have a very strong flame. Boiling a large amount of liquid in a large pot takes a long time and once you add all of your ingredients to the water, you need a strong heat source to bring the liquid back up to temperature quickly. Otherwise, the process takes far too long.”

Chef Ludo Lefebvre



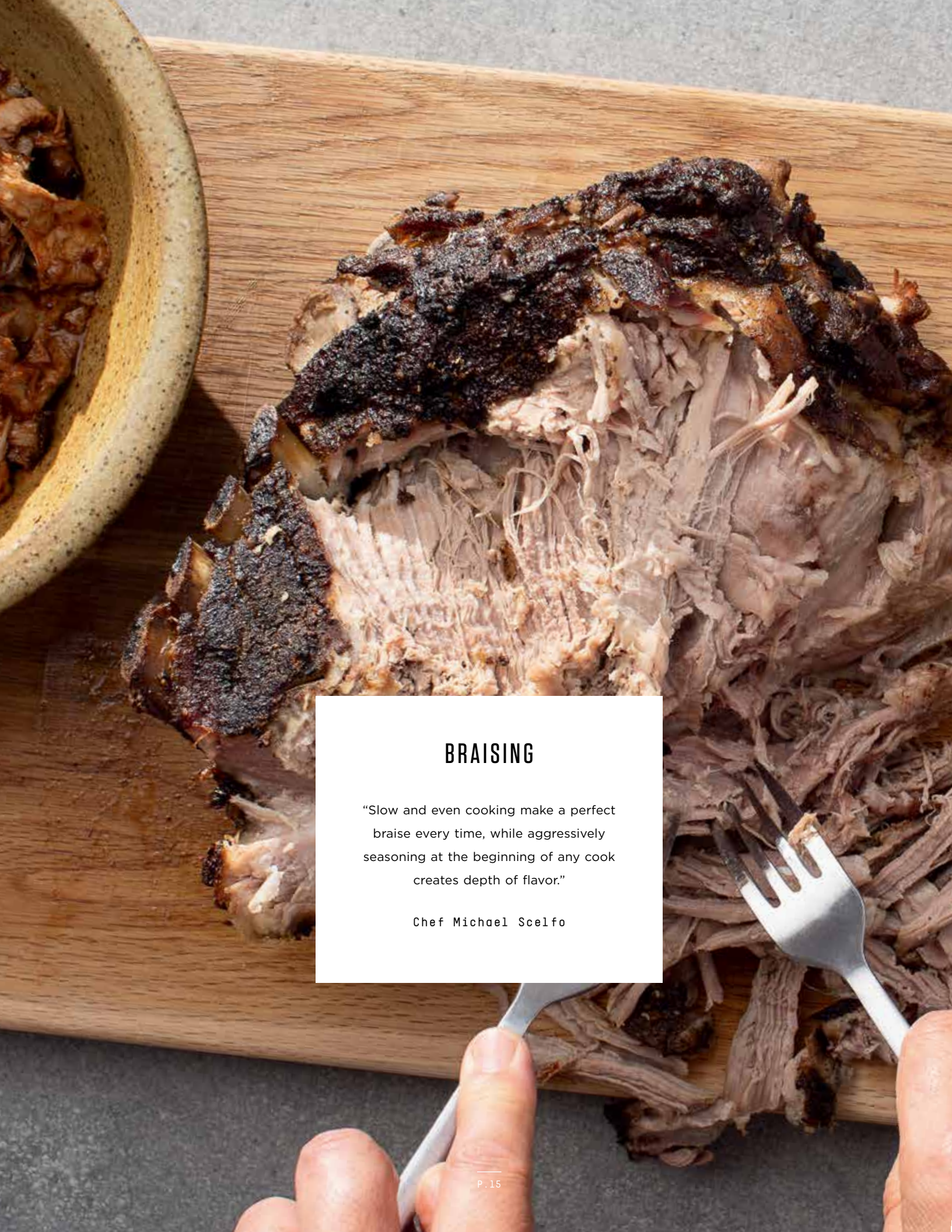

BRAISING

“Slow and even cooking make a perfect braise every time, while aggressively seasoning at the beginning of any cook creates depth of flavor.”

Chef Michael Scelfo



SMOKING

“Smoke adds depth and character to just about anything you’re working with, it compliments everything.”

Chef Ludo Lefebvre

ROTISSERIE

“Each technique has its purpose, but with rotisserie it is easier to build a crust with basting and to make any meat or fish crispy pretty quickly, which is something that I love. It is important to have a high-quality power source that can create a strong flame to keep high and even heat while cooking. The rotisserie spit should not spin too fast - it should be slow enough to add a nice caramelization to the meat on the outside.”

Chef Ludo Lefebvre



WOK COOKING

“Good wok cooking requires a strong flame - it should be extra hot and very powerful in order to heat the entire wok.”

Chef Ludo Lefebvre





GRIDDLE

“Adding a griddle to your outdoor kitchen allows you to do so much more from pancakes and bacon to fish and vegetables. The key is a griddle surface that is responsive, giving you total control over the heat.”

Chef Paul Mounsey – DCS Global
Cooking Experience Manager





THE DCS DIFFERENCE

With an obsessive focus on cooking, we design and engineer grills and cooking attachments that deliver perfect results – whether that is a well-seared steak or meltingly tender ribs – while also being intuitive to use, cleverly designed and durable for years of enjoyment.

Our pillars inform the design of every DCS appliance.

PROFESSIONAL RESULTS

Explore precise performance when creating professional results, from searing to slow roasting, smokey to clean and everything in-between.

BEAUTIFUL TO USE

Experience equipment that beautifully balances design and functionality allowing you to always be in control.

BUILT TO LAST

Robust hand-finished 100% stainless steel construction with exceptional warranties. Made from durable materials designed to withstand all types of weather.

DESIGNED TO FIT

Create your ideal outdoor lifestyle with grills and complementary products that are designed to match and work together as one.

RESPECT FOR FOOD

Customize and fine tune every aspect of outdoor cooking to respect the provenance of the finest ingredients.





GRILLS

The centerpiece of the outdoor kitchen, you need your grill to handle anything you throw at it — or on it. Built from 304 grade stainless steel and delivering 25,000BTU of power, these grills combine premium styling with thoughtful design to deliver powerful performance and flexible grilling solutions.

Core, premium functionality like full surface searing, a powerful rotisserie and our Grease Management System™ are standard across both Series 7 and Series 9 Grills. Designed for unparalleled control and power and hand-finished to a high standard, these grills are built to withstand the demands of the serious cook as well as the weather.

DCS Series 9 Grills build on this with added features like a charcoal smoker tray with hot surface flame ignition, more indirect cooking racks for braising and baking, and premium design styling with an easy-to-open spring assisted lid.

Grills

SERIES 9 GRILLS

Handcrafted for serious cooks, the DCS Series 9 Grill delivers exceptional cooking performance. Designed for unparalleled functionality and power and hand-finished to a high standard, these grills are built to withstand the demands of the serious cook and the weather, 365 days a year.

Available in 36" and 48" grills.
6" spacers are available to extend
grill to fit a 42" and 54" cavity.

*Lifetime warranty on: Stainless Steel Grill Burners, Stainless Steel Grill Cover, Burner Box, Cooking Grates, Grill Racks. A 5 year warranty applies to: Radiant Trays, Radiant Tray Side Rails and the Drip Pan. 2 years full coverage warranty applies for parts and labour on the entire product.



- 1 Easy lifting hood
- 2 Intuitive lighting
- 3 Braising, baking and warming
- 4 Rotisserie
- 5 Charcoal grill and smoker
- 6 Double-sided cast stainless steel grates
- 7 Full surface searing
- 8 Grease Management System™
- 9 100% stainless steel
- 10 Easy cleaning
- 11 Lifetime warranty*

Grills

SERIES 7 GRILLS

DCS Series 7 Grills offer power, simplicity and control, giving you perfect results whether a premium steak or a delicate salmon fillet. Built from 304 grade stainless steel and delivering 25,000BTU of power, these grills combine premium styling with thoughtful design to deliver powerful performance and flexible grilling solutions.

Available in 30", 36" and 48" grills.

*Lifetime warranty on: Stainless Steel Grill Burners, Stainless Steel Grill Cover, Burner Box, Cooking Grates, Grill Racks. A 5 year warranty applies to: Radiant Trays, Radiant Tray Side Rails and the Drip Pan. 2 years full coverage warranty applies for parts and labour on the entire product.

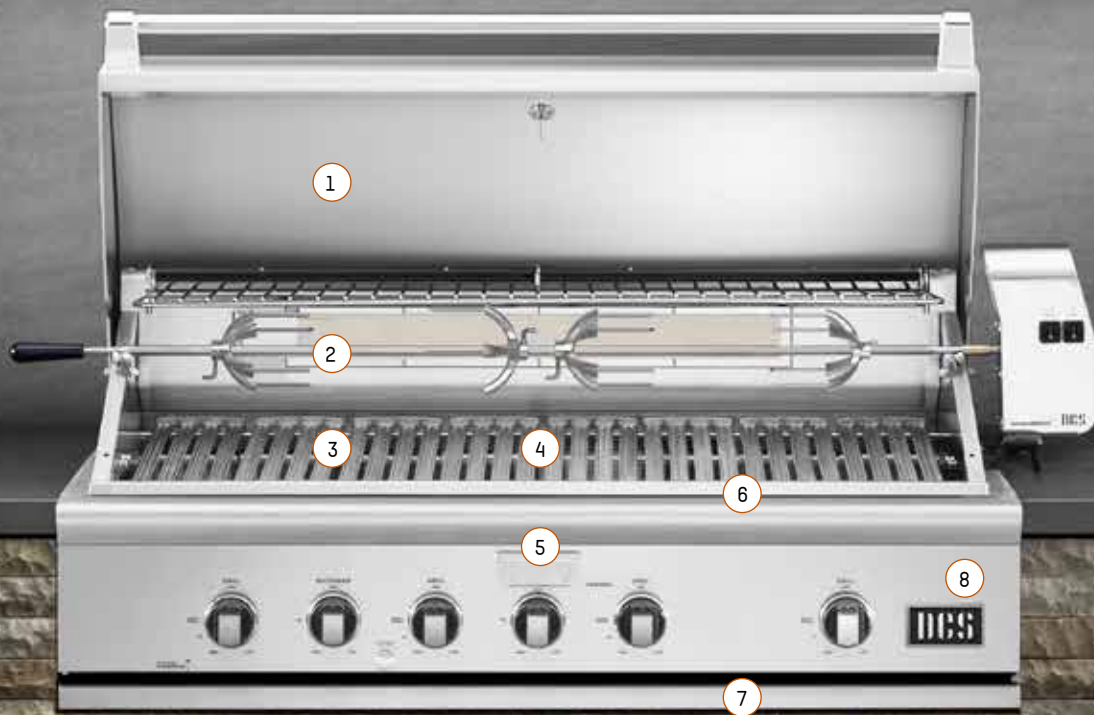

- ① 100% stainless steel
- ② Rotisserie
- ③ Double-sided cast stainless steel grates
- ④ Full surface searing
- ⑤ Smoker box
- ⑥ Grease Management System™
- ⑦ Easy cleaning
- ⑧ Lifetime warranty*

PROFESSIONAL RESULTS



Charcoal Grilling and Smoking

Smoking infuses flavor right through your food while charcoal grilling will give you a juicy result with a subtle barbecue flavor. Have it all with Gas, Charcoal and Smoker all-in-one in the Series 9 Grill. Enjoy smoky barbecue flavor with the ease of hot surface flame ignition. Grill directly on the cooking grate or add wood chips for more smoke. A W-shaped tray with adjustable vents helps the charcoal last longer.

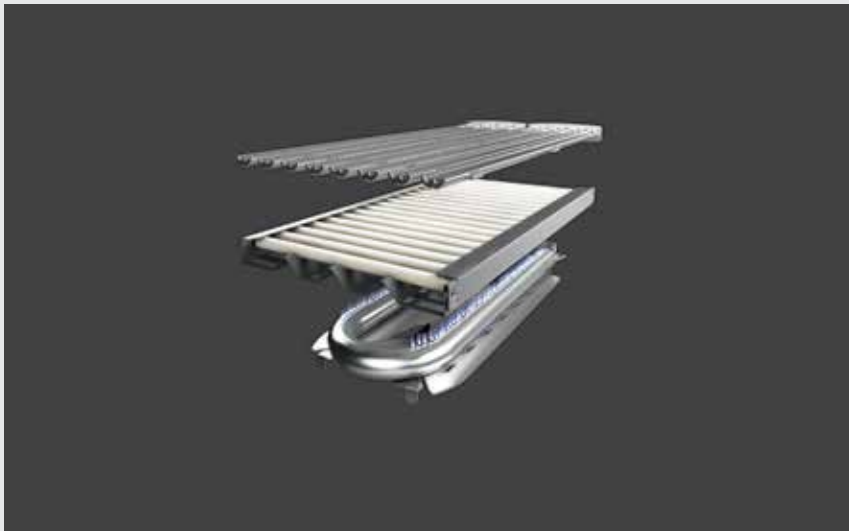

Searing

Perfectly seared meat achieves a crisp, well-browned exterior with a tender and juicy interior, whether fish, poultry, meat or vegetables. In both Series 7 and 9 Grills, DCS delivers exceptional searing across the full surface, with a powerful 25000BTU output rating from each burner. DCS's unique ceramic rod design evenly distributes this heat so there are no uneven hot spots or cold patches.



25K

BTU Burners

18K

BTU Searing Heat

50 lbs

Rotisserie
Capacity



Rotisserie

Rotisserie cooking delivers tender, juicy meat with a golden and crisp surface. An infrared rotisserie burner provides controlled searing heat up to 18,000BTU that can easily handle meat weighing up to 50lbs. Design details like the tuck-away rotisserie rod holder on Series 9 Grills deliver practicality with performance.



Braising, Baking and Warming

Good slow cooking gives you consistent, indirect heat over a long period of time, so breads rise evenly, and meat will pull off the bone.



The Series 9 Grill features controlled heat with a temperature gauge (ranging from 300°-1100°F), ideal for slow cooking to searing, direct and indirect heat. The two racks and one broiling pan can be easily moved to provide a secondary cooking space, giving you flexibility to cook almost anything.

Grills

BEAUTIFUL TO USE



Grease Management System™

Control of dripping grease is essential for delivering perfect results as well as easy cleaning. In both Series 7 and 9 Grills, avoid flare ups with DCS's patented Grease Management System™ which channels oil away from the flame giving you greater control and better cooked food.



Easy Lifting Hood

Grilling should be for everyone, so lightening the load of the solid stainless-steel hood makes the outdoor kitchen more accessible. With more space under the hood in for extra-large food items, the spring assisted hood in Series 9 Grills can be smoothly opened, using one hand, for better access and visibility when cooking. When opening the hood, its curvature directs heat and smoke away from you.



Easy Cleaning

To really enjoy your grill, simplified cleaning is essential. It ensures you are set up for perfect grilling and optimum flavor. Turn on the heat to sear for 15 minutes before you start cooking and all residue will be burnt off, leaving your cooking surface clean with almost no effort. DCS Series 7 and 9 Grills feature a removable drip pan, conveniently located in a slide-out tray to allow for easy cleaning.

12V

Hood Lighting



Intuitive Lighting

Good lighting helps you see what you are cooking, to achieve the perfect result. In the Series 9 Grill, dials glow white when the lights or grill are on, changing to orange when the knobs are turned on. See exactly what you're cooking, even at night with brilliant 12-volt hood lighting safely illuminating the whole grill.



Double-Sided Cast Stainless Steel Grates

Robust sear lines need a solid grate, but equally delicate foods like fish need a different surface for searing. Double-sided cast stainless steel grilling grates have a gentle radius for handling fragile foods. The other side is W-shaped for perfect sear lines while channelling oil away to the multi-position drip tray.



Grills

BUILT TO LAST



Lifetime Warranty

A premium grill should be with you for life. The warranty should support that. DCS Grills come with exceptional lifetime warranty on: Stainless Steel Grill Burners, Stainless Steel Grill Cover, Burner Box, Cooking Grates and Grill Racks. A 5 year warranty applies to: Radiant Trays, Radiant Tray Side Rails and the Drip Pan. 2 years full coverage warranty applies for parts and labour on the entire product.

100%

Stainless Steel



100% Stainless Steel

Real, solid, hardwearing and hand-finished materials are tangible elements of product quality. Built from heavy duty 304 stainless steel, inside and out, DCS Grills are built to handle anything mother nature can throw at them. All welded joints are hand-finished to deliver a premium finish and quality assurance.



Grills

DESIGNED TO FIT

Cooking attachments to match your grill

Complement your outdoor lifestyle with grills and accessories that are designed to match and work together intuitively. Both Series 9 and Series 7 ranges have cooking attachments with a matching look to complete your outdoor kitchen. Storage, refrigeration and heating options give you a full outdoor kitchen suite.



Unified Operation

The matching look of DCS Series 9 products is amplified by connectivity between the products, so all dials light up simultaneously.



Built-in and Freestanding Options

All grill heads in both Series 9 and Series 7 ranges are available for both built-in and freestanding arrangements. Carts for freestanding options are purchased separately. See storage and carts section for cart options.

Series 9 Grills



48" Series 9 Grill

BEI-48RC

71437 / 71438

H27 1/4" x W47 15/16" x D26 7/8"

H10 1/8" x W45 3/4" x D22 3/4"



36" Series 9 Grill

BEI-36RC

71439 / 71440

H27 1/4" x W35 15/16" x D26 7/8"

H10 1/8" x W34 1/2" x D22 3/4"

TYPE OF APPLIANCE

PRODUCT

SKU (NATURAL / LP)

Product Dimensions

Cut-out Dimensions (proud installation)

All grills can be built-in or freestanding.
See carts section for freestanding options.

Series 7 Grills

TYPE OF APPLIANCE

PRODUCT

SKU (NATURAL / LP)

Product Dimensions

Cut-out Dimensions (proud installation)



48" Series 7 Grill

BHI-48R

71444 / 71445

H24 1/4" x W47 7/8" x D26 5/8"

H10 1/8" x W45 3/4" x D22 3/4"



48" Series 7 Grill with Integrated Side Burners

BHI-48RS

71446 / 71447

H24 1/4" x W47 7/8" x D26 5/8"

H10 1/8" x W45 3/4" x D22 3/4"



36" Series 7 Grill

BHI-36R

71448 / 71449

H24 1/4" x W35 7/8" x D26 5/8"

H10 1/8" x W34 1/2" x D22 3/4"



30" Series 7 Grill

BHI-30R

71450 / 71451

H24 1/4" x W30" x D26 5/8"

H10 1/8" x W28 1/2" x D22 3/4"



30" Series 7 Grill, Non Rotis

BGC30-BQ

71452 / 71453

H24 1/4" x W30" x D26 5/8"

H10 1/8" x W28 1/2" x D22 3/4"



COOKING ATTACHMENTS

Complete your ultimate outdoor kitchen with cooking attachments to complement your grill. By selecting products specifically designed for unique outdoor cooking purposes you can tailor your setup to suit how you entertain.

Power Burner — Perfect for deep frying, wok cooking and rapid boiling. All Grill — Add grilling space to your outdoor setup. Griddle — Get a flat surface perfect for searing.

Cooking Attachments

Series 9 and Series 7 ranges each have a matching look and feel with the Series 9 products amplified by connectivity between the products, so all dials light up simultaneously.

- ① 24" Power Burner
- ② 30" Griddle
- ③ 30" Griddle/Double Side Burner
- ④ 14" Double Side Burner
- ⑤ 30" All Grill





3

4

5

PROFESSIONAL RESULTS



Power Burner: Power with control

The Power Burner delivers powerful heat through a high pressure burner, perfect for large steam pots. Precise temperature control from 70,000 to 1,300BTU enables a rapid boil down to a gentle simmer.



Griddle: Cooking versatility

Bring more cooking options to your outdoor kitchen with quick cooking on the griddle. Cook different foods at the same time with precision thermostatic control, separate temperature zones and even heat distribution.



All Grill: High-powered searing in low-profile format

Cook it your way with a variety of flexible cooking methods provided by DCS cooking attachments.

BEAUTIFUL TO USE



Power Burner: Smart grate design

The Power Burner grates are specially designed to provide stability for pots and woks of all sizes, reducing the need to adjust them. Grates can also be separated into two parts to make cleaning easy.



Griddle: Safe and convenient

Clean up is simple due to the griddle's removable slide out drip tray. For your safety, a flame failure device cuts the gas if a burner goes out.



Information at a glance

Illuminated dials immediately and intuitively tell you at a glance if the product is on. Get cooking quickly with a fast, weather resistant ignition system that works every time.

BUILT TO LAST



Power Burner: Cast brass burner
Made from durable, cast brass, the burner is designed to withstand high temperatures and all types of weather.



Side Burner: Robust construction
Constructed from 304 grade stainless steel designed to withstand all types of weather conditions, with a quality weld and finish, DCS Side Burners are built to last.



Griddle: Heavy duty build
Designed to withstand high temperatures, the DCS Griddle plate is made from durable, 8mm thick 304 stainless steel.

DESIGNED TO FIT



Designed to match

With a matching look across all DCS Series 9 products, you can create a stylish, cohesive design for your outdoor kitchen. Seamless installation and interconnectivity between products allows for unified operation, from ignition to dial illumination.

Series 9 Cooking Attachments

TYPE OF APPLIANCE

PRODUCT

SKU (NATURAL / LP)

Product Dimensions

Cut-out Dimensions (proud installation)



24" Series 9 Power Burner

PBEI-24

71466 / 71467

H10 1/2" x W24" x D26 7/8"

H10 1/8" x W22 1/2" x D22 3/4"



30" Series 9 All Grill

BEI-30AG

71441 / 71442

H10 1/2" x W30" x D26 7/8"

H10 1/8" x W28 1/2" x D22 3/4"



30" Series 9 Griddle

GDEI-30

71464 / 71465

H10 1/2" x W30" x D26 7/8"

H10 1/8" x W28 1/2" x D22 3/4"



30" Series 9 Double Side Burner/Griddle

GDSBEI-302

71469 / 71470

H10 1/2" x W30" x D26 7/8"

H10 1/8" x W28 1/2" x D22 3/4"



14" Series 9 Double Side Burner

SBEI-142

71471 / 71472

H10 3/8" x W14 1/16" x D26 7/8"

H10 1/8" x W12 1/8" x D22 3/4"

Series 7 Cooking Attachments

TYPE OF APPLIANCE

PRODUCT

SKU (NATURAL / LP)

Product Dimensions

Cut-out Dimensions (proud installation)



30" Series 7 All Grill

BFGC-30G

71454 / 71455

H10½" x W30" x D26⅝"

H10⅙" x W28½" x D22¾"



30" Series 7 Double Side Burner/Griddle

BFGC-30BGD

71474 / 71475

H10½" x W30" x D26⅝"

H10⅙" x W28½" x D22¾"



14" Series 7 Double Side Burner

BGC132-BI

71476 / 71477

H10⅝" x W14⅜" x D26⅝"

H10⅙" x W12⅙" x D22¾"



OUTDOOR STORAGE AND CARTS

Hidden ingenuity makes the DCS storage systems essential to a well-designed outdoor kitchen. Adding convenience by reducing the need to go inside for cups or cutlery, spices or charcoal, you can store all your cookout essentials close at hand for both built-in and freestanding installs.

Designed for superior flush or proud installs. With no curved corners, stone stacks cleanly against the square edge DCS doors and drawers, saving your contractor time and giving a better finish. Double walls give strength and insulation properties, and coupled with plugs in large drawers, the drawers can be filled with ice. A range of doors and drawers as well as specialized functionality like trash bins or a completely sealed dry pantry allow you to build out the ideal storage solution for your needs.

Access Drawers and Warming Drawer

TYPE OF APPLIANCE

PRODUCT

SKU

Product Dimensions

Cut-out Dimensions (proud installation)

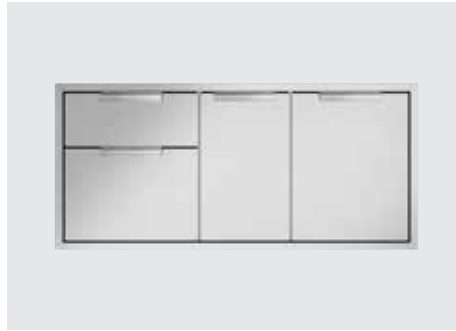

48" Access Drawers, Built-In

ADR2-48

71481

H21 $\frac{7}{8}$ " x W47 $\frac{15}{16}$ " x D25 $\frac{1}{2}$ "

H20" x W46" x D24"

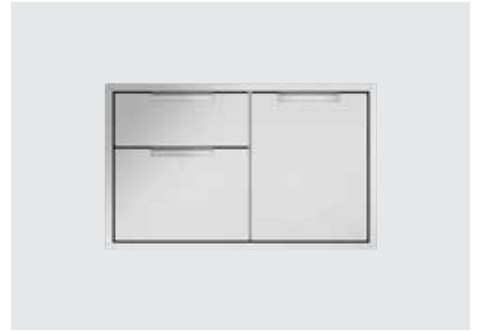

36" Access Drawers, Built-In

ADR2-36

71482

H21 $\frac{7}{8}$ " x W35 $\frac{15}{16}$ " x D25 $\frac{1}{2}$ "

H20" x W34" x D24"

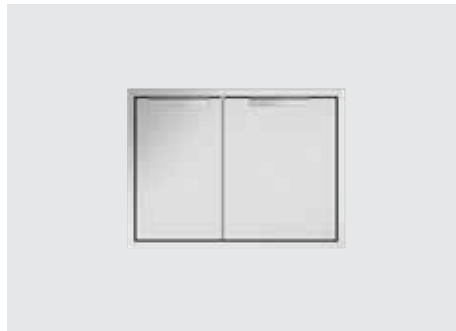

30" Access Drawers, Built-In

ADR2-30

71483

H21 $\frac{7}{8}$ " x W30" x D25 $\frac{1}{2}$ "

H20" x W28" x D24"



24" Access Drawers, Built-In

ADR2-24

71484

H21 $\frac{7}{8}$ " x W24" x D25 $\frac{1}{2}$ "

H20" x W22" x D24"



30" Outdoor Warming Drawer

WD1-30-SSOD

71507

H16" x W30" x D26 $\frac{1}{8}$ "

H14 $\frac{7}{16}$ " x W28 $\frac{3}{8}$ " x D24 $\frac{3}{16}$ "

Access Doors and Dry Pantry

TYPE OF APPLIANCE

PRODUCT

SKU

Product Dimensions

Cut-out Dimensions (proud installation)

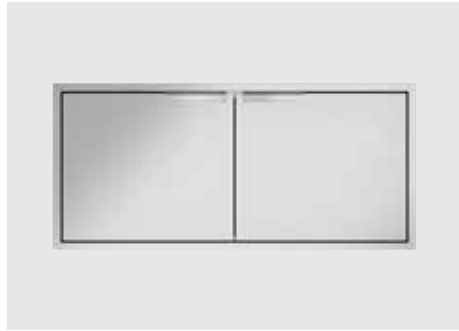

48" Access Doors, Built-In

ADN1-20X48

71488

H21⁷/₈" x W47¹⁵/₁₆" x D6¹/₄"

H20" x W46"

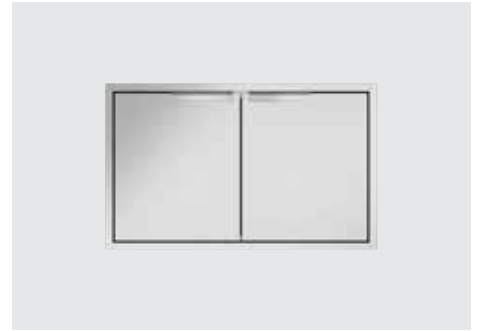

36" Access Doors, Built-In

ADN1-20X36

71489

H21⁷/₈" x W35¹⁵/₁₆" x D6¹/₄"

H20" x W34"

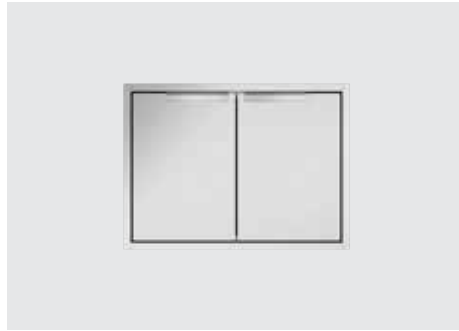

30" Access Doors, Built-In

ADN1-20X30

71490

H21⁷/₈" x W30" x D6¹/₄"

H20" x W28"

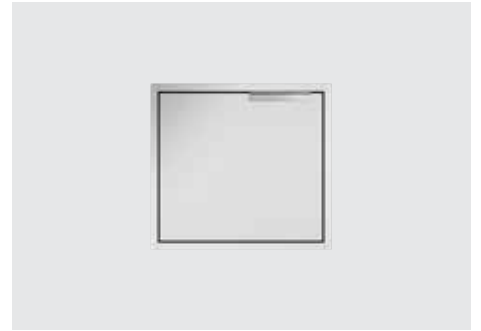

24" Access Doors, Built-In

ADN1-20X24

71491

H21⁷/₈" x W24" x D6¹/₄"

H20" x W22"

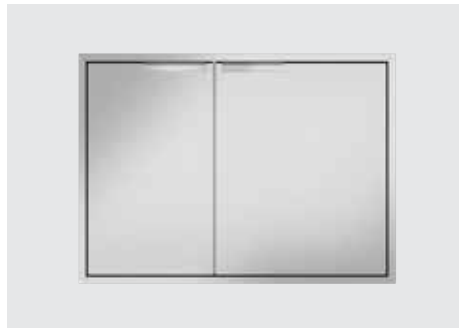

42" Dry Pantry

DP1-42

71493

H30¹/₂" x W42" x D25¹/₁₆"

H29³/₁₆" x W40⁷/₁₆" x D24¹/₁₆"

Tower Drawers and Trash/Recycle Bin

TYPE OF APPLIANCE

PRODUCT

SKU

Product Dimensions

Cut-out Dimensions (proud installation)

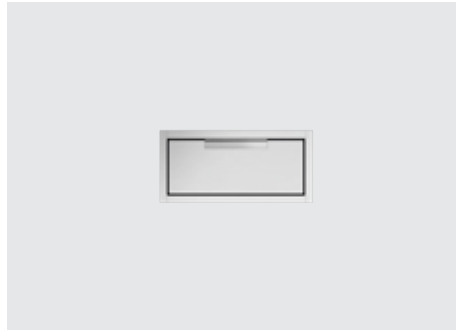

20" Tower Drawer, Single

TDS1-20

71496

H9 ⁵/₈" x W20 ⁵/₁₆" x D25"

H8 ³/₁₆" x W18 ⁷/₈" x D24"

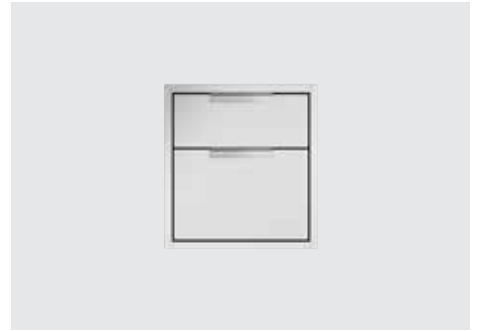

20" Tower Drawer, Double

TDD1-20

71495

H21 ¹/₈" x W20 ⁵/₁₆" x D25"

H20 ¹/₁₆" x W18 ⁷/₈" x D24"



20" Tower Drawer, Triple

TDT1-20

71494

H29 ¹/₈" x W20 ⁵/₁₆" x D25"

H28" x W18 ⁷/₈" x D24"



20" Double Trash/Recycle Bin

TB1-20

71497

H29 ¹/₈" x W20 ⁵/₁₆" x D25"

H28" x W18 ⁷/₈" x D24"

TYPE OF APPLIANCE
PRODUCT
SKU
Product Dimensions
Cut-out Dimensions (proud installation)



6" Countertop Storage - 48" Series 9 Grill

ASE6-48
71405
H11 ¹³ / ₆₄ " x W7 ²³ / ₃₂ " x D26 ⁷ / ₈ "
H10 ¹ / ₈ " x W52 ¹ / ₈ " x D22 ³ / ₄ "



6" Countertop Storage - 36" Series 9 Grill

ASE6-36
71332
H11 ¹³ / ₆₄ " x W7 ¹¹ / ₃₂ " x D26 ⁷ / ₈ "
H10 ¹ / ₈ " x W40 ¹ / ₂ " x D22 ³ / ₄ "



6" Countertop Storage - 48" Series 7 Grill

ASH6-48
71406
H11 ¹³ / ₆₄ " x W7 ⁴⁹ / ₆₄ " x D26 ⁴¹ / ₆₄ "
H10 ¹ / ₈ " x W52 ¹ / ₈ " x D22 ³ / ₄ "



6" Countertop Storage - 36" Series 7 Grill

ASH6-36
71333
H11 ¹³ / ₆₄ " x W7 ³ / ₈ " x D26 ⁴¹ / ₆₄ "
H10 ¹ / ₈ " x W40 ¹ / ₂ " x D22 ³ / ₄ "

Carts

TYPE OF APPLIANCE

PRODUCT

SKU

Product Dimensions



30" CAD Cart

CAD1-30E

71525

H35½" x W30" x D25½"



36" Grill CAD Cart

CAD1-36E

71526

H35½" x W35¹/₁₆" x D25½"

All carts are compatible with Series 7 and Series 9.



48" Grill CAD Cart

CAD1-48E

71527

H35½" x W47¹/₁₆" x D25½"



30" CSS Cart with Single Door*

CSS-30

71320

H35¾" x W30" x D25½"

*compatible with 30" grill head only





REFRIGERATION

Make your outdoor grilling space a complete kitchen by adding refrigeration. Meat, sauces or drinks are kept close at hand for cooking and give you true convenience. With door and drawer options available with secure external lock, there are styles to suit your kitchen.

Single or dual-tap beer dispensers are great for a crowd, a purpose-designed ice maker and the beverage chiller (also a sink, faucet not included) are essential for sodas and cocktail making.

Outdoor Refrigerators, Beer Dispensers and Ice Maker

TYPE OF APPLIANCE

PRODUCT

SKU

Product Dimensions

Cut-out Dimensions (proud installation)



24" Outdoor Refrigerator

RF24LE3 (Shown), RF24RE3

71514 / 71513

H33 3/4" - 34 3/4" x W23 7/8" x D23 23/32"

H34 1/2" x W24"



24" Double Refrigerator Drawers

RF24DE4

71512

H33 3/4" - 34 3/4" x W23 7/8" x D23 23/32"

H34 1/2" x W24"



24" Outdoor Beer Dispenser — Single Tap

RF24TL1 (Shown), RF24TR1

71518 / 71517

H33 3/4" - 34 3/4" x W23 7/8" x D23 23/32"

H34 1/2" x W24"



24" Outdoor Beer Dispenser — Dual Tap

RF24BTL1 (Shown), RF24BTR1

71516 / 71515

H33 3/4" - 34 3/4" x W23 7/8" x D23 23/32"

H34 1/2" x W24"



15" Outdoor Clear Ice Maker

RF15IL1 (Shown), RF15IR1

71510 / 71509

H34 1/4" x W15" x D21 1/2"

H34 1/2" x W15"

Beverage Chiller and Accessory



Series 9 Beverage Chiller Bottle Holder Accessory Front

BCI-25AC
 71504
 H10 3/8" x W25 1/16" x D6 5/8"



Series 7 Beverage Chiller Bottle Holder Accessory Front

BC-BOTTLE-25
 71505
 H10 3/8" x W25 1/16" x D6 5/8"

TYPE OF APPLIANCE

PRODUCT

SKU

Product Dimensions

Cut-out Dimensions (proud installation)



25" Beverage Chiller/Sink*

BC25
 71034
 H12 1/16" x W26 3/8" x D21 13/16"
 W24 3/16" x D21 1/16"

*Faucet not included

ACCESSORIES AND HEATING

Whether you need an insulating jacket for a built-in install or want to add cooking options to your grill, we have all the accessories, shelves and kits to complete your outdoor kitchen. A patio heater extends the usability of your outdoor kitchen.

Installation Accessories: Insulated Jackets

TYPE OF APPLIANCE

PRODUCT

SKU

Product Dimensions

Cut-out Dimensions (proud installation)



24" Insulated Jacket

BGA24-IJS

71426

H11 $\frac{1}{8}$ " x W28 $\frac{5}{8}$ " x D23 $\frac{3}{4}$ "

H11 $\frac{1}{8}$ " x W28 $\frac{7}{8}$ " x D23 $\frac{3}{4}$ "



30" Insulated Jacket

BGB30-IJS

70859

H11 $\frac{1}{8}$ " x W34 $\frac{5}{8}$ " x D23 $\frac{3}{4}$ "

H11 $\frac{1}{8}$ " x W34 $\frac{7}{8}$ " x D23 $\frac{3}{4}$ "



36" Insulated Jacket

BGA36-IJS

70167

H11 $\frac{1}{8}$ " x W40 $\frac{3}{8}$ " x D23 $\frac{3}{4}$ "

H11 $\frac{1}{8}$ " x W40 $\frac{1}{2}$ " x D23 $\frac{3}{4}$ "



42" Insulated Jacket

BGA42-IJS

71335

H11 $\frac{1}{8}$ " x W47 $\frac{3}{4}$ " x D23 $\frac{3}{4}$ "

H11 $\frac{1}{8}$ " x W48" x D23 $\frac{3}{4}$ "



48" Insulated Jacket

BGA48-IJS

70172

H11 $\frac{1}{8}$ " x W51 $\frac{1}{2}$ " x D23 $\frac{3}{4}$ "

H11 $\frac{1}{8}$ " x W51 $\frac{5}{8}$ " x D23 $\frac{3}{4}$ "



54" Insulated Jacket

BGA54-IJS

71334

H11 $\frac{1}{8}$ " x W59 $\frac{3}{4}$ " x D23 $\frac{3}{4}$ "

H11 $\frac{1}{8}$ " x W60" x D23 $\frac{3}{4}$ "

TYPE OF ACCESSORY

PRODUCT

SKU

DESCRIPTION



Grill Surface Hybrid Infrared Burner

BGC-IR

71409

The DCS Infrared Hybrid Burner delivers rapid heat-up with precise control of the heat turn-down, allowing great flexibility with what foods you are able to cook on the grill. The infrared burner also provides traditional sear lines on food, for the authentic grill experience.



Grill Surface Griddle Plate

BGC-GP

71410

Made of commercial quality plated stainless steel that insures a level cooking surface and even heat distribution, the DCS Grill Griddle Plate allows you to cook delicate items on your Grill with ease.



CAD Cart Side Shelf Kit

CAD1-SK

71189

Attached to your Freestanding Cart, 24" heavy-duty, stainless steel side shelf kits offer a sturdy expansive workspace that folds down when not in use.



CSS Grill Cart Side Shelf

CSS-SK

71323

Attached to your Freestanding Cart, 20" heavy-duty stainless steel side shelf kits offer a sturdy expansive workspace that folds down when not in use.



Built-In Patio Heater

DRH-48N

71531

H10 1/4" x W48" x D7 3/4"



BUILD YOUR ULTIMATE OUTDOOR KITCHEN

The grill is only part of the ultimate outdoor kitchen setup. The space you have, how you want to entertain, and your expectations around performance will all play a role in how you make your outdoors outstanding.

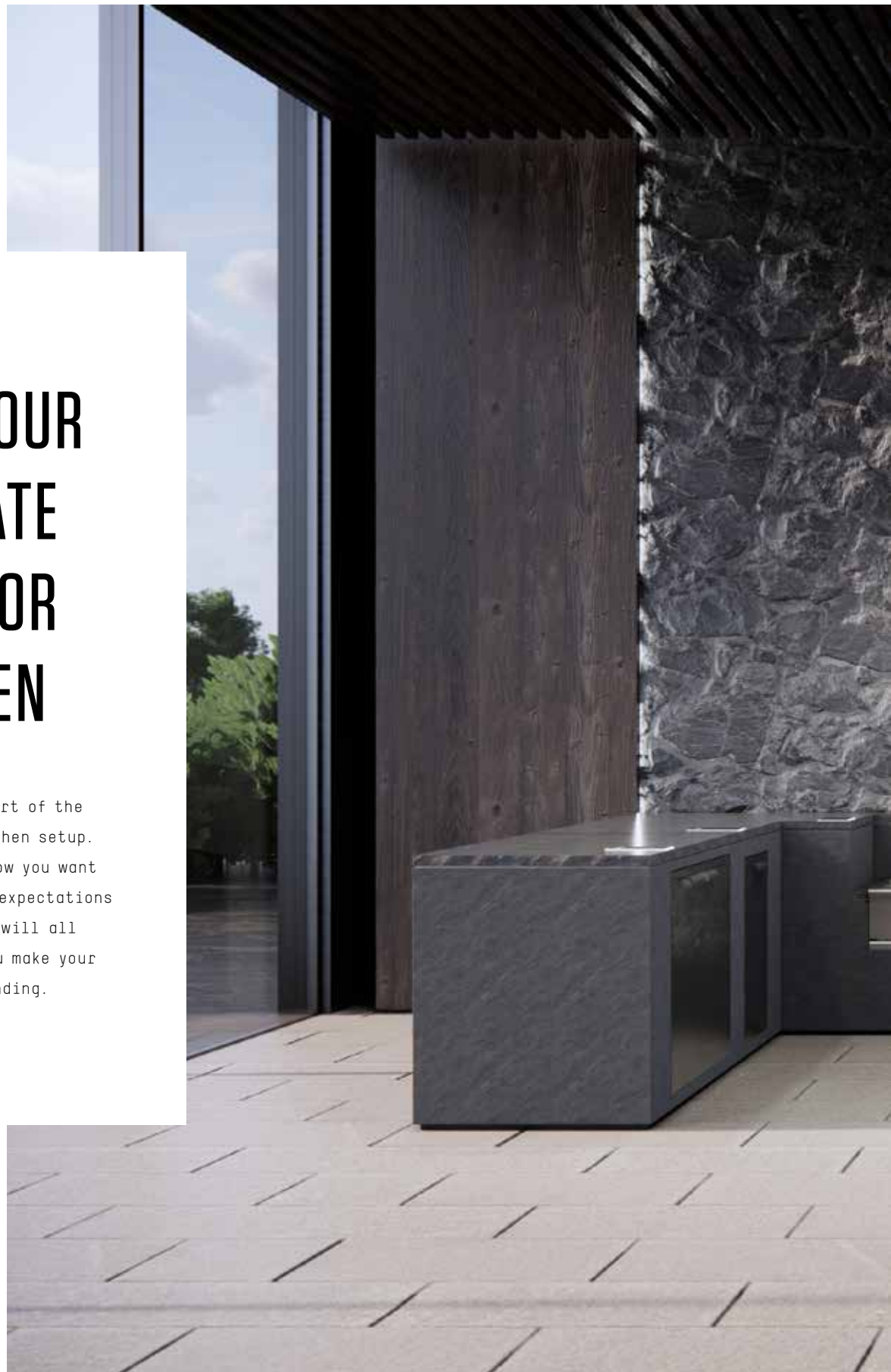



Configuration

LARGE PACKAGE



Professional results

The large kitchen package is the ultimate solution for the experimental mavericks among us. Create your ideal outdoor lifestyle with grills and complementary products that are designed to match and work together as one.



Designed to fit

From ice makers to power burners, you can customize your outdoor kitchen to suit your needs. Experience equipment that beautifully balances design and functionality allowing you to always be in control.

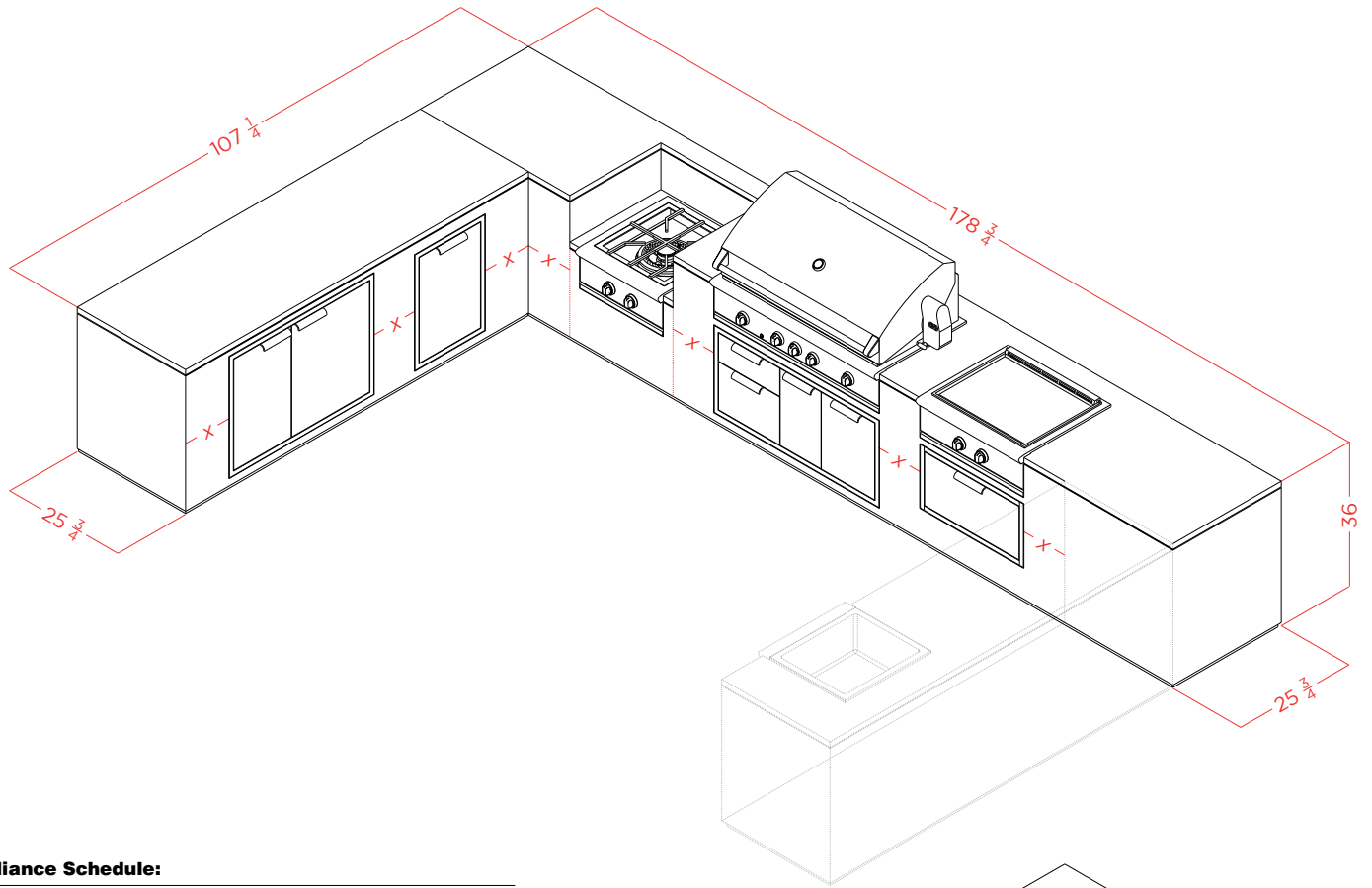

Appliance Schedule:

48" Series 9 Grill, Natural Gas	BE1-48RC-N
48" Access Drawers	ADR2-48
24" Series 9 Power Burner, Natural Gas	PBE1-24-N
30" Series 9 Griddle, Natural Gas	GDE1-30-N
42" Dry Pantry	DP1-42
20" Double Trash/Recycle Bin	TB1-20
24" Refrigerator	RF24LE3
15" Ice Maker	RF15IR1
25" Beverage Chiller + Bottle Holder	BC1-25AC
20" Tower Drawer Single	TDS1-20

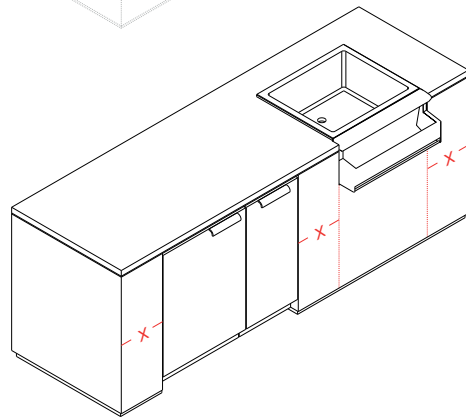

Product Spacing (x)

IDEAL	12"
MINIMUM	8"

Configuration

MEDIUM PACKAGE

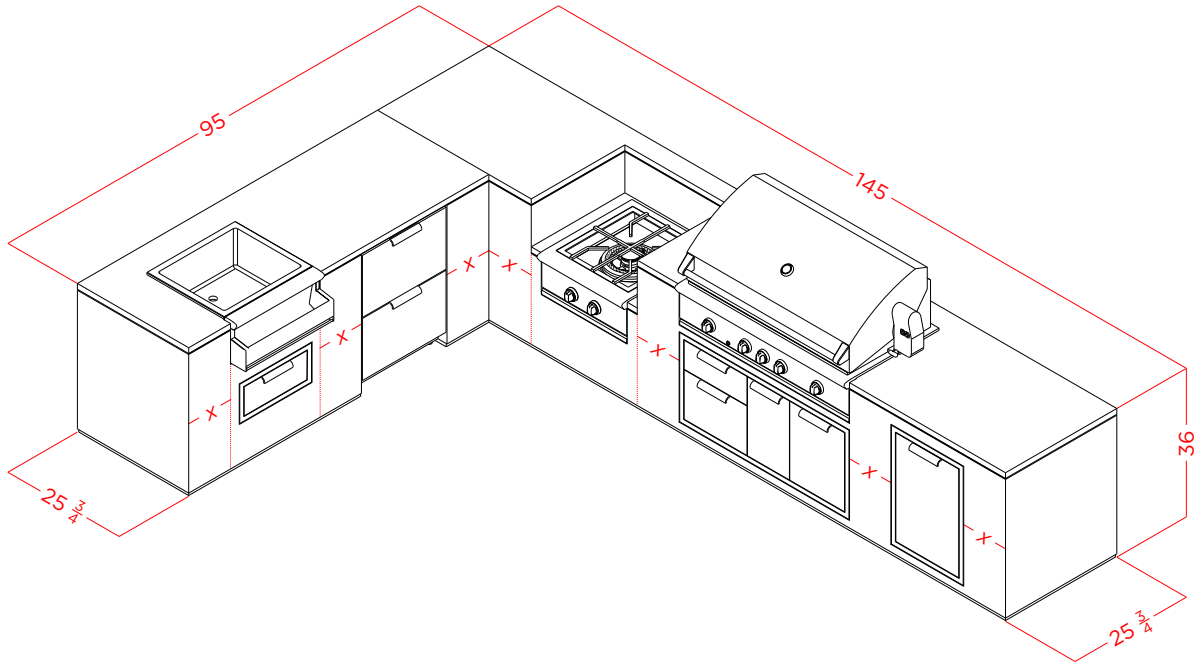

Appliance Schedule:

48" Series 9 Grill, Natural Gas	BE1-48RC-N
48" Access Drawers	ADR2-48
24" Series 9 Power Burner, Natural Gas	PBE1-24-N
20" Double Trash/Recycle Bin	TB1-20
24" Double Refrigerator Drawers	RF24DE3
25" Beverage Chiller + Bottle Holder	BC1-25AC
20" Tower Drawer Single	TDS1-22



Product Spacing (x)

IDEAL	12"
MINIMUM	8"

Configuration

SMALL PACKAGE 01

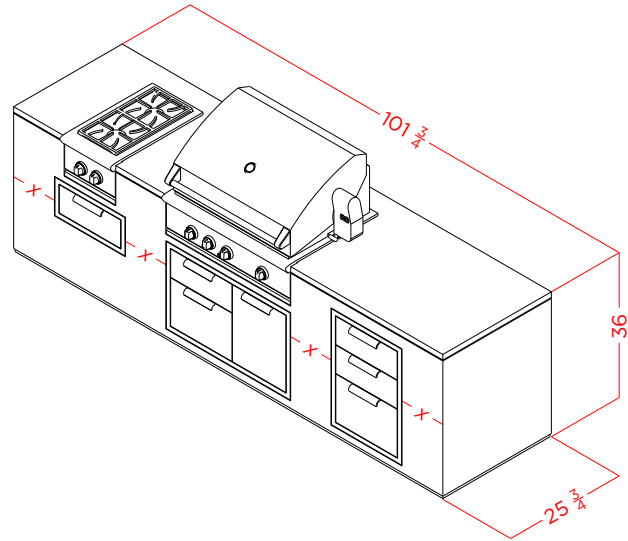

Appliance Schedule:

36" Series 9 Grill, Natural Gas	BE1-36RC-N
36" Access Drawers	ADR2-36
14" Series 9 Double Side Burner, Natural Gas	SBE1-142-N
20" Tower Drawer Single	TDS1-20
20" Tower Drawer Triple	TDT1-20



Product Spacing (x)

IDEAL	12"
MINIMUM	8"

Configuration

SMALL PACKAGE 02

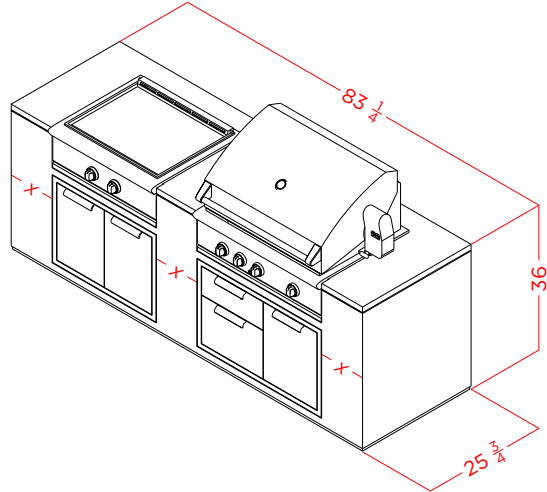

Appliance Schedule:

36" Series 9 Grill, Natural Gas	BE1-36RC-N
36" Access Drawers	ADR2-36
30" Series 9 Griddle, Natural Gas	GDE1-30-N
30" Access Doors	ADN1-20X30



Product Spacing (x)

IDEAL	12"
MINIMUM	8"

Configuration

COMPACT PACKAGE

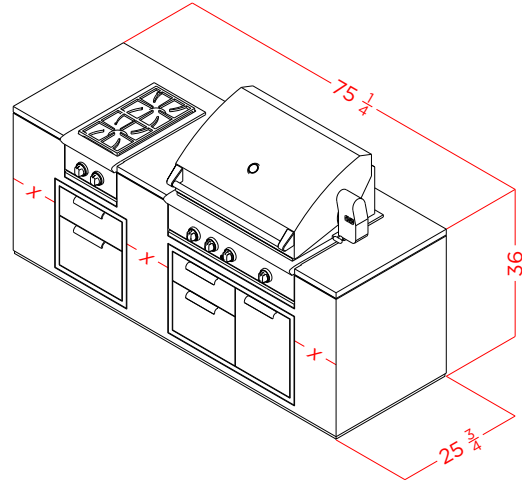

Appliance Schedule:

36" Series 9 Grill, Natural Gas	BE1-36RC-N
36" Access Drawers	ADR2-36
14" Series 9 Double Side Burner, Natural Gas	SBE1-142-N
20" Tower Drawer Double	TDD1-20



Product Spacing (x)

IDEAL	12"
MINIMUM	8"

Outdoor Cutouts - Non-combustible Surrounds

Note: All cut-out dimensions are shown in inches and reflect a proud installation.

Countertops that overhang the cabinet fronts require notches to accommodate the front panel

- 14" BCG131
- 14" BCG132
- 14" SBE1-14
- 24" PBE1-24
- 30" BFGC30G
- 30" BFGC30BGD
- 30" BGC30-BQ
- 30" BHI-30R
- 30" BE1-30
- 30" GDSBE1-30
- 30" GDE1-30
- 36" BE1-36RC
- 36" BHI-36R
- 48" BE1-48RC
- 48" BHI-48RS
- 48" BHI-48R

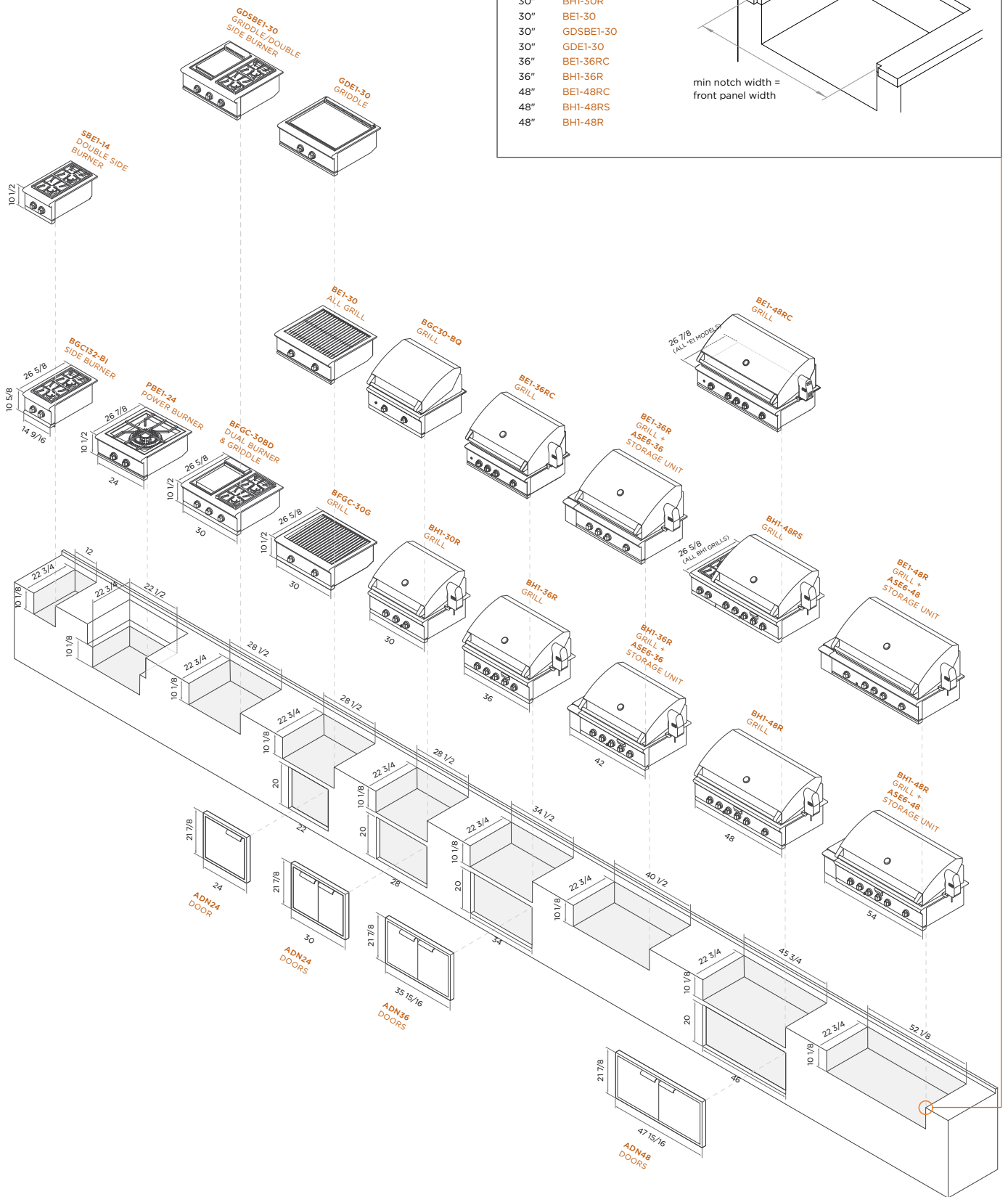
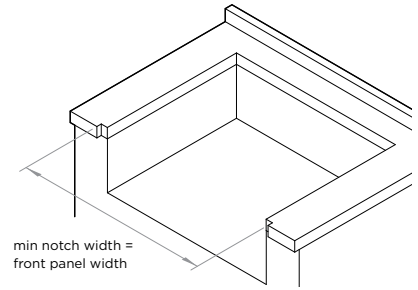

Outdoor Cutouts - Combustible Surrounds

Note: All cut-out dimensions are shown in inches and reflect a proud installation.

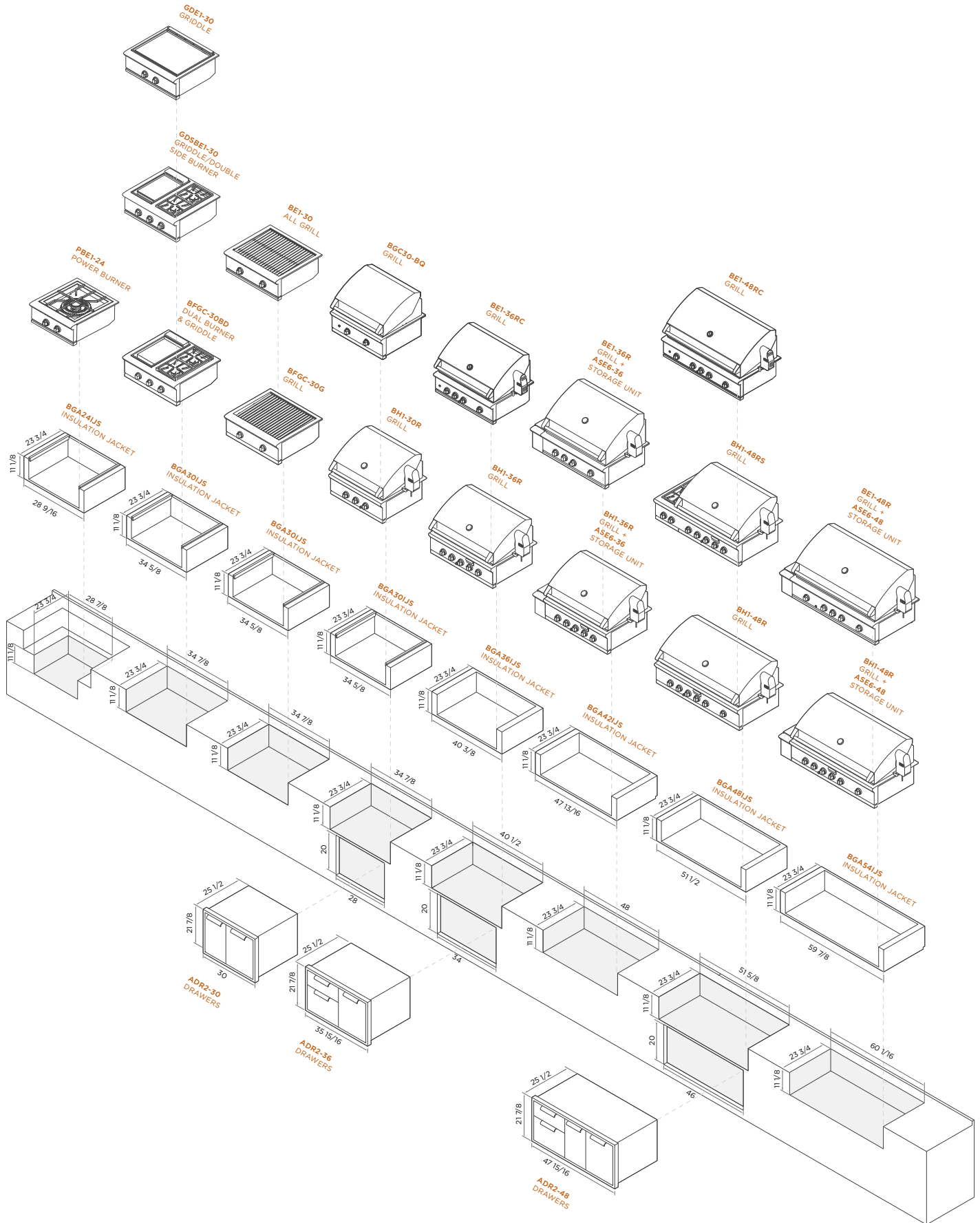

Outdoor Cutouts - Storage Accessories

Note: All cut-out dimensions are shown in inches and reflect a proud installation.

Countertops that overhang the cabinet fronts require notches to accommodate the front panel

25 1/16" BC-BOTTLEAC-25/BC25
25 1/16" BC1-25AC/BC25

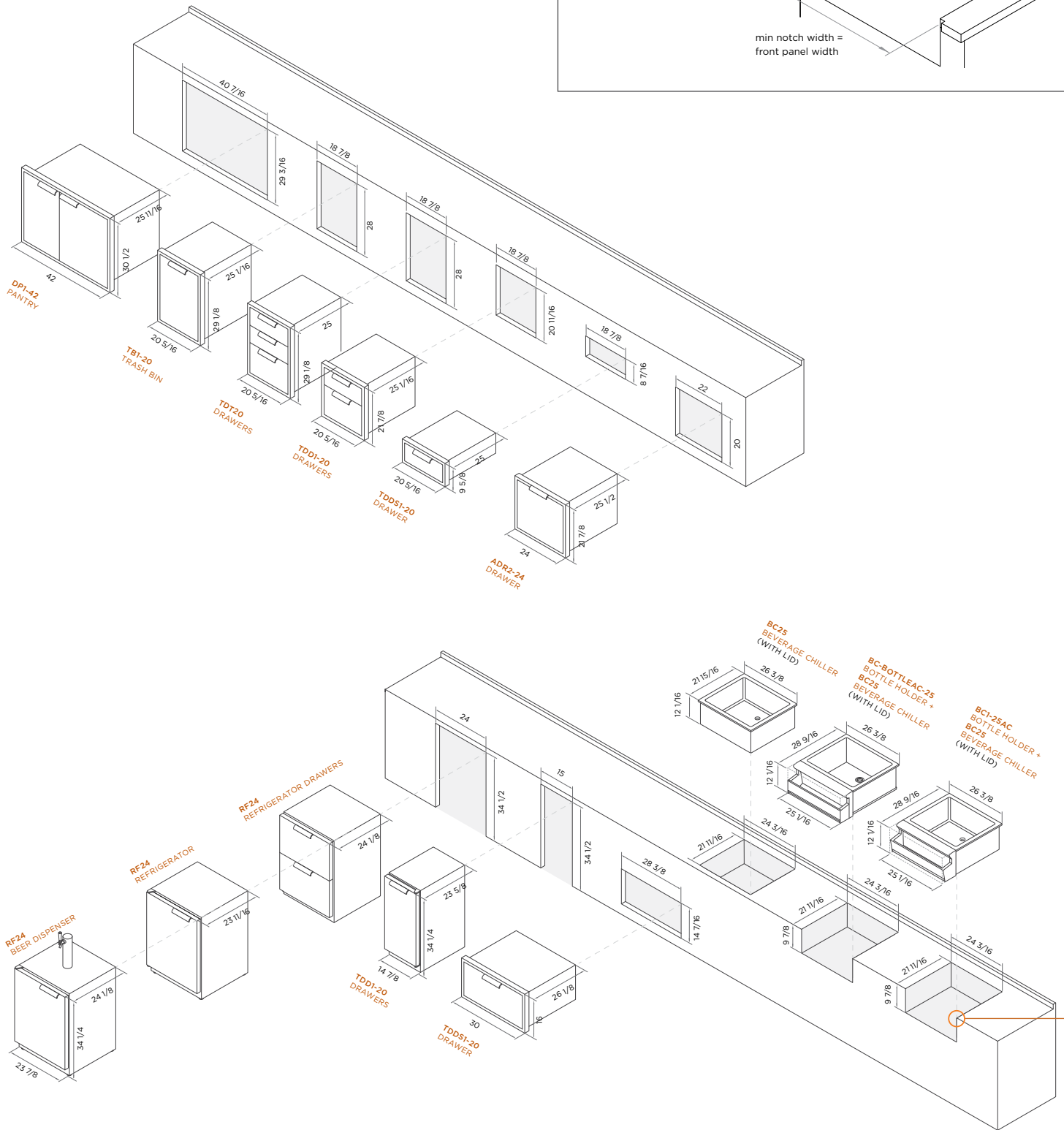
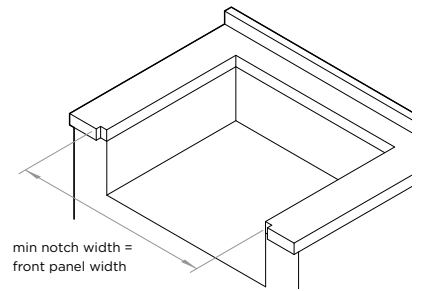

This document should not be used as installation guidance for any product. Further information is required to safely and correctly install the products featured here. Specific installation guidance will be available with the product on delivery and on our website fisherpaykel.com



Customer Care

A Peace-of-mind Purchase

Call 24 hours a Day, 7 Days a Week

DCS Appliances has a 24-hour toll-free service that allows you to speak directly to a Customer Care Representative about any questions you might have regarding your DCS products. Our Customer Care Representatives can offer advice on which appliance will best suit your needs and provide extensive information regarding on how to use your current Fisher & Paykel and DCS products. We can also advise on installations, schedule service with our Factory Service team (if available) and tell you where your nearest Authorized Service Center can be found. Nobody is better qualified to install, service, and repair your Fisher & Paykel and DCS household appliances than our network of specifically trained service technicians.

Email us at customercare@fisherpaykel.com or call 24/7

1 - 888 - 936 - 7872

Factory Service in Your Area

Assistance & Complete Servicing

Factory Service is available in most metropolitan areas. Please visit dcsappliances.com/customersupport or call 1-888-936-7872 for current coverage. We will recommend one of our Authorized Service Companies for areas where Factory Service is not available.

Easy Online Scheduling

- Go to our website at dcsappliances.com
- Click "Customer Care" from the top menu
- Click "Service My Product" from the options available
- Enter your zip code on the right side of the page

Factory Service Advantages

- 12 months part and labor warranty on all repairs
- Full stock of parts on vehicles
- Expert assistance on DCS and Fisher & Paykel products
- Before and after sales service
- Product education at the completion of service
- 24/7 booking service

DCS