

MODEL SPECIFICATIONS (Cont.)

Height		Width			Depth	
Floor to top (with oven)		Floor to top of shelf (C)	Left to right		Front to back	
Open (A)	Closed (B)		Post base (D)	Shelf to shelf (E)	Post base (F)	Maximum outer (G)
58 1/2"	48"	36 1/2"	26"	51"	20 1/4"	24 3/4"

Table 2 - Post Patio Mount Grill Dimensions

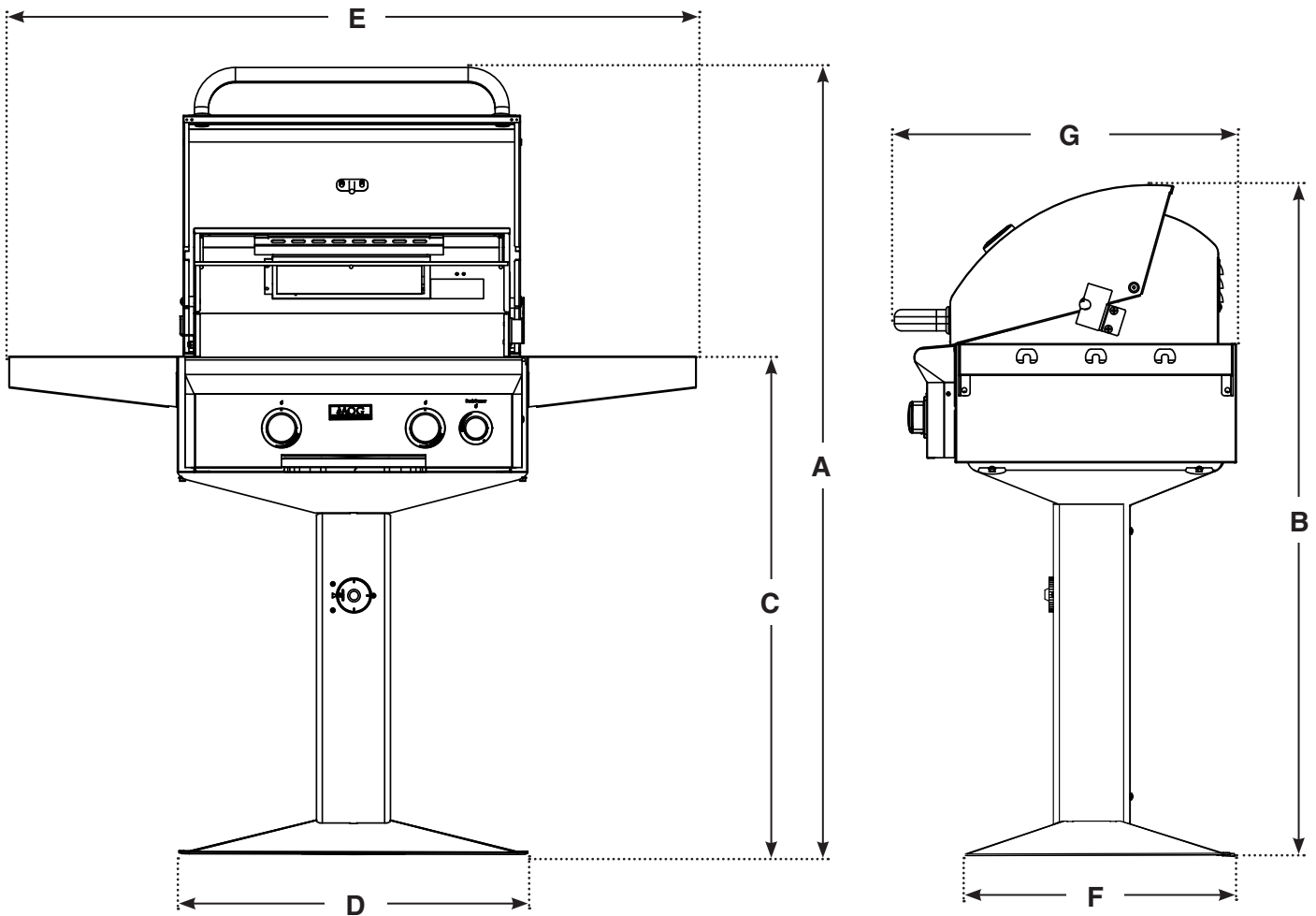

Fig. 12-1