

KESNOS

Commercial Dehumidifier

Please read the manual carefully
before using the unit

DP902A

USER MANUAL

BEFORE FIRST USE:

To prevent any internal damage, it is very important to keep the product upright throughout their journey. Please leave it standing upright and outside the box for **24 HOURS** before plugging it in.

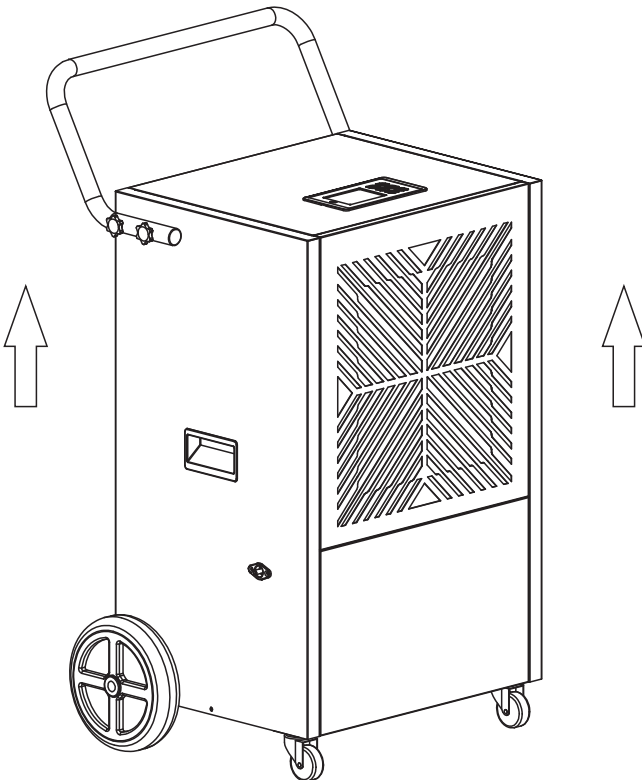

FOR CUSTOMERS

Thank you for purchasing our dehumidifier.

Kesnos wishes that our products and services can bring convenience to your work and life. We highly recommend that you keep the manual for reference if you encounter unexpected events using the unit. Please read the manual carefully to ensure the proper use of the dehumidifier.

Our company's dehumidifiers are widely used in family bedrooms, bathrooms, basements, offices, storage rooms, etc.

The dehumidifier from **Kesnos** operates quickly and efficiently to reduce room's humidity and bring you a healthy and comfortable life.

To Access Customer Support Faster

If there is any problem of the product, please contact Kesnos Customer Service at support@kesnos.com with your Purchase Order ID to help us address the problem faster.

TABLE OF CONTENTS

Safety Instructions01

Product Diagram02

Operation Instructions03

Drainage08

Maintenance10

Troubleshooting11

Error Codes12

Special Notes13

Specifications14

Warranty & Contact Us15

Safety Instructions

For your safety, please read and keep the manual properly before or after using the unit. Please use the product in accordance with the instructions in this manual.

- Unplug the dehumidifier from the power source when cleaning.
- Do not splash water into the machine or put it near places where it can be splashed.
- Please do not place the machine near a heating device or dangerous inflammable things.
- Do not put your fingers or any hard materials into the air inlet or outlet.
- Do not sit on the unit.
- Drain the water properly (manual or continuous drainage).
- Please make sure that the drain hose is installed on a downward slope so that the water can be drained out properly.
- Do not place the machine on uneven surfaces.
- Do not spray water on this machine.
- Do not spray pesticides or flammable liquid on this machine.
- Do not put or place heavy objects on the machine or place children and pets on the unit.
- Do not place this machine in a confined space.
- If the power cord is damaged, please contact the manufacturer or qualified person to replace it to avoid hazards.
- When using the laundry mode, please keep 15.75 inches; clearance between the clothes and the unit outlet, to avoid the water dripping into the dehumidifier and damaging the unit.
- The wiring of the machine must be in accordance with national wiring regulations. The power cord should be connected to a reliable external naught wire.
- The fixed wiring connected to the machine must be equipped with an all-pole disconnect device (air switch) with a contact distance of at least 0.12 inches.
- The specification of the fuse: 5A/250V.
- At least 39 inches distance shall be kept from the surround objects when using the unit.
- Maintain the minimum clearance around the dehumidifier when the unit is operating as shown at the right.

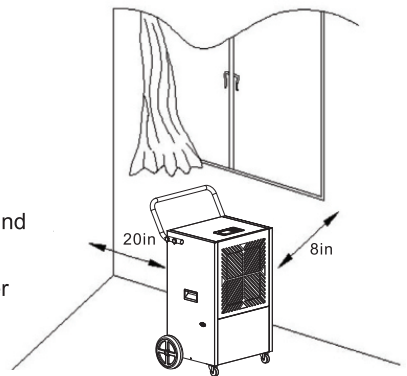

Product Diagram

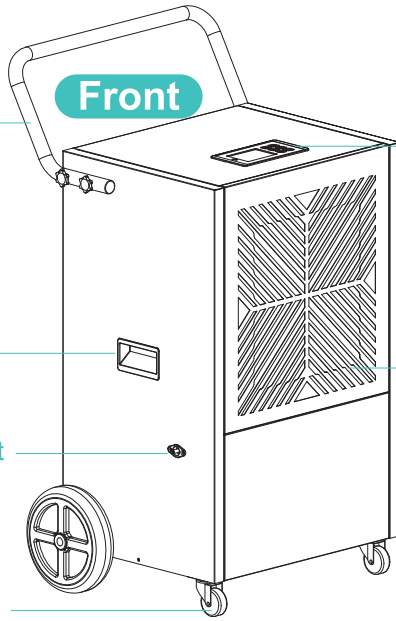

Front

Handle

Control Panel

Embedded Handle

Air Inlet

Pump Drainage Port

Caster

Rear

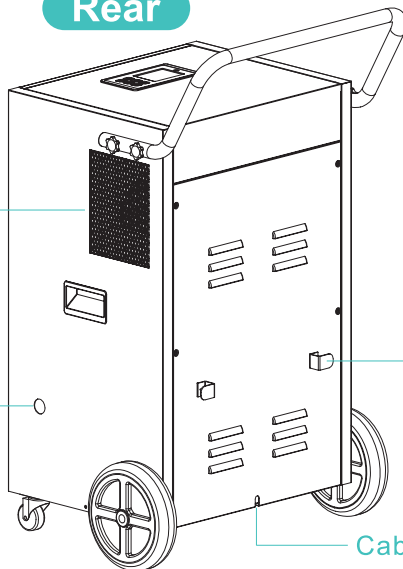

Air Outlet

Power Cord Buckle

Continuous Drainage Port





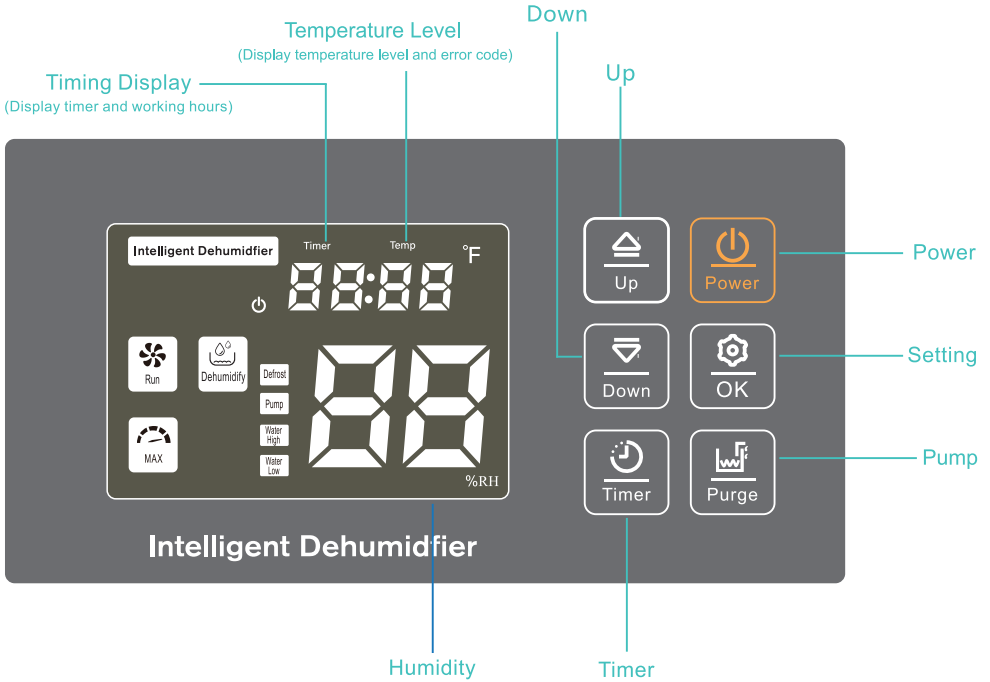

Cable Outlet

Operation Instructions

1. Control Panel





Button Instructions



	Up Turn up the parameters including humidity level, timing or cleaning hours.		Power Turn on or off the unit.
	Down Turn down the parameters including humidity level, timing or cleaning hours.		OK Set up the humidity, timing hours or cleaning mode, etc.
	Timer Turn on or off the timer function or set up the timing hours.		Purge Enable the pump.

Operation Instructions

2. Indicators on the LCD Display

" Intelligent Dehumidifier" lights up when turn on the dehumidifier and lights off when turn it off.



" " lights up when the dehumidifier has been plugged in but not turned on yet.

" " shows the current room humidity. When you press " " or " " button to set the target humidity , it will turn to display the previous setting value and keep blinking.

" " lights up when the fan is running and lights off when it stops running.



" " flickers typically because the compressor is not kicked in. It usually happens when the dehumidifier is under the 3-minute compressor delay status, or the dehumidifier is programmed to delay-start (AUTO ON TIMER).

" " lights up when the setting humidity is 10%, and the dehumidifier enters into continuous mode.

" " flashes when the dehumidifier is defrosting. The dehumidifier will defrost when the frost accumulated on the interior of the dehumidifier. The fan keeps running when defrosting, while the compressor is not. The dehumidifying function will cease until the frost melted. " " will light off when the defrosting completed, then the dehumidifier begins to dehumidify automatically.

NOTE: Frequent defrost process indicates that the room temperature is too low. Therefore, if the room temperature is lower than 60°F, please consider adding heat to promote proper drying.



" " lights up when the pump is in good condition. It will light up once you turn on the dehumidifier. It flashes when the pump is working to drain the water out.

" " and " " will blink when the ambient humidity value is lower than or equal to the preset humidity value. After 30 seconds, the compressor and fan stop working. The dehumidifier will automatically restart when the ambient humidity exceeds the preset value.

Operation Instructions

3. Setting



Power

Press the "  " button to turn the dehumidifier on. When the dehumidifier is on, the "  " indicator lights off, and the " **Intelligent Dehumidifier** " indicator lights up.

Check the Room Humidity

Check the room humidity readout ("  ") on the control panel.



Set a Desired Humidity Percentage Value

Press "  " or "  " button to preset your desired humidity level. The humidity level can be set within a range of 10%RH(Relative Humidity) to 90%RH(Relative Humidity) in 1%RH increment. The setting humidity needs to be at least 5% lower than the room humidity. After setting the target humidity, press "  " or wait 5 seconds to confirm.

NOTE:

1. The dehumidifier will stop and start automatically to maintain room humidity level within a range of $\pm 5\%$ of the preset target humidity.

For example, if the set humidity is 50%:



When the detected humidity is 45%, 5% lower than the preset humidity, the dehumidifier will automatically stop and enter into standby mode, the compressor stops working and indicators "  " and "  " flash.

When detected humidity raises to 55%, 5% higher than the preset humidity, the dehumidifier will automatically restart.

2. If the preset humidity is equal to or higher than the room humidity, the dehumidifier will not start.

3. If the preset humidity level is 10%, the dehumidifier will enter continuous mode and run continuously.

Timer Setting

The "  " function enables you to either delay AUTO-ON or delay AUTO-OFF the dehumidifier in the choice from 1 hour to 24 hours. Press "  " and "  " to adjust the timer by 1 hour increments.

· Setting AUTO-ON timer: When the dehumidifier is off, press "  " to set a timer to automatically start the machine.

· Setting AUTO-OFF timer: When the dehumidifier is on, press "  " to set a timer to automatically shut down the machine.

NOTE:

1. Before setting AUTO-ON TIMER, make sure the dehumidifier is plugged in.

Operation Instructions

2. For AUTO-ON setting, please turn on the dehumidifier to set a desired humidity level. Otherwise, it will maintain the previous setting humidity.
3. You can only set AUTO-ON timer when the dehumidifier is off or set AUTO-OFF timer when the machine is on. It is not able to set both AUTO-ON and AUTO-OFF timer at the same time.
4. The timer will ONLY function one time instead of cycling the dehumidifier on or off indefinitely.
5. The timer function will be disabled when the dehumidifier has been powered on/off manually.
6. Set the timer as 00, the timer function will not be activated.

Drainage Setting

During operation, it will automatically pump the water out via the drain hose when the pump reservoir is full. No need manual intervention.

Before moving the dehumidifier, press "  " to empty the pump reservoir to avoid water spillage.

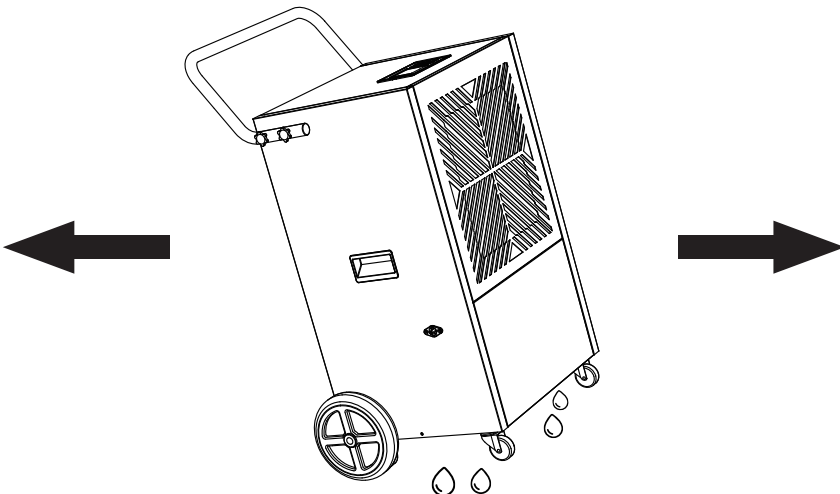

"  " will blink when the pump is draining. The pump will stop working automatically in 40 seconds and stop blinking when the pump reservoir is almost empty.

NOTE: Please press "  " to empty the inbuilt reservoir first to avoid water leakage while moving the dehumidifier.



Operation Instructions

Turn the Dehumidifier off

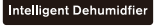
Press " to turn the dehumidifier off. When the machine is turned off, the " indicator lights up, and the " Intelligent Dehumidifier" indicator lights off.

NOTE: To protect the compressor, the fan will continue to operate for 5 seconds after the dehumidifier shuts off. So please do not disconnect the power cord to force the dehumidifier to stop. Always use the " button.

4. Smart Functions

3 Minutes Compressor Delay Mechanism

To avoid any damage to the dehumidifier, the unit will not start working in a 3 minutes complete cycle. In other word, if you turn the dehumidifier off and then restart it immediately, the compressor will not kick in until 3 minutes later. During this period, you can see the " indicator flashing on the LCD screen until the compressor kicks in.

Auto Defrost

When the frost builds up on the evaporator coils, the compressor will stop working and the fan will continue to run until the frost melted. When the dehumidifier is defrosting, you can see the " indicator lights up on the LCD screen.

Auto Drainage

Thanks to the built-in pump, the dehumidifier will drain the condensation water automatically.

Auto-Restart

If the dehumidifier shuts off unexpectedly due to power outage, it will restart with the previous function settings automatically when the power resumes.

The timer function will not be retained and you need to reset it.

Temperature Protection Function

When the room temperature is higher than 113°F, the dehumidifier will automatically enter into HIGH-TEMPERATURE PROTECTION SYSTEM where the LCD screen shows " and the compressor stops working.

When the room temperature is lower than 40°F, the dehumidifier will automatically enter into LOW-TEMPERATURE PROTECTION SYSTEM where the LCD screen shows " and the dehumidifier stops working.

Drainage

Pump Drainage

During operation, the dehumidifier will automatically pump the water out via the drain hose when the pump reservoir is full. No need manual intervention.

Before turning on the dehumidifier, make sure the hose has been connected to the drain outlet properly.

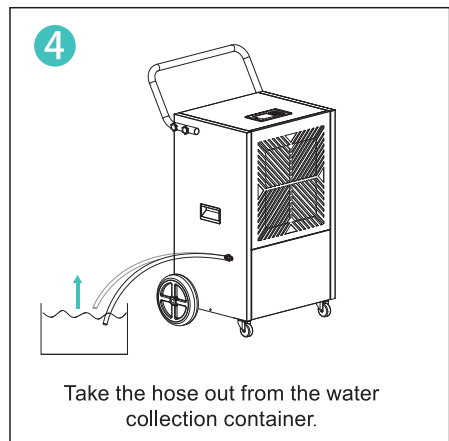
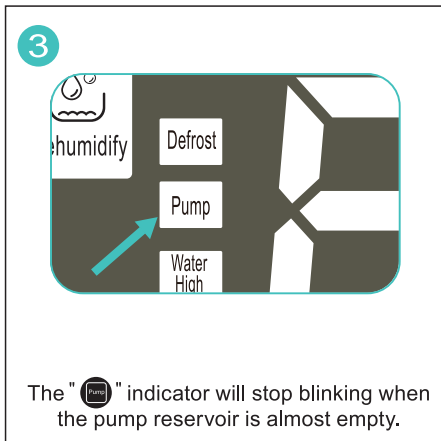
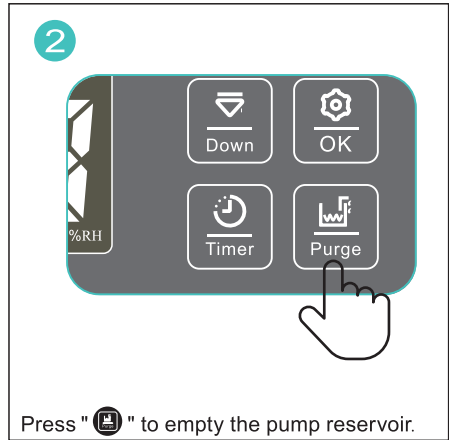
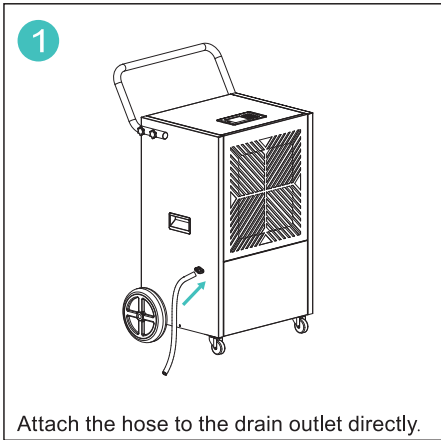

Drainage

NOTE:

Place the unattached end in a sink, drain, bucket or outdoors - anywhere that water can drain out safely. (Ensure there are no kinks or other obstructions that will stop the water to flow.)

If you use a bucket or other container for water collection, check it regularly to prevent overflows. The drain hose for the water pump can drain up to 15ft vertically. More than 15ft may cause water flow back to the pump and result in water leakage.

Continuous Drainage

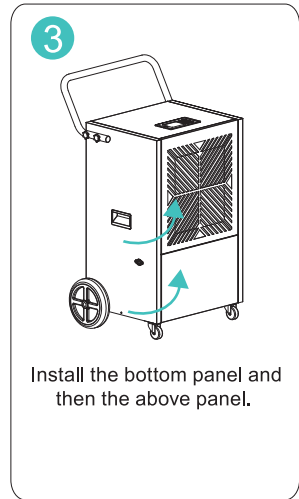
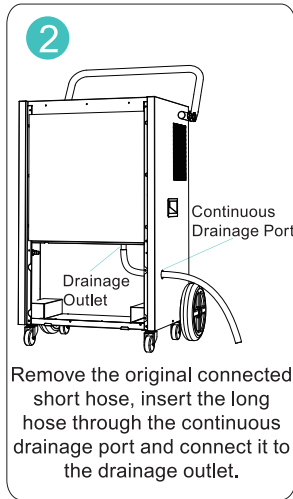
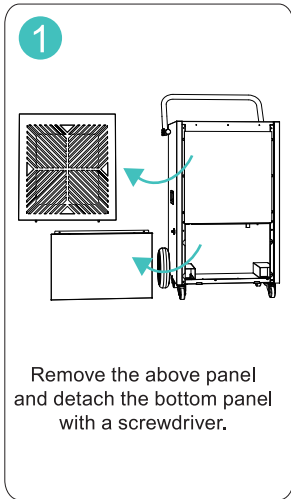

NOTE:

1. Please make sure the connections are tightly connected to avoid water leakage.
2. The hose should be lower than the drain outlet to avoid backflow.
3. The hose cannot be distorted or has substantial turning.

Maintenance

⚠ WARNING:

Ensure the dehumidifier is turned OFF and unplugged before cleaning or maintenance.

Machine Cleaning

Wipe the dehumidifier housing with a soft damp cloth. Do not submerge or place water on the dehumidifier or control panel. Water may damage the electronic components of the machine. Do not use chemical solvents such as benzene, alcohol, gasoline or other heavy-duty cleaners, for they may damage or deform the surface.

Filter Cleaning

It's advised to clean the filter regularly and properly. Make sure clean the filter at least once a month.

1. Open the panel from above and remove the filter.
2. Clean the dust on the surface with the vacuum or flush and wash the filter with detergent and place it at somewhere ventilated. Do not expose the filter to strong sunshine or dry the filter with high temperature, or it may be distorted.
3. Install the filter and close the panel.

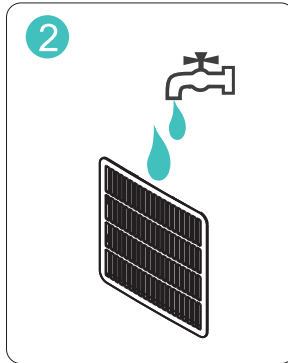

Storage

When the unit is not being used for a long period of time and you want to store it, please following the steps:

1. Press the Purge Button to drain out the water that accumulates at the bottom of the pump. (The recommendation is to operate 2-3 times.)
2. Unplug and wrap the cord with the power cord buckle.
3. Clean the air filter.
4. Cover the unit with a plastic bag.
5. Store the unit upright in a cool and dry place.

Troubleshooting

When the breakdown and problems occurs on the dehumidifier, please refer to the troubleshooting part in the manual. Do not dismantle or repair the unit yourself, for improper repair may cause danger.

If a condition listed below occurs, please check the following items before calling customer service. It may save you time and expense.

Problems	Analyses	Solutions
Not working	Dark Display	Check the power cord socket and the wiring.
	Defrost indicator lights up	Defrost function is running, and the indicator will light off after auto-defrost finished.
	"-H" indicator lights up	The unit shall not used in high-temperature conditions.
	"-L" indicator lights up	The unit shall not used in low-temperature conditions.
Much Noise	The unit is place at uneven surface.	Place the unit at somewhere flat and even.
	The filter may be blocked.	Clean the filter. See "Maintenance".
	The inlet or outlet may be blocked.	Keep the unit inlet or outiet away from objects.

Warning

If the dehumidifier is still not working properly as expected and the troubleshooting steps or solutions above may not resolve the issue, please shut down and unplug the dehumidifier, then contact Kesnos Customer Service at support@kesnos.com.

Error Codes

Error Codes	Handling Method
E1	Replace the temperature and humidity sensor.
E2	Replace the temperature sensor.
E3	Make sure the water tank is well placed , and the WF port is properly connected.
E4	Replace the temperature and humidity sensor.
E6	Make sure the display circuit has been connected right, and the DISPLAY port is well connected.
-H	No problem. The unit resumes working when unit temperature goes down.
-L	No problem. The unit resumes working when unit temperature goes up.

1. If the problems persist, please turn off and unplug the dehumidifier, and contact Kesnos Customer Service: support@kesnos.com.

2. When E1, E2 and E4 fault alarm, the dehumidifier can operate normally, but some functions are disabled. The dehumidifier will automatically resume to operate after the fault is eliminated.

Special Notes



- 1 When using the machine, please do not put it on a soft or uneven ground to prevent vibration and movement.

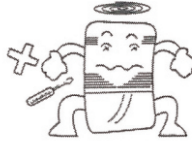

- 2 Do not insert any thin rods or hard items into the machine to prevent malfunctions and dangers.

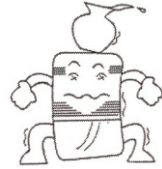

- 3 Please do not put any objects on the dehumidifier.



- 4 When using the machine, please keep it away from any heating furnaces, electric kettles and other heating sources.

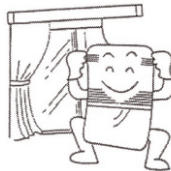

- 5 When using the machine, please close doors and windows for the optimal moisture removal effect.

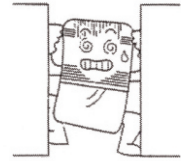

- 4 Please do not put any objects around the machine. The dehumidification effect will be affected if the ventilation is bad.



- 7 Please unplug the machine from the power source if you do not use it for a long time.



- 8 When cleaning the machine, please use wet cloth to wipe gently. Do not spray water on it directly.



- 9 Please clean the filter every two weeks. Do not use hot water above 104°F, alcohol, gasoline or toluene.



- 10 After cleaning the filter, please do not dry it under direct sunlight to prevent it from deforming.



- 11 When using the hose to drain continuously, please place the hose horizontally and make sure it is even and not winded.



- 12 Before moving or carrying the machine around, please empty the water tank first.

Specifications

MODEL	DP902A
POWER SOURCE	115V~60Hz
TOTAL INPUT CURRENT	11.3A
MOISTURE REMOVAL (65°F, 60%RH)	72 Pints/Day (34L/Day)
MOISTURE REMOVAL (80°F, 60%RH)	115 Pints/Day (54L/Day)
MOISTURE REMOVAL (86°F, 80%RH)	190 Pints/Day (90L/Day)
MOISTURE REMOVAL (95°F, 90%RH)	216 Pints/Day (102L/Day)
INPUT POWER (65°F, 60%RH)	790W
INPUT CURRENT (65°F, 60%RH)	8.1A
MOTOR FLA	1.2A
MOTOR COMPRESSOR (RLA/LRA)	RLA:9.4A LRA:47A
REFRGERANT	R410a/650g
MAXIMUM ALLOWABLE PRESSURE	5.5MPa (800PSIG)
HIGH PRESSURE	4.0MPa (580PSIG)
LOW PRESSURE	1.7MPa (247PSIG)

If specifications are changed in the future, the product nameplate will reflect the new specifications.

The working temperature range of this machine is between 41°F (5°C) and 100°F (37.8°C).

If the room temperature is not within this range, the unit will not operate normally.

 WARNING:

This product can expose you to chemicals including Styrene and its compounds, which are known to the State of California to cause cancer and birth defects or other reproductive harm. For more information, go to: www.P65Warnings.ca.gov

Warranty & Contact Us

Warranty

Kesnos offers a 12-month warranty to all of our products together with the original proof of purchase when a defect occurred, including those newly purchased and unused, from Kesnos or through an authorized reseller, wholly or substantially, or as a result of faulty manufacturing parts, or workmanship during the Warranty Period.

The warranty does not apply if damage is caused by other factors, including but without limitation of:

- (a) Normal wear and tear;
- (b) Abuse, mishandling, accident or failure to follow operating instructions;
- (c) Exposure to liquid or infiltration of foreign particles;
- (d) Servicing or modification of the product other than by Kesnos.

There are our general terms for the warranty service, but we always encourage our customers to contact us if any issues, regardless of warranty terms. If you are experiencing an issue with Kesnos product, you can reach out to us at support@kesnos.com, we will dedicate our efforts to resolve it for you.

Extend Your Warranty by 1 Year

Remember to register your product on www.kesnos.com within 14 days of receiving, to extend your 1-year warranty by an additional year.

*Please fill out all required fields and include your Order ID, Date of Purchased if applicable.

Customer Support

If you have any questions or concerns about our product, please feel free to contact our expert support team. Kesnos customer service is ready to help.

Kesnos Office

805 Victory Trail Rd, Gaffney, SC 29340 USA

Email: support@kesnos.com

Live Chat: www.kesnos.com

Support Hours

24 Hours available

*Please have your Order Number ready before contacting customer support.

KESNOS

For FAQs and more information please visit:

www.kenos.com



@Kesos



@Kesos



@Kesos



@Kesos



(Scan the QR Code for Live Chat)

We are expecting to see our products fulfill your life and hear your voice.

Your satisfaction means a lot to us.

Please tag us if you share a snap on your social media.

www.kenos.com