

KESNOS

Home Dehumidifier

Please read the manual carefully
before using the unit

PD160A

USER MANUAL

FOR CUSTOMERS

Thank you for purchasing our dehumidifier.

Kesnos wishes that our products and services can bring convenience to your work and life. We highly recommend that you keep the manual for reference if you encounter unexpected events using the unit.

Please read the manual carefully to ensure proper use of the dehumidifier. Our dehumidifiers are widely used in family bedrooms, bathrooms, basements, offices and storage rooms, etc.

The dehumidifiers from Kesnos provide quick and efficient operation to reduce room's humidity and bring you a healthy and comfortable life.

TO ACCESS CUSTOMER SUPPORT FASTER

If there is any problem of the product, please contact Kesnos Customer Service at support@kesnos.com with your Purchase Order ID to help you address the problem more effectively.

BEFORE FIRST USE:

To prevent any internal damage, it is very important to keep refrigeration units (like this one) upright throughout their journey.

Please leave it standing upright and outside the box for **24 HOURS** before plugging it in.

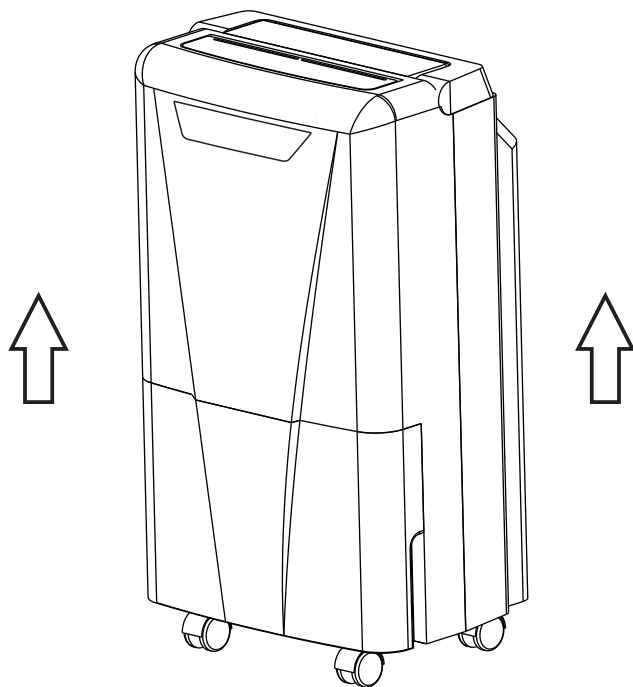

TABLE OF CONTENTS

| | |
|-----------------------------|----|
| Safety Instructions..... | 01 |
| Parts Description | 02 |
| Control Interface..... | 03 |
| Operation Instructions..... | 04 |
| Cleaning & Maintenance..... | 10 |
| Troubleshooting..... | 11 |
| Special Notes..... | 14 |
| Technical Parameters..... | 15 |
| Warranty & Contact Us..... | 16 |

Statement

The graphics and functions provided in this manual may not be the same as the actual product. Please always refer to the actual product.

The model of the machine on the manual is for reference only, please check the corresponding content and operate the machine based on the actual product.

The right to interpret the relevant terms belongs to the company.

SAFETY INSTRUCTIONS

Safety Notes :

For your safety, please read the manual carefully and keep the manual for future reference.

Please use this product according to the instructions of installation and operation of this manual.

- Unplug the power supply cord before cleaning or storage.
- Do not immerse the unit in water, or place it close to water.
- Do not put the unit close to heat-generating devices or near flammable and dangerous materials.
- Never put your fingers or any stick-form objects into the air inlet or outlet grilles.
- Discard water collected in the tank as instructed.
- Install the draining hose at a downward direction to make sure that condensed water can be drained continuously.
- Place and operate the unit on a stable and level floor.
- Do not spray or splash water directly onto the unit.
- Do not spray any pesticide nor flammable liquid onto the unit.
- Do not place any heavy object or let children and pets sit on the unit.
- Do not operate dehumidifier in a small and confined space.
- Damaged power cord must be replaced by a licensed technician.
- Keep the clothes at least 40 cm from the air outlet to prevent water from dripping to the unit.
- Machine power supply wiring must be conducted according to national wiring rules.
- Power wire need to be connected with the external grounding line.
- This appliance can not be used by children aged under 8 years old and persons with reduced physical, sensory or mental capabilities or lack of experience and knowledge unless they have been given supervision or instructions concerning use of the appliance in a safe way and understand the hazards involved. Children shall not play with the appliance. Cleaning and user maintenance shall not be made by children without supervision.
- Fuse model specifications:3.15A.
- This dehumidifier is designed to operate in a working environment between 41°F(5°C) and 95°F (35°C).
- When using the dehumidifier, other objects surrounding the machine need to be kept at least a distance of 7.9 inches (20cm) as shown in the picture on the right:

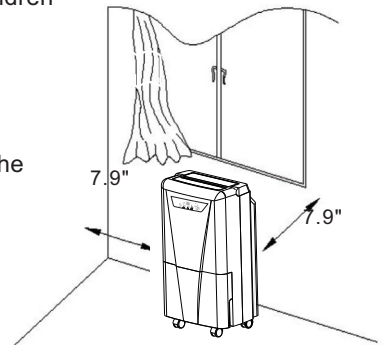

PARTS
DECARPTION

Front

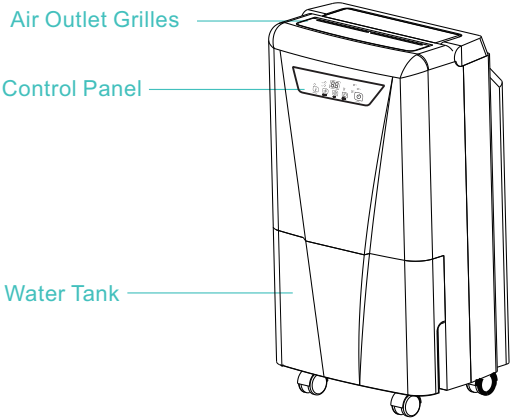

Rear

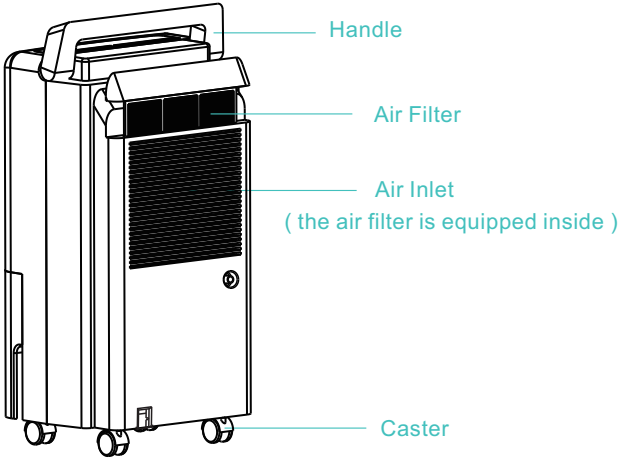

1. Control Panel

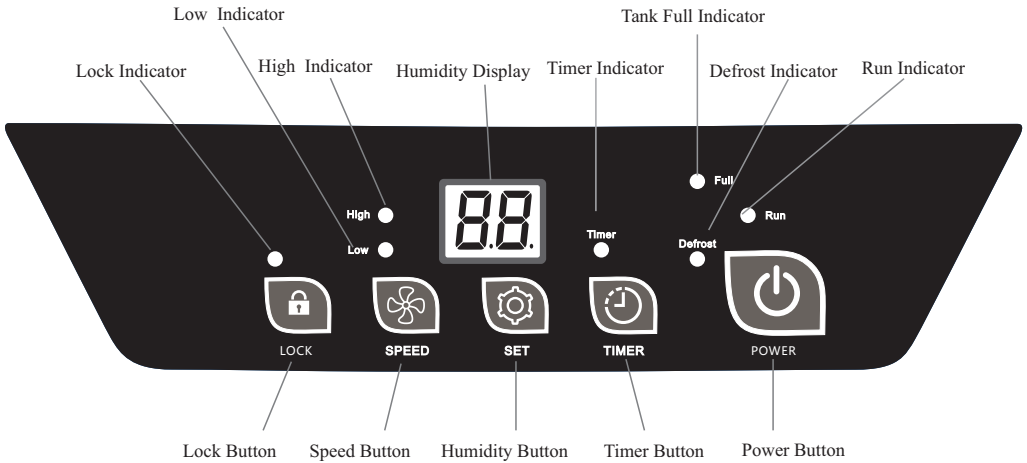

Power Button

Press to turn on/off the machine.



Timer Button

Press the "TIMER", you can set the timer by 1-hour increment within the range of 1-24 hours.



Humidity Button

When power-on status, press the "SET" button to set the humidity value in 5%RH increments.



Speed Button

Press to switch to "High" wind speed or "Low" wind speed.



Lock Button

Press the button and hold for 2 seconds and the control panel will be locked.

2.Setting

Humidity Setting

When power-on status, press the "SET" button to set the humidity value within the range of 30%RH-80%RH in 5%RH increments (can be set again after invalid).

Long press the button for seconds, you can adjust the humidity value continuously. After no operation for seconds, you will exit the setting status automatically.

When the humidity level is set at 30%RH, the dehumidifier will work at continuous dehumidifying mode.

Timing Setting

This TIMER setting function is designed for you to set a time to turn off (when the machine is on) or turn on (when the machine is off) the machine, automatically by the timer.

Press the "TIMER" button, the "Timer" indicator will flash, you can set the timer by 1-hour increment within the range of 1-24 hours, which can be reset after invalid.

If you set the timer successfully, the "Timer" indicator light will be on, the screen will display the current humidity, but when you press the "TIMER" again, you can see the remaining setting time.

If the time is set to 00, this is called the invalid time.

Wind Speed Setting

In power-on status, you can press the "SPEED" button to choose the "High" wind speed or "Low" wind speed.

Lock Setting

When the machine is turned on, press "LOCK" button for more than 2 seconds, the control panel will be locked.

To unlock this status, press this button again for more than 2 seconds.

OPERATION INSTRUCTIONS

Water Overflow Protection

When the water tank is full of water, the machine will turn off automatically, the "Full" indicator light will flash.

After you empty the water tank, this indicator light will go out, and the machine will restart to work.

Caution: The water tank must be placed in right position, otherwise it will cause the WATER FULL alarm as well.

Defrost Function

When the dehumidifier is running at a lower temperature, the system will automatically determine whether there is a presence of frost. If any frost exists, it will defrost automatically.

The fan will runs at high wind speed and the compressor will stop.

During the defrosting process, the "Defrost" indicator will flash.

Action Description

Power on:

Compressor starts after the fan work for a few seconds.

Power off:



Compressor shuts down at once, and the fan will stop after a few seconds. (When other malfunction occurs, or the humidity reaches the desired level, the fan will stop after tens of seconds).

The compressor features "3 minutes delay protection" function— When the dehumidifier is powered, the compressor can only start 3 minutes after its last shutdown.

3. Display Status Description

When the device is powered on, before any further operations, the "  Run " indicator light will flash, and will be on when the machine start working.

When the humidity drops to what you desire, the dehumidifier will automatically stop and the humidity value on the screen and the "  Run " indicator light will flash, indicating the wet control status.

When the machine is working in high speed status, the "  High " indicator light will be on; when the machine is working in low speed status, the "  Low " indicator light will be on.

When the timer is successfully set, the "  Timer " indicator light will be on, otherwise it will be off.

When in defrosting status, the "  Defrost " indicator light will be on, otherwise it will be off.

When the water tank is full, the "  Full " indicator light will be on.

4. Faults & Processing Methods

| Fault Phenomenon | Analysis of Causes | Processing Method |
|---|---|--|
| Humidity always shows "25%RH"(There is a big difference from the actual humidity) | Humidity sensor failure? | <p>Set the humidity to 30%RH, the dehumidifier can still continue to work, and can be used normally.</p> <p>Repair and replace the humidity sensor.</p> |
| Humidity always shows "99%RH"(There is a big difference from the actual humidity) | <ol style="list-style-type: none"> 1. Water on the surface of the humidity sensor? 2.Humidity sensor failure? | <p>The dehumidifier is not affected and can continue to work, and can be used normally.</p> <p>Please let the dehumidifier keep working for a period of time, after the water on the surface of humidity sensor is removed, it will return to normal.</p> <p>Repair and replace the humidity sensor.</p> |

If the malfunction is still present, please don't hesitate to contact Kesnos Customer Service at support@kesnos.com for help.

Note:

Before starting the machine, please ensure that the air outlet has been opened, otherwise the machine will overheat. Do not pull out the power cord directly to stop the machine.

5. Empty The Water Tank

Two ways are available to remove the collected water.

Use the Water Tank

When the water tank is already full, the WATER FULL indicator will light up, the dehumidifier will automatically shut down until the tank has been emptied and placed back to the unit.

Empty the Water Tank

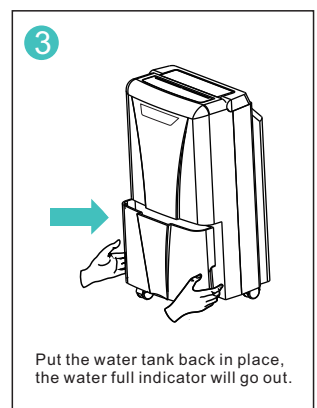
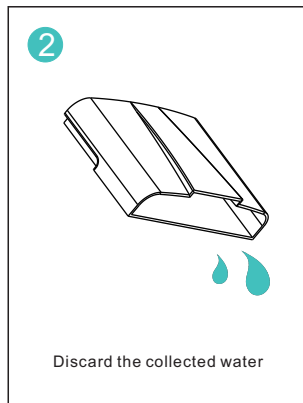
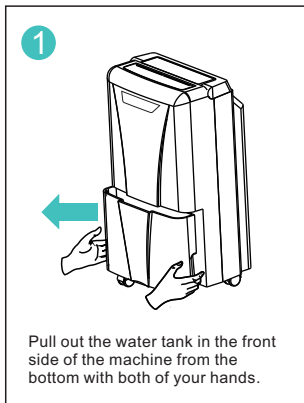

Note: Please insert the rubber plug into the continuous drainage port when using the water tank for draining.

OPERATION INSTRUCTIONS

Note:

- Do not remove the float from the water tank. If the float in the water tank is removed, the sensor may not be able to determine the water level stored in the tank properly that may lead to water overflow leak from the water tank.
- If the water tank is dirty, just use cold water or warm water to clean it. Do not use detergent, steel wool, chemically treated dust cloth, gasoline, benzene, thinner or other solvents. Otherwise, it may damage the water tank and cause it to leak.
- When placing back the water tank, use your hands to press the tank back in its place. If the water tank is not placed properly, sensors or protections from water overflow may not operate as expected.

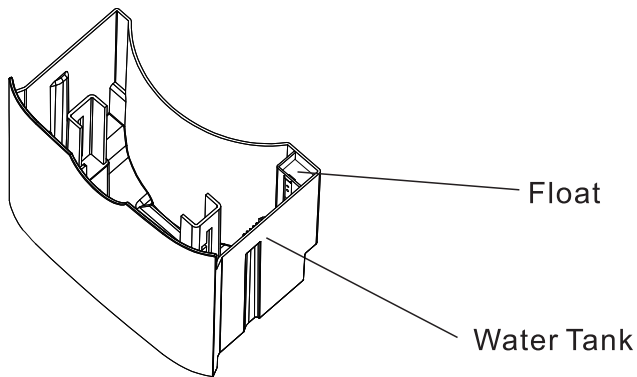

6. Continuous Drainage

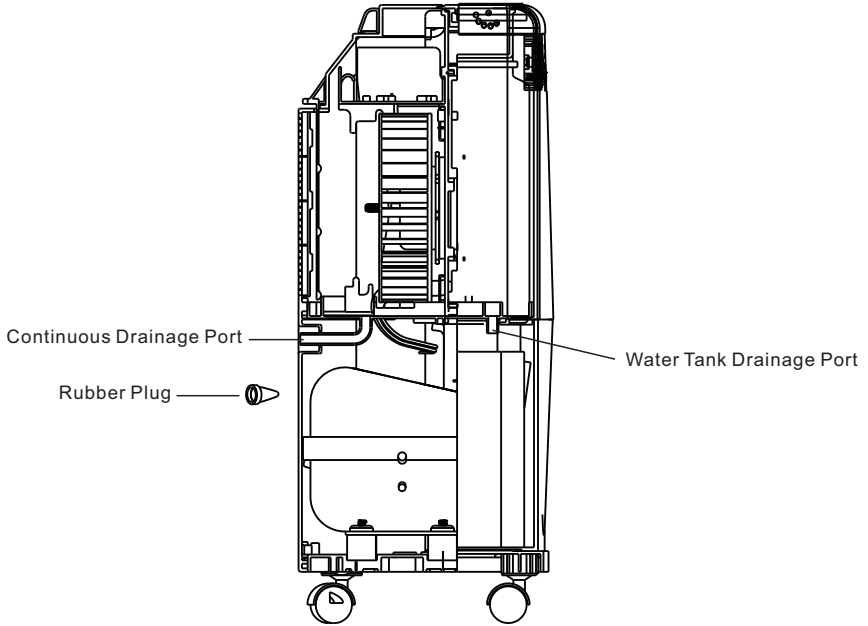

Pull out the black rubber plug, insert the water hose into the continuous drainage port for draining.

The outlet of the water hose should be lower than the continuous drainage port by more than 3.9 inches, and the water hose cannot be bent.

Make sure the connection is tight and there is no leaking.

Note:

Please insert the rubber plug into the water tank drainage port when using continuous drainage.

When the continuous drainage function is not being use, please remove the drainage hose from the continuous drainage port.

CLEANING AND MAINTENANCE

⚠ WARNING:

Turn the dehumidifier off and remove the plug from the wall outlet before Cleaning.

A- Cleaning the dehumidifier body

Please use only a soft and a bit wet textile or cloth to clean it.

B- Cleaning filter

1. Pull out the filter.
2. Clean the filter: Use a vacuum cleaner to gently remove the dust from the surface of the filter. If the filter is very dirty, wipe it with warm water and a mild detergent and dry it completely.
3. Slowly insert the filter back into the machine body.

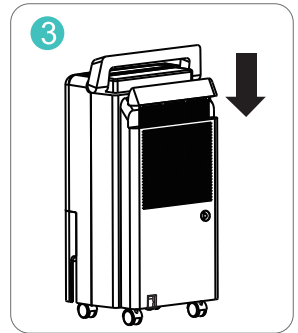
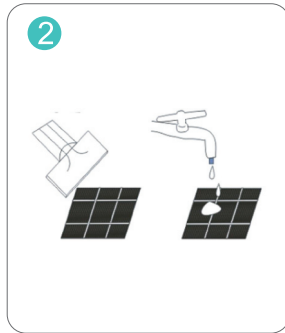
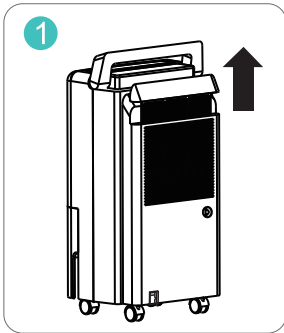

C-Dehumidifier storage

When you want to store the dehumidifier because you don't use it for a long time. Please pay attention to the following steps:

1. Empty the water in the water tank.
2. Roll up the power cord and tie it up.
3. Clean the filter.
4. Place the machine in a cool and dry environment.

TROUBLESHOOTING

Check the information below for troubleshooting steps, it will save you time to resolve issues that may happen with the unit.

The list includes most of the common cases, but not the results of defective unit, crafts or materials in the unit.

If all troubleshooting steps have been exhausted and the issue is still occurring, please feel free to reach out to Waykar Customer Service to get further assistance.

| Problem | Reason | Method |
|----------------------------|---|---|
| Dehumidifier does not work | The power cord is unplugged. | Make sure that the unit's plug is inserted properly into the power outlet. |
| | Is the Full Tank indicator blinking? (The tank is full or in a wrong position.) | Empty the water in the water tank and then reposition the tank. |
| | Is the room temperature above 95°F (35°C) or below 41°F (5°C). | This product does not apply to over hot or cold environment, the machine will automatically enter the protection mode. It is a normal phenomenon. |
| | Is the room temperature between 41°F(5°C) and 68°F(20°C) ? | When running under lower ambient temperature, the machine will automatically defrost, which is a normal phenomenon. It will restart dehumidification again until the defrosting process finished. |
| | The dehumidifier is in the defrosting process. | It is normal the compressor ceases while defrosting process. Wait until the process finished, it will restart dehumidification again. |
| | Is the room humidity lower or reaching the preset humidity level? (When the room humidity has reached the preset level, the dehumidifier will enter Standby Mode and the indicator on LCD will flash.) | Please set the humidity decrease by 5% than the room humidity or set the humidity to 30%. |
| | This is to prevent the frequent start of the machine. Does the machine stop working just now? | Please wait for more than 3 minutes. |
| | Room humidity is low. | The dehumidifier is designed to work in the humidity range of 30%-80%. Above or below this range, it will not work. |

TROUBLESHOOTING

| | | |
|--|--|--|
| Dehumidifier does not dry the air as it should | The air filter is dirty. | Clean the air filter. |
| | Is the air inlet or air outlet obstructed? | Remove the obstruction from the air inlet or outlet. |
| | The dehumidifier size is too small for application. | Increase the quantity of dehumidifier. Or change to a higher capacity dehumidifier. |
| | Poor air circulation. | Please leave about 7.9inch (20cm) around the product |
| | Did not allow enough time to remove the moisture. | Allow enough time to remove the moisture. When first installed, allow at least 3-4 days to maintain the desired RH. |
| | The room has not been sealed properly. | Check that all doors, windows and other openings are securely closed. |
| | Room temperature is too low, or below 41°F (5°C): The machine will not work or undergo poor dehumidifying efficiency in low temperature. | Please wait until the temperature rises to above 5°C or higher. |
| The dehumidifier makes loud noise when operating | The dehumidifier is not positioned levelly. | Move the machine to a horizontal position. |
| | Is there blocking around the air inlet? The air filter is clogged. | Clean up the dirt or lint on the air outlet and intake. |
| | Is the filter installed correctly? | Please check whether the packing bag of the filter had been removed and the filter has been installed correctly. |
| Dehumidifier operates continuously | Check if the dehumidifier is in Continuous Mode | Do Not set the humidity too low. Typically, 40-50% are good for use. |
| | Room humidity is too high. | Change humidity settings. Or change to a higher capacity dehumidifier. |
| | Doors and windows are open. | Ensure that all doors, windows and other openings are closed. |

TROUBLESHOOTING

| | | |
|----------------------------|--|--|
| Overflow of water on floor | Hose to connector or hose connection may be loose. | Connect the hose with the drainage port tightly. |
| | The water tank has not been installed properly. | Re-install the water tank properly. |
| | The float of water tank has been stuck. | Move the float and let it swing freely. |
| | The magnet on the float has come off. | Put the magnet in right position. |

Warning:

If the dehumidifier is still not working properly as expected and the troubleshooting steps or solutions above may not resolve the issue, please unplug the power and shut down the dehumidifier then contact Kesnos Customer Service support@kesnos.com.

SPECIAL NOTES



1. When using, please do not put the machine at the soft and uneven ground, avoid vibration and movement.

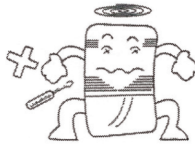

9. Do not insert thin rods and hard objects into the machine body to avoid malfunction and danger.

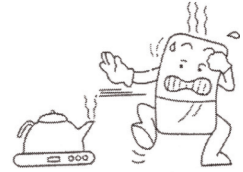

3. When using, please keep the machine away from heating furnace, electric kettle and other heat sources.

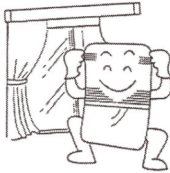

4. When using, make sure doors and windows are closed to get the best humidity removal effect.

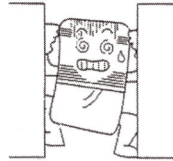

5. Please do not put objects around the body. If the ventilation is blocked, the dehumidification effect will be affected.



6. If do not use the product for a long time, please unplug the power cord.



7. When cleaning the dehumidifier, please use the wet textile to wipe gently, do not shoot the water directly.



8. Please do not put any object on the dehumidifier.



9. Please clean the filter every two weeks (do not use hot water above 104°F, alcohol, gasoline or toluene.).

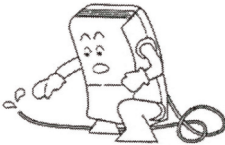

10. When continuous drainage, the drainage hose must be placed horizontally, without unevenness and winding.



11. After cleaning the filter, please do not dry it under direct sunlight, in case deformation.



12. Before moving and carrying the machine, please first pour out the water in the tank.

TECHNICAL PARAMETERS

| | |
|---------------------------------|---------------------------|
| MODEL | PD160A |
| POWER SOURCE | 120V ~ 60Hz |
| RATED POWER (95°F, 90%RH) | 230W |
| RATED CURRENT (95°F, 90%RH) | 2.0A |
| MOISTURE REMOVAL (65°F, 60%RH) | 9.0 Pints/Day (4.25L/Day) |
| MOISTURE REMOVAL (80 °F, 60%RH) | 14 Pints/Day (6.6L/Day) |
| MOISTURE REMOVAL (86 °F, 80%RH) | 25 Pints/Day (12L/Day) |
| MOISTURE REMOVAL (95 °F, 90%RH) | 34 Pints/Day (16L/Day) |
| INPUT POWER (65°F, 60%RH) | 128W |
| INPUT CURRENT (65°F, 60%RH) | 1.2A |
| IEF(65°F, 60%RH) | 1.30 liters/kWh |
| MOTOR FLA | 0.19A |
| MOTOR COMPRESSOR | RLA: 2.5A LRA: 10.0A |
| REFRIGERANT | R134a/5.11ozs (145g) |
| MAXIMUM ALLOWABLE PRESSURE | 363PSIG (2.5MPa) |
| HIGH PRESSURE | 232PSIG (1.6MPa) |
| LOW PRESSURE | 90PSIG (0.62MPa) |
| DIMENSIONS | 12.2*8.3*20.9 inches |
| NET WEIGHT | 26.5LB |

WARNING:

This product can expose you to chemicals including Styrene and its compounds, which is known to the State of California to cause cancer and birth defects or other reproductive harm. For more information, please visit: www.P65Warning.ca.gov.

WARRANTY AND CONTACT US

Warranty

Kesnos offers a 12-month warranty to all of our products together with the original proof of purchase when a defect occurred, including those newly purchased and unused, from Kesnos or through an authorized reseller, wholly or substantially, or as a result of faulty manufacturing parts, or workmanship during the Warranty Period.

The warranty does not apply if damage is caused by other factors, including but without limitation of:

- (a) Normal wear and tear;
- (b) Abuse, mishandling, accident or failure to follow operating instructions;
- (c) Exposure to liquid or infiltration of foreign particles;
- (d) Servicing or modification of the product other than by Kesnos.

There are our general terms for the warranty service, but we always encourage our customers to contact us if any issues, regardless of warranty terms. If you are experiencing an issue with Kesnos product, you can reach out to us at support@kesnos.com, we will dedicate our efforts to resolve it for you.

Extend Your Warranty by 1 Year

Register your product at www.kesnos.com to extend your 1-year warranty by an additional year.

*Please fill out all required fields and include your Order ID, Date of Purchased if applicable.

Customer Support

If you have any questions or concerns about your product, please feel free to contact our expert support team. Kesnos customer service is here to help.

Kesnos Office

13211, Spring Street Baldwin Park, CA, US

Email: support@kesnos.com

Live Chat: www.kesnos.com

Support Hours

24 Hours available

*Please have your Order Number ready before contacting customer support.

KESNOS

For FAQs and more information please visit:

www.kenos.com



@Kesos



@Kesos



@Kesos



@Kesos



(Scan the QR Code for Live Chat)

We are expecting to see our products fulfill your life and hear your voice.

Your satisfaction means a lot to us.

Please tag us if you share a snap on your social media.

www.kenos.com