

# KESNOS

## Home Dehumidifier

Please read the manual carefully  
before using the unit

**PD08A-18**

USER MANUAL

## FOR CUSTOMERS

Thank you for purchasing our dehumidifier.

**Kesnos** wishes that our products and services can bring convenience to your work and life. We highly recommend that you keep the manual for reference if you encounter unexpected events using the unit.

Please read the manual carefully to ensure proper use of the dehumidifier. Our dehumidifiers are widely used in family bedrooms, bathrooms, basements, offices and storage rooms, etc.

The dehumidifiers from Kesnos provide quick and efficient operation to reduce room's humidity and bring you a healthy and comfortable life.

## TO ACCESS CUSTOMER SUPPORT FASTER

If there is any problem of the product, please contact Kesnos Customer Service at [support@kesnos.com](mailto:support@kesnos.com) with your Purchase Order ID to help you address the problem more effectively.

# BEFORE FIRST USE:

To prevent any internal damage, it is very important to keep the unit (like this one) upright throughout its journey.

Please leave it standing as the picture shown below and outside the box for **24 HOURS** before plugging it in.

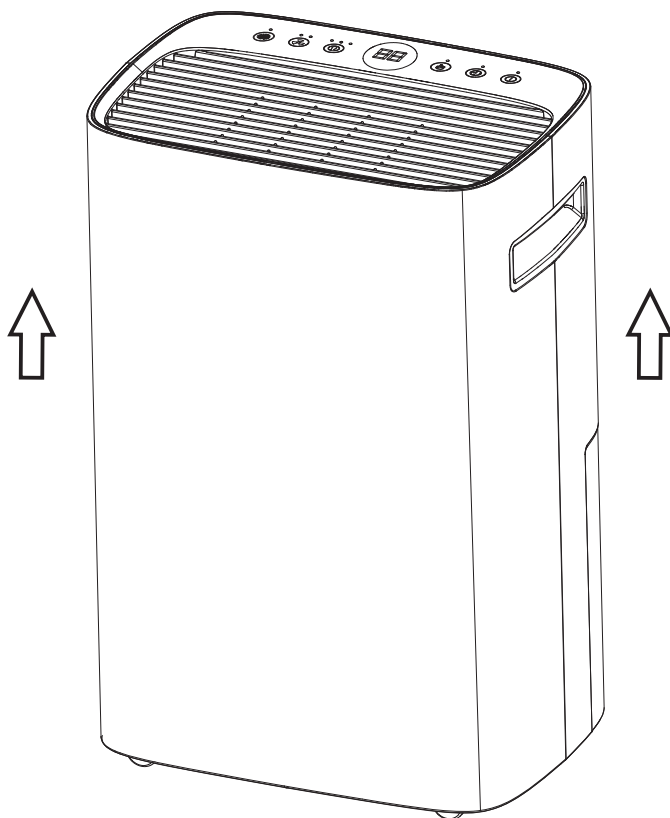

---

# TABLE OF CONTENTS

Safety Instructions.....	1
Parts Description .....	4
Control Interface.....	5
Operation Instructions.....	6
Cleaning & Maintenance.....	14
Troubleshooting.....	15
Special Notes .....	18
Technical Parameters.....	19
Warranty & Contact Us.....	20

## Statement

The graphics and functions provided in this manual may not be the same as the actual product. Please always refer to the actual product.

The model of the machine on the manual is for reference only, please check the corresponding content and operate the machine based on the actual product.

The right to interpret the relevant terms belongs to the company.

# SAFETY INSTRUCTIONS

## Safety Notes:

For your safety, please read the manual carefully and keep the manual before you use the manual for reference. Please use this product according to the instructions of installation and operation of this manual.

## Warning

- Make sure to turn off and unplug the dehumidifier before cleaning.
- Do not touch the plug with wet hands.
- Do not operate or turn off the dehumidifier by plugging in or unplugging the device. Use the control panel instead.
- Be sure to run the slopping water hose downward to let the water flow out smoothly.
- Do not use if the power cord is broken or damaged.
- Do not place or operate in a wet room such as bathroom or laundry room, which may be splashed by water.
- Do not place the dehumidifier near a heat source.
- Do not install the dehumidifier in a location that may be exposed to combustible gas.
- Do not use the dehumidifier near flammable gas or combustibles, such as gasoline, benzene and thinner, etc.
- Do not use in areas where chemicals are handled.
- Do not climb on or place objects on the dehumidifier.
- Do not place a heavy object on the power cord and make sure that the cord is not compressed.
- Place the dehumidifier on a level, sturdy section of the floor, and avoid placing on uneven or tilted section.
- Disconnect the power if strange sounds, smell, or smoke comes from the dehumidifier.
- Do not take the water tank out while the dehumidifier is working.
- Do not cover the intake or exhaust openings with cloths or towels.
- Care should be taken when using the dehumidifier in a room with the following persons: infants, children, the elderly and people not sensitive to humidity.
- Never insert your fingers or other foreign objects into grilles or openings. Take special care to warn children of these dangers.
- You should never try to take apart or repair the grilles by yourself.
- Do not drink or use the water drained from the dehumidifier.
- Always insert the filters securely. Make sure to clean the filter once every month.
- Do not use the dehumidifier in very small spaces.
- If water enters the dehumidifier, please turn the dehumidifier off and disconnect the power, contact Kesnos Customer Service at [support@Kesnos.com](mailto:support@Kesnos.com) in order to avoid a hazard.

## SAFETY INSTRUCTIONS

- This appliance can not be used by children aged under 8 years old and persons with reduced physical, sensory or mental capabilities or lack of experience and knowledge unless they have been given supervision or instructions concerning use of the appliance in a safe way and understand the hazards involved. Children shall not play with the appliance. Cleaning and user maintenance shall not be made by children without supervision.
- This dehumidifier is designed to operate in a working environment between 41°F(5°C) and 95°F(35°C), 30%RH-90%RH.
- When using dehumidifier, other objects surrounding the machine at least need to keep a distance of 7.9 inches (20cm), as shown below:

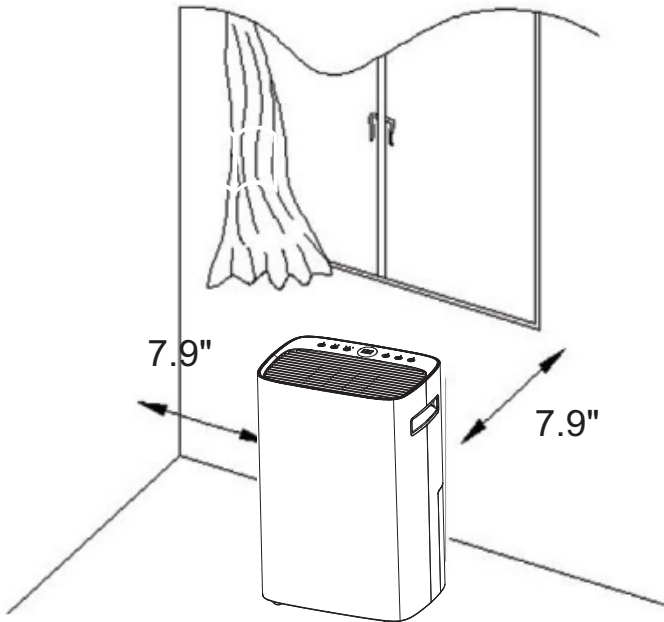

# SAFETY INSTRUCTIONS

## CAUTION

- If the dehumidifier is knocked over during use, turn off the dehumidifier and unplug it from the main power supply immediately. Visually inspect the dehumidifier to ensure there is no damage. If you suspect the dehumidifier has been damaged, contact Kesnos Customer Service at [support@kesnos.com](mailto:support@kesnos.com) for repair or replacement.
- To reduce the risk of fire or electric shock, do not use this dehumidifier with any solid-state speed control device.
- Details of type and rating of fuses: T; 250VAC; 3.15A.
- Do not operate dehumidifier with a damaged cord or plug to avoid a hazard, it must be replaced by the manufacturer or its service agent. Please contact Kesnos Customer Service at [support@kesnos.com](mailto:support@kesnos.com) for repair or replacement.
- The dehumidifier shall be installed in accordance with national wiring regulations.
- The fixed wiring of the machine connection must be equipped with an all-pole disconnect device (air switch) with at least 0.118-inch distance of electric shock.
- Be sure the dehumidifier is properly grounded. To minimize shock and fire hazards, proper grounding is important. This power cord is equipped with a three-prong grounding plug for protection against shock hazards.
- Your dehumidifier must be used in a properly grounded wall socket. If your wall socket is not adequately grounded or protected by a time delay fuse or circuit breaker, have a qualified electrician install the proper socket.
- To avoid fire hazard or electric shock, do Not use an extension cord or an adapter plug, do Not remove any prong from the power cord.

PARTS  
DESCRIPTION

Front

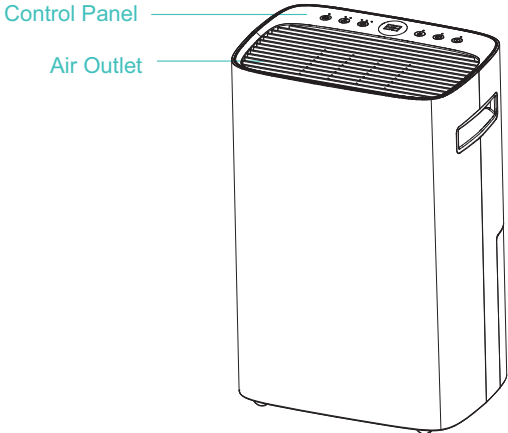

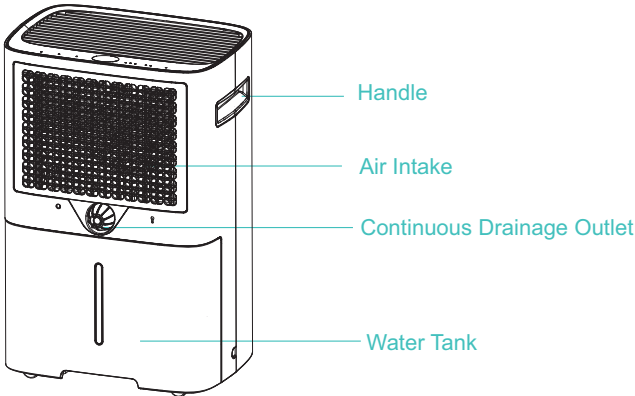

Rear





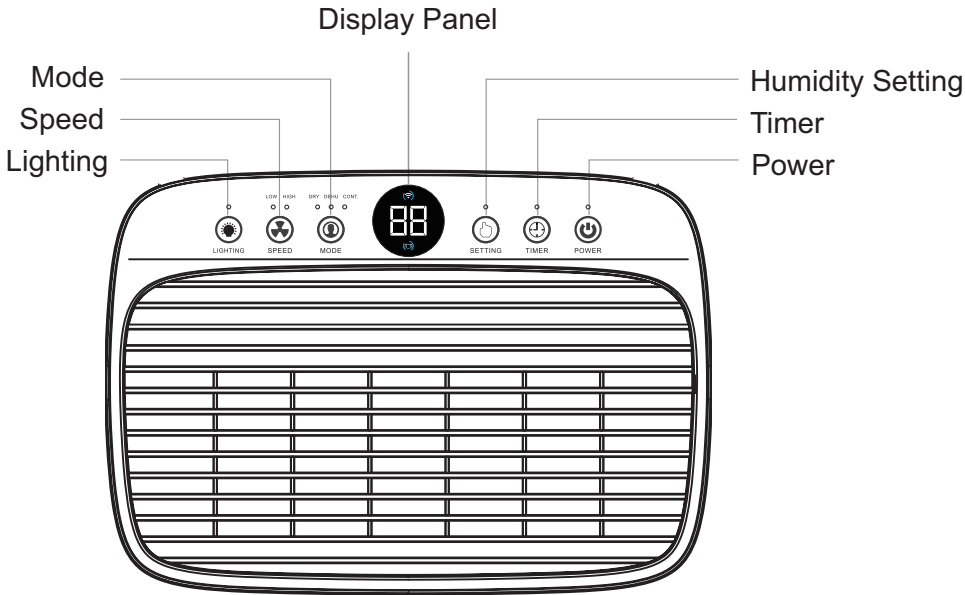

# 1.Control Panel





 **Power Button**  
Press to turn the dehumidifier on and off.

 **Humidity Setting Button**  
Set the humidity up/down.

 **Mode Button**  
Press mode button to choose function.

 **Timer Button**  
Press to initiate the auto-start or auto-stop feature.

 **Lighting Button**  
Turn the LED panel's light on/off.

 **Speed Button**  
Control the fan speed.

## 2.Setting

### Mode Setting

3 modes are available: Dry Clothes Mode; Dehumidify Mode and Continuous Mode.

When powered on, press the "Mode" button, the device will display from the drying mode to dehumidifying mode and continuous dehumidifying mode.

Each time you press the mode button, the working mode will switch accordingly.

Dry Clothes Mode: Humidity and fan speed cannot be set.

Dehumidify Mode: Humidity and fan speed can be set.

Continuous Dehumidifying Mode: Humidity cannot be set, fan speed can be set.

### Humidity Setting

The humidity level can be set within a range of 30%RH to 80%RH in 5% increments.

-When it starts to work, it will first automatically detect and show the room's humidity. In dehumidification mode (other modes are invalid), press the "Dehumidify" button, you can change the humidity selection.

The "52" will flash and show the setting humidity, and you can set the humidity within a range of 30%RH to 80%RH by making the humidity setting increase by 5%RH. After no operation for 5S, "52" will show the actual room humidity.

-When the humidity level is higher or drops to the level you have set, the dehumidifier will automatically begin to work or stop.

-When the humidity level is set at 30%RH, the dehumidifier will be work at continuous dehumidifying mode.

# OPERATION INSTRUCTIONS

## Timer Setting

This TIMER setting function is designed for you to set a time to turn off or turn on the machine, automatically by the timer.

1. Press the "TIMER" button to select the timer by 1-hour increment. You can set the timer up to 24 hours. It will start to do the countdown when you start the timer.
2. Press and hold the "TIMER" button for several seconds to make the selection of the timer faster.
3. If the time is set to 00, this is called the invalid time. If you set the timer successfully, the light "  " will be on. The LED screen will show the remaining time if you press the "TIMER" button, and display the current humidity automatically after a few seconds.

## Speed Button

Control the fan speed. Press to select either High or Low fan speed. Higher fan speed will result in quicker moisture removal. Set the speed high for maximum moisture removal. When the humidity has been reduced and quiet operation is more preferred, set the fan speed back to Low.



## Light Function Settings

In the power on state, press the " Lighting " button to make the backlight on and press the button one more time to make the backlight off.

## Power Off Memory Function

1. The device automatically restores the working state after power on.
2. If the device is turned on and a power interruption occurred, after starting the unit again, it will keep the previous parameters that was set up.
3. If the device is turned off and power interruption occurred, the device will still be in a power off status when turned on.

## Overflow Protection

When the water tank is full of water, the machine will turn off automatically. The indicator light  will flash. After you empty the water from the tank, the indicator light  will turn off. The machine will restart to work.

# OPERATION INSTRUCTIONS

## Auto Defrost Function



When the dehumidifier is running at a lower temperature, the system will automatically determine whether there is a presence of frost. If any frost exists, it will defrost automatically.

## Defrost Action

The fan runs at high wind speed when the compressor stops, and the LED screen displays the defrosting symbol.

When defrosting status. the power button "O" will flash.

## 3. Display Status Description

- When the device is currently powered on, before any operation, only the "POWER" button light will be on indicating the device is in "Standby" Status.
- TIMER "  " : If the timer is set up properly. the indicator light will be up, flash if press TIMER button again to check and reset, and go out if non-successful setup.
- The lighting button "  " : If the lighting function has been turned on, the light will be on.
- High-speed indicator light " <sup>HIGH</sup> O " : If you set the unit to high speed fan mode. the indicator will light up.
- Low-speed indicator light " <sup>LOW</sup> O " : If you set the unit to low speed fan mode. the indicator will light up.
- Dry clothes indicator light " <sup>DRY</sup> O " : When dry clothes mode is selected, it will be on, otherwise it will be off.
- Dehumidification light " <sup>DEHU</sup> O " : When the machine starts to dehumidify, the indicator light will be on.
- Continuous dehumidification light " <sup>CONT.</sup> O " : When the continuous dehumidification mode is selected, the light will be on.
- Water full indicator light "  " : When the water tank is full, this indicator will flash.
- When the dehumidifier normally works, the "52" will show the current humidity.

## 4. Instructions for Drying Clothes

The dehumidifier can be used for drying clothes in rainy weather.

### Step 1.

Hang the washed clothes in a small space such as cloakroom, bathroom, or storage room.

Note: Keep away the unit from the water drips of the washed clothes.

### Step 2.

Open the dehumidifier and set the humidity level at 30%RH. It's the best if you let the airoutlet of the dehumidifier to blow air to the clothes directly.

1. The drying effect will vary from the thickness of clothes, the number of clothes and the size of the drying space. Theoretically, the effect will be better when clothes are few, thin and space is small.

2. The drying process would take 3-8 hours, and we suggest that continuous drainage mode would be more suitable when drying clothes.

## 5. Fault & Processing Methods

Fault Phenomenon	Analysis of Causes	Processing Method
Humidity always shows "25% RH" — but there is a big difference from the actual humidity.	Humidity sensor failure?	Set the humidity to 30%RH, the dehumidifier can still continue to work, and can be used normally.  Repair and replace the humidity sensor.
Humidity always shows "99% RH" — but there is a big difference from the actual humidity.	Water on the surface of humidity sensor?	The dehumidifier is not affected and can continue to work, and can be used normally.  Please let the dehumidifier keep working for a period of time, after the water on the surface of humidity sensor is removed, it will return to normal.  Repair and replace the humidity sensor.

If the malfunction is still present, please don't hesitate to contact Kesnos Customer Service email: [support@kesnos.com](mailto:support@kesnos.com) for help.

**Note:**

Before starting the machine, please ensure that the air outlet has been opened, otherwise the machine will overheat. Do not pull out the power cord directly to stop the machine.

## 6. Empty the Water Tank

Two ways are available to remove the collected water.

### Use the Water Tank

When the water tank is already full, the Full Tank Alert indicator will light up, the dehumidifier will automatically shut down until the tank has been emptied and placed back to the unit.

### Ways to Empty the Water Tank

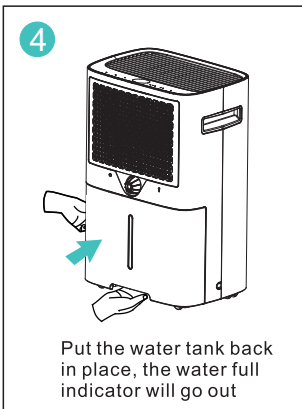
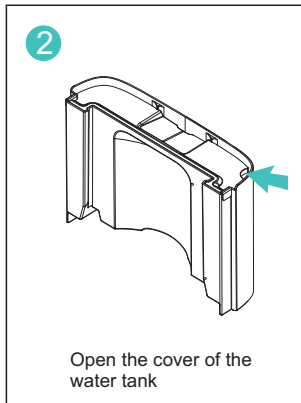
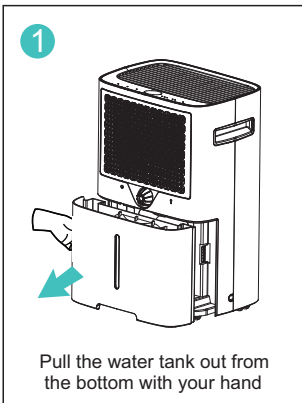

## OPERATION INSTRUCTIONS

### Note:

- Do not remove the float from the water tank. If the float in the water tank is removed, the sensor may not be able to determine the water level stored in the tank properly that may lead to water overflow leak from the water tank.
- If the water tank is dirty, just use cold water or warm water to clean it. Do not use detergent, steel wool, chemically treated dust cloth, gasoline, benzene, thinner or other solvents. Otherwise, it may damage the water tank and cause it to leak.
- When placing back the water tank, use your hands to press the tank back in its place. If the water tank is not placed properly, sensors or protections from water overflow may not operate as expected.

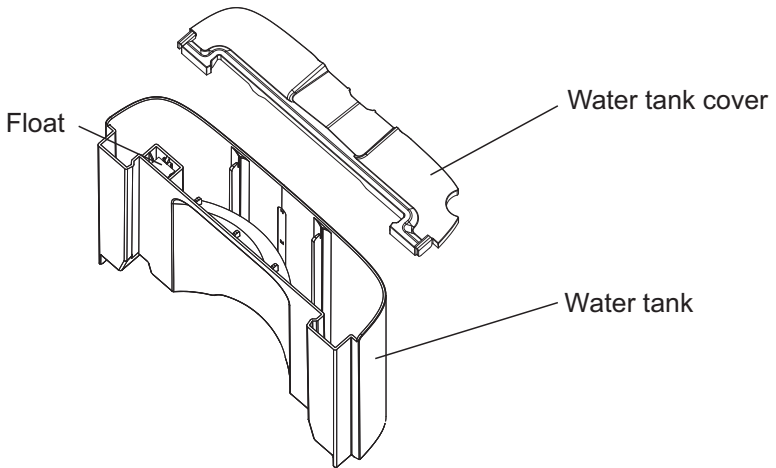



## 7. Continuous Drainage

Remove the power supply, take out the water tank, open the drainage cap, and remove the rubber plug, then insert the water hose into the continuous drainage port and put back the water tank. Connect the power supply to start the operation. The outlet of the water hose should be lower than the continuous drainage port by more than 3.9 inches, and can not be bent. (Note: The diameter of continuous drainage port is 0.63 inches.)

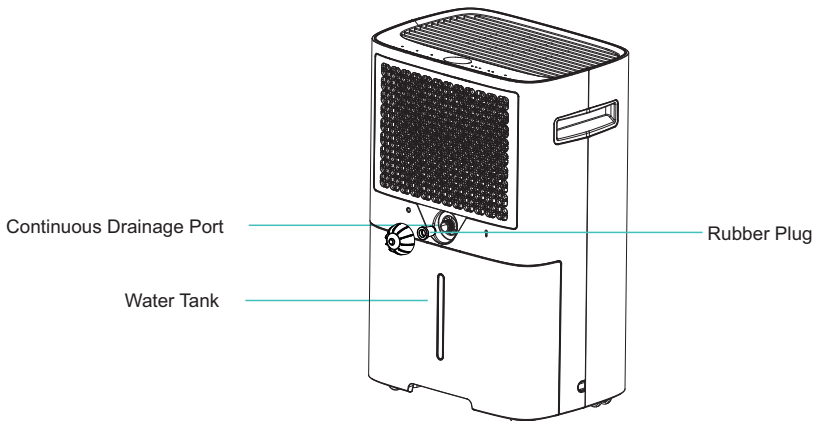
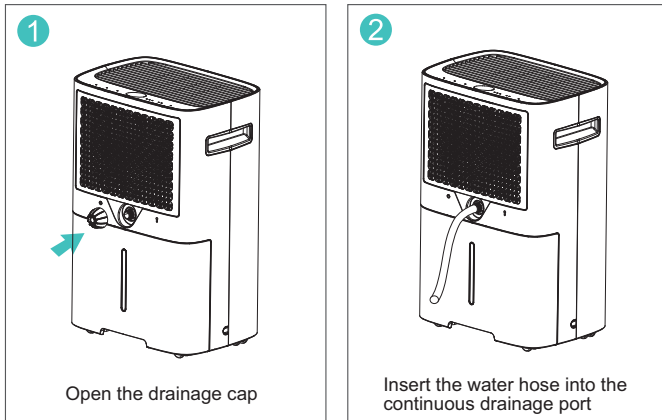

# CLEANING AND MAINTENANCE

## ⚠ WARNING:

Turn the dehumidifier off and remove the plug from the wall outlet before cleaning.

### A-Cleaning the dehumidifier body

Please use a soft and a slightly wet textile or cloth to clean it.

### B-Cleaning filter

- 1 Pull out the filter.
- 2 Clean the filter: Use a vacuum cleaner to gently remove the dust from the surface of the filter. If the filter very dirty, clean it with warm water and mild detergent and dry it completely.
- 3 Slowly insert the filter back into the machine body.

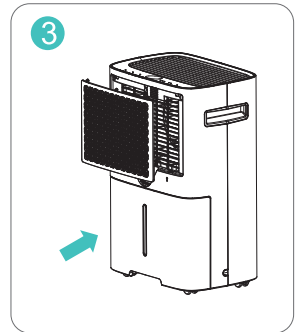
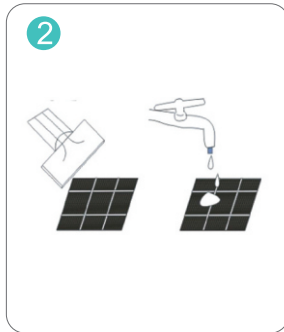
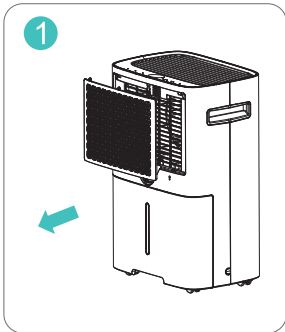

### C-Dehumidifier storage

When you want to store the dehumidifier because you don't use it for a long time. Please pay attention to the following steps:

1. Empty the water in the water tank.
2. Roll up the power cord and tie it up.
3. Clean the filter.
4. Place the machine in a cool and dry environment.

# TROUBLESHOOTING

Check the information below for troubleshooting steps, it will save you time to resolve issues that may happen with the unit. The list includes most of the common cases, but not the results of defective unit, crafts or materials in the unit. If all troubleshooting steps have been exhausted and the issue is still occurring, please feel free to reach out to Kesnos Customer Service to get further assistance.

Problem	Cause	Solution
Dehumidifier does not work	The power cord is unplugged.	Make sure that the unit's plug is inserted properly into the power outlet.
	Is the Full Tank indicator blinking? (The tank is full or in a wrong position. )	Empty the water in the water tank and then reposition the tank.
	Is the room temperature above 95°F (35°C) or below 41°F (5°C) ?	This product does not apply to over hot or cold environment, the machine will automatically enter the protection mode. It is a normal phenomenon.
	Is the room temperature between 41°F(5°C) and 68°F(20°C) ?	When running under lower ambient temperature, the machine will automatically defrost, which is a normal phenomenon. It will restart dehumidification again until the defrosting process finished.
	The dehumidifier is in the defrosting process.	It is normal the compressor ceases while defrosting process. Wait until the process finished, it will restart dehumidification again.
	Is the room humidity lower or reaching the preset humidity level?(When the room humidity has reached the preset level, the dehumidifier will enter Standby Mode and the indicator on LCD will flash. )	Please set the humidity decrease by 5% than the room humidity or set the humidity to 30%.

# TROUBLESHOOTING

	This is to prevent the frequent start of the machine. Does the machine stop working just now?	Please wait for more than 3 minutes.
	Room humidity is low.	The dehumidifier is designed to work in the humidity range of 30%-80%. Above or below this range, it will not work.
Dehumidifier does not dry the air as it should	The air filter is dirty.	Clean the air filter.
	Is the air inlet or air outlet obstructed?	Remove the obstruction from the air inlet or outlet.
	The dehumidifier size is too small for application.	Increase the quantity of dehumidifier. Or change a higher capacity dehumidifier.
	Poor air circulation.	Please leave about 7.9 inch (20cm) around the product.
	Did not allow enough time to remove the moisture.	Allow enough time to remove the moisture. When first installed, allow at least 3-4 days to maintain the desired RH.
	The room has not been sealed properly.	Check that all doors, windows and other openings are securely closed.
	The air filter is clogged.	Wash the filter.
	Room temperature is too low, or below 41°F (5°C): The machine will not work or undergo poor dehumidifying efficiency in low temperature.	Please wait until the temperature rises to above 5°C or higher.

# TROUBLESHOOTING

The dehumidifier makes loud noise when operating	The dehumidifier is not positioned levelly.	Move the machine to a horizontal position.
	Is there blocking around the air inlet? The air filter is clogged.	Clean up the dirt or lint on the air outlet and intake.
	Is the filter installed correctly?	Please check whether the packing bag of the filter had been removed and the filter has been installed correctly.
Dehumidifier operates continuously	Check if the dehumidifier is in Continuous Mode.	Do Not set the humidity too low. Typically, 40-50% are good for use.
	Room humidity is too high.	Change humidity setting. Or change to a higher capacity dehumidifier.
	Doors and windows are open.	Ensure that all doors, windows and other openings are closed.
Overflow of water on floor	The float of water tank has been stuck.	Move the float and let it swing freely.
	The magnet on the float has come off.	Put the magnet in right position.
	Hose to connector or hose connection may be loose.	Connect the hose with the drainage port tightly.
	The water tank has not been installed properly.	Re-install the water tank properly.

If the dehumidifier is still not working properly as expected and the troubleshooting steps or solutions above may not resolve the issue.

Please unplug the power and shut down the dehumidifier, then contact Kesnos Customer Service at [support@kesnos.com](mailto:support@kesnos.com).

# SPECIAL NOTES



1. When using, please do not put the machine at the soft and uneven ground, avoid vibration and movement.

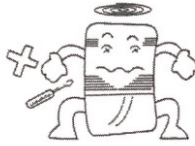

2. Do not insert thin rods and hard objects into the machine body to avoid malfunction and danger.

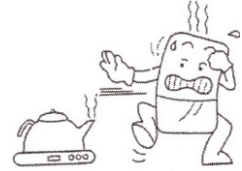

3. When using, please keep the machine away from heating furnace, electric kettle and other heat sources.



4. When using, make sure doors and windows are closed to get the best humidity removal effect.

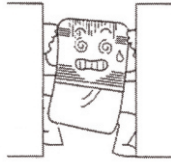

5. Please do not put objects around the body. If the ventilation is blocked, the dehumidification effect will be affected.



6. If do not use the product for a long time, please unplug the power cord.



7. When cleaning the dehumidifier, please use the wet textile to wipe gently, do not shoot the water directly.



8. Please do not put any object on the dehumidifier.



9. Please clean the filter every two weeks (do not use hot water above 104°F, alcohol, gasoline or toluene.).

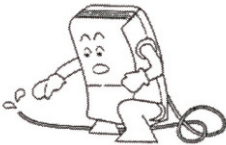

10. When continuous drainage, the drainage hose must be placed horizontally, without unevenness and winding.



11. After cleaning the filter, please do not dry it under direct sunlight, in case deformation.



12. Before moving and carrying the machine, please first pour out the water in the tank.

# TECHNICAL PARAMETERS

MODEL	PD08A-18
POWER SOURCE	120V ~ 60Hz
RATED POWER(95°F,90%RH)	400W
RATED CURRENT(95°F,90%RH)	3.6A
MOISTURE REMOVAL(65°F,60%RH)	15 Pints/Day(7.13L/Day)
MOISTURE REMOVAL(80 °F,60%RH)	23 Pints/Day(10.88L/Day)
MOISTURE REMOVAL(86 °F,80%RH)	40 Pints/Day(18.9L/Day)
MOISTURE REMOVAL(95 °F,90%RH)	50 Pints/Day(23.7L/Day)
INPUT POWER(65°F,60%RH)	216W
INPUT CURRENT(65°F,60%RH)	2.0A
IEF( 65°F,60%RH)	1.30 liters/kWh
MOTOR FLA	0.23A
MOTOR COMPRESSOR	RLA:4.3A LRA:9.9A
REFRIGERANT	R134a/5.29ozs(150g)
MAXIMUM ALLOWABLE PRESSURE	363PSIG(2.5MPa)
HIGH PRESSURE	232PSIG(1.6MPa)
LOW PRESSURE	90PSIG(0.62MPa)

 WARNING:

This product can expose you to chemicals including Styrene and its compounds, which is known to the State of California to cause cancer and birth defects or other reproductive harm. For more information go to: [www.P65Warnings.ca.gov](http://www.P65Warnings.ca.gov).

### Warranty

---

Kesnos offers a 12-month warranty to all of our products together with the original proof of purchase when a defect occurred, including those newly purchased and unused, from Kesnos or through an authorized reseller, wholly or substantially, or as a result of faulty manufacturing parts, or workmanship during the Warranty Period.

The warranty does not apply if damage is caused by other factors, including but without limitation of:

- (a) Normal wear and tear;
- (b) Abuse, mishandling, accident or failure to follow operating instructions;
- (c) Exposure to liquid or infiltration of foreign particles;
- (d) Servicing or modification of the product other than by Kesnos.

There are our general terms for the warranty service, but we always encourage our customers to contact us if any issues, regardless of warranty terms. If you are experiencing an issue with Kesnos product, you can reach out to us at [support@kesnos.com](mailto:support@kesnos.com), we will dedicate our efforts to resolve it for you. )

### Extend Your Warranty by 1 Year

---

Register your product at [www.kesnos.com](http://www.kesnos.com) to extend your 1-year warranty by an additional year.

\*Please fill out all required fields and include your Order ID, Date of Purchased if applicable.

### Customer Support

---

If you have any questions or concerns about your product, please feel free to contact our expert support team. Kesnos customer service is here to help.

#### **Kesnos Office**

13211, Spring Street Baldwin Park, CA, US

Email: [support@kesnos.com](mailto:support@kesnos.com)

Live Chat: [www.kesnos.com](http://www.kesnos.com)

#### **Support Hours**

24 Hours available

\*Please have your Order Number ready before contacting customer support.





# KESNOS

For FAQs and more information please visit:

[www.kenos.com](http://www.kenos.com)



@Kesos



@Kesos



@Kesos



@Kesos



(Scan the QR Code for Live Chat)

We are expecting to see our products fulfill your life and hear your voice.

Your satisfaction means a lot to us.

Please tag us if you share a snap on your social media.

[www.kenos.com](http://www.kenos.com)