

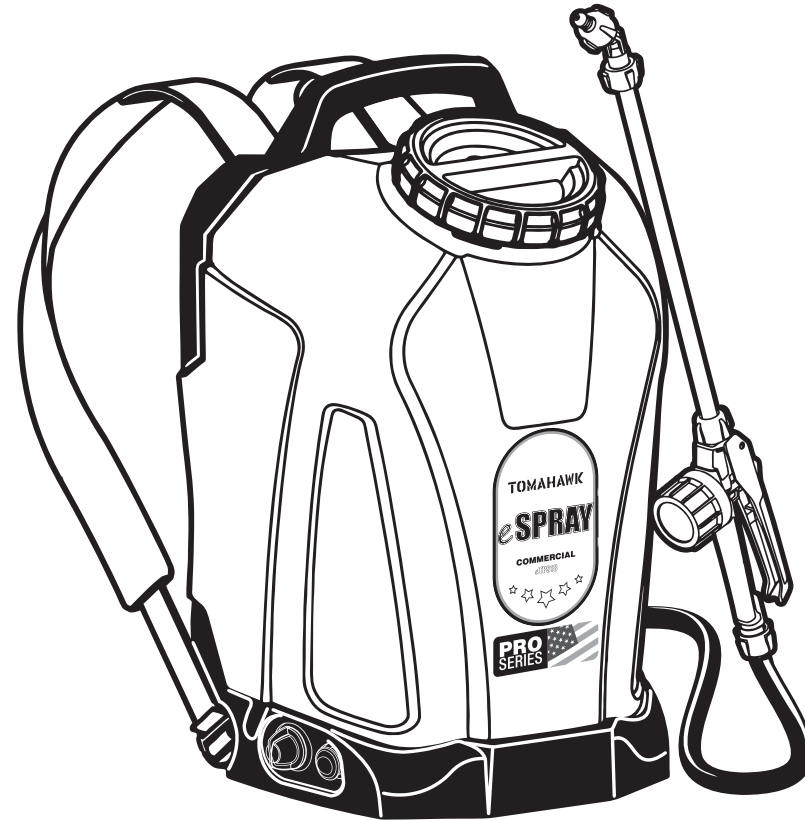

# TOMAHAWK

OPERATIONS MANUAL  
18 Liter Battery Power Backpack Sprayer







## OUR STORY |

In 2012, Tomahawk Power was founded with a simple mission: build the best tool for the job and deliver the best customer support. Tomahawk builds tools that can be used every day and will stand the test of time for the professional contractor, tradesman, and handyman. No more single-serve disposable tools; we are here to deliver quality, American made tools and equipment. Designed with the help of contractors nationwide, Tomahawk Power manufactures its products with the most durable, high quality components available.

Tomahawk's commitment to American engineering through constant research and design, along with invaluable customer feedback, helps us achieve superior equipment performance. With long lasting parts and engines, Tomahawk equipment will be the star of your fleet for years to come.

From checkout to your job-site, Tomahawk is on call to answer questions, provide tips, and supply quality service. Gain access to faster spare parts

availability, nationwide repair centers, and a comprehensive library of manuals, assembly guides, videos, & more.

Tomahawk understands to keep a job-site running smoothly, the proper equipment and spare parts are needed at the drop of a hat. With same day shipping and faster delivery times, count on Tomahawk to help reduce your job-site down time and get you back to work.

Today, Tomahawk Power manufactures outdoor power sprayers, light construction, and portable power equipment. Our priority is to service our customers by offering same day shipping, technical equipment support, and an industry leading commercial grade product warranty. Tomahawk Power has service centers throughout North America and national partnerships with major small engine manufactures including Honda.

**POWER YOUR WORLD!**

## FORWARD THINKING |

Ever-evolving, Tomahawk aims to be one step ahead in green energy, equipment performance, user comfort, customer experience, and more. Through our commitment and experience, we strive to establish a lifelong relationship with customers worldwide.

## APPLICATION AND USE OF YOUR SPRAYER |

Offering adjustable pressure from 5-60 PSI, Tomahawk's PRO SERIES Battery Backpack Sprayers are perfect for pest control professionals treating residential and commercial areas! Larger for extended use, fill the sprayer's 18 liter chemical tank with your ideal liquid pesticide, herbicide, or fertilizer! Spray faster with this sprayer's adjustable nozzled to combat insects in hard to reach places! Achieve the ultimate comfort in pest control with adjustable straps with layered padding, to reduce operator fatigue.

Perfect for water-based disinfectants and sanitizers, spray around your own home or business to eliminate germs and kill 99.9% of viruses, bacteria, and fungi to help stop the spread of cold & flu viruses!



## INDEX

	Página
HOW TO USE THIS MANUAL	6
STORAGE AND RECYCLING	6
SYMBOLS	6
EQUIPMENT AND FEATURES	7
SAFETY AND HANDLING	7
USER AND OPERATOR RECOMMENDATIONS	9
CLOTHING AND PROTECTIVE GEAR	9
YOUR SPRAYER WARNINGS	9
BOX CONTENTS	10
SPRAYER USE	11
PREPARING YOUR SPRAYER	12
SPRAYER ASSEMBLY	13
OPERATING THE SPRAYER	17
CLEANING AND STORAGE	20
PRESSURE ADJUSTMENT	23
FUSE REPLACEMENT	24
SPRAYER HOSE	26
PARTS LIST	28
MAINTENANCE SCHEDULE	32
TROUBLESHOOTING	32
TECHNICAL SPECIFICATIONS	36
GOOD USE PRACTICES	37
WARRANTY	37



## HOW TO USE THIS MANUAL

This manual contains operational instructions for the eTPS18 Backpack Sprayer. It has additional information that requires attention. Symbols are used to draw attention for information that is critical.



## STORAGE AND RECYCLING

- Keep original box in case you need to transport the sprayer. If you do not need the box, discard it in accordance to its residue type. The carton box can be recycled.
- Once the sprayer is no longer operational, the unit should be scrapped according to local legislation.
- Battery and charger should not be thrown away with domestic trash, it should be discarded in an authorized dangerous residue recycling center.
- If you plan on storing your sprayer for a long period of time, make sure that the battery is fully charged and charge at least once per month.
- Store battery and charger in a dry area.

- Do not store the battery in places where there is static electricity.
- Never store the battery in a metal case.

## SYMBOLS



Risk of injury, risk to other or property damage.



Sprayer damage risk or of its components.



Harmful to the environment.

Failure to comply with these instructions automatically eliminates the sprayer's warranty.





## EQUIPMENT AND FEATURES

This manual contains operational instructions for the Tomahawk eTPS18 sprayer.

## SAFETY AND HANDLING



One of the many uses of the sprayer involves the use of chemicals, therefore it is necessary to take proper precautions to reduce the risk of bodily injury.



It is important that you read, understand and practice the recommendations included in this manual.



Most accidents occur while filling the sprayer or mixing pesticides. Resulting injuries can be serious, such as temporary or permanent blindness and/or risk of serious burns.



When using chemicals follow the process below:



Read product label. If it recommends the use of protective goggles or not.



Use the appropriate nozzles to avoid harm to others



Never spray against the direction of the wind.



If the products you are using are toxic, make sure you are wearing protective clothing.



If possible, use the sprayer for agrochemicals only. The mixture of some of the products could cause a chemical reaction producing toxic emissions, or an explosion.



Always make sure that the pesticides you are using are compatible.



Make sure to discard empty bottles and excess pesticides using manufacturers recommendations. Protecting the environment is everyone's responsibility.



When rinsing the sprayer, do not discard liquids near a natural water source.



Do not allow children to operate the sprayer.



Keep animals away from the areas you are spraying.



In order to obtain maximum performance, it is always important that the operator (s) of the sprayer understand the instruction manual and takes proper precaution.



Before performing maintenance, always make sure that the sprayer is turned off, and the battery has been removed.



Never spray with flammable chemicals.



Do not use sprayer in the rain.



### USER AND OPERATOR RECOMMENDATIONS

- If you have arm, back or shoulder injuries, and you are planning to use the sprayer, consult with your medical provider first.
- Do not operate the sprayer under the influence of alcohol, recreational or prescription drugs that may impair your judgement.

### CLOTHING AND PROTECTIVE GEAR

To reduce the risk of injury, remember to follow these recommendations:

- Always use adequate clothing and protective gear.
- While using chemicals, or cleaning the sprayer, always make sure to follow manufacturers recommendations.

- Use protective goggles.
- Use chemical-resistant gloves and rubber boots.
- If you are planning on operating the sprayer inside a greenhouse, make sure the site is adequately ventilated.
- Always read safety instructions carefully and follow recommendations.

### YOUR SPRAYER

- Do not make any modifications to your sprayer.
- Do not use accessories that are not compatible with this model.
- Do not use the sprayer for other purposes. Before each use, verify that the unit is functioning.
- Do not use liquids with temperatures higher than 86 degrees F.

### BOX CONTENTS

Inside the sprayer box you will find the following parts

A. Tank, straps, battery, and outlet hose.

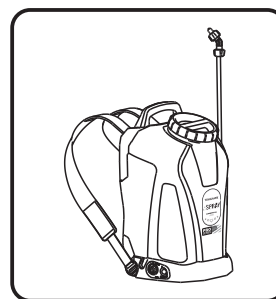

B. Nozzles

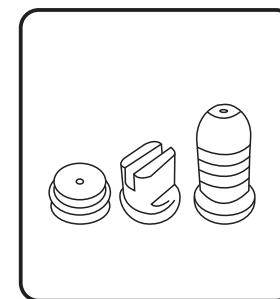

C. Brass Wand

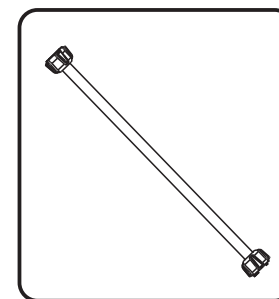

D. Charger

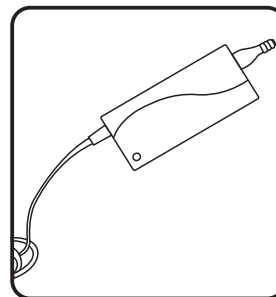

E. Instruction Manual

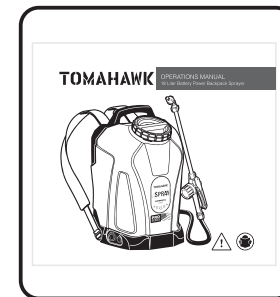



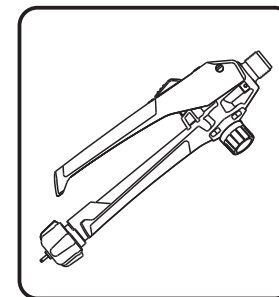



F. Handle and Pressure Gauge





## SPRAYER USE

-  Never operate the sprayer if it's not assembled correctly, or if it is damaged. Carefully inspect the unit to make sure it doesn't have any leaks and verify that the wand operates accordingly.
-  Verify that the battery is installed correctly before use.
-  The sprayer is designed to be used with a wide variety of agrochemicals, pesticides, cleaning agents and many other solutions.
-  Do not use caustic or corrosive solutions.
-  Verify that the harness is adjusted securely before using the sprayer.
-  Never point the wand towards humans or animals, even if the sprayer is not being used.
-  Do not use the sprayer when there is presence of wind, this could potentially harm others. The pump filter should always be installed inside the sprayer. The filter protects the pump from suctioning unwanted particles, that could damage the functionality of the sprayer.

## PREPARING YOUR SPRAYER

### Charging the Battery

Always charge the battery for a minimum of 8 hours (overnight) before each use.

1. To retrieve the battery, unfasten the locks and pull outward.

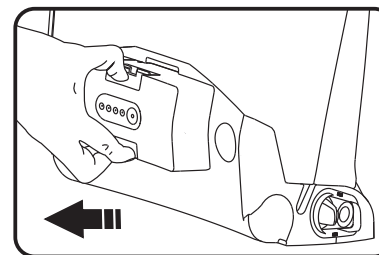

2. Remove security strip.

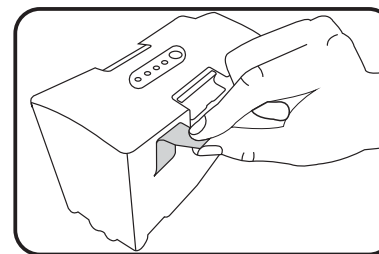

3. Connect the battery to the charger. Do not use a different charger, doing so could damage the battery.

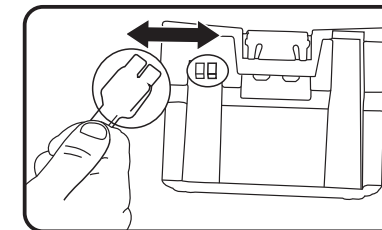

4. Connect the charger to the wall outlet.
5. Verify that the battery is charging by looking at the LED indicator. If the LED is red, it indicates that the battery is charging correctly. Once the LED is green, the battery is fully charged.

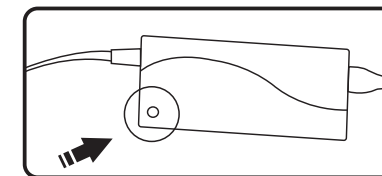

6. Disconnect the charger from the wall outlet. Do not pull the cable, as this could cause damage.



## SPRAYER ASSEMBLY

Once you have identified each part of the sprayer, you can begin assembly, by following these instructions:

### Assembly of wand and nozzle

1. Carefully screw the wand to the handle and tighten.

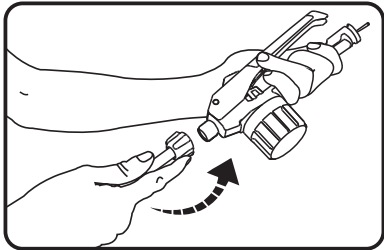

2. Install the nozzle on the wand.

Installation in order: screw, nozzle holder, nozzle and washer.

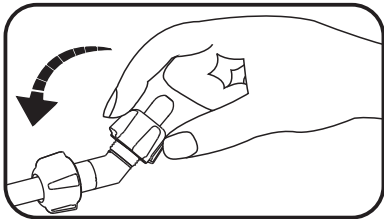

## Adjusting the straps

1. Adjust the straps according to your height, making sure that the sprayer is against your back.



1.1 One strap loose and the other adjusted at a comfortable level.

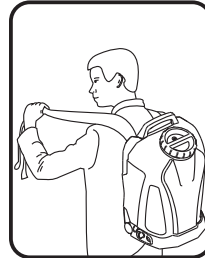

1.2 Adjust the strap over your shoulder, and then adjust the strap holder in the lower chassis, you should hear a "click" sound.



## IMPORTANT!

The strap holder will allow you to adjust the straps when needed and loosen them when it's quickly needed.

1.3 Once you have placed the backpack sprayer on, tighten the straps by pulling them down.

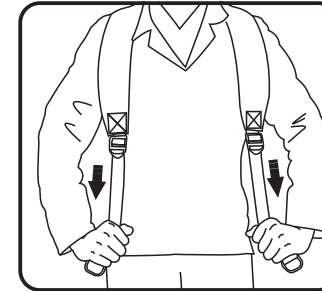

## Battery Installation

1. Verify that the on/off switch is in "off" position, and that the knob is situated at the "MIN" level.

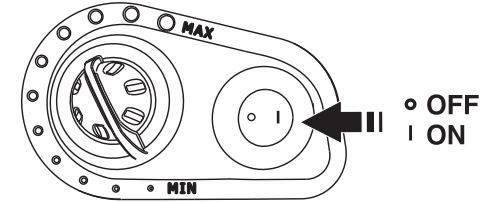

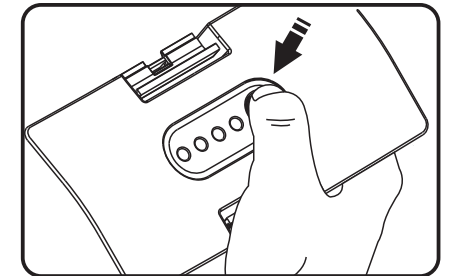

2. Verify the battery charge level. To do so, press the front button of the battery.

- Four LEDs lit (Green, Green, Yellow, Red) indicates that the charge is between 90% and 100%.
- Three LEDs lit (Green, Yellow, Red) indicates that the charge is between 40% and 90%.
- Two LEDs lit (Yellow, Red) indicates that the charge is between 40% and 10%.
- One LED lit (red) indicates that the charge is less than 10%. In this case, fully charge the battery.





 Charge your battery periodically (every 30 days) to avoid deterioration due to low levels of charge.

 Never store your battery without charge

 If the battery loses charge completely during use, make sure you re-charge it before storing it.

**3.** Install the battery in the bottom part of the sprayer, making sure that the red and black connectors are facing down. Press the battery, until you hear a “click” sound, this indicated that the battery has been installed successfully.

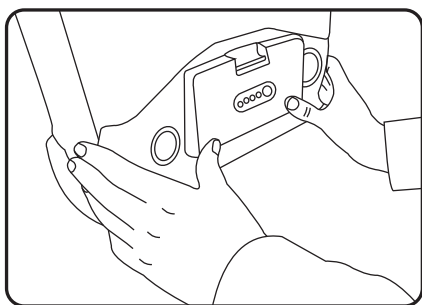



**4.** To verify that the battery has been installed correctly, power on (empty tank) by turning the knob, the engine will start working. Turn the sprayer off.

### Filling the Tank

#### Recommendations

 Always make sure you place the sprayer on a flat surface.

 The fill filter should always be installed on the opening of the tank. The filter protects the sprayer from suctioning residues that might harm the sprayer. Once you are done filling the tank, make sure that any spillage on the outside is fully cleaned off and dried.

 The high-quality straps can absorb some liquid.

 While using soluble powder, make sure the premix is done in a different container, following manufacturer's instructions. Using excessive amounts of soluble powder, will produce an elevated concentration of solids, which can damage the tank. (Example: copper sulphate)

 Do not use wet powder, as this is not easily dissolved and requires constant agitation to maintain the suspension. The sprayer does not agitate the contents inside the tank. (Example: copper oxychloride). Solid particles will settle and damage the sprayer.

 The maximum temperature for liquids is 86 F.

 Never use the sprayer for pesticides, if it has previously been used for herbicides. To do so, you must wash the sprayer and rinse it with a neutralizer for herbicides, following manufacturer's instructions. Not doing so could burn plants.

### Test Run

 It is highly recommended to perform an operational test before using the sprayer for the first time. You can do so by using 4 liters of clean water, this will help verify that all the components are installed correctly and that the sprayer is functioning.

While performing the test run, if you encounter a problem with the sprayer, refer to “Troubleshooting” chapter.

**1.** Place the sprayer in front of you, with the back pad facing the opposite side. This will help avoid any spillage in the area where the battery and the straps are located

**2.** If spillage occurs, fully dry the area. If spillage occurs in the area where the battery is located, make sure it's fully dried including battery support system and terminals.

**3.** Once the tank is full, make sure the lid is securely sealed.



## OPERATING THE SPRAYER

### Handle

1. Handle without blockage
  - 1.1 Slide the latch onto the hose
  - 1.2 Operate the key freely

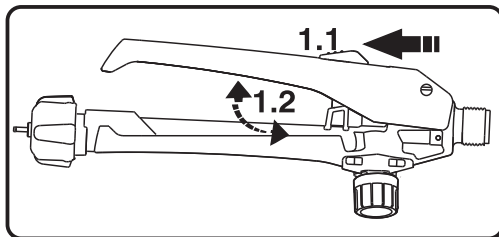

2. Handle with blockage
  - 2.1 Fully turn the key
  - 2.2 Slide the latch toward the nozzle

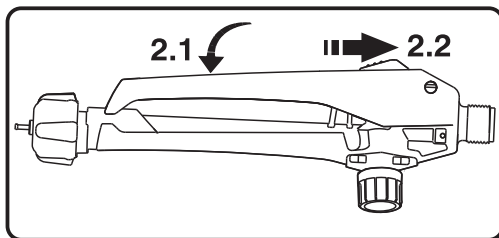

3. Close the handle with blockage
  - 3.1 Fully release the key
  - 3.2 Slide the latch toward the nozzle

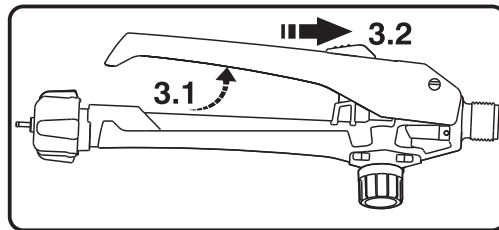

## SPRAYING

1. Place the sprayer on a flat and leveled surface
2. Remove the lid by turning it counterclockwise.

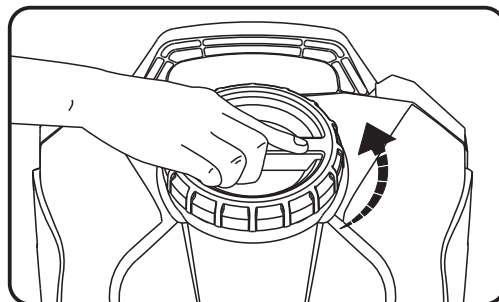

3. Verify that all the filters are installed correctly. (tank filter, stopcock filter and pump filter).



Liquid travels through three different filters which prevent pump and nozzle obstructions. Removing these filters can cause operation failures.



The pump filter should always be installed inside the sprayer. The filter will protect the pump from suctioning residues that will harm the sprayer.

4. Pour liquids inside the container. Avoid any type of spillage that could harm the user and sprayer components. If a spill does occur, take a piece of cloth and clean the area until it is completely dry.



5. Close the lid by turning it clockwise.

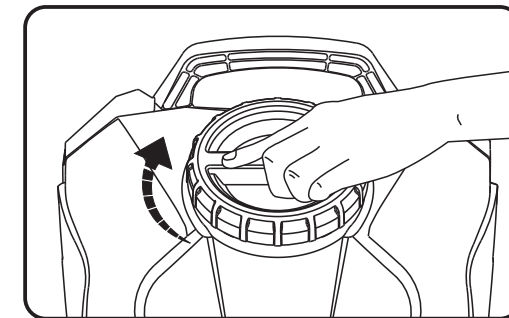

6. Place the sprayer on your back. when necessary, adjust the straps.

7. Power On

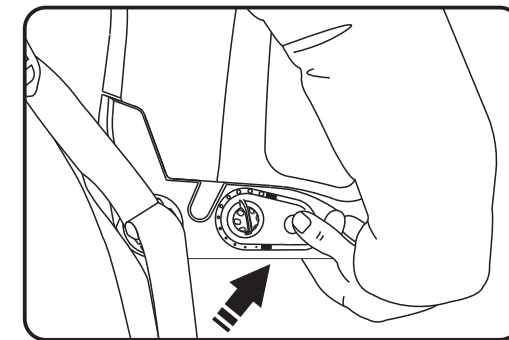



8. Point the nozzle in a safe direction and operate the stopcock.

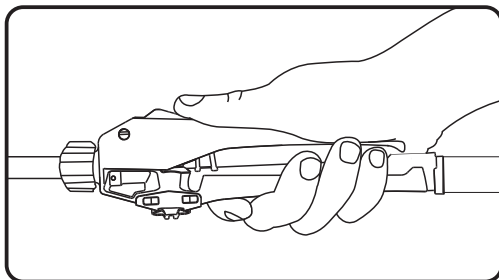

9. Depending on the installed nozzle, turn the knob to select the discharge setting.

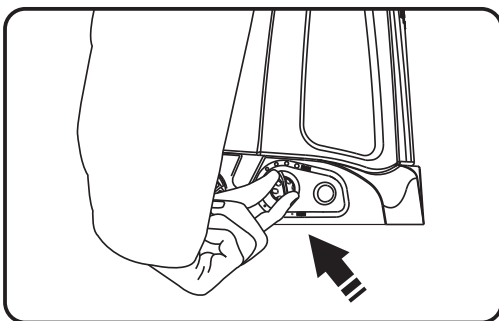

10. Place the stopcock in “closed position”

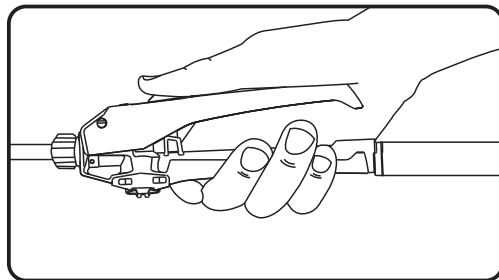

11. Release the stopcock y apply the desired dosage.

12. Once you have completed the job, follow with the cleaning process mentioned in “Cleaning and Storage.”

## CLEANING AND STORAGE OF THE SPRAYER

1. Once you have completed a job, discard the excess chemicals according to the guidelines provided by the manufacturer, taking into consideration local environmental protection rules.

2. Clean the inside of tank and rinse with plenty of water.

3. Clean the whole system.

- Install the tank filter
- Fill the tank with approximately 1 gallon of clean water
- Switch power on
- Point the nozzle out of harm's way and spray, use all the water
- Switch the power off, and turn the knob to the min position
- Eliminate pressure build up by grasping the lever several times

4. Remove the battery by pressing the locks and pulling outward. If the battery will be stored for a long period of time, make sure it is charged over 40%.

5. Clean Filters

6. Allow the sprayer to without the lid.

7. Install filters and place the lid on.

8. The sprayer, battery and recharge station

should be stored in a dry and ventilated place, protected against extreme environmental conditions.

### Cleaning the Filters



Liquid travels through three different filters which prevent pump and nozzle obstructions. Removing these filters can cause operation failures.



Never handle the filters when chemicals are being used. Before you remove the filters for cleaning purposes, make sure you have cleaned the sprayer following the guidelines mentioned earlier in this chapter.





### Container Filter

1. Remove the filter in the mouth of the sprayer's tank

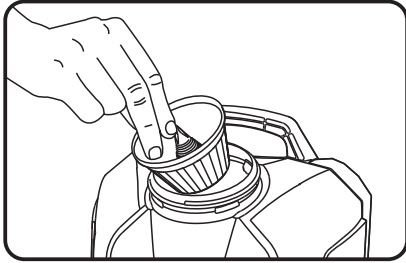

2. Add plenty of water in the opposite side of where particles are located

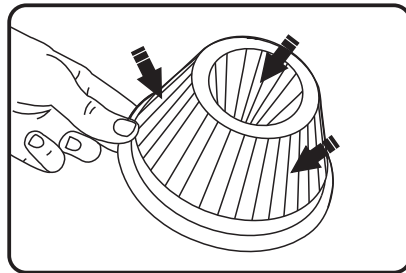

3. Reinstall the filter

### Pump Filter

1. Gently remove the tank filter.

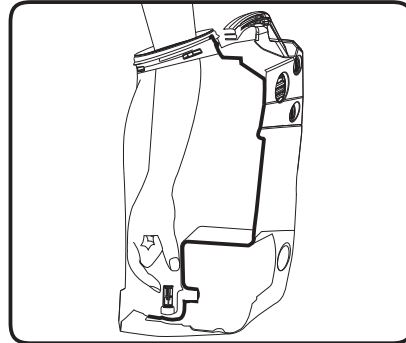

 Always use protective gear to prevent health hazards.

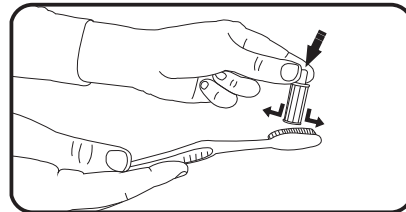

2. Allow water to run through the filter. If you need to remove debris from the filter, use a soft brush to eliminate.

3. Install tank filter by pressing and adjusting if necessary.

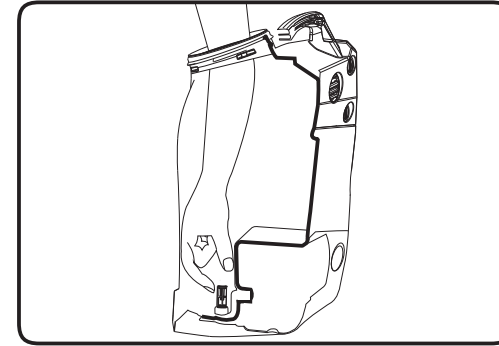

### Valve Filter

1. Remove the hose from the valve by twisting it counterclockwise.

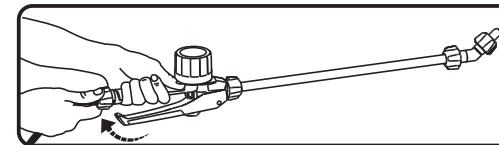

2. Gently pull valve filter.

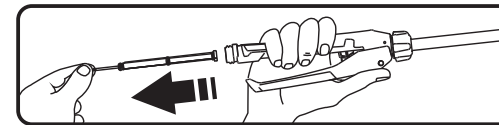

3. Allow water to run through the filter. If you need to remove debris from the filter, use a soft brush to eliminate.

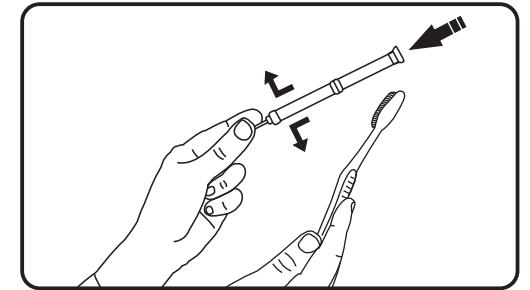

4. Install filter by pressing it on the valve.

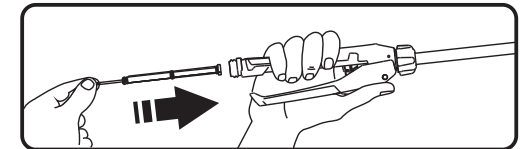

5. Reinstall hose by turning clockwise.

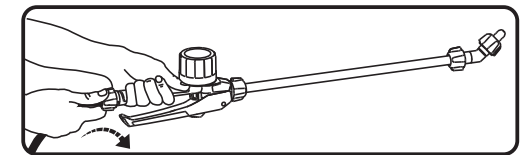





## PRESSURE ADJUSTMENT Calibration

The sprayer is designed to be used with different nozzles and pressure levels. Depending on the nozzle you selected, you can adjust discharge amounts by turning the knob to the desired discharge volume.

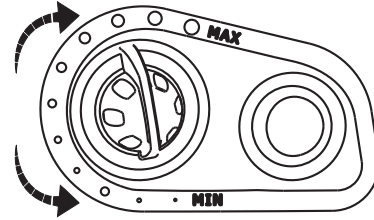

Reference	Drop	Pressure (Bar)	Pressure (PSI)	Flow cc/min	Type of Spray	Application
<b>WR110015</b>	Fine	2	29	490	Flat	Herbicide
	Very Fine	3	43	600		
	Very Fine	5	72	770		
<b>HC-01</b>	Very Fine	2	29	330	Conical	Folilage
	Very Fine	3	43	400		
	Very Fine	5	72	520		
<b>RC-350A151</b>	Fine	2	29	740	Conical	Folilage
	Very Fine	3	43	880		
	Very Fine	5	72	1140		

Use the pressure gauge to adjust it to the desired discharge.

## FUSE REPLACEMENT

Do not replace fuse while the tank is full.

1. Switch off

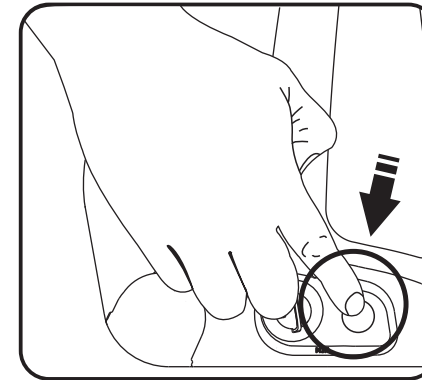

2. Remove the battery by firmly pressing on the safety locks.

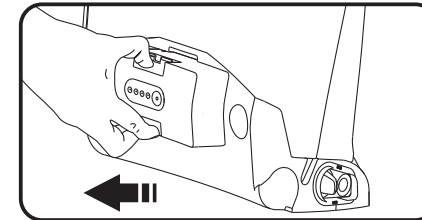

3. The fuse holder can be located on the bottom right, pull out without pulling cables.

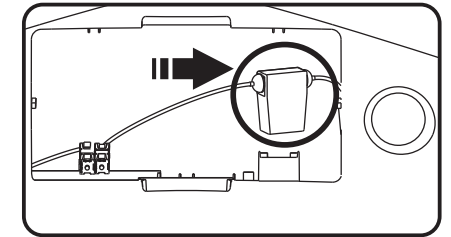

4. Open fuse holder by pulling the top portion.

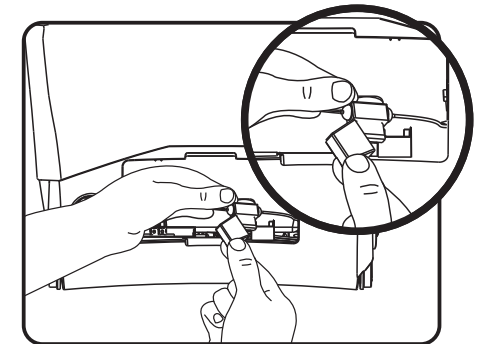



5. Remove fuse.

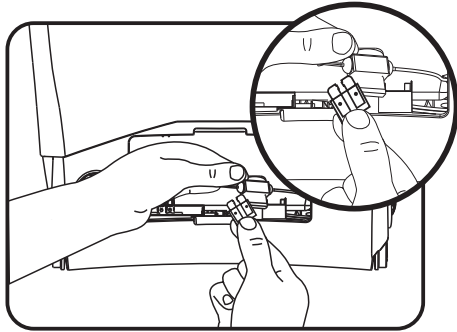

6. Look for rust traces that isolate fuse terminals.

7. Make sure the internal filament is not cracked.

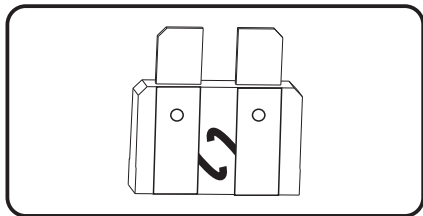

8. Install a new fuse if you notice rust or cracks.

9. Insert the fuse holder in its place, making sure that there aren't any exposed cables.

10. Place the battery in the lower chassis so that the connectors (red and black) are facing down. While holding the sprayer, push the battery

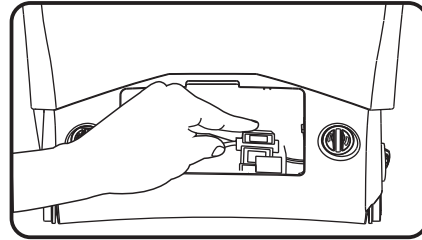

down until you hear a “click” sound that confirms the battery has been installed correctly.

11. The battery should align with the lower chassis.

 To ensure that the fuse has been installed correctly, power on. You should

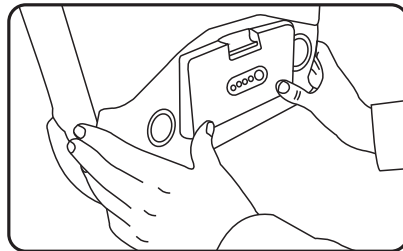

be able to hear the engine running. Power off.

### SPRAYER HOSE (RIGHT-HANDED LEFT HANDED)

The sprayer has two options to situate the hose output, left or right side.

 When performing this procedure, the sprayer should be in “storage mode” with an empty tank.

1. Remove the battery by pressing the locks.

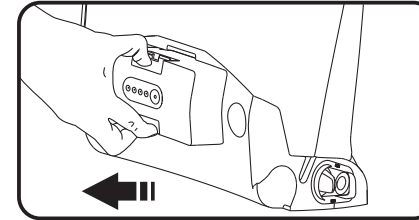

2. Remove the filter cover by pulling it. You can locate it in the bottom portion of the sprayer.

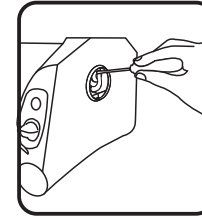
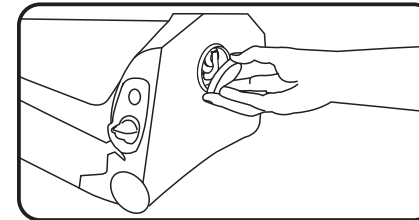

3. Using a spade screwdriver, remove the output connector from the container.

 Be careful, you can damage the output connector.

4. Using a coin, remove the screws that secure the bottom chassis of the container.

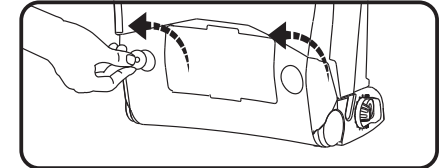

5. To remove the bottom chassis of the container, pull outward to unfasten the container.

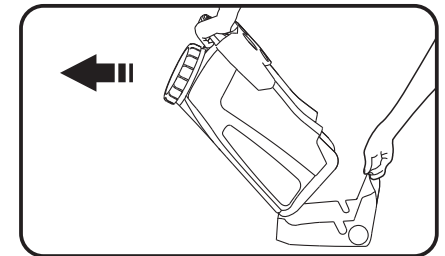



6. Move the hose to the desired location by twisting the elbow that connects the pump (there is no need to remove the clamps. Be extremely careful with the nearby cables).

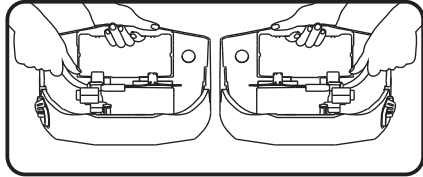

7. Place the tank over the lower chassis and install the screws with a coin.

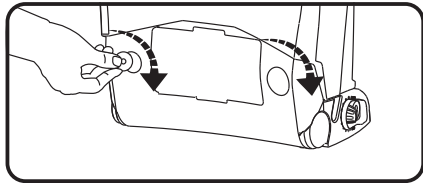

8. Attach the output connector by pressing on the tank.

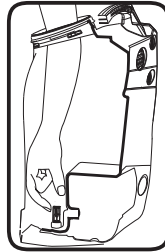
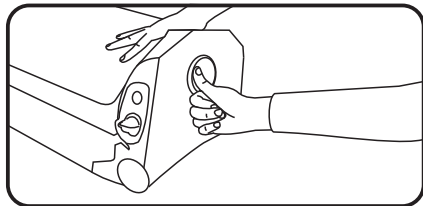

9. Insert filter holder inside the tank by pressing over the output connector and adjust. Using your other hand, hold the output connector to avoid disassembly.

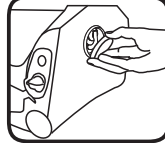

10. Install the connector filter cover by pressing on the lower chassis.

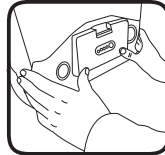

11. Place the battery in the lower chassis so that the connectors (red and black) are facing down. While holding the sprayer, push the battery down until you hear a "click" sound that confirms the battery has been installed correctly.

### SPRAYER TRANSPORTATION

- Make sure the sprayer is powered off while transporting.
- While transporting, make sure the sprayer is in an upward position, and protect the hose from sharp objects.
- If the sprayer is laid down horizontally, there is a possibility that its contents will leak through lid's vent valve.
- Never transport the sprayer laying on its side.
- Never transport the sprayer with dangerous chemicals inside.

### PARTS LIST

#### Battery Sprayer

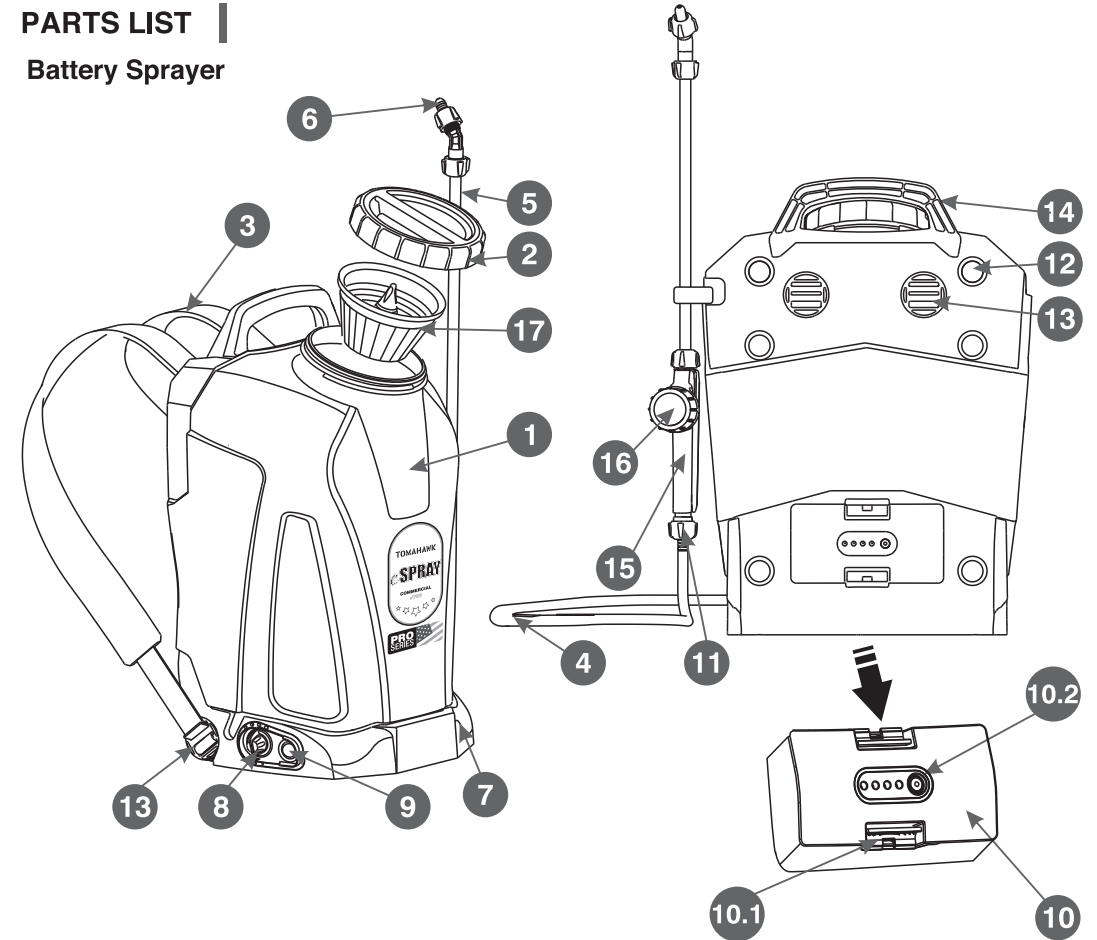



**Lower Chasis**

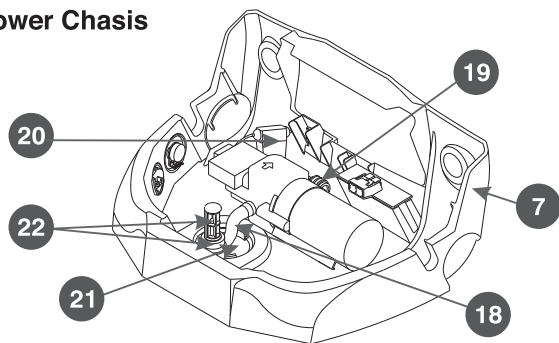

**Handle**

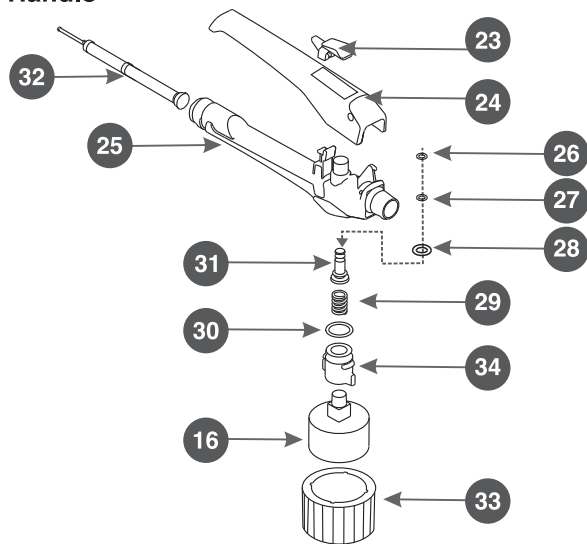

No.	Item
1.	Tank
2.	Tank lid
3.	Straps
4.	Hose
5.	Wand
6.	Nozzle
7.	Lower chassis
8.	Knob
9.	Switch
10.	Battery
10.1	Battery lock
10.2	Indicator button
11.	Hose nut
12.	Screws
13.	Strap holder
14.	Upper chassis
15.	Valve
16.	Pressure gauge
17.	Tank filter
18.	Output connector
19.	Pump outlet elbow
20.	Fuse holder
21.	Output connector lid
22.	Filter and filter holder
23.	Lock
24.	Handle
25.	Key
26.	O'ring RC-352
27.	O'ring RC-352
28.	O'ring RC-EC06
29.	Spring
30.	O'ring RM-106
31.	Stem
32.	Mesh key filter
33.	Pressure gauge protector
34.	Lid

**PARTS LIST**

N°	PART	DESCRIPTION	SPARE PART
1	Tank	18 Liter Tank	TMK-200-18X
2	Tank Lid	Red Tank Lid	TMK-202X
		Diaphragm Ventilation	
		Gasket container lid	
3	Straps	Padded Straps	TMK-700EX
4	Hose	Hose Assembly	TMK-305X
		Hose nut	
		1/4 hose fitting	
		Oring RC-124	
		1/4 spine coupling	
		Stainless steel clamp	
5	Wand	Wand Assembly	TMK-347EX-INX
		Plastic nut	
		Trapezoidal packing	
8	Knob	Knob	TMK-622X
10	Battery	Lithium Battery 12v 7a/H	TMK-B12V7AHX
12	Screws	Tank Screws	TMK-604X
13	Strap Holder	Strap Holder	TMK-603X
14	Upper Chassis	Upper Chassis	TMK-602X
		Wand Support	TMK-845X



PARTS LIST			
N°	PART	DESCRIPTION	SPARE PART
15	LP Valve	Plastic Wand Valve	TMK-920ELPNX
16	Pressure Gauge	Pressure Gauge 0-100 PSI	TMK-900X
		Plug	
		Protector	
17	Tank Filter	Tank Filter	TMK-201X
18	Outlet Cover	Outlet Connector Cover	TMK-123X
19	Pump Outlet Elbow	Pump Outlet Elbow	TMK-522X
		2 Stainless Steel Clamps	
20	Fuse	Fuse ATO 5A 32V DC	TMK-A3F5AX
21	Outlet Connector	Outlet Connector	TMK-203X
22	Tank Filter	Pump Filter	TMK-121X
	Charger	Lithium Battery Charger	TMK-CRG12V1.5AX

## MAINTENANCE SCHEDULE

N°	ACTIVITY	FREQUENCY
1	Clean tank and suction system with clean water.	With each use.
2	Exterior cleaning	With each use.
3	Recharge battery	After each use or when the charge indicator is red.
4	Valve lubrication	Weekly
5	Clean all filters	With each use.

## TROUBLESHOOTING

PROBLEM	CAUSE	SOLUTION
<b>No discharge</b>	Possible valve obstruction	See "Cleaning Valves" chapter
	Possible nozzle obstruction	Clean the nozzle
<b>No pressure</b>	Possible output connector obstruction	Remove the tank from the lower chassis, uninstall the output connector, clean and remove obstruction. Replace if broken.



PROBLEM	CAUSE	SOLUTION
<b>No pressure</b>	Trapped air in the pump diaphragm	Open the escape valve and release liquids. If problem persists, take sprayer to your nearest authorized service center.
	Wear and tear of pump diaphragm	Visit your nearest authorized service center.
	Sprayer was stored with chemicals The pump diaphragm is plugged.	Visit your nearest authorized service center.
<b>Sprayer does not power on</b>	Wear and tear of pump diaphragm	Visit your nearest authorized service center.
	Battery low on charge	Go to "battery charge" chapter
	The knob is in "min" position	Power on and turn knob clockwise to confirm engine functionality
	Clogged nozzles, causing the system to pressurize	Remove nozzle and clean

PROBLEM	CAUSE	SOLUTION
<b>Battery not charging</b>	Charger is not functioning	Make sure wires are connected on the charger correctly. Make sure the LED is green. In case problem persists, replace charger.
	Damaged battery	Replace battery.
<b>Intermittent function</b>	The knob is in a position that does not work with the nozzle.	Turn knob to reduce pressure
	No more liquid in tank	Power off and refill
<b>Clogged/Open Nozzle</b>	The valve requires maintenance	Lubricate the stem. Replace "O" rings.
<b>Leaks</b>	Leak between the output connector and the tank	Adjust or replace the output connector.
		Replace tank.
	Leaks in tank inserts	Replace tank.
	Leaks between tank and lid	Adjust lid



PROBLEM	CAUSE	SOLUTION
<b>Leaks</b>	Leaks between tank and lid	Replace lid seal
		Replace tank.
	Leak in diaphragm pump	Visit your nearest authorized service center.
	Leak between hose and valve	Adjust clamps. Adjust or replace seals.
	Leak between hose and diaphragm pump	Adjust clamps. If problem persists, visit your nearest authorized service center.
	Leak between valve and wand	Check the seals. If problem persists, visit your nearest authorized service center.
	Leak in valve	Replace "O" rings.
	Leak when valve is closed	Lubricate the stem
<b>Strap holder loosens</b>	Not enough resistance while assembling	See "Adjusting Straps" Chapter.

## TECHNICAL SPECIFICATIONS

<b>General</b>	Tank Capacity	18 Liters
	Pressure	15-60psi
	Gross weight without battery	8.5 lbs
<b>Battery</b>	Specifications	<ol style="list-style-type: none"> <li>Lithium Ion 12V 7 Ah / 2.6 lbs</li> <li>Lithium Ion 12V 4.8 Ah / 1.7 lbs</li> </ol>
	Battery Range	<ol style="list-style-type: none"> <li>&gt;4.0 continuous hours with a 1200cc nozzle @ 45 psi</li> <li>&gt;3.0 continuous hours with a 1200cc nozzle @ 45 psi</li> </ol>
	Charging Time Battery Life	5 hours approximately >1000 charging cycles
<b>Pump</b>	Open Flow	4.0 lpm
	Max Pressure	60 psi
	Typical / Max Consumption	1.5 Amp / 2.6 Amp
<b>Efficiency</b>	Spray Control	0 - 100% engine potency Digital / several options
<b>Charger</b>	Power Supply	110-240V AC 50-60Hz
	Nominal Voltage	12V
	Operation Temperature	-20 a +50°C
	Output	14.4V – 1500 mA



## GOOD USE PRACTICES

- The pump will continue working once liquids have depleted, once this occurs, power off and refill tank if necessary, otherwise proceed to cleaning the sprayer as previously indicated in this manual.
- While in storage, periodically charge battery every 30 days to avoid deterioration.
- Once the battery is fully discharged after use, recharge battery before storing.

## WARRANTY

- Tomahawk Power guarantees that this product is free of manufacturing defects at the time of purchase. If your sprayer presents any flaws during the first 12 months after the date of purchase, Tomahawk Power will repair or replace, depending on each case.
- This warranty does not apply to faults caused by misuse, abuse, accidents, negligence, harmful environment, or expected wear and tear.
- Tomahawk Power is not responsible for any direct or indirect losses attributable to this product.
- Dear Customer, in order to validate the warranty of your sprayer, take sprayer to an authorized service center. You will need to have your product registration card and a copy of the receipt of purchase.
- By using Tomahawk Power spare parts and following the maintenance guidelines provided in this manual, guarantee the following:
  1. Tomahawk Power will respond to damages caused by other components, that occur within the 12-month time frame the warranty covers.
  2. Replace components have a 90-day warranty, or for as long as the warranty lasts.

## Reasons for the loss of the right for warranty coverage:

1. Sprayers that are out of the 12-month warranty period.
2. If the damage is related to:
  - Omission of instructions provided in the operation manual
  - Operating the sprayer with damaged components
  - Not following the maintenance guidelines
  - Use of non-original components
3. Any type of equipment alteration

## Exclusions and Limitations

- Tomahawk Power's warranty obligation does not apply in the following cases:
  - Damages caused by accidents or inadequate equipment use
  - Damages occurred during transportation of the equipment after purchase
  - Not following the maintenance guidelines provided in this manual
  - Normal repairs caused by wear and tear of equipment
  - Wear and tear of accessories, screws, springs, valves, hoses, filters, seals, clamps.
  - Using unauthorized tools
  - Some pieces are subject to normal wear and tear and should be replaced as soon as possible. The following parts are not included in the warranty:
    - Packaging and rubber gaskets
    - Spray nozzles
    - Filters
    - Battery
    - Pump
    - Engine

## HOW TO REQUEST A WARRANTY

- Register your Tomahawk sprayer at [www.tomahawk-power.com/pages/product-registration](http://www.tomahawk-power.com/pages/product-registration)
- Place service requests at [www.tomahawk-power.com/pages/service-request](http://www.tomahawk-power.com/pages/service-request)