

Yaber

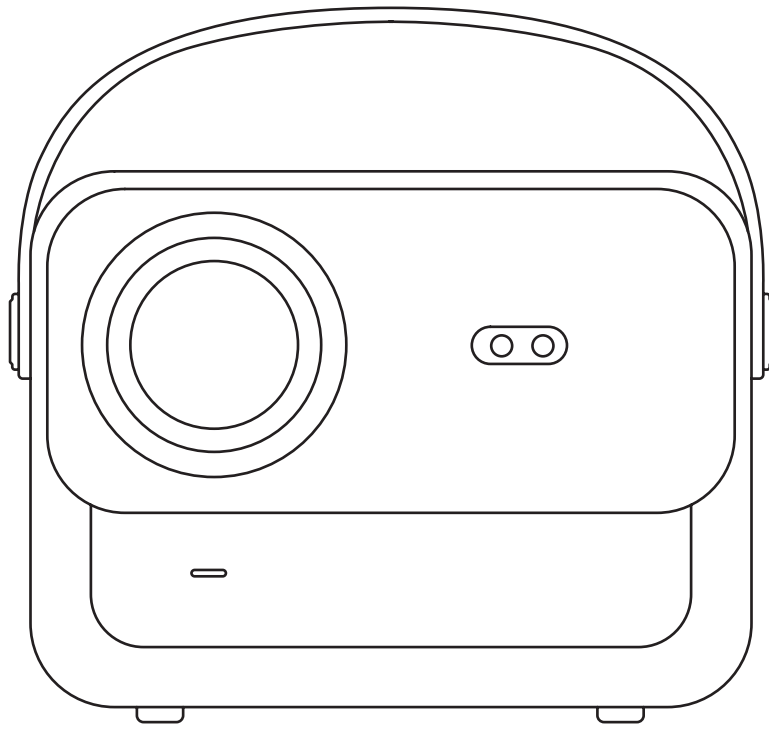

V12 PROJECTOR

LANGUAGE

English	03-36
Deutsch	
Français	
Italia	
日本語	
한국인	
Polish	
Spanish	

CONTENTS

YABER Lifetime Professional Support	04
Precaution	04
Package List	05
Projector Specifications	06
Projector Overview	07
Remote Control Overview	08
Base Installation	09
Install on the Ceiling	10
Distance and Projection Size	10
Adjustable base mount	11
Connect Devices	11
Operation	12
1. Starting Up the Projector	12
2. Image Adjustment	13
3. Play Content from Officially Licensed Apps	16
4. Projection Connection and Input Source	17
5. Screencast	19
6. Bluetooth Setting	27
7. Other Setting	29
8. Signal Lines Connection	33
9. Power On Mode	35
10. Safe Shutdown	35
Maintenance Tips	36

YABER Lifetime Professional Support

Dear valued customer,

Thank you for choosing Yaber V12 projector. This manual will help you navigate through all the features.

We understand that there may be many questions and concerns that arise during the use of the projector. We are also eager to hear your feedback.

However, leaving a review on the product page does not provide the fastest solution. Many common problems, such as inability to autofocus or keystone, Dolby sound issues, WiFi or Bluetooth connection issues, can usually be resolved with appropriate settings adjustments.

If you encounter any issues, feel free to send your **order number** and the problem to us at **service@yaber.com**. (e.g. **US+V12+000-0000000-0000000+Issues**)

Rest assured, our service team will offer the solution to you with 24 hours.

Your satisfaction is our top priority, and we encourage you to thoroughly explore the contents of this manual.

We wish you an outstanding experience with the V12.

Yaber Consumer Service Team

Precaution

1. Suitable Environment (5°C - 35°C)

Ensure the projector is placed in an environment with a suitable temperature, as extreme heat or cold may impact its lifespan. Avoid placing it in damp environments, such as damp basements or near swimming pools.

2. Adequate Ventilation

Please position the projector in a well-ventilated area to prevent overheating during operation, which may cause power cuts or screen flickering issues.

3. Avoid Prolonged Continuous Use

Please refrain from keeping the projector running for extended periods. We recommend limiting each session to no more than 3 hours to prevent component damage due to prolonged exposure to high temperatures.

4. Power

Please ensure the power source is within the required power range. During thunderstorms, please unplug the power cord from the projector.

5. Safely Care

Handle the projector with care to prevent strong impacts, extrusions, or vibrations, as these may result in internal circuit faults. Avoid moving it during such conditions.

6. Lens Maintenance

The lens directly affects picture quality. Excessive dust accumulation can degrade image quality. Use a soft cotton cloth to gently wipe the lens surface. Avoid using hard cloth or abrasives, as they may damage the glass lens.

Package List

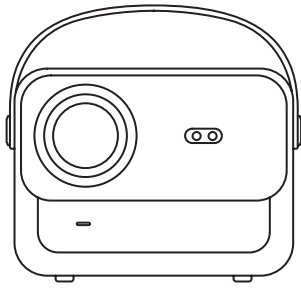

V12 Projector

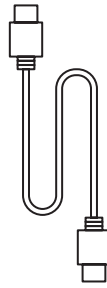

HDMI Cable

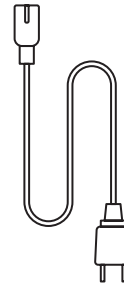

Power Cord

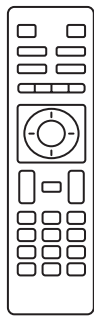

Remote Control

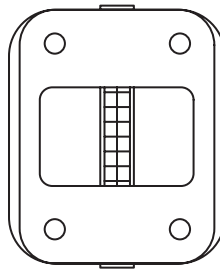

Projector Base

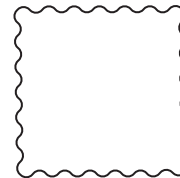

Cleaning Cloth

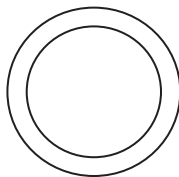

Lens Cover



Quick Start Guide

Projector Specifications

Model No. V12			
Focus	Auto/Eletric	Keystone Correction	Auto/Eletric
Light Source	LED	Display Technology	LCD
Aspect Ratio	16:9/4:3	Interfaces	USB2.0*2/ HDMI1.4*2/ 3.5mm Audio Out*1, Lan*1
Projection Ratio	1.36:1	Recommended Projection Distance	1.3~5.0m (4.5~16.4 Ft.)
Native Resolution	1920*1080P	Unit Dimension	9.8*8.8*7.6 inches (25*22.5.*19.3CM) 7.27lbs (3.3KG)
Power Voltage	100-240V/50-60Hz 2A	Power Consumption	140W
Projector Weight	7.27 lbs/3.3 kg (With Base)	Projection Method	Front/Rear on Desk, Front/Rear on Ceiling
Picture Format	JPEG, GIF, BMP, PNG, JPG		
Audio Format	MP3,WAV,MKA,OGG,FLAC,Dolby Audio		
Video Format	AVI,TS,MPEG,MP4,MOV,M2TS,MKV,FLV,VOB,DAT,M4V,ASF,F4V,3G P,3G2,TP,TRP,RMVB		

Projector Overview

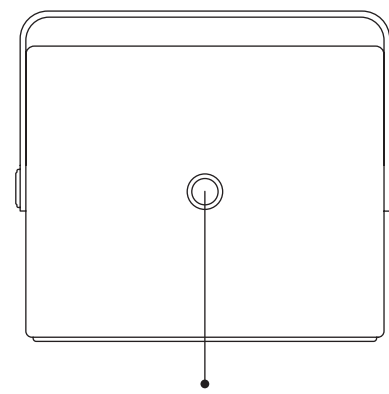
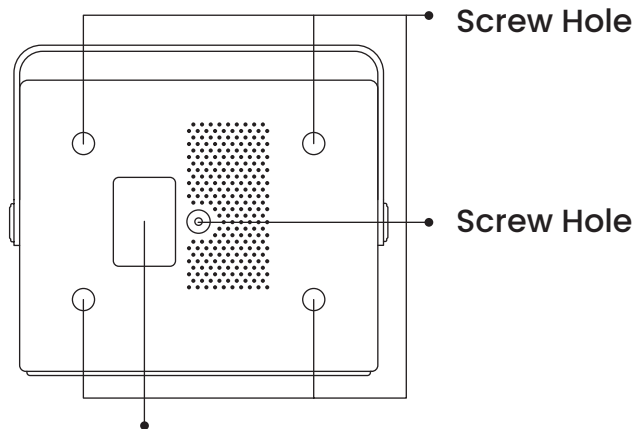
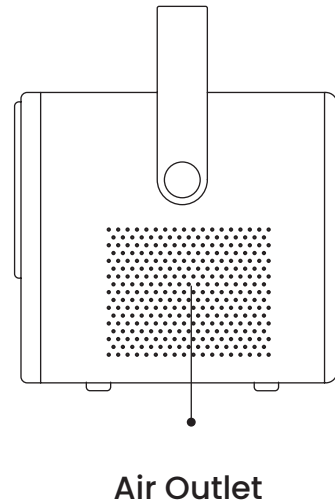
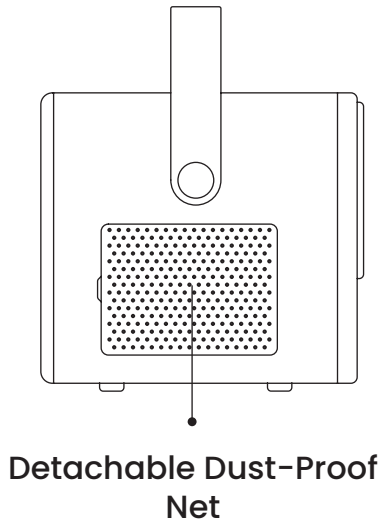
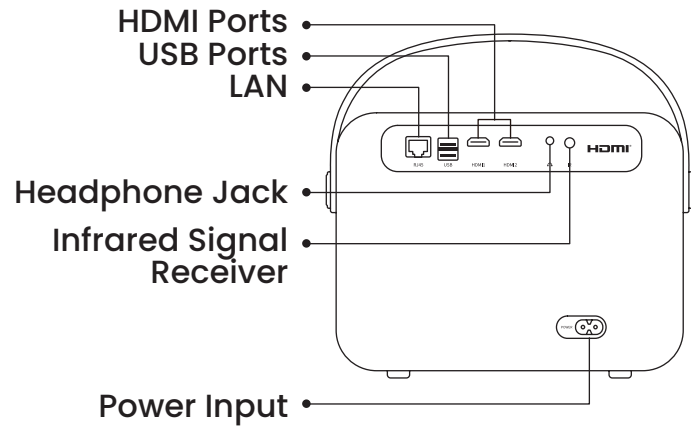
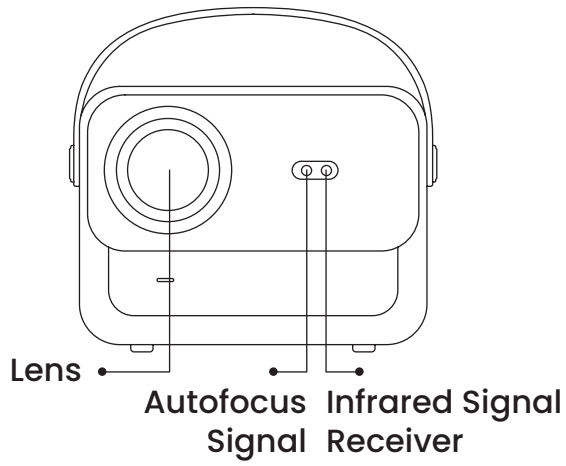

Remote Control Overview

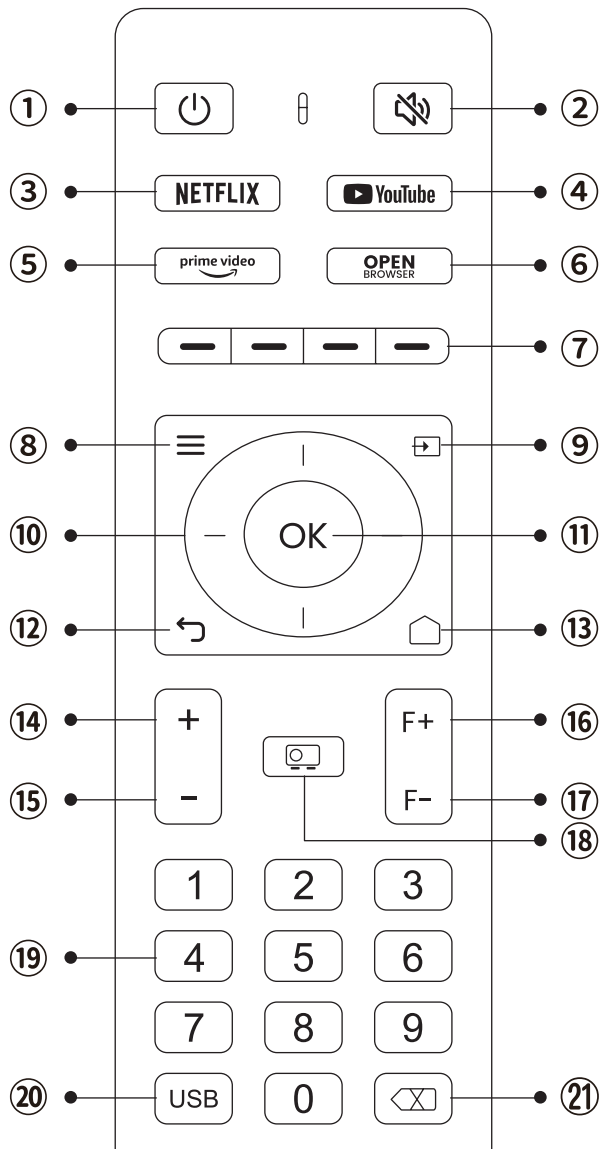

1. Power
2. Mute
3. NETFLIX
4. YouTube
5. Prime Video
6. Open BROWSER
7. Red/Green/Yellow/Blue keys
8. Menu
9. Input Source
10. Arrow keys
11. Confirmation key
12. Back
13. Homepage
14. Volume+
15. Volume-
16. Focus+
17. Focus-
18. Projection mode
19. Number
20. USB
21. Backspace

• Prepare the remote control

1. Open the battery compartment.
2. Insert two AAA batteries with correct polarity indicated.
3. Close the battery compartment.

Note: You must use the Yaber remote control to complete the first time setup of the projector.

Base Installation

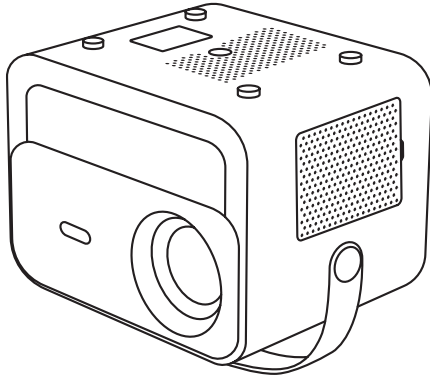

1. Turn the machine over, back side up.

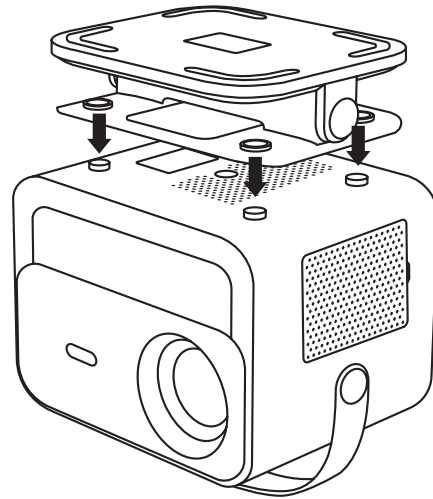

2. Match the holes of the base to the screw holes on the projector.

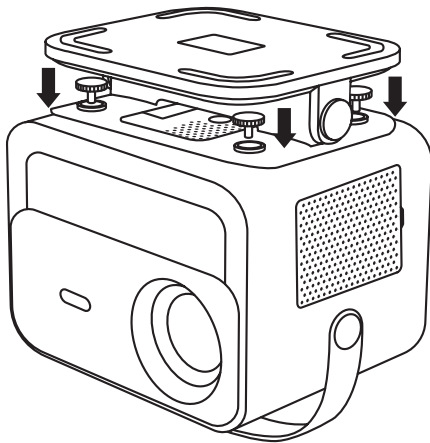

3. Tighten the screws in the accessory box.

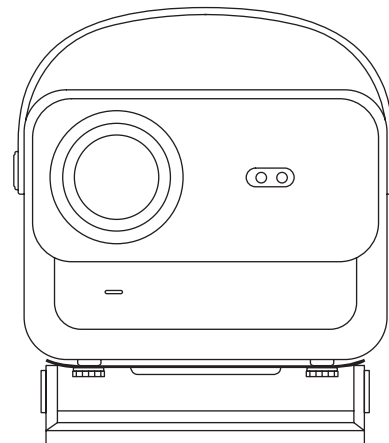

4. Complete the installation.

Install on the Ceiling

1. Prepare a universal projector ceiling mount. **(Not included in the package)**
2. Use **M5*15mm** screws to securely install the projector on the ceiling using the hanger frame.

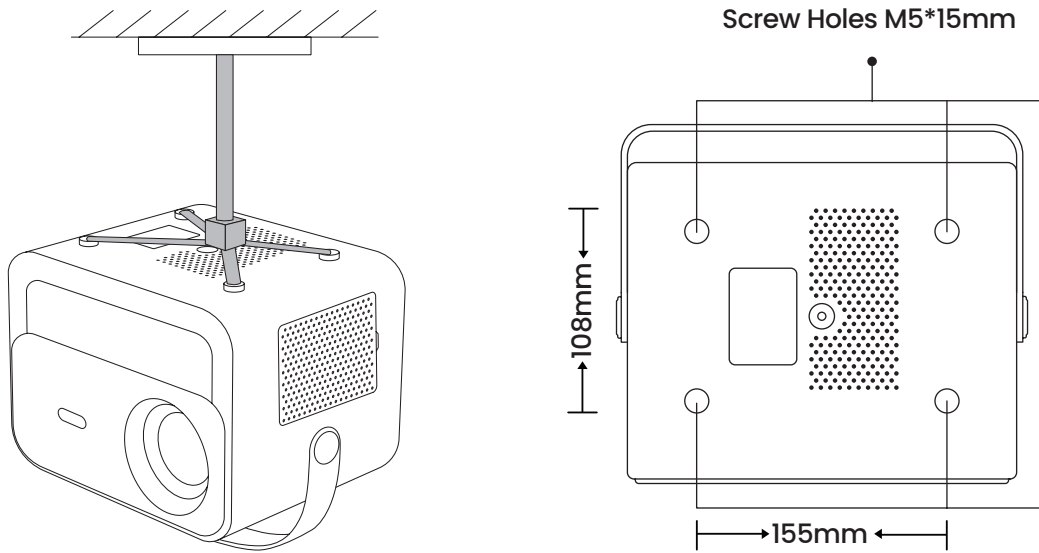

Distance and Projection Size

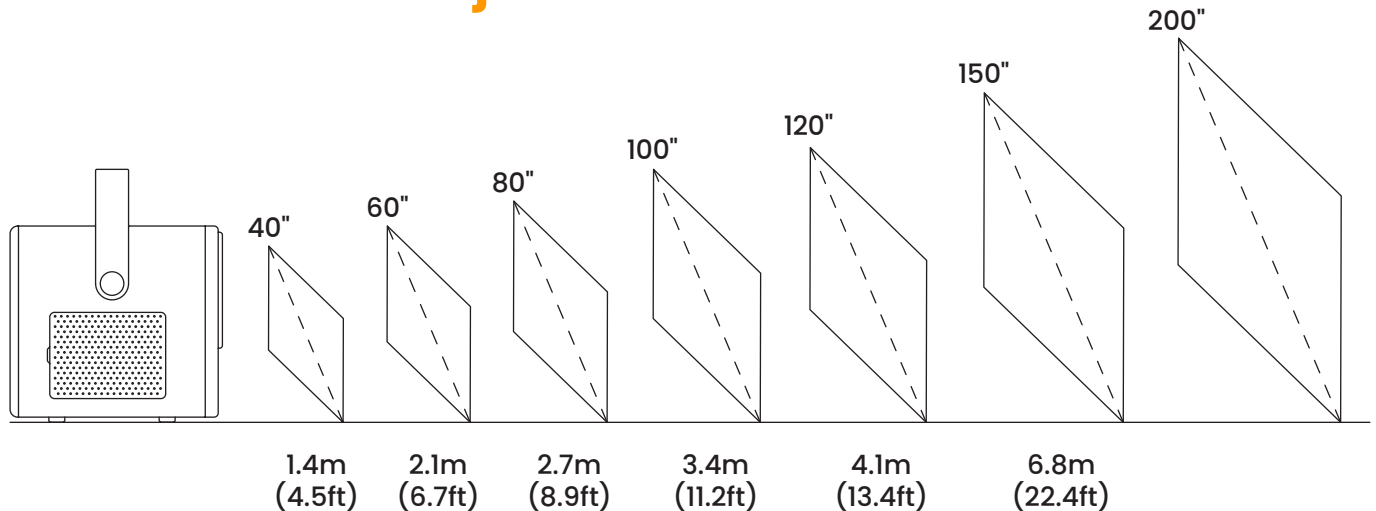

The **recommended projection distance** is about **8.9 ft**, and the **shortest projection distance** is 4.5 ft.

The image size depends on the **distance between projector and screen**.

There may be **3%** deviation among above listed data. Different settings cause various distances.

Adjustable base mount

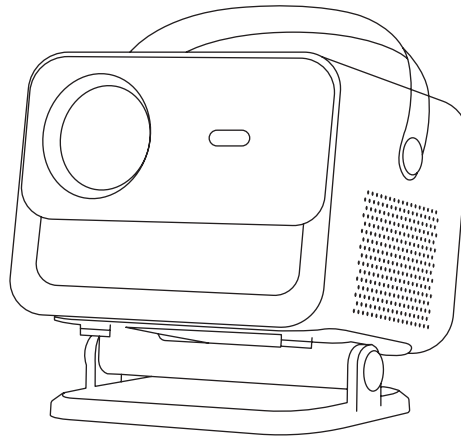

Max Degree: $\pm 30^\circ$
Recommend Degree: $\pm 15^\circ$

You can adjust the projection angle by rotating the Stand.

The maximum adjustment angle for the stand is $\pm 30^\circ$, but for optimal auto-focus and auto-keystone effects, we recommend using angles within $\pm 15^\circ$.

Connect Devices

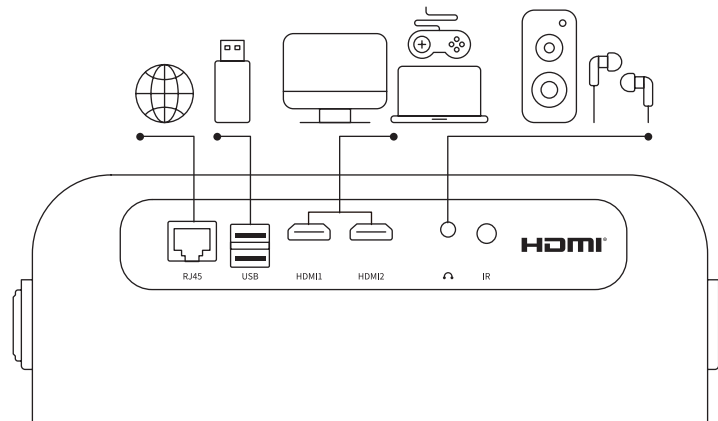

The projector has 6 ports, LAN/HDMI port*2/USB port/USB-C port/Audio out. Please select the correct connecting ports to connect your devices.

Operation

1. Starting Up the Projector

• Power on

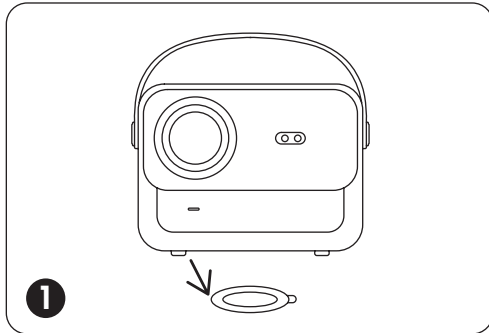

Take off the protective cover.

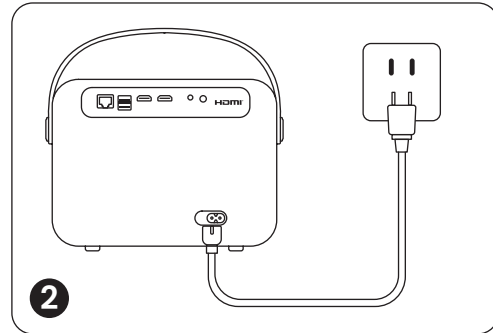

Connect the power cable to an outlet.

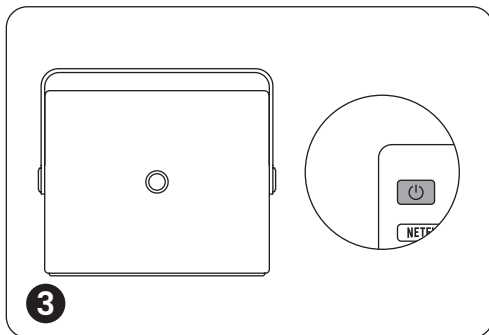

Press the **power button** once to turn on the projector.

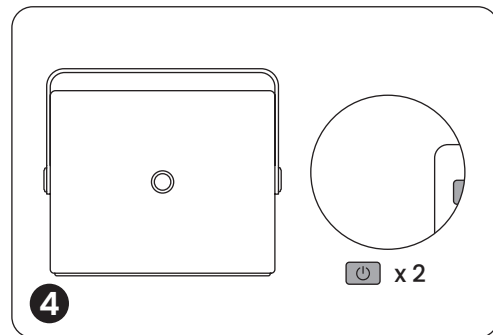

Press the **power button** twice to turn off the projector.

Notice: When you connect the power cord to projector, the orange light will flash 10 seconds. Please wait patiently until the power light stop blinking.

Orange power Light on --- Standby Mode
Orange power Light off--- Working Mode

• First time setup

When you turn on the projector for the first time or the projector is reset to the Factory Default Settings, you are prompted to make the first time setup.

After setup, the projector will go to the Homepage.

2. Image Adjustment

• Auto Focus

When the projector is turned on, please wait for a few seconds, it will automatically adjust the focus. (If not, ensure the auto focus function is activated in Settings -> Focus -> Auto Focus -> On)

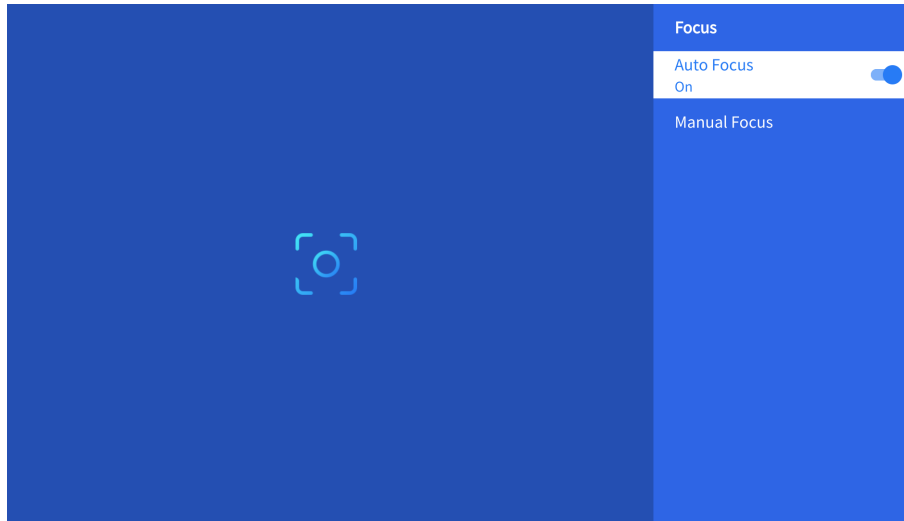

• Electric Focus

You can also adjust the clarity of the screen by clicking or holding down the F+ and F- buttons on the remote control.

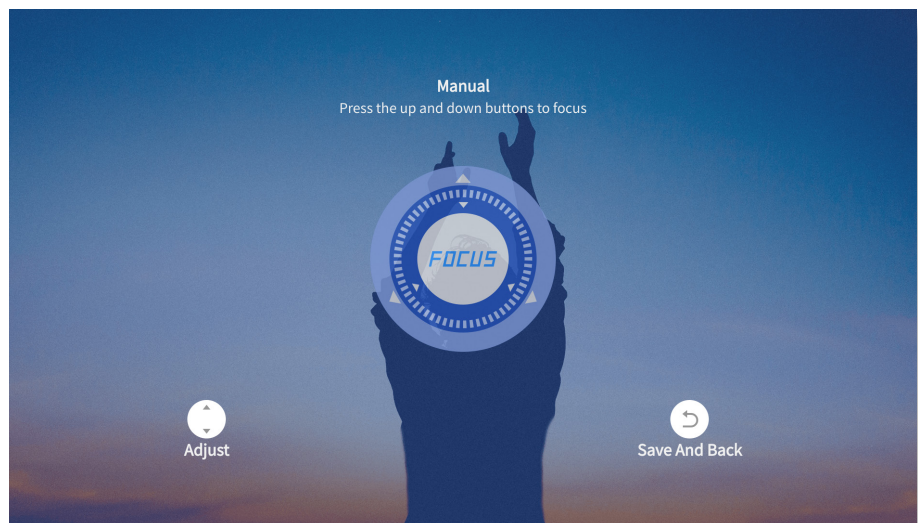
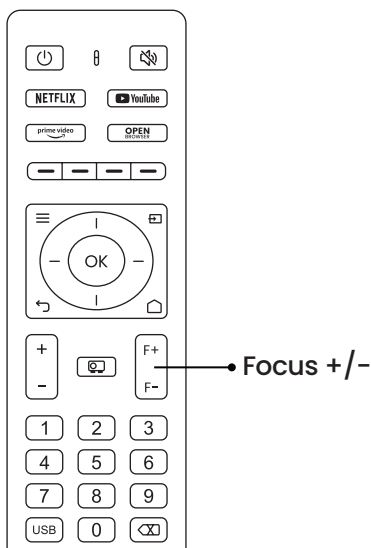

• Auto Keystone Correction

Please place the projector horizontally face to the wall first.

After turn it on, it will automatically adjust the screen to a regular shape.

(If not, ensure the auto keystone function is activated in Settings -> Keystone -> Auto Keystone -> On)

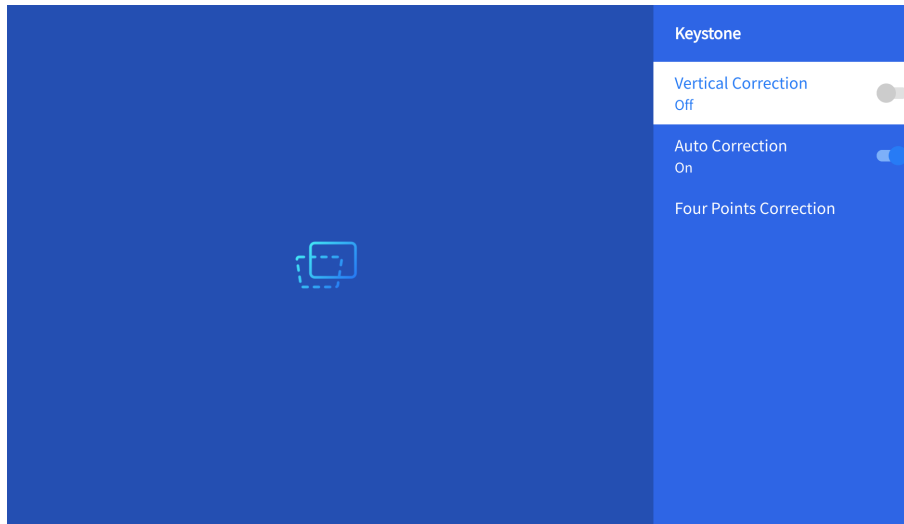

• Manual Keystone Correction

Go to Setting-> Keystone -> Four Points Correction

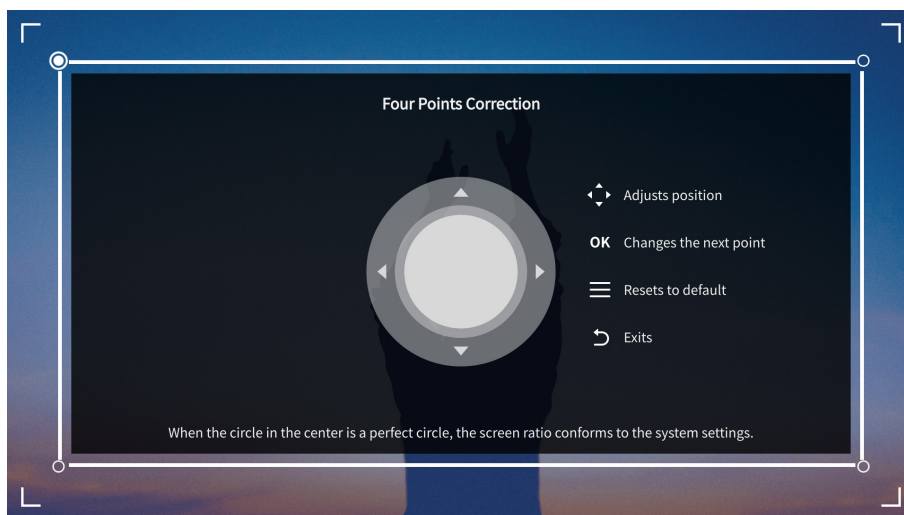

Tips: When the projector detects shaking or rapid movement, it will automatically initiate autofocus adjustment and keystone correction to ensure optimal image quality. If you encounter unclear images or an imperfectly squared display, please use the remote control's focus button for manual adjustment or utilize the four-point keystone correction to manually correct the image shape.

• Projection Mode

Go to Setting-> Projection to select the appropriate projection mode based on the placement of the projector.

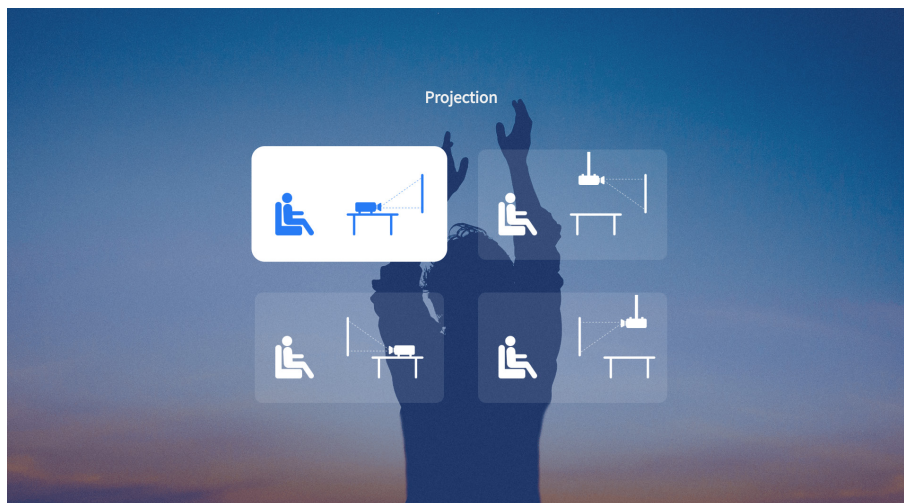

• Zoom

Go to Setting-> Zoom to reduce or enlarge the image size between 50% to 100%.

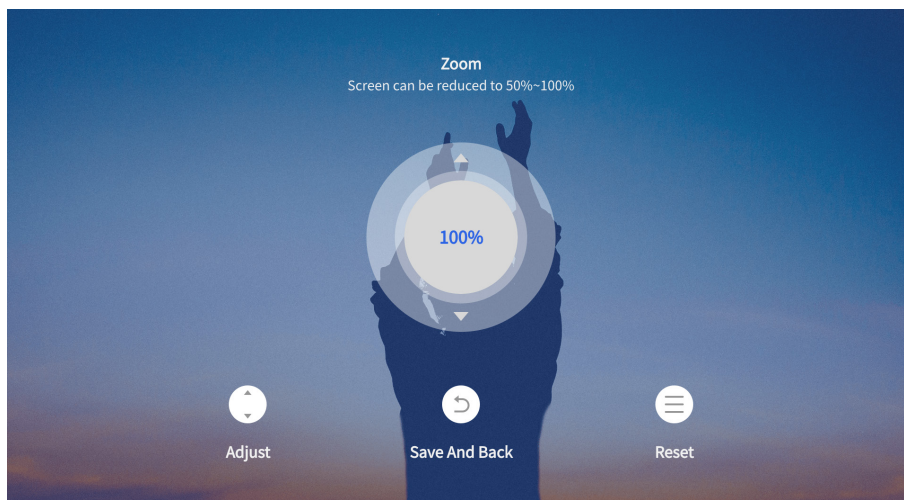

3. Play Content from Officially Licensed Apps like Netflix, Youtube and Prime Video

Go to the homepage, select your preferred channel, or access it through the shortcuts on the remote. Log in to your account to play the corresponding content.

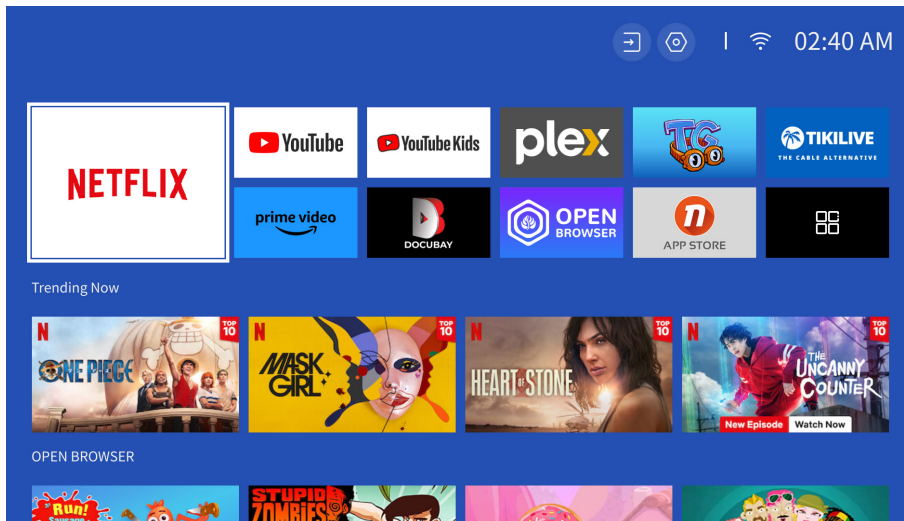
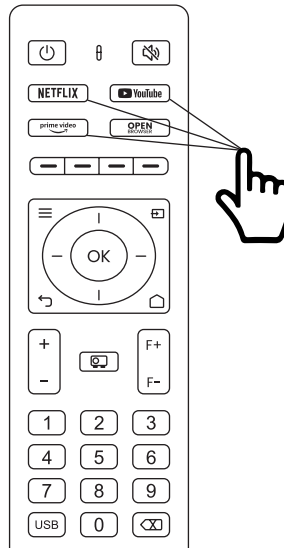

4. Projection Connection and Input Source

Please follow the page 11 instructions to properly connect your devices to the projector, then select the correct input source.

• USB Disk Input Mode

1. Insert the USB Disk

2. Click on the input source [] on the remote control or choose the input source icon on the homepage.

3. Select "USB" as input source

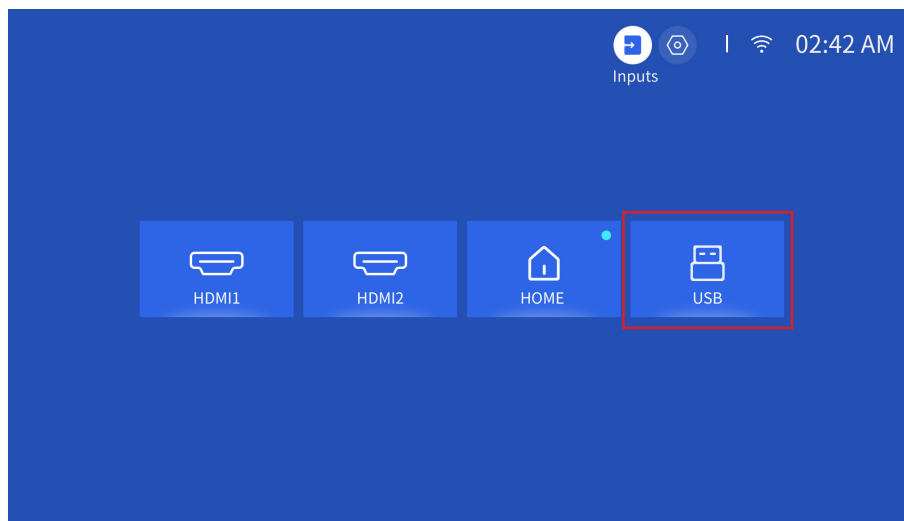
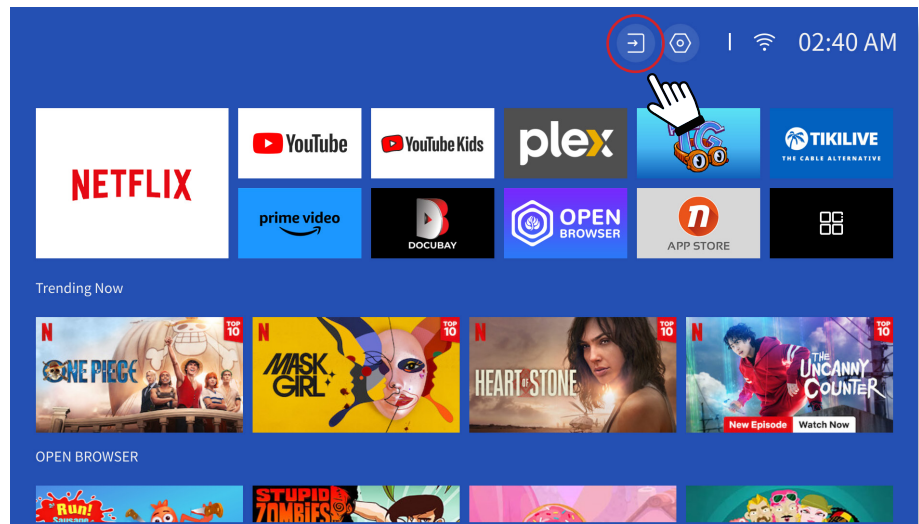
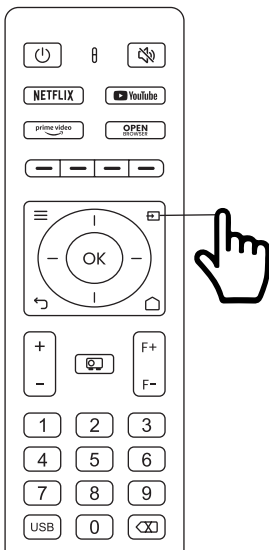

Warning: If the projector cannot recognize the USB disk, please refer to the following methods to solve the problem.

1. Please confirm whether your USB disk meets the following formats: (1) FAT32: 8G/16G/32G; (2)NTFS: 64G
2. If the USB disk is not recognized/detected, please format it. Before you format the USB disk, make sure to backup everything. After formatting, everything will be lost forever.
3. If the problem is still not solved, please send your problem to this email: service@yaber.com

• HDMI Input Mode

Connect your device with an HDMI output to the projector using the provided HDMI cable. Press the input source button on the remote and select HDMI1 or HDMI2.

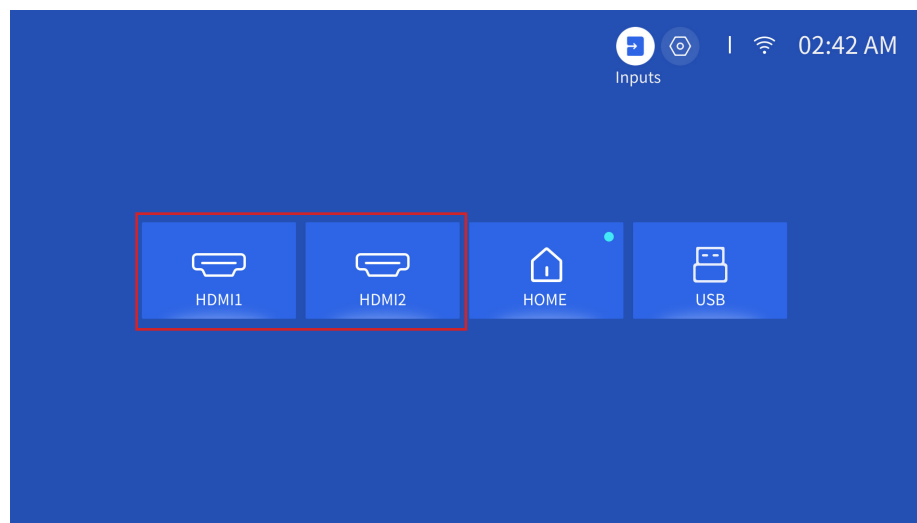
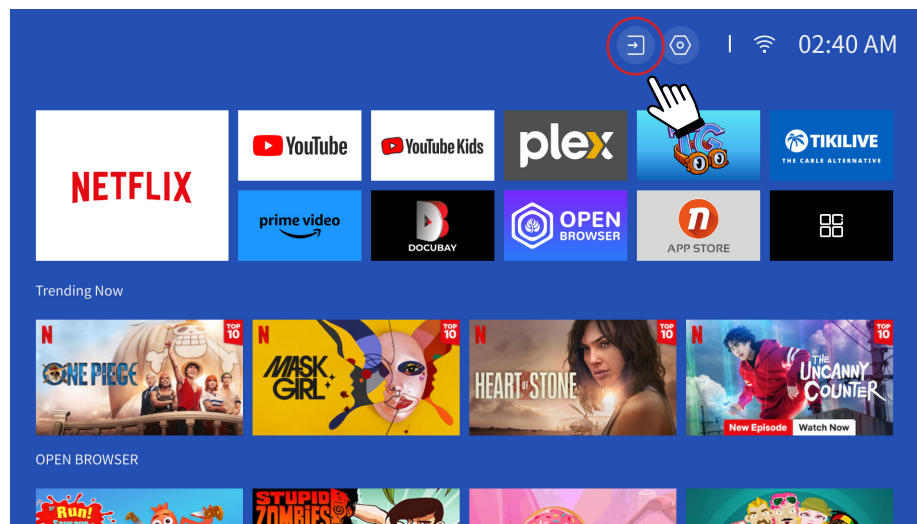
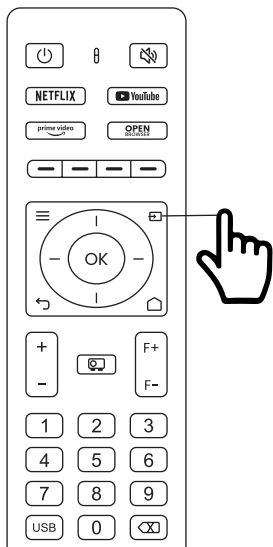

• Wired Speaker and Headphones Connection

This option is not required to select AV input source

5. Screencast

Warming Tips:

1. The fluency of screen mirroring with wireless connection will be affected by the network environment. A bandwidth of 100Mbit or more is recommended when using screen mirroring.
2. Make sure your mobile device is close to the projector when using wireless connection. A distance within 1 meter is recommended.
3. Some mobile devices may not support screen mirroring due to the compatibility.
4. Any questions, please feel free to email YABER via service@yaber.com

iOS Cast (for iOS Devices)

• iOS Wi-Fi Mirroring

Step1:

Connect the projector and your mobile device to the same router's WiFi

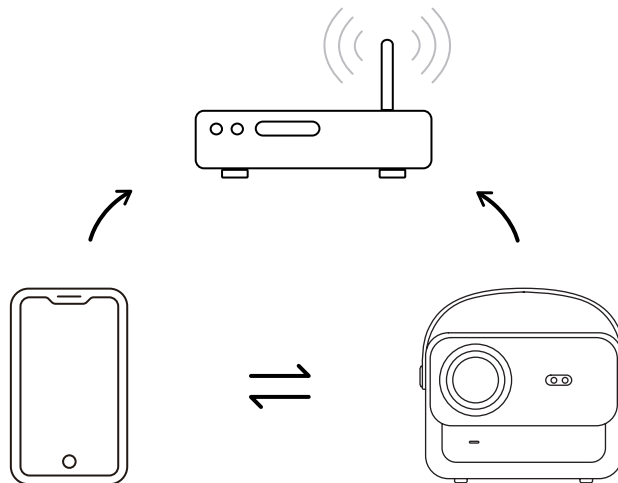

Step2:

Go to [Homepage] -> [My Apps] -> [App Assistant]and then select and download ScreenShare

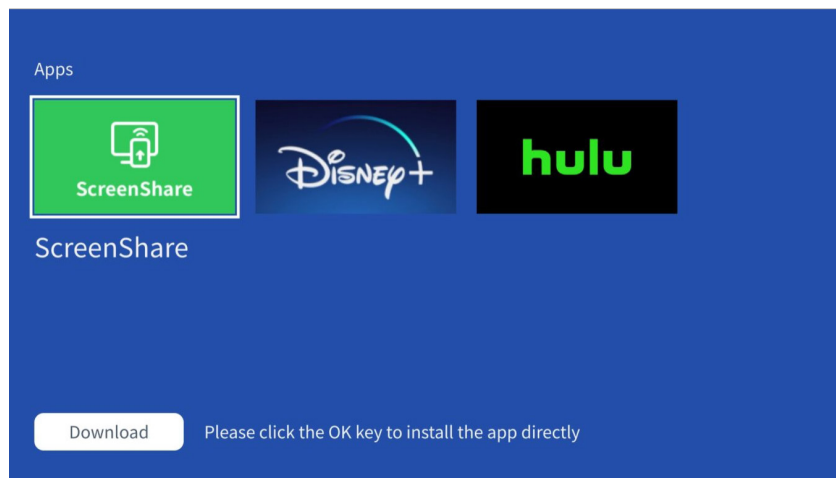
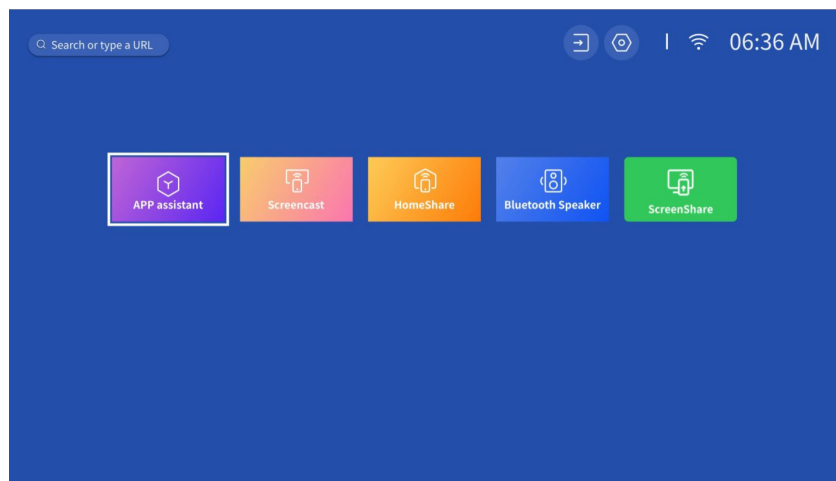
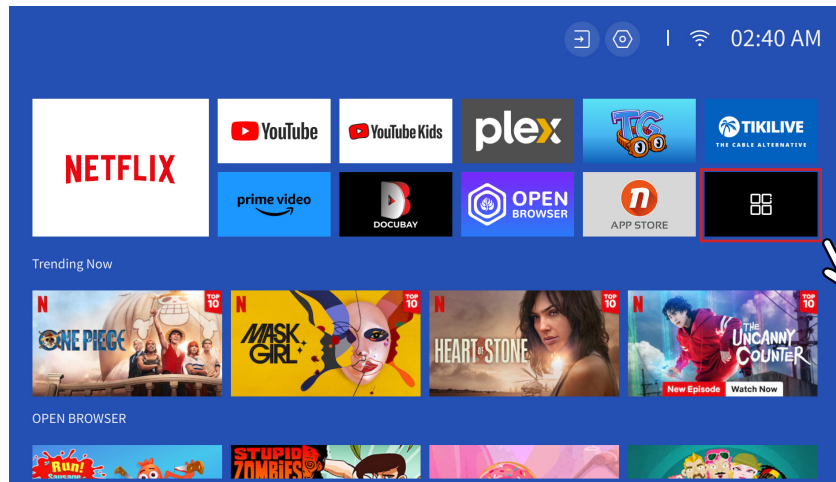

Step3:

Go back to **[My Apps]** page -> Launch the **[ScreenShare]** App and remain on the following page.

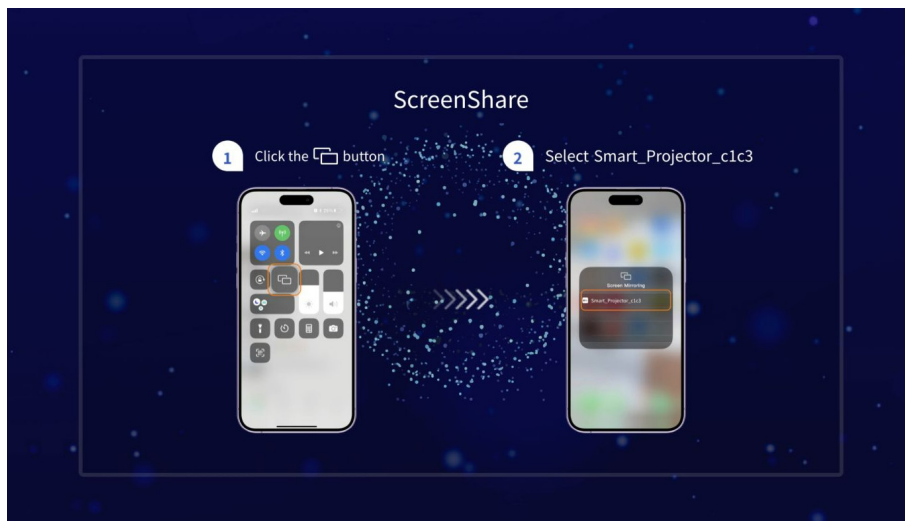
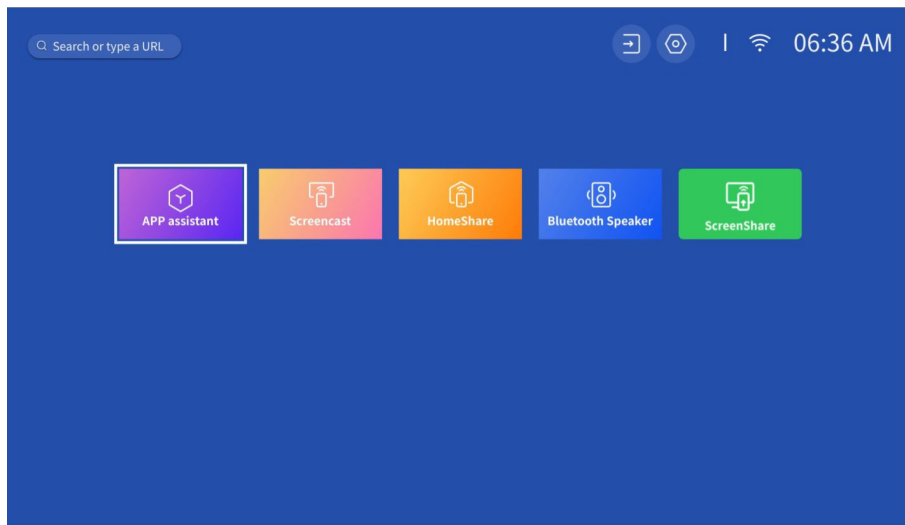

Step4:

Go to the **Control Center** of your iOS device. Then tap **Screen Mirroring/Air Playing** to search for the projector.

Step5:

Choose [**Smart_Projector_XXXX**] from the list, and once the connection is successful, the content on your iOS device will be mirrored onto the projection screen or wall.

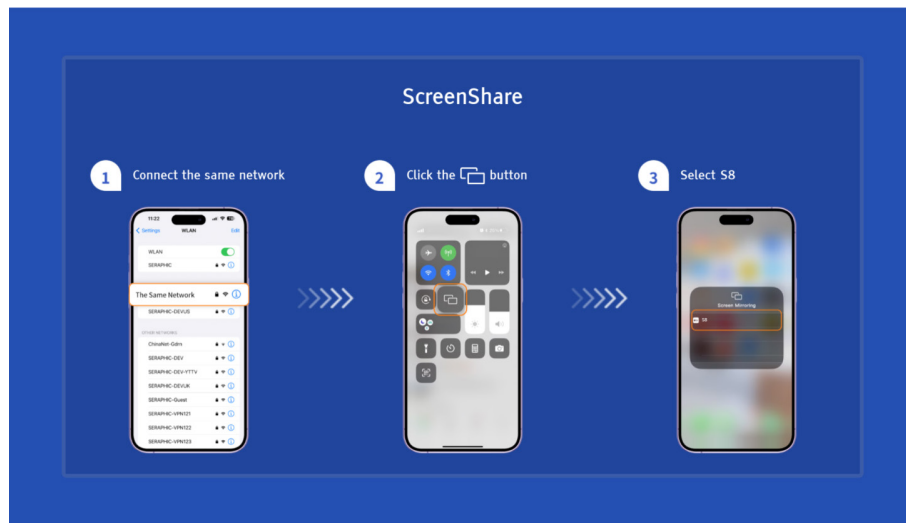

• iOS AP Mirroring

Step1:

Turn on the Wi-Fi on your iPhone/iPad and connect to projector hotspot: [**Smart_Projector_XXXX**]

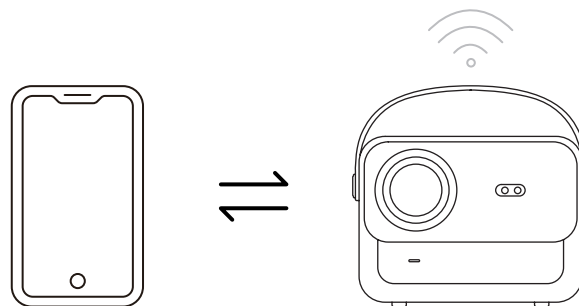

Step2:

Press the  Screen Mirroring of iOS device and then choose [Smart_Projector_XXXX]

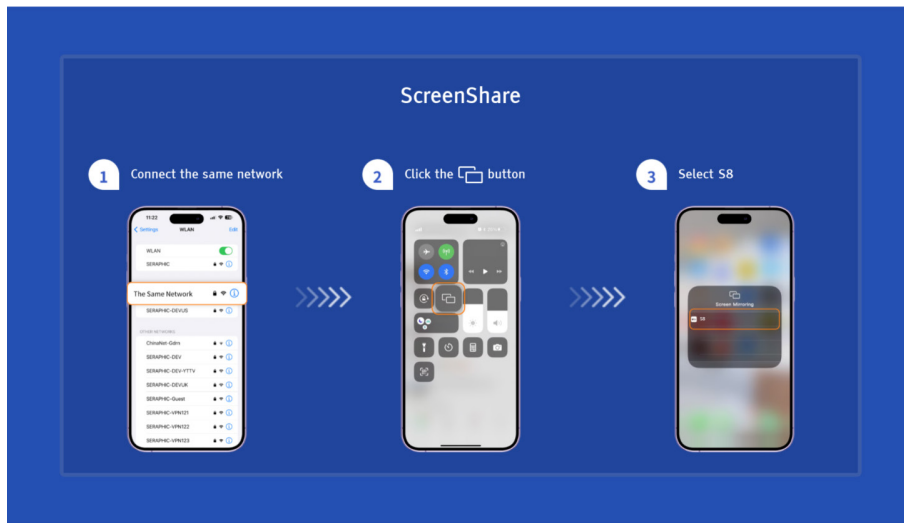

Miracast (For Android Device)

Warning: To activate this function, your android device must support Multi-Screen/Wireless Display. The name of “Multi-Screen” may vary depending on various brands of Android devices.

Step1: Please enable the Wi-Fi function on your Android phone (no need to connect to Wi-Fi).

Step2: Go to Homepage -> My Apps -> ScreenCast

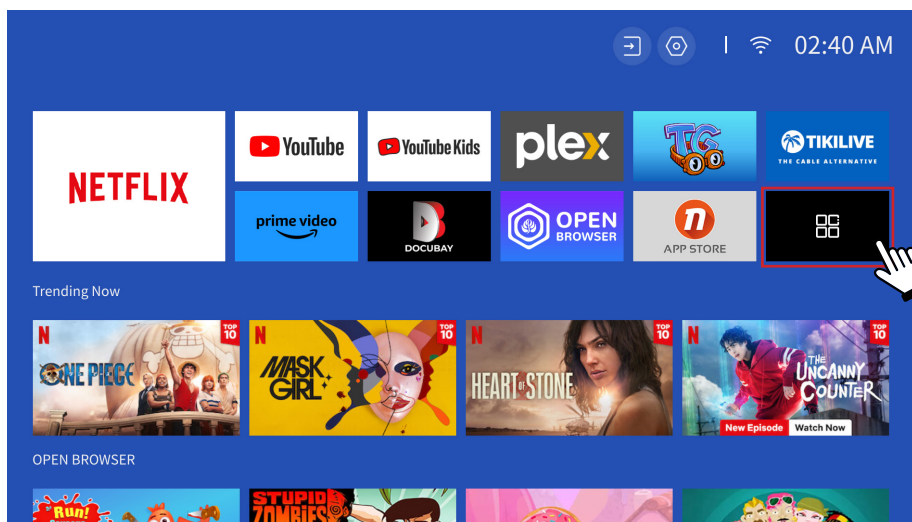

Step3: Activate the 'Multi-Screen/Wireless Display' feature on your Android device

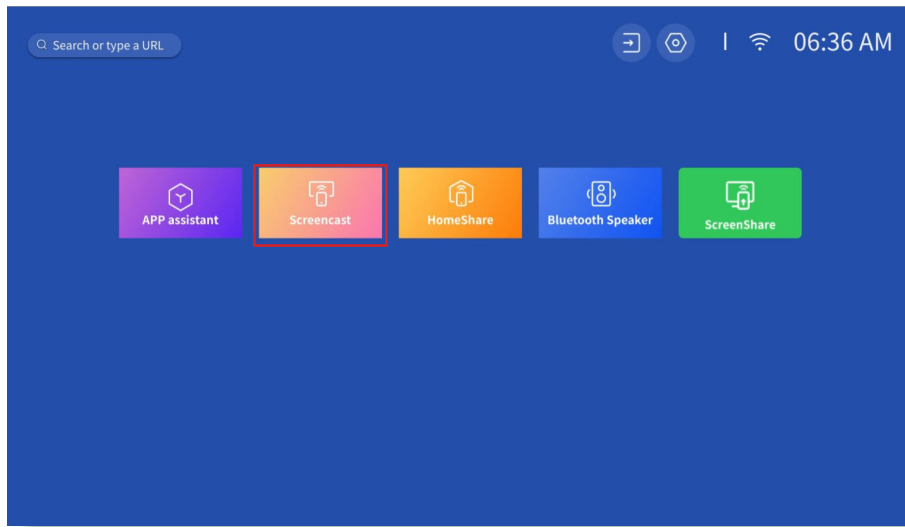

Step4: Choose [Smart_Projector_XXXX] from the list, and once the connection is successful, the content on your iOS device will be mirrored onto the projection screen or wall.

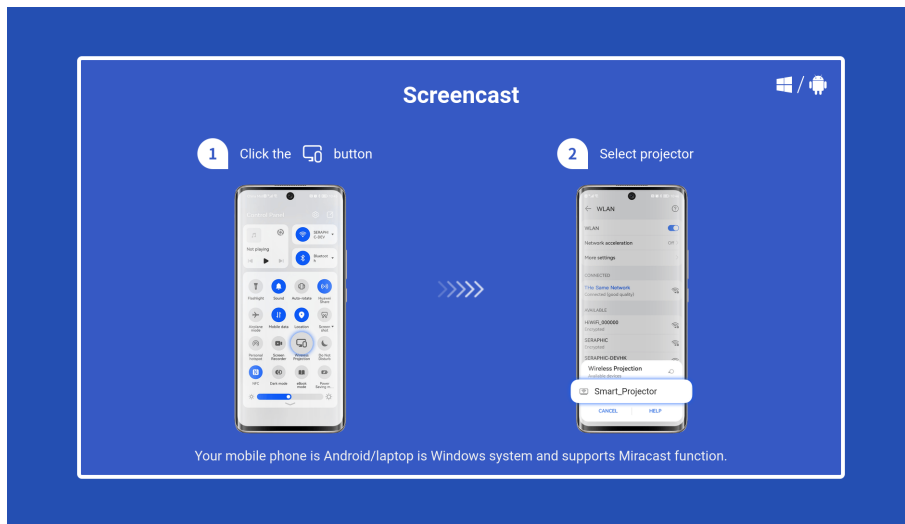

• **DLNA**

Step1:

Connect the projector and your mobile device to the same router's WiFi.

Step2:

Go to Homepage -> My Apps -> HomeShare and remain on the following page.

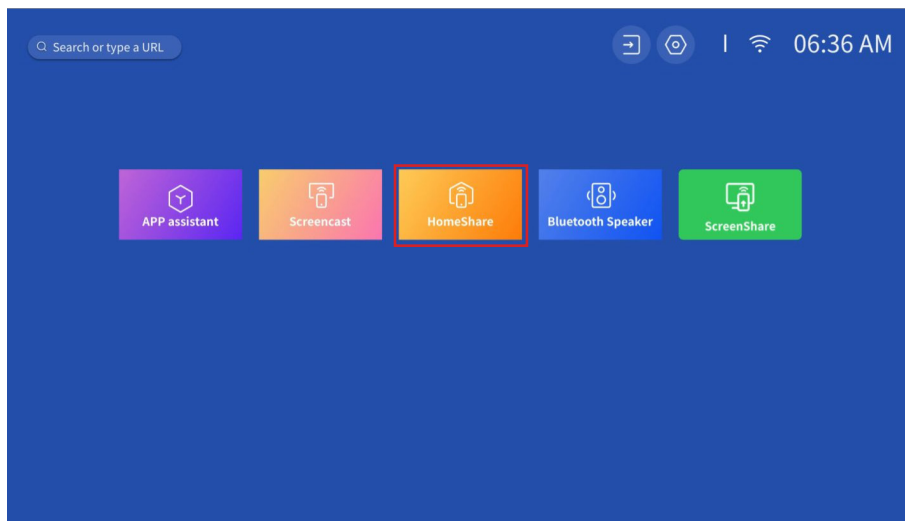
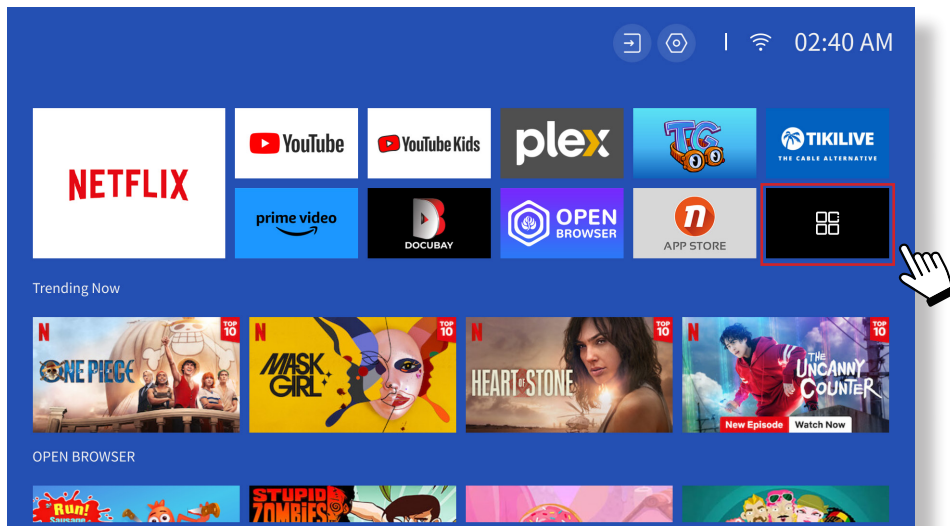

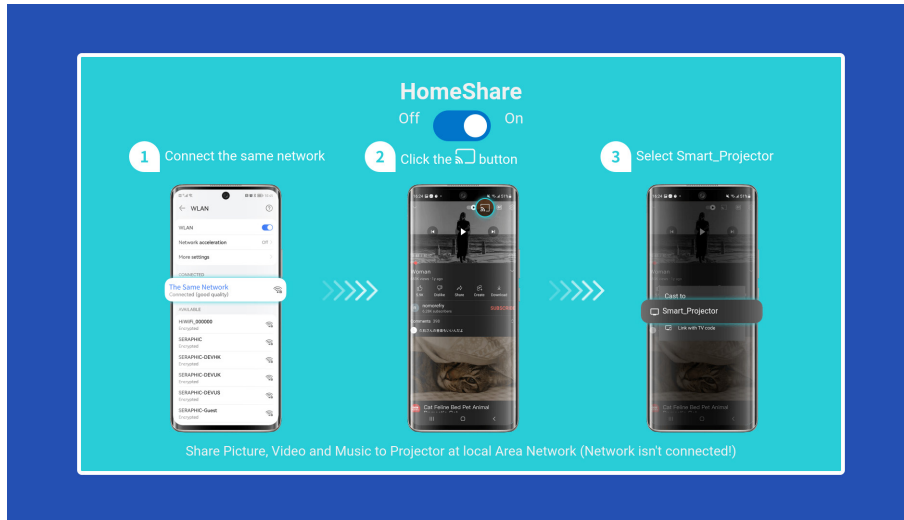

Step3:

Launch a video player App on your mobile device and select a video to play.

Step4:

Tap  to search for the projector and select [Smart_Projector_XXXX] to connect. The contents on your device will be cast to the wall/screen.

Note:

When you cast a video from your mobile device, the video will only be displayed on the projected screen and you can still use your mobile device without interrupting the video or showing any of your other content.

6. Bluetooth Setting

• Connect to an External Bluetooth Speaker

Step1:

Turn on your Bluetooth device and make it ready for a Bluetooth connection.

Step2:

Go to Homepage -> Setting -> Bluetooth to scan available Bluetooth devices, then select your Bluetooth device and pair it with the projector:

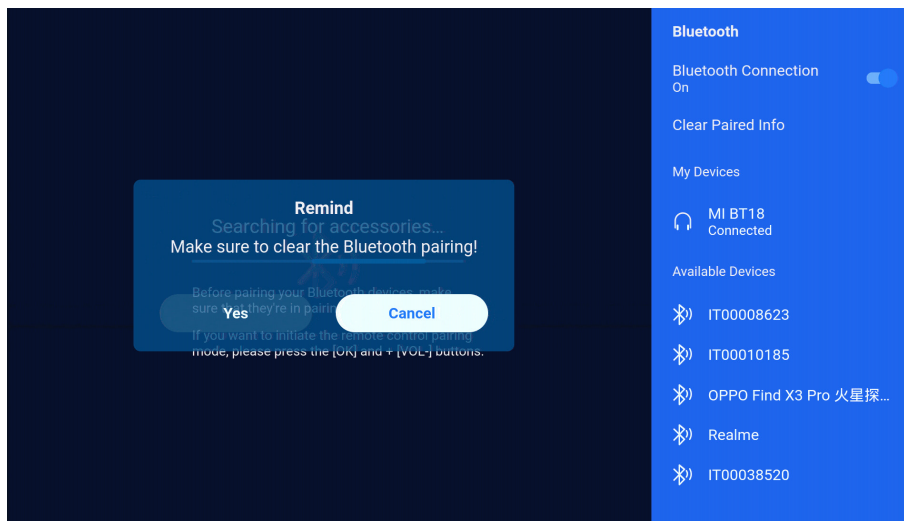

IMPORTANT:

Compared with the wired connection to a speaker, a Bluetooth connection spends more time processing digital audio data, converting said data to an audio signal, and streaming the signal. There may be a delay or slight lag on audio due to signal interference.

As a result, the sound on the speaker may not be in sync with the image on the projector, especially when you are using wireless screen mirroring with WiFi and Bluetooth connection at the same time.

If you are experiencing this situation, please check the following options to improve audio quality:

* Instead of using wireless screen mirroring and Bluetooth connection at the same time, we recommend using an HDMI connection via the provided HDMI cable and Bluetooth connection simultaneously. If you still want to use wireless screen mirroring, it is recommended to output the audio via a wired speaker

* Move your Bluetooth device closer to the projector.

* Keep the projector and your Bluetooth speaker away from other Bluetooth devices to avoid interference.

* You may be able to adjust the latency(Lip Sync)on your device which is playing the video. The way to adjust the latency varies with different devices; please consult with the device manufacturer.

Due to the compatibility issue between Bluetooth speakers/headphones and the projector, few Bluetooth devices may not be paired with the projector via the Bluetooth connection. Please contact us at service@yaber.com for further assistance

• Connect to Device as Bluetooth Speaker

Step1:

Go to Homepage -> My Apps -> Bluetooth Speaker and remain on the following page.

Step2:

Enable the Bluetooth functionality on your device, scan and connect the projector.

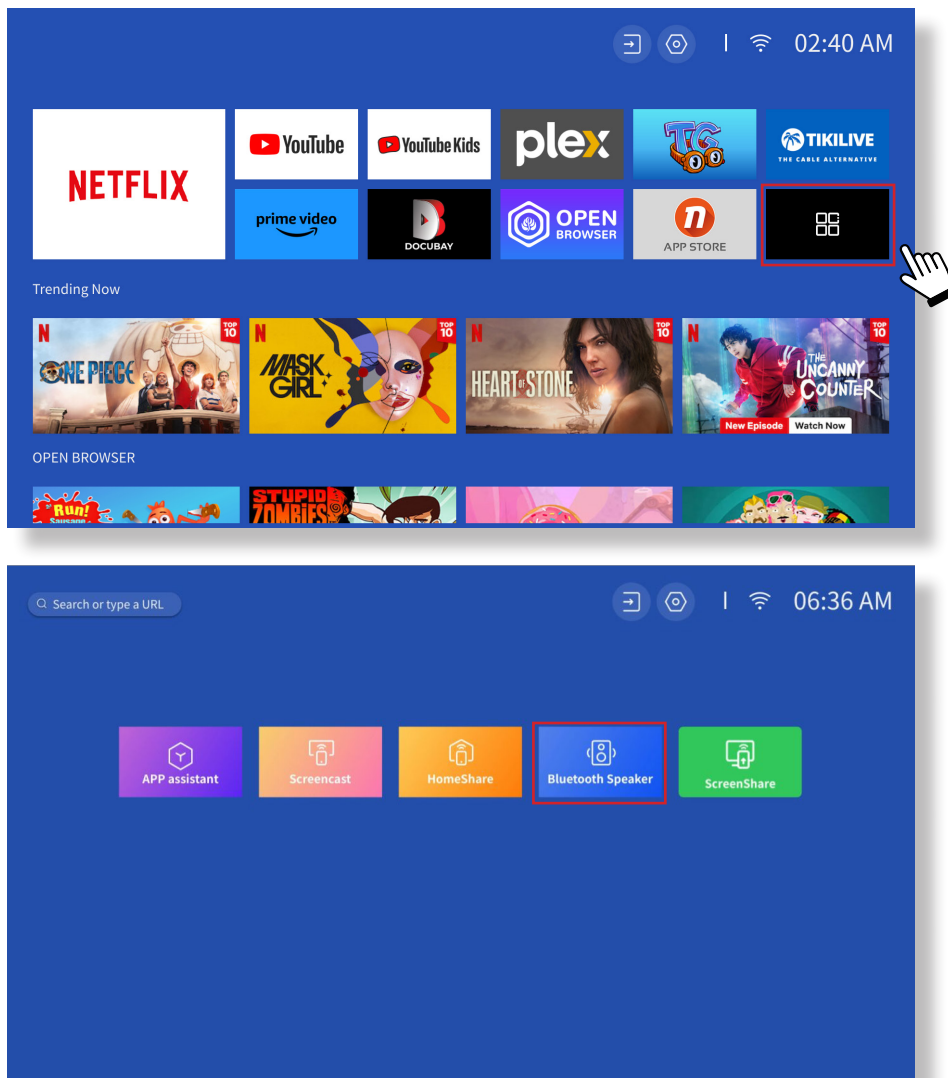

7. Other Setting

• Setup

Go to home page -> Select [**Setting**] -> Select the [**Setup**]. Use the arrow keys on the remote control to switch the menu, press the "OK" to confirm and set.

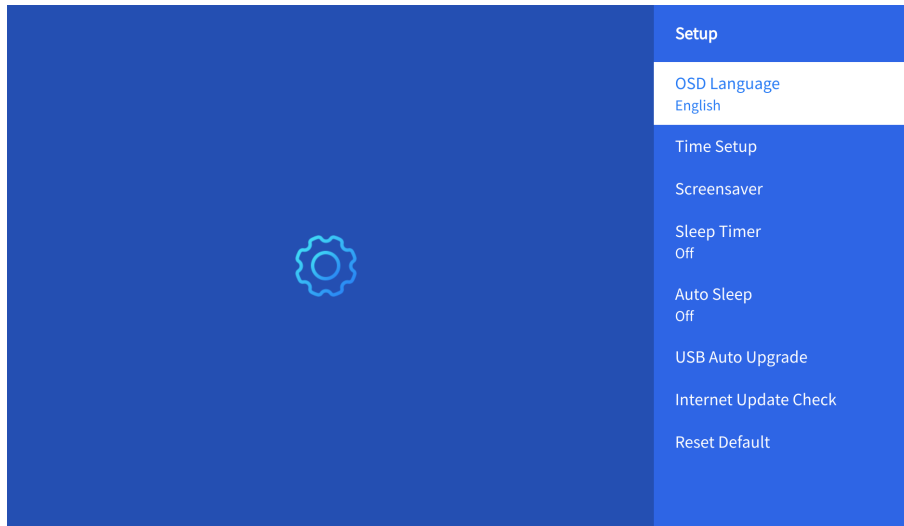

Menu	Content
OSD Language	English/France/Italian/Japanese etc
Time Setup	Set Local Time
Screensaver	Turn on/off screen saver
Sleep Timer	On/Off: Set the sleep time from 10 - 120 minutes
Auto Sleep	On/Off: Set the time from 30minutes - 8Hours
USB Auto Upgrade	Local Update
Internet Update Check	Check Internet Environment
Reset Default	Restore Factory Default

• **Picture Mode Menu**

Go to home page -> Select [Setting] -> Select the [Picture Mode]. Use the arrow keys on the remote control to switch the menu, press the "OK" to confirm and set.

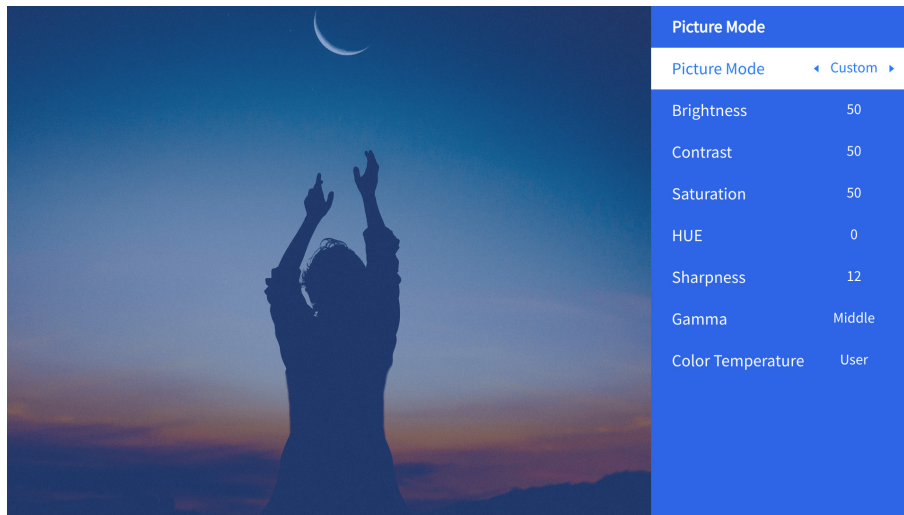

Menu	Content
Picture Mode	Standard/Cinema/Sport/Vivid/Hi-Bright/Custom
Brightness	Set the Screen Brightness Value
Contrast	Set the Screen Contrast Value
Saturation	Set the Screen Saturation Color
Hue	Set the Screen Hue Color
Sharpness	Set the Screen Sharpness Value
Gamma	Bright/Dark/Middle
Color Temperature	Normal/Cool/Warm/Standard

• **Audio Setting**

Go to home page -> Select [**Setting**] -> Select the [**Audio**]. Use the arrow keys on the remote control to switch the menu, press the "OK" to confirm and set.

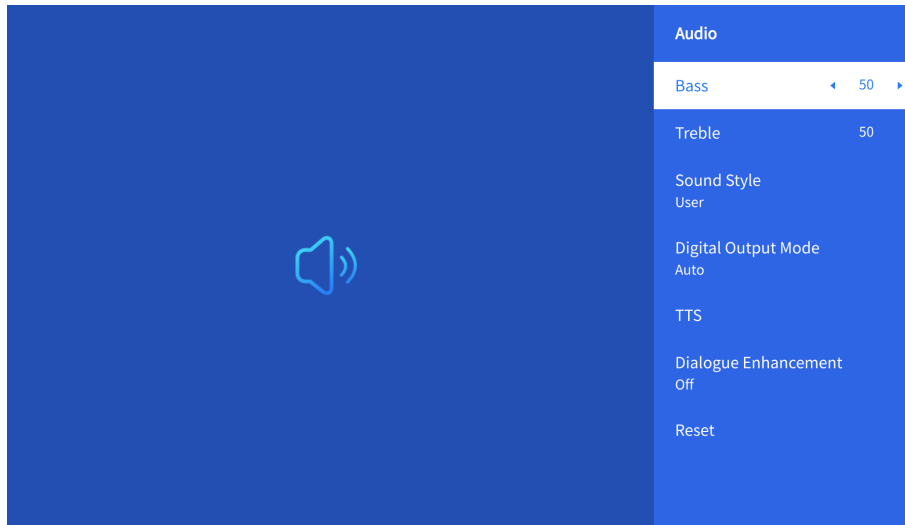

Menu	Content
Bass/Treble	Set Preferred Values
Sound Style	User/Standard/Movie/Music/Sports/Vivid/News
Digital Output Mode	Auto/PCM/Dolby Audio-Dolby Digital/Dolby Audio-Dolby Digital Plus
Dialogue Enhancement	On/Off: Conversation enhancement function, voice, broadcast function for special people Low/Medium/High

• **About**

Go to home page -> Select [**Setting**] -> Select the [**About**]. Use the arrow keys on the remote control to switch the menu, press the "OK" to confirm and set.

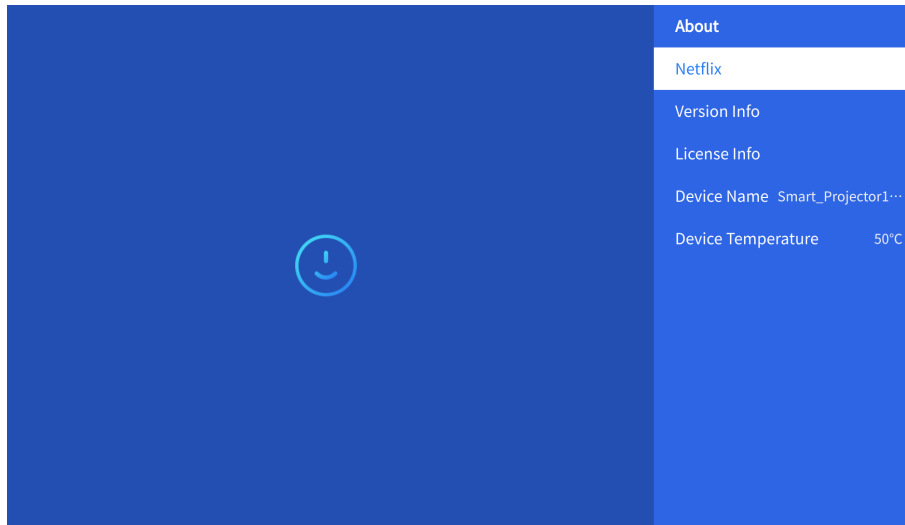

Menu	Content
Netflix	Netflix Officially-Licensed
Version/License Info	View the Latest Version/License Information
Device Name	Projector Model Name
Device Temperature	50°C

8. Signal Lines Connection

① USB Multimedia Connecting

Select the USB signal source, the machine will detect them automatically.

Step1: Select the required category “**photos**” “**music**” or “**video**” in the main interface, and press the “**OK**” key on the remote control to enter the corresponding category.

Step2: Choose the file you want to play, and press the key “**OK**” to play or pause the file. (You cannot enter the required category without connecting a USB disk.)

Note: For the “**Office Suite**” option, PPT/Excel/Word/TXT files cannot be played or presented normally.

② Connecting with PC

Step1: Connect to the computer and V12 projector with the HDMI cable (Included).

Step2: Select the HDMI source to project on the projector;

Step3: On your laptop, hold down the key “**Win+P**”board keys to change your display mode.

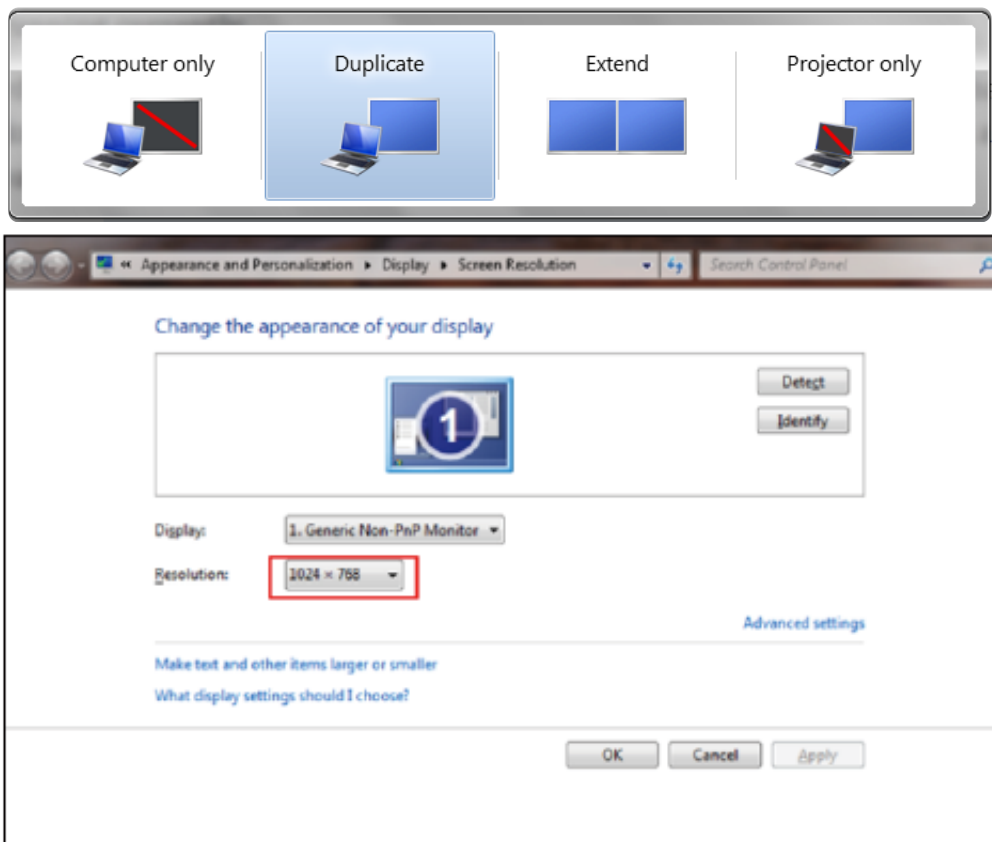

Computer only: it is the default option – only displays on the main monitor.

Duplicate: make all the monitors display the same thing duplicating the desktop on each monitor.

Extend: make all your monitors act like one big monitor extending the desktop across all of them.

Projector only: display only on the secondary monitor like a projector.

To change the screen resolution in Projector Only mode, follow these steps:

Step: **Start** → **Control Panel** → **Appearance and Personalization** → **Adjust Screen Resolution**

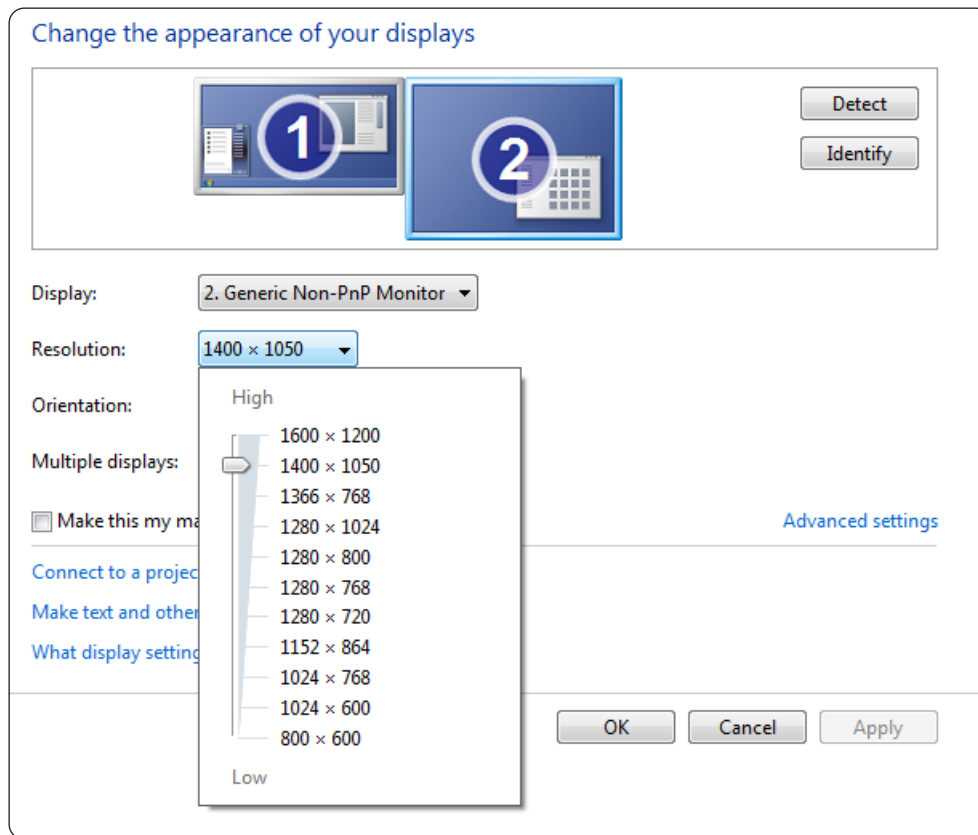

③ Connecting with MacBook or MacBook Air

Step1: Use a **Type-C to HDMI adapter** to connect your MacBook, or a **Mini Display to HDMI adapter** to connect with your MacBook Air. **(Adapter NOT INCLUDED)**

Step2: Choose the media signal channel : "HDMI"

④ Connecting with XBOX/PS5

Step1: Use **HDMI cable** to connect to XBOX/PS5

Step2: Choose the media signal channel : "**HDMI**"

Step3: Succeed

⑤ Connecting with DVD player:

Step1: Use HDMI cable to connect to DVD player

Step2: Select "HDMI" mode for connection

Step3: Enter Menu key

Step4: Change the PC mode from [On] to [Off] to avoid the risk of white pixel edges in the image.

9. Power On Mode

In the Power On Standby mode, plug in the power supply, and the Power LED on the projector will light up. You need to press the power button to turn on the projector.

If switched to Power On, the machine will automatically turn on after plugging in the power cord.

10. Safe Shutdown

1. Press the power button on the projector or remote controller, then press OK key to power off the projector.
2. Unplug the power cord of the projector.
3. Cover the lens and store the projector in a cool and dry place.
4. If you are unable to cover the lens, please adjust the lens forward or backward by pressing the F+ and F- buttons on the remote control before shutting down.

Maintenance Tips

• Care of Projectors

1. Do not place projector in too warm or too cold room, because the high temperature or low temperature will shorten lifespan of the device. The working environment would be 5°C–35°C better.
2. If there are black spots on the projection screen, please don't worry. Please contact service@yaber.com via email, we can send you a video about how to remove the dust.
3. The projector shall be strictly protected from strong impact, extrusion and vibration.
4. Lens, as the core component of the projector, is directly related to the picture definition and effect. Clean the lens whenever you noticed dirt or dust on the surface. Use a canister of compressed air to remove dust from the lens. If there is dirt or smears, use the cleaning cloth to gently wipe the lens surface.



Scan and download the PDF user
manual

Where to Get More Help

✉ service@yaber.com ✉ aftersales@yabertch.com 🌐 www.yaber.com

▶ @Yaber Entertainment Projector 📘 @Yaber