

Buffalo Pro U8

V.22.8.15

CONTENTS

YABER Lifetime Professional Support	02
TIPS	02
PACKAGE LIST	03
PROJECTOR SPECIFICATIONS	03
PROJECTOR OVERVIEW	04
REMOTE CONTROL	06
INSTALLATION	07
1. Installation Method	07
2. Projection Distance and Size	08
3. Install on the Ceiling	08
STARTING PROJECTOR	09
IMAGE ADJUSTMENT	09
1. Focus Adjustment	09
2. Manual Keystone Correction	10
SETTING UP THE PROJECTOR	11
1. Select The Input Signal Source	11
2. USB Disk Insert Mode	11
2.1. Play Video/Music/Picture/Office in the USB Disk Input Mode	11
2.2. Video Play Interface	12
2.3. Music Play Interface	13
2.4. Picture Play Interface	14
3. WiFi Setting	14
3.1 iOS Cast(for iOS Devices)	15
3.2 Miracast(for Android Devices)	16
3.3 Control your projector from the app"MHshare TV"	17
4. Bluetooth Setting	18
5. Projector Settings	19
5.1 Network Setting	19
5.2 Bluetooth Setting	20
5.3 Projection Setting	21
5.4 System Update	24
5.5 General Setting	24
SIGNAL LINES CONNECTION	25
1. Connect USB Disk	25
2. Connect the Devices via the HDMI ports	25
3. Connect to the DVD Player	25
4. Connect to the Soundbar/Speaker	26
SAFE SHUTDOWN	26
WARRANTY	26
TROUBLESHOOTING	27
WARNINGS	28

YABER Lifetime Professional Support

Dear customer,

Thank you very much for supporting YABER!

Please read this manual thoroughly before using the projector. If you have any issues, email your order number and the problem to aftersales@yabertech.com. We will provide a fast solution in 24 hours.

Actually, many problems can be easily solved by setting, such as no signal, no sound, bluetooth connection failed, WiFi connection failed, dark spots, choppy animation etc. We promise all the projectors have been 100% carefully checked and packaged before shipping.

If you have any questions, could you please contact us so that the problem can be solved. And give us an opportunity to improve. We guarantee we will provide you a satisfactory solution.

Thanks for your understanding!
YABER Service Team

TIPS:

1. Do not place projector in too warm or too cold room, because the high temperature or low temperature will shorten lifespan of the device. The working environment would be 5°C~35°C better.
2. If there are black spots on the projection screen, please don't worry, please contact aftersales@yabertech.com via email, we can send you a video about how to remove the dust.
3. The ventilation is equipped for the projector to work stably. Don't cover the vent with cloth, blanket or other things. Don't insert anything into the slit of the projector, or it may produce a short circuit or an electric shock to your device and cause damage.
4. The projector shall be strictly protected from strong impact, extrusion and vibration. Do not try to move and on strong impact, extrusion and vibration. Do not try to move and the internal circuit faults.
5. Lens, as the core component of the projector, is directly related to the picture definition and effect. The excessive dust thereon will affect image quality. The dirty lens shall be wiped with soft cotton cloth for the glass lens surface. Hard cloth or abrasives shall not be used.

PACKAGE LIST

Buffalo Pro U8 Projector*1	Remote Control*1	Power Cord*1
HDMI Cable*1	3-in-1 AV Cable	Lens Cover*1
Quick Start Guide*1	Carry Bag*1	Cleaning Kit*1

PROJECTOR SPECIFICATIONS

Model No. Buffalo Pro U8			
Native Resolution	1920*1080P	Keystone Correction	Quadrangle/ Vertical Trapezoid
Display Technology	LCD	Light Source	LED
Color Temperature	18000-23000K	Aspect Ratio	4:3/16:9
Recommended Projection Distance	3.6-20.3 ft	Minimum Projection Distance	3.6 ft
Power Voltage	AC100-240V	Projector Weight	3.6 lb
Picture File	JPG/JPEG/ BMP/PNG	Interfaces	HDMI*1/USB*2/3.5mm Headphone jack/AV
Projection Method	Front/Rear on Desk, Front/ Rear on Ceiling		
Video File	3GP/AVI/FLV/MP4/MPG/VOB/TS/MKV		
Audio File	MP3/AAC/FLAC/OGG/WAV/MID/M4A		

PROJECTOR OVERVIEW

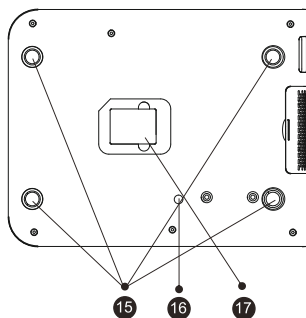
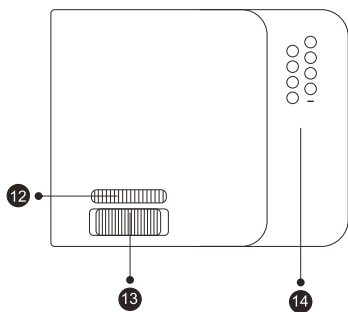
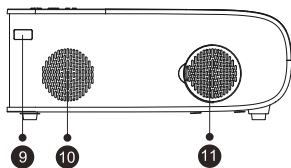
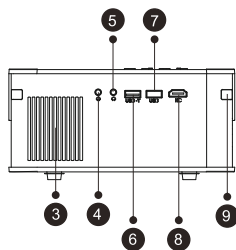
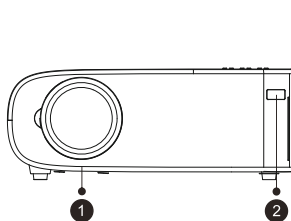

1	Projector lens	Optical coated glass lens
2/9	IR Window	Infrared signal receiver
3	Air Outlet	Prevent the projector from overheating
4	Headphone Jack	3.5mm Headphone Output
5	AV Port	Audio and video input
6/7	USB Port	USB-T Port/USB port
8	HDMI Port	HDMI input
10	Speaker	Stereo 5W
11	Dust Filter Port	Filter dust from the air
12	Manual Keystone Correction	Adjust the shape of the projector
13	Focus Ring	Adjust the focus ring to get the clearest image
14	Panel key	Control projector
15	Rubber Pads	Protective pade/remove to install mount
16	Height Adjusting Screw	Adjust the height of the projector
17	Dust Cleaning Port	Clean the dust(if the screen has a black spot)

REMOTE CONTROL

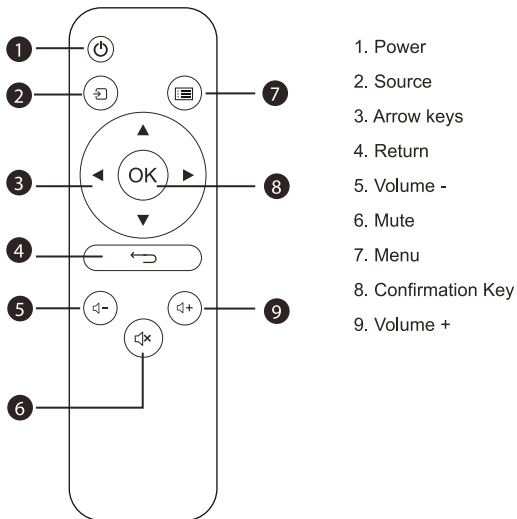

1. Power
2. Source
3. Arrow keys
4. Return
5. Volume -
6. Mute
7. Menu
8. Confirmation Key
9. Volume +

1		Turn on/off the power
2		Select the input signal source
3		Used to adjust the parameter of the projector in the menu mode
4		Return to the previous menu
5		Volume down
6		Close the sound
7		Operate in AV or HDMI Mode
8		Confirm the option
9		Volume up

Note:

- 1).Install 2 pieces of AAA batteries into the remote controller before using it. Do not combine new batteries with old ones in remote controller, which can cause operation failure due to insufficient power supply.
- 2).When using the remote controller, please make sure that the signal transmitter of the remote controller aims at infrared signal receiver of the projector.
- 3).If you are not using the remote controller for an extended period, please take out batteries to prevent batteries leakage.

INSTALLATION

1.Installation Method

The projector can be hanged on the ceiling with special hanger frame, and placed on the stable desk to project the image according to the operating environment and requirements. In addition, the projector can be installed with following methods:

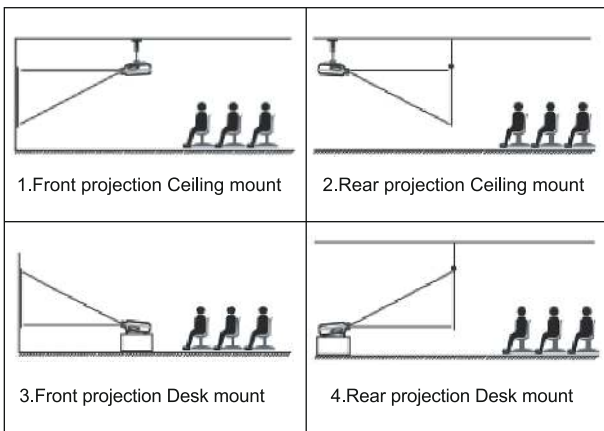

Keep the projector at a height where its lens is axial symmetry to the screen. If this is not possible, use the keystone correction function to adjust the projection image.

If you want to get a free projection screen, please contact us via aftersales@yabertech.com

2. Projector Distance and Size

Aspect Ratio: 16:9	
Distance (ft.)	Screen Size
3.6	35"
5.1	50"
6.6	70"
9.8	100"
11.8	120"
14.4	150"
20.3	200"

The recommended projection distance is about 8ft, the shortest projection distance is 3.6ft.

The image size depends on the distance between projector and screen, there may be 3% deviation among above listed data. Different settings cause various distances.

3. Install on the Ceiling

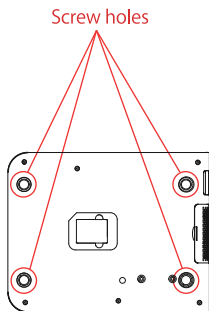
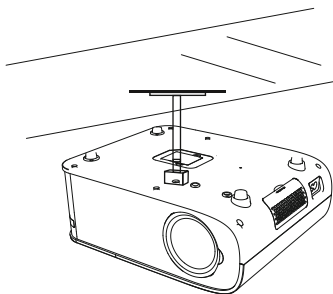

A. Please purchase an universal projector ceiling mount.

B. Remove the four rubber pads on the bottom of the projector, you will see the screw holes and use the M4 screws for installing the ceiling, and then install it.

STARTING PROJECTOR

- 1) Press the power button on the remote controller until the red light goes off.
- 2) Adjust the focus ring of the projector to get the best image performance. (If it is still blurry, please try to adjust the projection distance.)
- 3) Use the vertical/horizontal Trapezoid of the projector to get a rectangle projection screen.
- 4) Connect the external device (Smart phone, iPad, Fire TV, TV box, DVD player, Computer, etc.) in the corresponding interfaces of the projector, please be sure to select the corresponding source. If you do not select the correct source, the projector will not be able to detect the signal.
- 5) Select the [Setting] icon, enter the [General setting] menu, and then you can select the option [Language setting] to set the preferred language of your main system.

IMAGE ADJUSTMENT

When using the projector for the first time, it normally displays an unclear image. This is due to the lens being out of focus or the incorrect trapezoid setting.

Please follow the below steps to correct:

1. Focus Adjustment

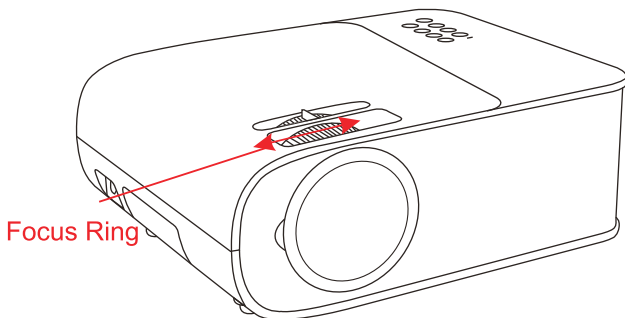

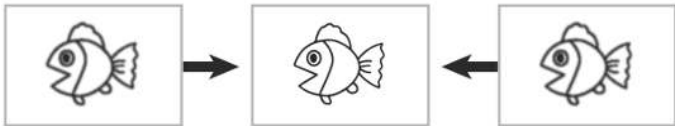

Rotate the focus ring slowly. At the same time, check the focus point carefully. The best focus point for the lens would be where the image most clear. Note: If it is still blurry, please try to adjust the projection distance.

2. Manual Keystone Correction

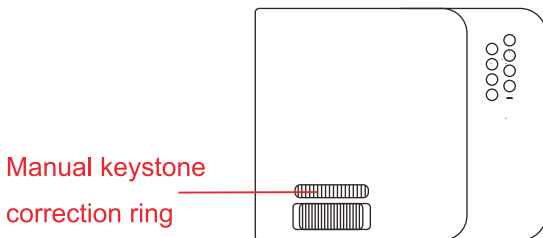

Please follow the below steps to correct:
Adjust the image size to get the best image size by moving the projector back and forth, then rotate the focus ring to get the best focus. Use the manual keystone correction of the projector to get a rectangle projection screen.

SETTING UP THE PROJECTOR

The projector's home page is as follow.

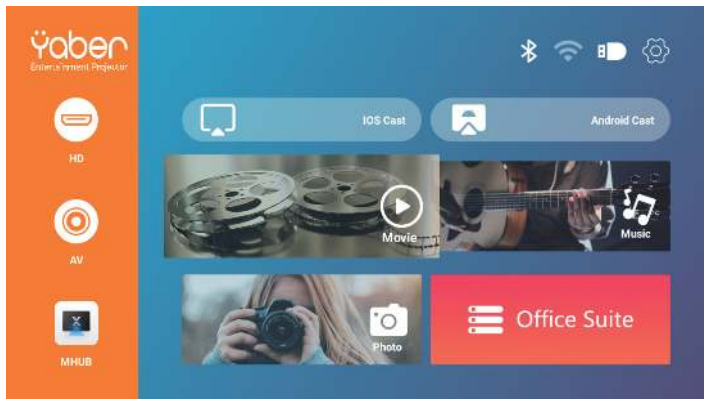

1. Select The Input Signal Source

Select the desired input signal source (HD/AV) on the home-page.

2. USB Disk Insert Mode

2.1. Play Video/Music/Picture/Office in the USB Disk Insert Mode









- 1). Insert the USB Disk, Select the option [Movie/Music/Photo/Office Suite].
- 2). Select the desired file (or folder to enter the subfolder) in the USB disk, then press the [OK] button to play it.

PS:

- a. Buffalo Pro U8 upgraded projector supports U disk to directly play PPT, Word, Excel files.
- b. If you enter from the [Movie] menu, you can only play the video, The same as other 3 options.







2.2.Video Play Interface



Menu	Function
	Switch to the previous video.
	Fast Backward, rewinds the video back quickly while playing it.
	Play or pause the current video.
	Fast Fast, pushes the video move forward quickly while playing it.
	Switch to the next video.
	Select the time when the video starts.
	Select the video list.
	Check the format of the video.
	Repeat the video.





2.3.Music Play Interface

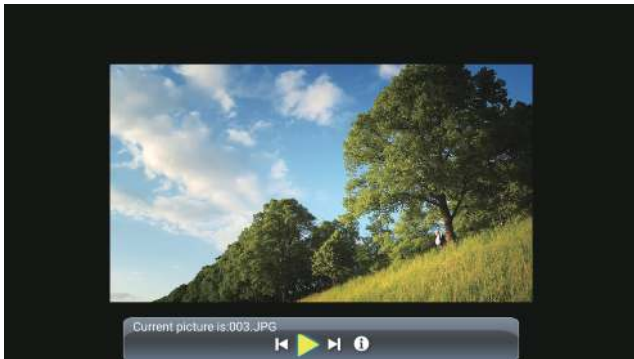

Menu	Function
	Switch to the previous music.
	Play or pause the current music.
	Switch to the next music.
	Repeat the music.
	Select the music list.
	Check the format of the music.

2.4. Picture Play Interface



Menu	Function
	Switch to the previous picture.
	Pause the auto - play mode of a picture.
	Switch to the next picture.
	Check the format of the picture.

3. WiFi Setting

Wireless Connection

Warming Tips:

- ① The fluency of screen mirroring with wireless connection will be affected by the network environment. A bandwidth of 100Mbit or more is recommended when using screen mirroring.
- ② Make sure your mobile device is close to the projector when using wireless connection. A distance within 1 meter is recommended.
- ③ Some mobile devices may not support screen mirroring due to the compatibility.
- ④ Any questions, please feel free to email YABER via aftersales@yabertech.com.

3.1.iOS Cast (for iOS Devices)

1. Turn on the projector, select IOS CAST as the input source to enter the interface of Screen Mirroring for iOS system.

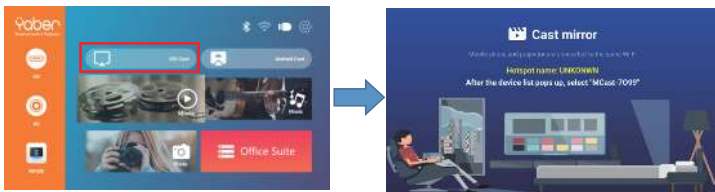

2. Go to the setting of your projector and connect it to your home wifi. Select your home WIFI to make sure that the projector connect to the same wifi to your phone. Press the " ^ " and " v " on the operation panel or remote controller to select the correct WiFi. Press the "OK" key to enter the password page.

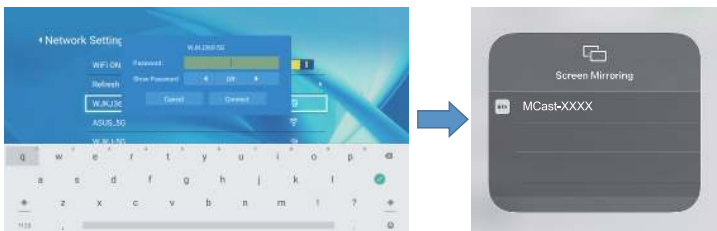

3. Get back to the Wi- Fi setting of your iOS mobile device, then connect it to the same router's Wi-Fi.

4. Swipe up the screen of your iOS mobile device and tap Screen Mirroring to search for the projector, then select MCast-XXXX from the searching results to connect.

5. The display of your iOS mobile device will be projected to the wall/screen via wifi after a successful connection.

3.2.Miracast (for Android Devices)

To activate this function, your android device must support Multi-Screen/Wireless display. Names may differ from different devices. (This function is only available for IOS/ANDROID Devices.)

1. On your Android device, tap [Settings] -[WLAN Display] -Turn [Wi-Fi]ON.
- 2.Turn on the projector, select Android Cast as the Input Source.

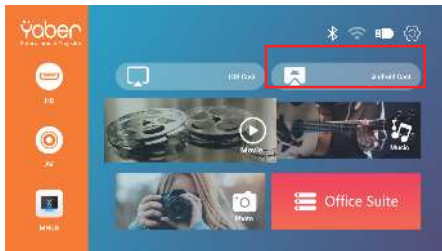

- 3.Select the [Settings] menu on your Android device -- Select the [Screen mirroring] function -- Select your Miracast receiver named [MCast-XXXX] -- your Android device screen will be displayed on the projection screen after 3 seconds.

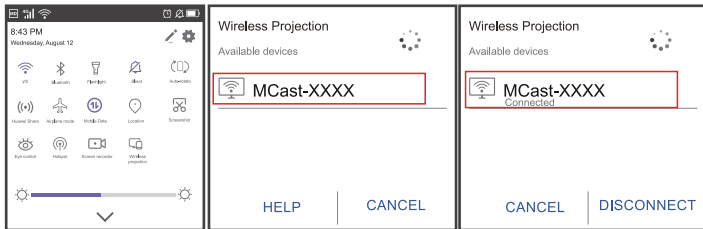

3.3. Control your projector from the app "MHshare TV"

Scan the QR code or learn more on <http://twweb.cvtapi.com/html/tv/maxhub-share-download/> to download the MaxhubShare for your smartphone.



1. Open the app "MHshare TV" and connect to the projector device TV-XXX.
2. The display of your Android mobile device will be projected to the wall/screen via wifi after a successful connection. You can control your projector from the app after the successfully connection.

Note:

1. Different brands of Android phones have different operations for select Screen Mirroring Display, please refer to your phone's manual.
[Multiscreen/Wireless display/WLAN display/Screen mirroring/Wireless projection/Smart view etc.]
2. Not all Android phones support this function. Please make sure it is supported before use.

4. Bluetooth Setting

- (1) Move the cursor to the "Bluetooth" icon and press OK to enter the Bluetooth setting interface.
- (2) Press "OK" on the "Bluetooth ON/OFF" option to turn on and off the Bluetooth function, as shown in the figure below.
- (3) After turning on the Bluetooth function, please scan your Bluetooth devices by clicking the scan button.
- (4) Scan and Select your Bluetooth devices to connect to the projector. Press the "^" and "V" on the operation panel or remote controller to select the correct Bluetooth device. Press the "OK" key to connect.

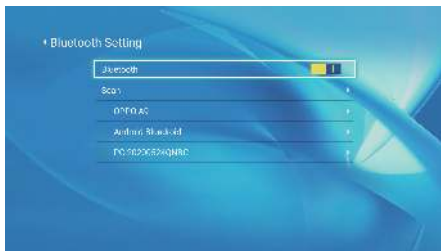

Note:

1. Buffalo Pro U8 projector is compatible with the Bluetooth headsets, Bluetooth speakers and airpods, but not the Bluetooth keyboards or Bluetooth phones.
2. If you have any question, please feel free to email YABER via: aftersales@yabertech.com.

5. Projector Settings

Get a better viewing effect with appropriate settings. The main content of the projection can be set in the following steps.

(1) If needs setting, first select "Settings" on the main screen, and then press the "OK" key on the operation panel.

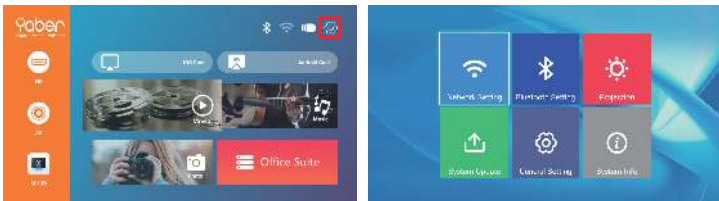

(2) "Network setting", "Bluetooth setting", "Projection", "System Update", "General Setting" can be set. "System Info" can be obtained. Press the "<" and ">" on the operation panel to select the range of settings.

5.1 Network Setting

1. Move the cursor to the "WIFI" icon and press OK to enter the WI-FI setting interface.

2. Press "OK" on the "wifi ON/OFF" option to turn on and off the wifi function, as shown in the figure below.

3. After turning on the wifi function, the projector will search for wifi hotspots automatically.

4. Select your WIFI to make sure that the projector connect to the same wifi to your phone. Press the "^" and "∨" on the operation panel to select the correct WiFi. Press the "OK" key to enter the password page.





5.2 Bluetooth Setting

1. Move the cursor to the "Bluetooth" icon and press OK to enter the Bluetooth setting interface.
2. Press "OK" on the "Bluetooth ON/OFF" option to turn on and off the Bluetooth function, as shown in the figure below.

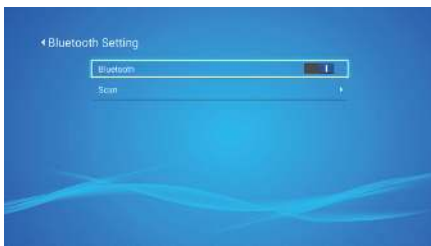

3. After turning on the Bluetooth function, please scan your Bluetooth devices by clicking the scan key.
4. Scan and Select your Bluetooth devices to connect to the projector. Press the "∧" and "∨" on the operation panel to select the correct Bluetooth device. Press the "OK" key to connect.

5.3 Projection Setting

5.3.1.Cast Mode: Front, Rear,Front -Ceiling,Rear-Ceiling

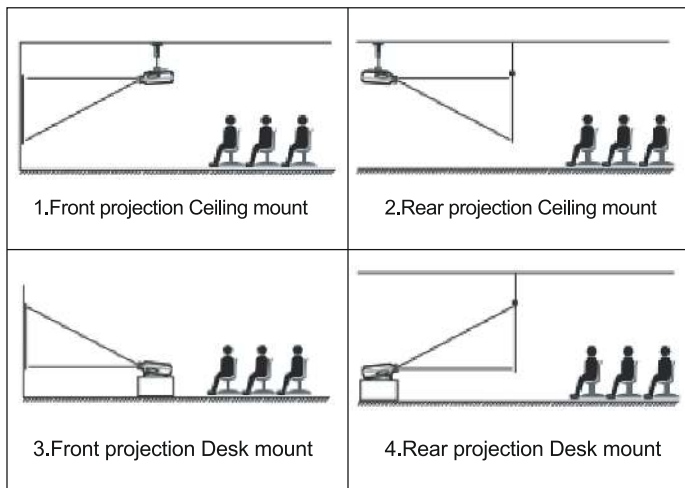
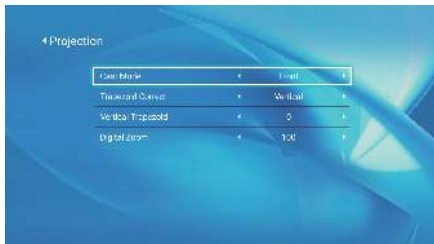

5.3.2.Trapezoid Correct: Quadrangle, Vertical

1) Quadrangle Trapezoid: 0~100

You can enter the setting of Quadrangle Trapezoid to get a better view.

Step 1: Press the button to select the [Quadrangle] menu, then press the [OK] button to enter the submenu.

Step 2: Keep pressing the OK button on the remote controller or projector to select the point.

Step 3: Press the arrow keys on the remote controller or projector to adjust the horizontal or vertical parameters, until the projection screen becomes the desired rectangle.



2) Vertical Trapezoid: -50~50

You can set-up the zoom and vertical trapezoid when you Select the Vertical as the Trapezoid correct mode.

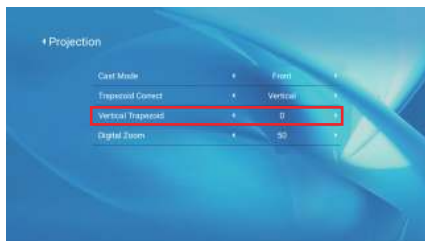

Step 1: Press the button to select the [Vertical] menu, then press the [OK] bottom to enter the submenu.

Step 2: If the projection image shows as (1), press the [Vertical trapezoid] on the remote controller or projector to increase the vertical parameter (-50~0), until to achieve the projection image (2).

Step 3: If the projection image shows as (3), then press the [Vertical trapezoid] the remote controller or projector, and decrease the vertical parameter (0~50), until to achieve the projection image (4).



3) Digital zoom: 50% ~100%

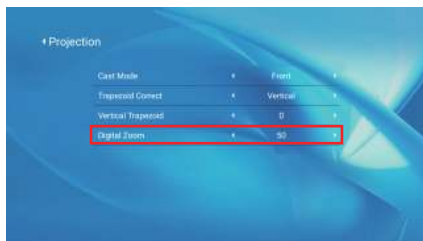

Step 1: Press the button to select the [Digital Zoom] menu, then press the [OK] bottom to enter the submenu.

Step 2: Click the "◀", TURN the Scaling function, you can reduce the height and width of projection size up to 50% in the same proportion.

Step 3: Click the "▶", OFF the Scaling, you can reduce the horizontal ZOOM and Vertical zoom of projection size up to 50% apartly.

5.4 System Update

1.You can online update the system of the projector when you select the Online Update.

2.You can restore to the factory mode by pressing "Restore Factory" if you need to re-set all settings. Please refrain from doing this since it may damage the system.

Note: During the process of restoring factory settings, the projector cannot be powered off or operated, otherwise the system will crash.

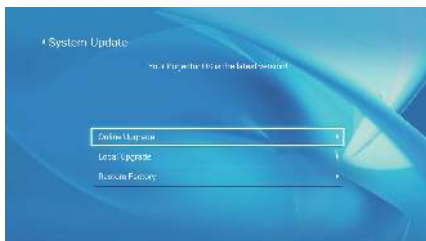

5.5 General Setting

Menu	Function
Power on Option	You can choose to power on standby or direct.
Scheduled Shutdown	You can set the time about the regular shutdown.
Language Setting	You can set the language of the projector, English, Deutsch, France, Italiano, Espano, etc.



SIGNAL LINES CONNECTION

YABER Buffalo Pro U8 projector has 5 interfaces, HD port/ USB ports*2/ AV in/ AUDIO output. Please select the correct connecting port to connect your device (PC, Phone, DVD Player, Sound bar, USB, PS4 etc.)

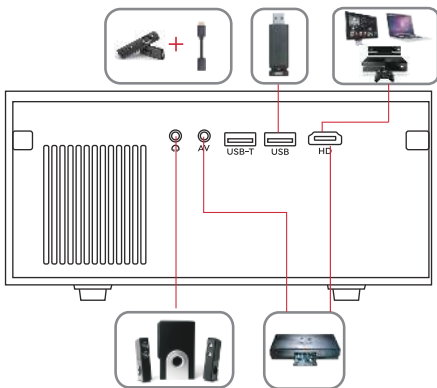

1.Connect USB Disk

- 1) Insert the USB Disk, Select the option [Movie/Music/Photo/Office Suite].
- 2) Select the desired file (or enter the subfolder) in the USB disk, then press the [OK] button to play it.

2.Connect the Devices via the HD ports

- 1) Connect your TV stick or laptop to HD port of the projector.
- 2) Enter the home page to select the corresponding HD as the signal source.

3.Connect to the DVD Player

Use the 3-in -1 AV cable in the package

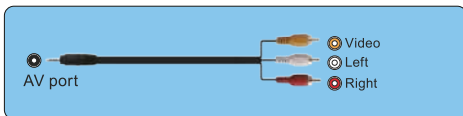
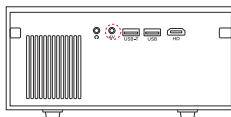

Or connect to the DVD Player with the HD cable in the package.

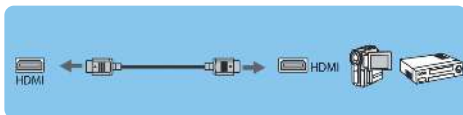
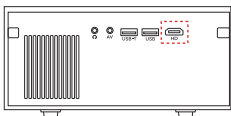

4. Connect to the Sound bar/Speaker

If your speaker has AUX port, please use your 3.5mm audio cable connect the projector and your speaker as the picture shows.

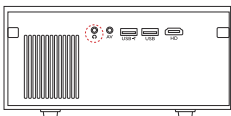

SAFE SHUTDOWN

1. Press the  button on the projector or remote controller, then choose "OK" to power off.
2. Unplug the power cord of the projector.
3. Cover the lens and store the projector in a cool and dry place.

WARRANTY

Thank you so much for your purchase and support! We provide 3-year warranty for Buffalo Pro U8 projector. If you have any questions, please feel free to contact us via aftersales@yabertech.com.

TROUBLESHOOTING

Problems listed below might occur during the operation of your projector. Please refer to the possible factors which might cause the issue to do troubleshooting.

1. When turning on the power switch, the indicator light does not work.

- 1) The power might not be connected well.
- 2) Check the over-heat protection system.

2. The remote control does not communicate with the projector.

- 1) The power switch at the back of the projector is turned on or off?
- 2) The remote control's batteries are depleted?
- 3) Something obstructing the signal between the remote and IR.
- 4) Strong light on IR directly.

3. No image on the screen.

- 1) Is the channel set-up correct?
- 2) Is there an input signal ?
- 3) Is the input cable plugged well ?
- 4) Under PC mode, is the refresh rate > 75KHz ?

4. Blue screen,no picture,no sound.

Input cables connected right?

5. Picture right, no sound.

- 1) Input cables connected right?
- 2) Volume at min or on Mute.

6. Can't play the movies.

- 1) The format of the video is right?
- 2) Files are broken?
- 3) Device is broken?

7. There is picture, no sound?

The decode system doesn't match.

8. Can't find devices when connected with hard drive or flash drive.

Check if the device is broken.

9. Auto-off after working for a while.

- 1) The projector ventilation is blocked.
- 2) The over-heat protection system.

WARNINGS

FCC STATEMENT :

This device complies with Part 15 of the FCC Rules. Operation is subject to the following two conditions:

- (1) This device may not cause harmful interference, and
- (2) This device must accept any interference received, including interference that may cause undesired operation.

Warning: Changes or modifications not expressly approved by the party responsible for compliance could void the user's authority to operate the equipment.

NOTE: This equipment has been tested and found to comply with the limits for a Class B digital device, pursuant to Part 15 of the FCC Rules. These limits are designed to provide reasonable protection against harmful interference in a residential installation. This equipment generates uses and can radiate radio frequency energy and, if not installed and used in accordance with the instructions, may cause harmful interference to radio communications. However, there is no guarantee that interference will not occur in a particular installation. If this equipment does cause harmful interference to radio or television reception, which can be determined by turning the equipment off and on, the user is encouraged to try to correct the interference by one or **more of the following measures:**

Reorient or relocate the receiving antenna.

Increase the separation between the equipment and receiver.

Connect the equipment into an outlet on a circuit different from that to which the receiver is connected.

Consult the dealer or an experienced radio/TV technician for help.

FCC RADIATION EXPOSURE STATEMENT:

This equipment complies with FCC radiation exposure limits set forth for an uncontrolled environment. This equipment should be installed and operated with minimum distance 20cm between the radiator & your body.

This device contains licence-exempt transmitter(s)/receiver(s) that comply with Innovation, Science and Economic Development Canada's licence-exempt RSS(s). Operation is subject to the following two conditions:

- (1) This device may not cause interference.
- (2) This device must accept any interference, including interference that may cause undesired operation of the device.

WARNINGS



Correct Disposal of this product

Do not dispose this product as unsorted municipal waste.

Collection of such waste separately for special treatment is necessary.

DECLARATION OF CONFORMITY

We (Manufacturer is responsible for this declaration)

YABER TECHNOLOGIES CO.,LIMITED.

(Company name)

Room 406,4 Floor,B Building,BanTian International Center,HuanCheng South Road,Ban-Tian Street, LongGang District,Shenzhen, China

(Company address)

declare under our sole responsibility that the product

Trade name: YABER

Equipment: Entertainment Projector

Model No. : Buffalo Pro U8

to which this declaration relates is in conformity with the essential requirement set out in the Council Directive on the Approximation of the laws of the Member States relating to RED Directive(2014/53/EU) & RoHS(2011/65/EU) product is responsible to affix CE marking, the following standards were applied:

EN 62368-1:2014+A11:2017

EN IEC 62311:2020

ETSI EN 301 489-1 V2.2.3(2019-11)

ETSI EN 301 489-17 V3.2.4(2020-09)

ETSI EN 301 489-3 V2.1.1(2019-03)

EN 55032:2015+A11:2020

EN 55035:2017 +A11:2020

EN IEC 61000-3-2:2019

EN 61000-3-3:2013+A1:2019

ETSI EN 300 328 V2.2.2(2019-07)

ETSI EN 301 893 V2.1.1(2017-05)

ETSI EN 300 440 V2.2.1(2018-07)

IEC62321-3-1:2013

IEC62321-4:2013

IEC62321-5:2013

IEC62321-6:2015

IEC62321-7-1:2015

IEC62321-7-2:2017

IEC62321-8:2017

Full Name: George.wang

Signature: George.wang

Position: Approbation Manager

Place/Date: Shenzhen,China/Jun.15-2022



 www.yaberglobal.com

 aftersales@yabertech.com

 @Yaber Entertainment Projector

 @Yaber Entertainment Projector