

6000A Play User Manual

audiolab

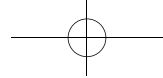

1 : Important Safety Information



This lightning flash with arrowhead symbol within an equilateral triangle is intended to alert the user to the presence of non-insulated “dangerous voltage” within the product’s enclosure that may be of sufficient magnitude to constitute a risk of electric shock.

Warning: To reduce the risk of electric shock, do not remove cover (or back) as there are no user-serviceable parts inside. Refer servicing to qualified personnel.

The exclamation point within an equilateral triangle is intended to alert the user to the presence of important operating and maintenance instructions in the literature accompanying the appliance.

IMPORTANT SAFETY INSTRUCTION

Read these instructions.

Keep these instructions.

Heed all warnings.

Follow all instructions.

Do not use this apparatus near water.

Clean only with dry cloth.

Do not block any ventilation openings. Install in accordance with the manufacturer’s instructions.

Do not install near any heat sources such as radiators, heat registers, stoves, or other apparatus (including amplifiers) that produce heat.

Do not defeat the safety purpose of the polarized or grounding-type plug. A polarized plug has two blades with one wider than the other. A grounding plug has two blades and a third grounding prong. The wide blade or the third prong is provided for your safety. If the provided plug does not fit into your outlet, consult an electrician for replacement of the obsolete outlet.

Protect the power cord from being walked on or pinched particularly at the plugs, convenience receptacles, and at the point where they exit from the apparatus.

Unplug this apparatus during lightning storms or when unused for long periods of time.

Refer all servicing to qualified service personnel. Servicing is required when the apparatus has been damaged in any way, such as power supply cord or plug is damaged, liquid has been spilled or objects have fallen into the apparatus, the apparatus has been exposed to rain or moisture, does not operate normally, or has been dropped.

CAUTION: These servicing instructions are for use by qualified service personnel only. To reduce the risk of electric shock, do not perform any servicing other than that contained in the operating instructions unless you are qualified to do so.

Do not install this equipment in a confined or built-in space such as a bookcase or similar unit, and keep well ventilated in open space. The ventilation should not be impeded by covering the ventilation openings with items such as newspaper, table-cloths, curtains etc.

WARNING: Only use attachments/accessories specified or provided by the manufacturer (such as the exclusive supply adapter).

WARNING: Please refer to the information on the exterior panel of the enclosure for electrical and safety information before installing or operating the apparatus.

WARNING: To reduce the risk of fire or electric shock, do not expose this apparatus to rain or moisture. The apparatus shall not be exposed to dripping or splashing and that objects filled with liquids, such as vases, shall not be placed on apparatus.

WARNING: For the terminals marked with symbol of “⚡” the voltage may be of sufficient magnitude to constitute a risk of electric shock. The external wiring connected to the terminals requires installation by a qualified person or the use of ready-made leads or cords.

The product is designed to use in moderate/tropical climates.

Mains Supply: The mains operating voltage of Audiolab 6000 series units is shown on the rear panel. If this voltage does not match the mains voltage in your area, consult your Audiolab dealer about converting the unit.

The mains supply fuse on the rear panel is accessible when the IEC mains plug has been removed. In the rare event that it has broken, check for any obvious cause before replacing the fuse with one of the correct rating and type.

The fuse values are:

220 – 240V (UK, China, etc.) T2AL 250V Slow Blow

100 – 120V (USA, Japan, etc.) T4AL 250V Slow Blow



This equipment is a Class II or double insulated electrical appliance. It has been designed in such a way that it does not require a safety connection to electrical earth.

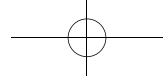

2: Contents

audiolab
6000A Play

GETTING STARTED	4
CONTROLS AND FUNCTIONS	5
REMOTE HANDSET	6
CONNECTIONS	7
SYSTEM OPERATIONS	8
DTS PLAY-FI® WIRELESS STREAMING TECHNOLOGY	11
DOWNLOAD THE APP	12
WI-FI CONNECTION USING THE APP	13
WI-FI CONNECTION SETUP USING A WINDOWS PC OR MAC	14
APP OPERATIONS	15
WARRANTY	19
SPECIFICATIONS	20

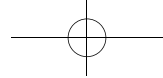

3: Getting Started

Page 4

Introduction to Audiolab 6000 Series

Welcome to the Audiolab 6000A Play, an integrated amplifier with wireless audio streaming, which is the latest member of the acclaimed Audiolab 6000 series of components. Featuring DTS Play-Fi Technology, music can be streamed over your wireless network in high resolution format and can be easily expanded to a multi-room system if required. You can stream from any source on your wireless network, including smart-phones, tablets or PCs as well as a NAS Drive. However you want to stream your music, Audiolab's 6000A Play will deliver an outstanding performance.

The 6000A Play features analogue and digital audio circuitry of the highest quality and has been designed by engineers who are passionate about the reproduction of music, and we hope you will enjoy its performance for many years to come.

Please read through this manual to obtain the very best performance from your 6000A Play.

Features:

- DAC - ES9018K2M
- Dedicated high performance MM phono input
- Separate pre-power sections for flexibility of operation
- Automatic equipment activation via 12V trigger
- Auto standby function
- Wireless audio streaming with DTS Play-Fi technology
- Bluetooth aptX receiver

Inputs:

- Three analogue line level inputs
- One phono input (MM)
- One power-amp input
- Two coaxial SPDIF digital inputs
- Two optical SPDIF digital inputs

Outputs:

- Pre-amplifier output
- Loudspeaker output
- Headphone output

Unpacking The Equipment

The carton should contain:

- The Audiolab 6000A Play
- One IEC power cord suitable for your area
- One remote handset
- One instruction manual

Please note: The remote control requires 2 x AAA type batteries. Due to international shipping and courier regulations with Lithium Ion batteries, the remote controller battery is not included in this package.

Consult the dealer from whom you purchased the equipment if any item is not present. Carefully unpack the unit and accessories. Take care not to damage the surface finish when undoing the protective polythene sleeve. Retain the packing materials for future use. Retain the user manual and information concerning the date and place of purchase of your equipment for future reference. If you transfer the unit to a third party please pass on this instruction manual along with the equipment.

Placement

The unit must be mounted on a solid, level and stable surface.

Before you connect the Audiolab 6000A Play to the AC mains power, ensure your AC mains voltage corresponds to the rating on the rear panel of the product. If in doubt, consult your dealer. If you move to an area which has a different mains voltage, seek advice from an Audiolab appointed dealer or a competent service technician.

4: Controls and Functions

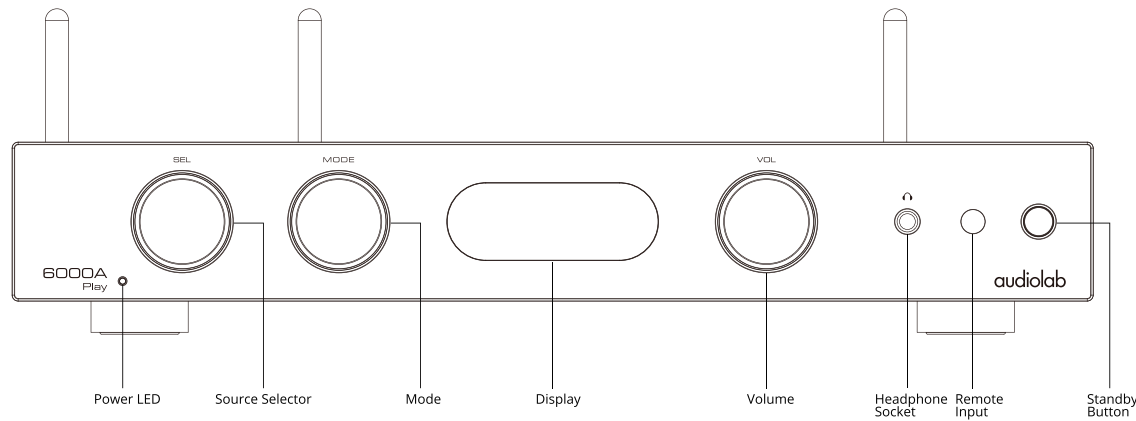

Device States	WiFi LED States(red)	Power LED States
Standby Mode	Off	Dark red
Initialization Mode	Fast flash	Fast flash white
Standard Setting Mode	Slow breathe	Slow breathe white
WPS Mode	Double flash	Double flash
Network Connecting	Slow flash	Slow flash white
WiFi Network Connection	Brightly lit	Bright white
Wired Network Connection	Off	Bright red

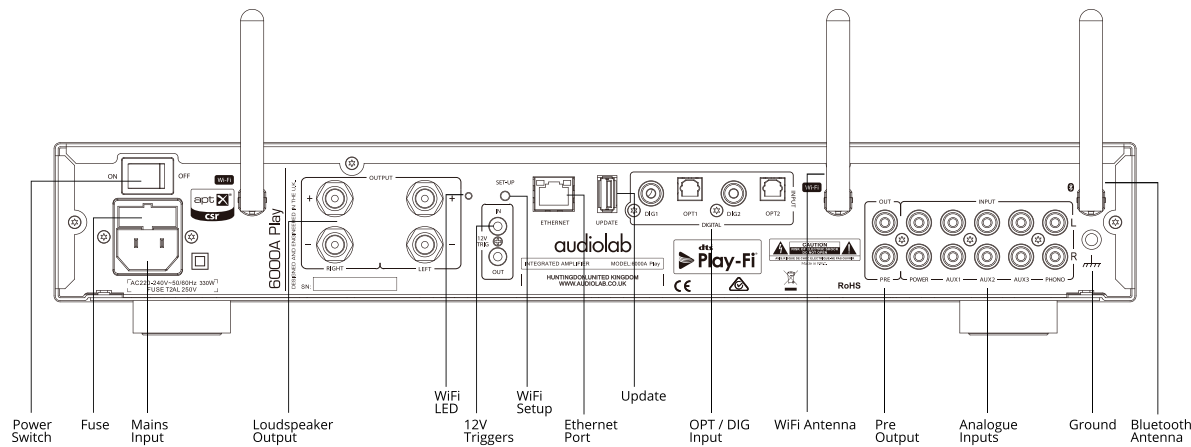

5: Remote Handset

NOTE : the handset buttons shown crossed out are for use with other Audiolab units like Audiolab 6000CDT and are not operational when used with the 6000A Play

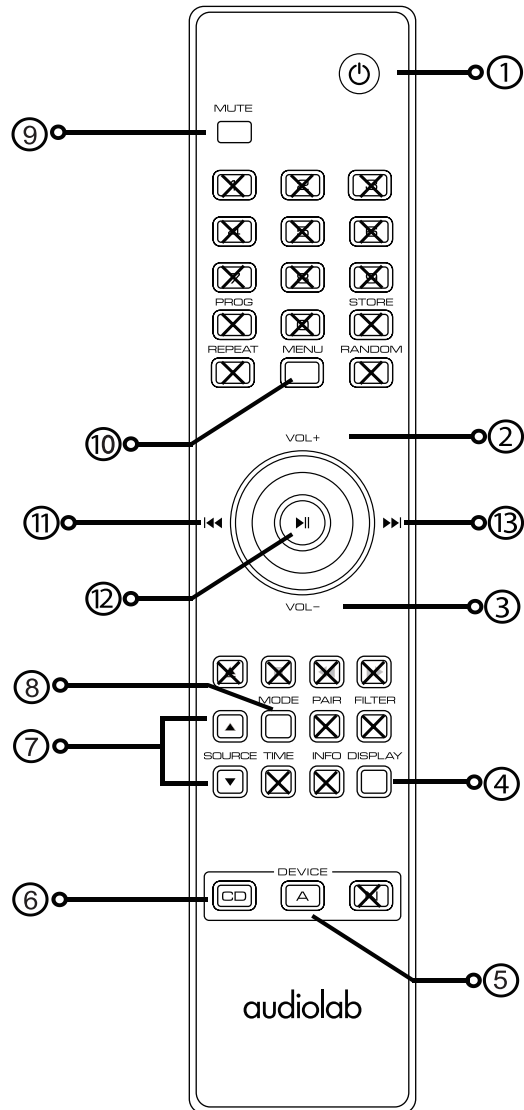

- 1 STANDBY Press to bring the unit in/out of standby
- 2 VOL+ Increase volume
- 3 VOL- Decrease volume
- 4 DISPLAY Press to toggle the display on/off
- 5 A Press to select 6000A Play remote mode
- 6 CD Press to select 6000CDT remote mode
- 7 SOURCE Press to cycle source inputs
- 8 MODE Press to select 6000A Play operating mode
- 9 MUTE Press to mute and unmute the sound
- 10 MENU Press to enter menu
- 11 ◀◀ Move to the previous track
- 12 ▶▶ Move to the previous page or setting in menu
- 13 ▶▶ Move to the next track
- ▶▶ Move to the next page or setting in menu

Fitting Batteries

The remote control requires 2 x AAA type batteries. Due to international shipping and courier regulations with Lithium Ion batteries, the remote controller batteries are not included in this package.

Always use AAA batteries and replace them in sets -never mix old and new batteries.

Handset Operation

The handset operates several Audiolab components. The handset buttons shown crossed out are for use with other Audiolab units and are not operational when used with the 6000A Play.

Point the handset at the remote receiver and press the relevant key. The handset should be within 15 meters of the player and there must be a clear line of sight between the two units.

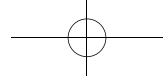

6: Connections

Analogue Inputs (Line Level)

Connect your analogue sources to one of the three line level inputs, AUX1, AUX2 or AUX3.

Phono Input (MM)

Connect your turntable (moving magnet cartridge) to the phono input. Connect the Earth lead from your turntable (if available) to the GROUND terminal.

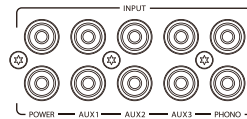

Coaxial Digital Inputs

Connect your coaxial digital sources to either DIG1 or DIG2.

Optical Digital Inputs

Connect your optical digital sources to either OPT1 or OPT2.



Pre-Amplifier Output

Pre-amplifier output for driving external power amplifiers, subwoofers or signal processors.

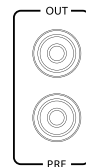

Loudspeaker Terminals

One set of loudspeaker output terminals.

Headphone Output

A stereo 6.3mm (1/4") jack is provided on the front panel for connecting headphones.

When headphones are connected the audio to the loudspeakers terminals will be cut off.

Bluetooth Connection

Select BT source on the 6000A Play, on your mobile device search for 'Audiolab 6000A Play BT' and connect.

Once paired the front panel SOURCE indicator will be turned on. If you switch to another input on the 6000A Play your mobile device will be disconnected after 60 sec. To reconnect, select BT on the 6000A Play and it will connect to the last paired device, or select 'Audiolab 6000A Play BT' on your mobile device in the Bluetooth menu and it will reconnect.

USB Update

Put the update file into USB drive, plug in the UPDATE USB interface, press STANDBY button on the front panel then POWER ON, 6000A Play will upgrade automatically. After the completion, unplug the USB drive and restart the device, now it can be used.



ETHNERNET Port

Use a suitable cable to plug the Ethernet Port to the LAN port of a wireless router for wired connection. It is recommended to use a wired connection when playing high resolution audio, which makes the playback more stable and smooth.

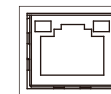

12V Trigger Connections

The 6000A Play features two 12V trigger connections, one output and one input. Use the output to control other products (ie. Audiolab amplifiers or 3rd party compatible equipment). Use the input when the 6000A Play is to be controlled (ie. by Audiolab 6000CDT, or 3rd party compatible equipment).

The trigger connections are made using 3.5mm to 3.5mm jack interconnects (not incl.).

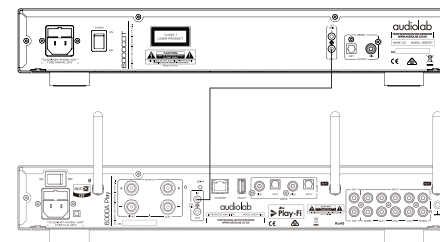

Mains Input

Before connecting the AC power cord to the 6000A Play, please make sure the Power Switch is in the OFF position. Switch it to the ON position after connecting the unit to the AC mains.

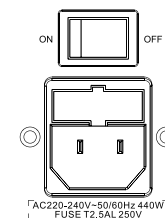

AC220-240V-50/60Hz 440W FUSE T2.5AL 250V

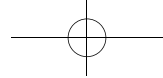

7: System Operations - 1

Switching On and Off

Switch on all source units before switching on power to the 6000A Play.

When switching On: the power LED illuminates.

When switching Off: switch off the 6000A Play before the source units.

Standby Mode

The 6000A Play will enter standby mode after being powered on. Press the "Standby" button to bring the 6000A Play out of standby, the power indicator LED becomes brighter and the display shows "6000AP" welcome screen while the unit is getting ready for operation.

The Auto Standby feature will, by default, put the unit into standby after 20min of inactivity.

This feature can be configured using the MENU (see page 8) and can be set to 20 minutes , 1 hour or Never.

Source Select

Rotate the SEL knob on the front panel or use the source buttons on the remote handset to select different source inputs.

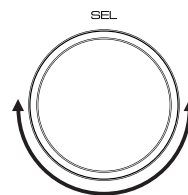

Volume Control

Rotate the VOL knob on the front panel, or use the Volume up/down keys on the remote control, to set the volume level. The range is -78dB to +8dB, the factory default volume setting is -20dB. When coming out of standby the 6000A Play will be set to the previous used volume setting, except if louder than -30dB, in which case the volume will default to -20dB.

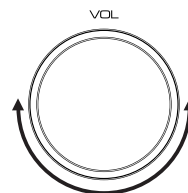

Mute

Press the VOL knob on the front panel or the MUTE button on the remote handset to mute / un-mute the sound.

Display Setting

The DISPLAY button on the remote control will toggle the front panel display ON/ OFF.

When the display is OFF: using the front panel controls or pressing any remote key will momentarily turn on the display, after 5 seconds. the display will go off.

Digital Filter Selection (DAC)

The DAC in the 6000A Play has a choice of 3 digital filters. Press the MENU key on the remote control to access the FILTER options (see page 8 for further details)

- Filter = Fast : Standard flat response with fast frequency roll off above $F_s/2$ (half the sampling frequency)
- Filter = Slow: Starts rolling off at a lower frequency than the Fast filter but has a more gentle rate of attenuation.
- Filter = Phase: Has a gentle attenuation slope similar to the Slow filter but with minimum phase characteristics. It can be likened to an analogue filter applied in the digital domain.

Operating Mode

Although the 6000A Play is an integrated amplifier it can function as a separate pre and power amplifier.

Use the MODE knob on the front panel, or the MODE key on the remote control, to select different operating modes.

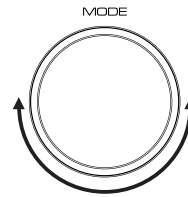

MODE	POWER AMP IN	PRE OUT	HEADPHONE OUT	LOUDSPEAKERS
PRE	DISABLE	ACTIVE	ACTIVE	DISABLE
PRE-POWER	ACTIVE	ACTIVE	ACTIVE	ACTIVE
INTEGRATED	DISABLE	ACTIVE	ACTIVE	ACTIVE

Integrated Mode

The pre-amplifier section is internally connected to the power amplifier, pre-amplifier output is also operational in this mode. A second power amplifier can be connected for bi-amplification as shown in the diagram.

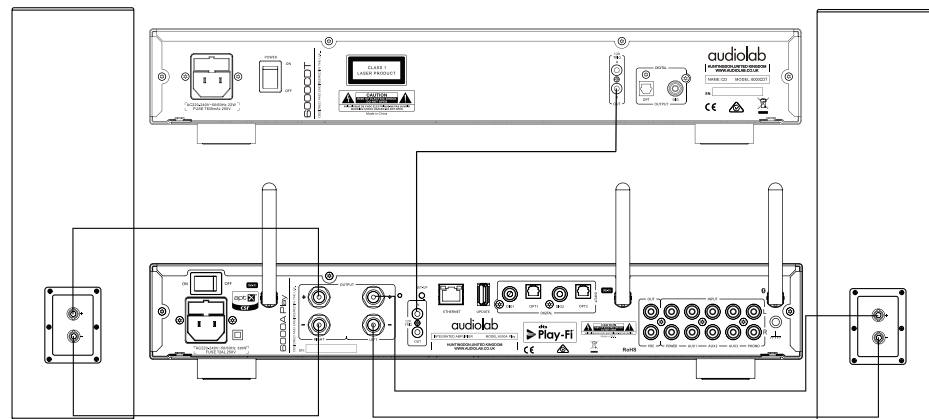

Pre-Power mode

The pre-amplifier section is internally disconnected from the power amplifier. The 6000A Play can be used as a stand alone power amplifier (ie. part of an AV setup). This mode can also be used if additional signal processing is required, connecting the pre-out to an external signal processor and then take the output from the processor to the 6000A Play Power-IN.

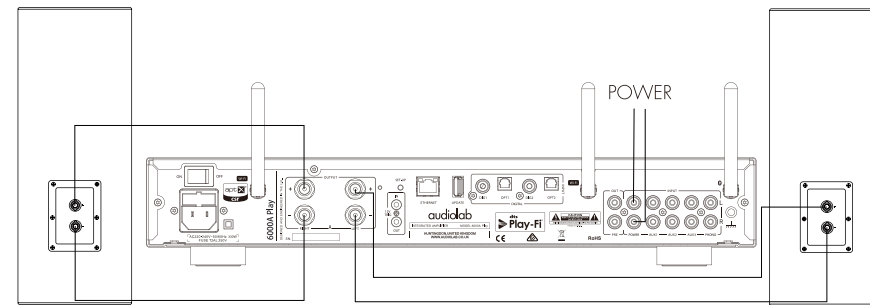

Pre Mode

All signals to and from the power amplifier of the 6000A Play are disconnected. In this mode, the 6000A Play functions as a stand-alone pre-amplifier. The pre-amplifier section of the 6000A Play can be connected to a stereo power amplifier, or to two mono-block amplifiers.

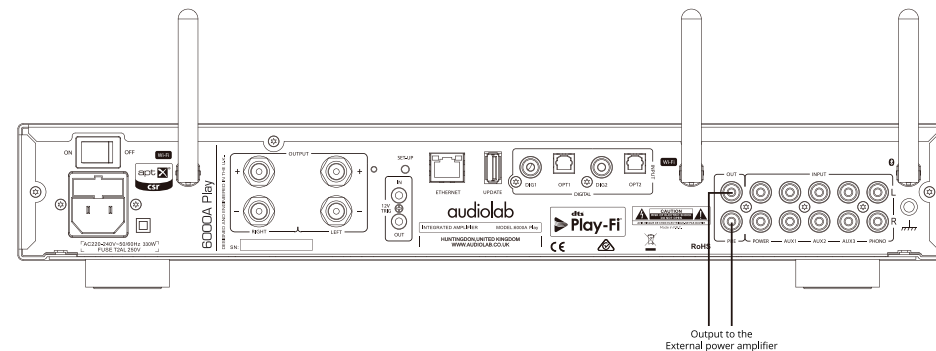

The MENU

The menu enables you to customize the unit and optimize the interface with other equipment in your system.

6000A Play has 8 different menu pages. Press the MENU key on the remote control to enter menu mode, and then press ◀◀ or ▶▶ to turn to different menu pages. Press ▶|| to enter any menu page, press ◀◀ or ▶▶ again to select different settings.

You can also press the MODE knob on the front panel to enter the menu mode. Pressing the MODE knob on the front panel can also enter the menu mode. Rotate this knob turns through the menu pages. Press the MODE knob again to enter any menu page and rotate the knob to change the setting. Press the MODE knob again to select a setting.

No operation for 5 seconds will also exit menu mode automatically.

The Menu Tree

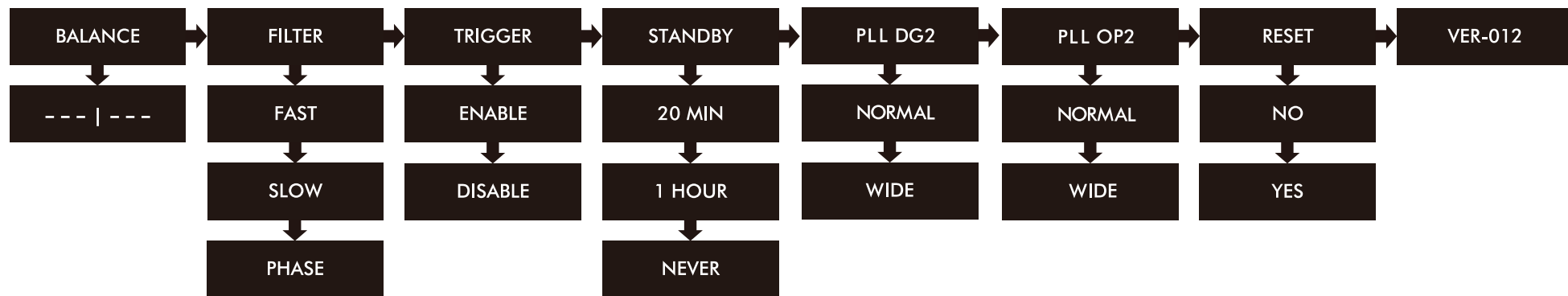

Key Features

DTS Play-Fi puts you in complete control of your music. It gives you the freedom to effortlessly stream via Wi-Fi® from any device to any speaker in any room in your house. It's never been easier to listen to music with the people you love, in the place you love most. A place where memories are made and music plays the starring role.



WI-FI® TECHNOLOGY

DTS Play-Fi streams music over standard Wi-Fi networks, delivering perfectly synchronized audio, with no lag and zero loss in sound quality.

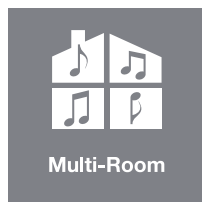

MULTI-ROOM

Enjoy music in every room of your house — all at once, perfectly synchronized, with no lag. You're in control.

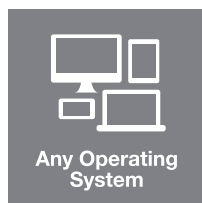

ANY OPERATING SYSTEM

Fully compatible with all operating systems: Apple iOS, Android™, Windows® PC, and Fire OS.

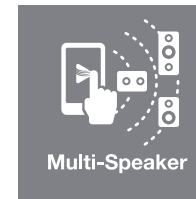

MULTI-SPEAKER

DTS Play-Fi is open to all speakers, no matter the size, shape, or brand. It's a truly all-inclusive system.

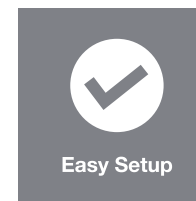

EASY SETUP

No logins, no complicated computer-based setups. Just download the app and within minutes, you're ready to listen.

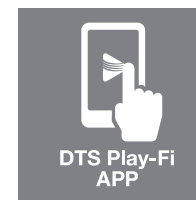

DTS PLAY-FI APP

Simply download the free app and immediately send songs via Wi-Fi to any speaker in any room of the house.

For DTS patents, see <http://patents.dts.com>. Manufactured under license from DTS Licensing Limited. DTS, Play-Fi, the Symbol, and Play-Fi together in combination with the Symbol are trademarks of DTS, Inc. DTS and Play-Fi are registered trademarks of DTS, Inc. © DTS, Inc. All Rights Reserved.

Download the DTS Play-Fi APP

The DTS Play-Fi APP can be downloaded from the Google Play Store, Amazon APP Market or Apple App Store. For Windows PC you can download the Play-Fi Windows APP from the official website: <https://play-fi.com>



Network Settings

Wired network setting

Connect the Ethernet Port to the LAN port of a wireless router using a suitable cable. After switching on the 6000A Play, the white LED on the front panel and red Wi-Fi LED on the rear panel will fast-flash during the initialize phase of Wi-Fi mode. The LED change from white to red on the front panel and slow-flash when the device is connected to the wired network connection. If the connection is successful, the red Wi-Fi LED will go off, but the red LED on the front panel stays lit.

Wireless Network Setting

You can connect to a wireless network using one of two modes: WPS Mode or Standard Mode.

WPS Mode:

In order to make the 6000A Play enter WPS Mode, switch the unit on and press and hold the Wi-Fi SET-UP button on the rear panel for 4 seconds. The Wi-Fi LED will double-flash and beep with a warning tone indicating that WPS Mode is active. Then briefly press the WPS key on your wireless router and the unit should connect to your wireless network automatically. This connection phase may take up to 60 seconds. If the connection fails, please try again.

Standard Mode:

After switching the 6000A Play on, press and hold the Wi-Fi SET-UP button on the rear panel for 8 seconds. For the first 4 seconds the Wi-Fi LED will double-flash and beep with a warning tone - keep holding the button down and after 8 seconds the Wi-Fi LED will flash quickly and also beep with a warning tone. The Standard connection mode is now active and the Wi-Fi hotspot will be found after 20 seconds. Then the Wi-Fi LED will flash-breathe with a slow fluctuation between off and on (reflected by the white LED on the front panel). You can now use your Android or IOS device to enter the Wi-Fi password using the Play-Fi APP as follows (see next page):

10: Wi-Fi Connection Using the APP

For Andriod users:

- (1) Open the DTS Play-Fi APP, then click the 'Set-up your Play-Fi device' button.
- (2) When it has found the 6000A Play click the 'Set-Up' button. Next input the Wi-Fi password for your wireless network. Then click the 'Next' button.
- (3) During installation the APP will find and upgrade the 6000A Play-Fi settings which may take a few minutes.
- (4) After completing the network setup and upgrading you can set a name for your 6000A Play Device and use it.

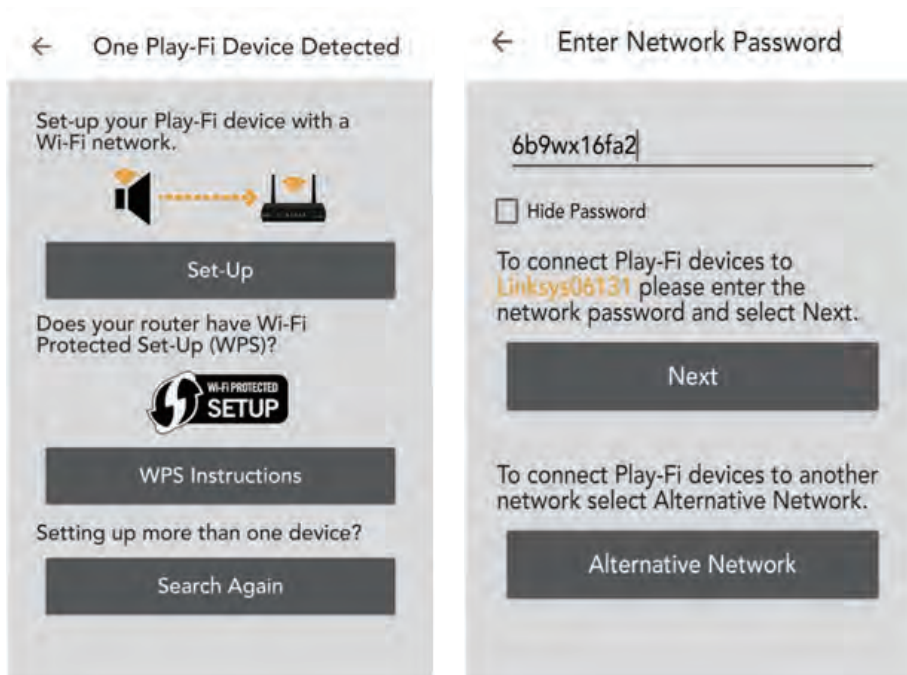

For Apple iOS users:

- (1) Download the Play-Fi APP. Before opening the APP please switch to the Settings - Wi-Fi menu on your smartphone or tablet and select 'PlayFiXDeviceXXXXXX' from the options.
- (2) Open the Play-Fi APP and find the 6000A Play-Fi Device name. Select it and enter your wireless network password.

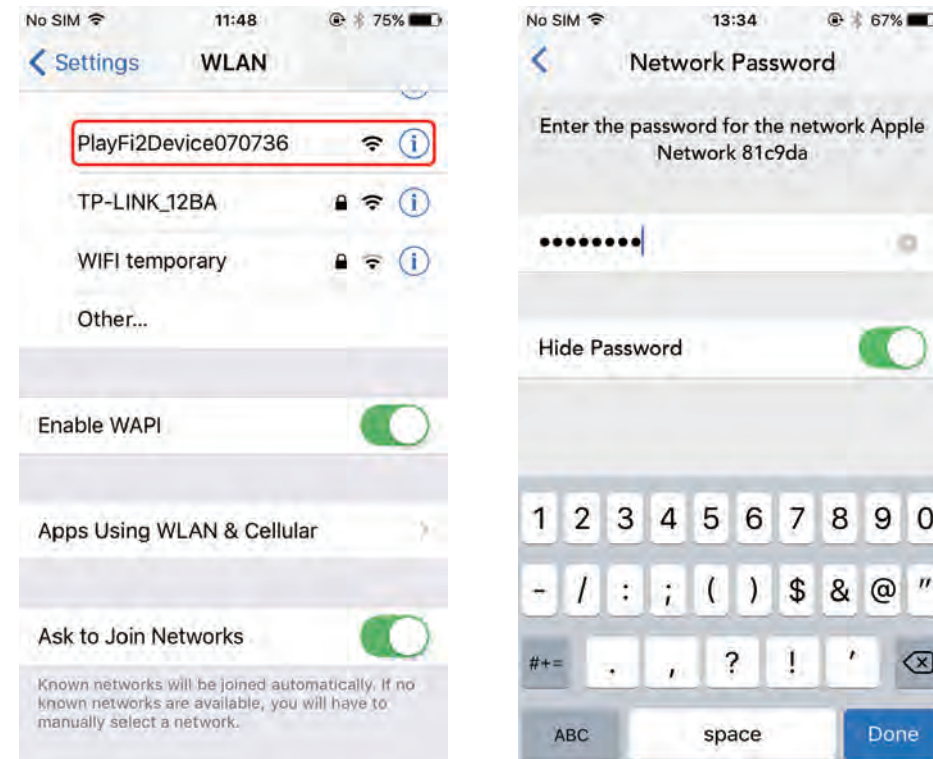

- (3) During installation the APP will find and upgrade the 6000A Play-Fi settings which may take a few minutes.
- (4) After completing the network setup and upgrading you can set a name for the 6000A Play Device and use it.

For PC or Mac users:

If you cannot connect using the DTS Play-Fi APP, or you need to do some high-level option such as setting the static IP configuration, you can setup the Audiolab 6000A Play using a web browser from your Windows PC or a Mac.

Set the 6000A Play to Standard Setup mode, then follow these steps:

- (1) Connect your computer to the wireless Wi-Fi of the 6000A Play - it will show as 'PlayFiXDeviceXXXXXX' or similar name. After connecting your computer may show 'No Internet Connection' - this is normal.
- (2) Open your Internet Browser and type: 192.168.0.1/index.html in the address bar.
- (3) Click the Enter key or click 'Continue' option in your Internet Browser.
- (4) This will open the Play-Fi configuration.
- (5) Select the 'Set Up' button.

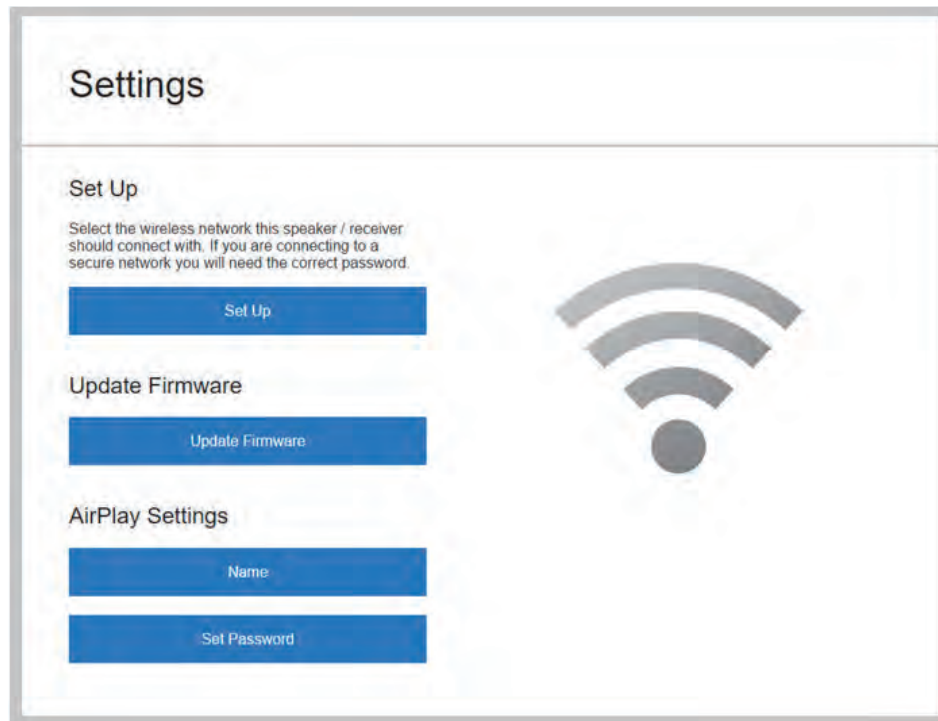

- (6) Select your wireless router Wi-Fi network.

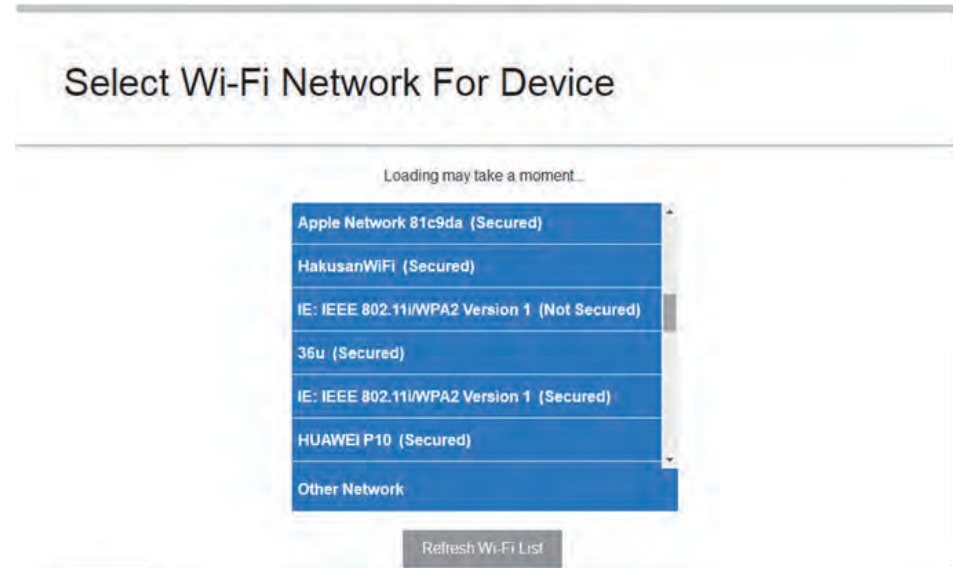

- (7) Enter the password for your wireless network. Then click the 'NEXT' button.



- (8) You can then name your 6000A Play Device and click 'NEXT'. The Wi-Fi connection will be made and you can use the device.

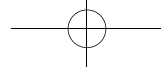

Device Selection

The DTS Play-Fi APP allows you to control and direct streaming music to a variety of Devices throughout your home that use the DTS Play-Fi system. You can set each Device to have a unique name. You can also group Devices into an Area, where each Device will play the same music.

To select a Device and Area using the APP, click the '+' icon on the upper right corner of the APP display. Select an Area to add, then select a Device on which to play the music. If you wish to play high-resolution audio files, the icon 'Hi-Res AUDIO' should be selected.

Music Services

DTS Play-Fi supports the world's most popular and exciting streaming music services, so you can enjoy your favorites at home just as easily as you do in the gym. See below for more information of streaming music service platforms. Please feel free to choose one you like. (Note: some streaming music service platforms probably need to be registered.)

Amazon Music

Amazon Prime members can use Amazon's popular music service for free. A growing selection of over 2 million songs is always ad-free and on-demand, with curated playlists, personalized stations and unlimited skips. Upgrade to Prime Music Unlimited, and enjoy 10 million songs, weekly new releases, and more.



Deezer

With 43 million tracks, 100 million playlists, and a presence in 182 countries, Deezer literally covers the globe for its subscribers. Subscriptions start at \$9.99/month, and include ad-free playback, premium audio quality, and more.



iHeartRadio

iHeartRadio combines access to over 1,500 of the most popular live terrestrial and internet radio stations with unique live events and compelling custom features, like artist radio, personalized radio, and on-demand podcasts for FREE. Their new Plus and All-Access subscriptions allow you to pause, rewind, skip and save live radio content, stream on-demand music, and more.



Internet Radio

DTS Play-Fi has a built-in Internet Radio service that gives you access to thousands of radio stations and podcasts from around the globe. Instantly see your local favorites, or tune into the BBC, ESPN, Radio Disney, the Wall Street Journal, and more. Browsing is a snap, and if you find a station you love, just give it a star and it'll be ready to stream whenever you are. Free, no subscription required.



Juke

With more than 20 million tracks and a dedicated base of music fans, Juke's streaming service includes popular features like on-the-go playlists, new music discovery, and ad-free listening. DTS Play-Fi is the only multi-room audio platform to offer the Juke service.



KKBox

KKBox is Asia's leading streaming music service, with over 30 million tracks from 500 local and major labels, and the most comprehensive collection of Asia-Pop in the world. Featuring both free and premium options, the service also includes mood-based programming and supplemental content including music news, videos, concert updates and more.



On Device Music

DTS Play-Fi puts your mobile music collection at your fingertips, automatically finding and indexing the songs stored on your device. You can browse and stream by album, artist or genre, and even use your existing playlists. DTS Play-Fi supports local files in multiple formats, from MP3 all the way up to premium CD and lossless quality encoding. Free, with no subscription required.



Media Server

Got a hard drive full of music? Avid digital collectors can access and stream from media servers using DTS Play-Fi. The system automatically discovers and indexes music from DLNA and UPnP servers on your network. You can select and stream files in multiple formats via DTS Play-Fi, including premium tracks encoded at CD quality or even 24-bit/192kHz lossless content. No subscription required.

Napster

Napster integrates the heritage of streaming market pioneer Rhapsody into its premium, ad-free on-demand service. With 30 million tracks, instant playlist creation, and anytime, anywhere access, Napster is justifiably popular on multiple continents with millions of subscribers.

Pandora

Listen free to music you'll love, as Pandora's streaming service evolves with your tastes. Give songs a thumbs up or down, and your stations become more personal the more you listen. Enjoy the service at no charge with ads, upgrade to Pandora Plus for commercial-free streaming, or try Pandora Premium to add on-demand features and premium sound quality to your experience.

Qobuz

Based in France, Qobuz was founded and built around a premium audio quality experience. It boasts 70,000 albums available for streaming at 24/192, with many more streaming at 16/44 CD quality. The service also features in-depth artist profiles and editorial content.

QQMusic

China's largest music streaming service offers tens of millions of tracks and thousands of radio stations to its 400 million monthly active users. With free and premium tiers, and both local and international content, QQ Music is a dominant force in music listening in China.

SiriusXM

With over 150 channels of commercial-free music plus sports, talk, comedy, entertainment, news and more, it's no wonder that Sirius XM is one of the most widely used premium streaming services in North America. It's a snap to go from listening in your car to listening at home with DTS Play-Fi.

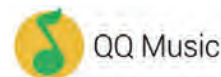

SoundMachine

Business never sounded so good! Whether it's in an office or a restaurant, a retailer or a hotel, background music enhances both the customer and the employee experience. Hundreds of stations and millions of songs, including the ability to create artist stations, so you can design the perfect sound for your brand. Fully licensed for business environments.



Spotify

Their motto is "Music for Everyone", and with millions of listeners around the globe, Spotify seems to be onto something. Create and share playlists, or choose from thousands of curated collections. Spotify Premium subscribers can stream directly to any DTS Play-Fi enabled speaker directly from the Spotify App. Available in the US and more than 50 other countries. The Spotify Software is subject to third party licenses found here:

www.spotify.com/connect/third-party-licenses.

Use your phone, tablet or computer as a remote control for Spotify. Go to spotify.com/connect to learn how



Tidal

High Fidelity Music Streaming is Tidal's hallmark. Every track on the service streams in premium audio format, with most in lossless CD quality or above. The service also boasts many exclusive new releases, artist-curated stations and in-depth features designed to complement the music offerings. Available to DTS Play-Fi users in the US and more than 50 other countries.



In addition to the support listed above, it also supports music services such as BBC, ESPN RADIO, HD tracks, NPR, tunein and so on, and there will be more music platforms involved in the development.

DISCLAIMER: Not all music services are available in all regions and countries.

Line In Mode

The 6000A Play supports wireless broadcasting of any of your music source inputs to other DTS Play-Fi audio solutions on your network. For instance, you can stream the turntable input from your 6000A Play to other DTS Play-Fi wireless speakers or streamers via the app. Perfect for a multi-room home audio solution.

To activate this mode simply click the icon “+” on the top right corner of DTS Play-Fi App, select “Line In”, then select the source unit, source channel and music genre. Finally select the secondary audio output device to which you wish to broadcast and click “Start Line In Broadcast” to play.

Note: there should be at least 2 or more than 2 units of DTS Play-Fi system supporting to use this function. The Broadcast mode can support all the input channels except the Bluetooth functionality.

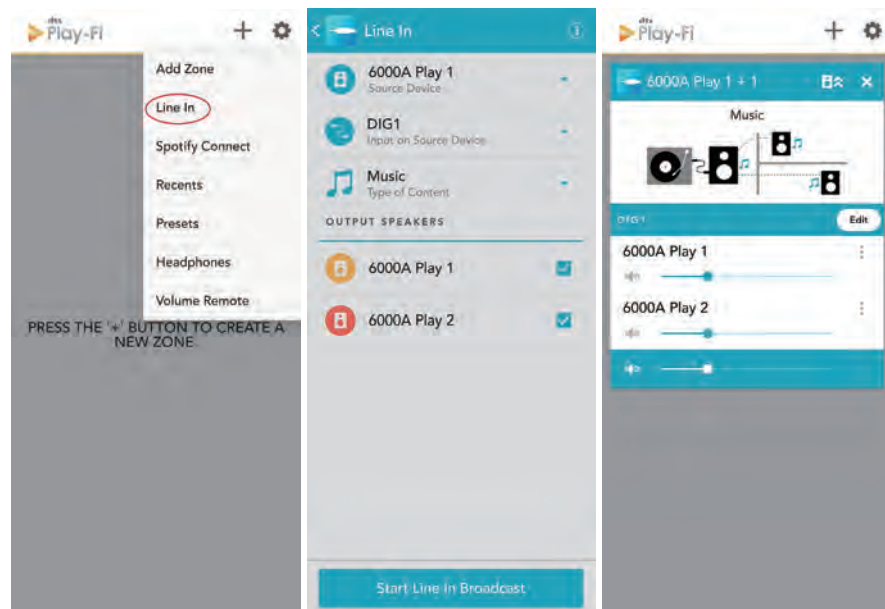

Speakers Group

To stream music from 6000A Play to multi-room Devices such as DTS Play-Fi Speakers, open the DTS Play-Fi APP, find the Device or Speaker, give it a name and then add it.

To delete the Device or Speaker, just click on the right side of the Device name and then delete.

Currently it is not recommended to wirelessly stream Hi-Res audio to speakers if you want stable, uninterrupted playback.

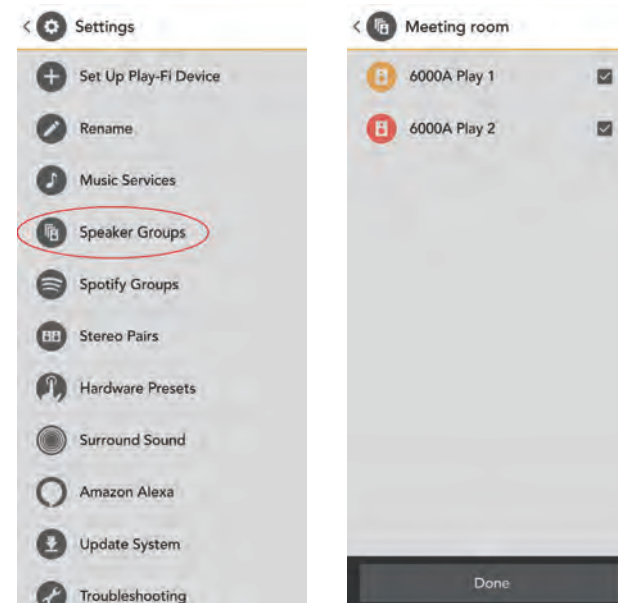

Spotify Group Setup

Open the Set Up of the DTS Play-Fi app and click the Spotify Group. Create a new group and name for it, then select any Play-Fi products you want to add into this group (on the right side). Any speakers that can't be added to the Spotify Group will show in grey. Any speakers that can't be joined to a Spotify Group will be greyed out. Once you're satisfied, head to the Spotify app to start streaming.

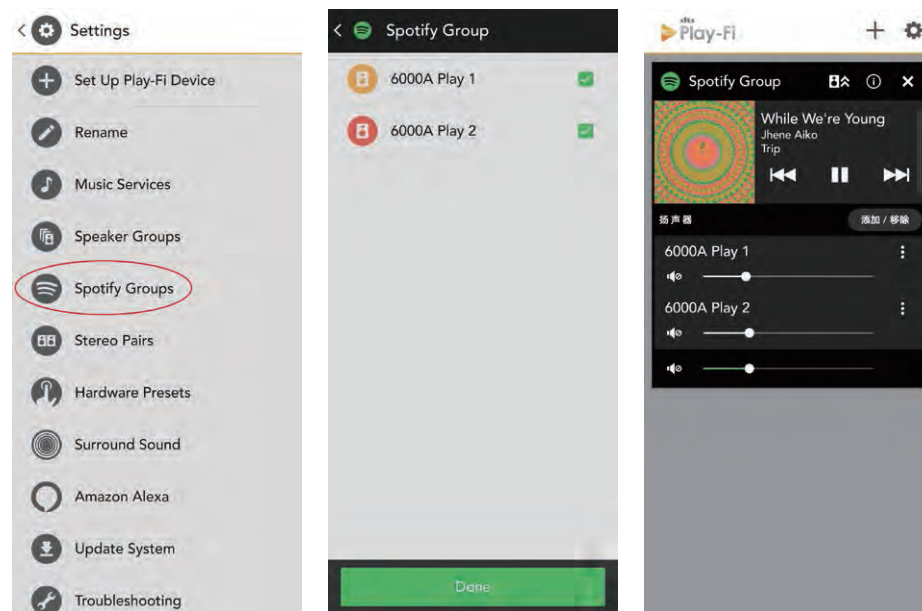

Surround Sound

So far, 6000A Play cannot support Play-Fi Surround. For common problems in utilization and fault diagnosis, you can open the APP settings to find the "Fault diagnosis", then enter the DTS Play-Fi website knowledge base which has the detailed information.

Update System

If there is an update available, click "Update System" and the process will carry on automatically. Click "About", you can see the DTS Play-Fi's APP version and the status of network connection, IP address and versions of the module software and MCU. For 'Advanced Settings' you can choose from various options - the default mode is recommended.

DTS Play-Fi Windows Application

With your PC running Windows 7, 8, 8.1 or 10, the DTS Play-Fi Windows app allows you to stream from any source on your PC (apps, services or Web based) including Spotify, Google Play, iTunes, Xbox Live and more.

Music mode: the free version of the Windows app defaults to Music mode, then select the 6000A Play to play.

Video mode: allows you to sync the audio from any video, whether from a movie file or YouTube, to any one Play-Fi device on your network.

To use Video mode upgrade your app to the Play-Fi HD version. Click the option 'Video mode' then select the device to play.

Play-Fi HD is the only Wi-Fi streaming solution to include advanced codecs and proprietary QoS (Quality of Service) technology. That means audio is delivered with astonishing accuracy, even in the busiest network conditions.

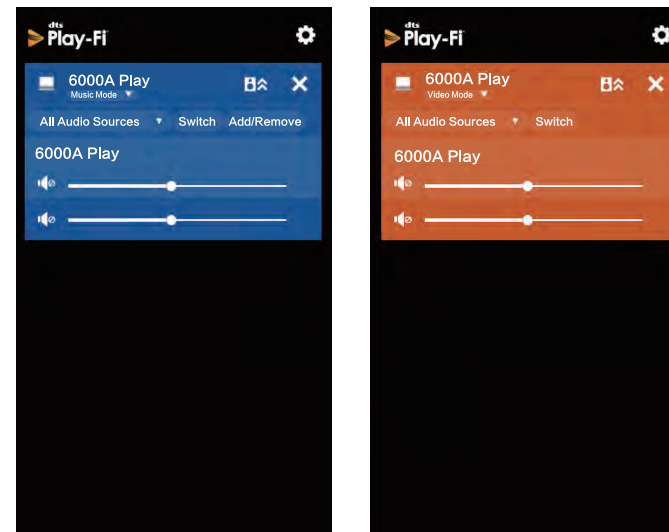

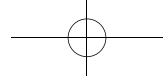

16. Warranty

Audiolab Ltd. warrants this product, subject to the terms and conditions below, to be free from defects in materials and workmanship. During the warranty period Audiolab will repair or replace (at Audiolab's option) this product, or any defective part in this product, if it is found to be defective due to faulty materials, workmanship or function. The warranty period may vary from country to country.

Terms and conditions

The warranty starts on the date of purchase (or the date of delivery if this is later).

You must provide proof of purchase/delivery before work can be carried out. Without this proof, any work carried out will be chargeable to you.

All work will be carried out by Audiolab or its authorized agents or distributors.

Any unauthorized repair or modification will void this warranty.

If any part is no longer available it will be replaced with a functional replacement part.

Any parts that are replaced will become the property of Audiolab.

Any repair or replacement under this warranty will not extend the period of warranty.

This warranty is valid only in the county of purchase, applies only to the first purchaser and is not transferable.

The following are not covered:

1. Products which the serial number have been removed, altered or otherwise made illegible.
2. Normal wear tear and cosmetic damage.
3. Transportation or installation of the product.

Accidental damage, fault caused by commercial use, acts of God, incorrect installation, connection or packing, misuse, neglect or careless operation or handling of the product which is not in accordance with Audiolab's user instructions.

1. Repairs or alterations carried out by parties other than Audiolab or its authorized agents or distributors.
2. Products not purchased from an Audiolab authorized dealer.
3. Products that were not new at the time of original purchase.
4. Products sold 'as is', 'as seen' or 'with all faults'.

Repairs or replacements as provided under this warranty are the exclusive remedy of the consumer. Audiolab shall not be liable for any incidental or consequential damages for breach of any express or implied warranty in this product. Except to the extent prohibited by

law, this warranty is exclusive and in lieu of all other warranties whatsoever, both express and implied, including, but not limited to, the warranty of merchantability and fitness for a practical purpose.

This warranty provides benefits that are additional to and do not affect your statutory rights as a consumer.

Some countries and U.S. states do not allow the exclusion or limitation of incidental or consequential damages or implied warranties so the exclusions in the paragraph above may not apply to you. This warranty gives you specific legal rights, and you may have other statutory rights, which vary from state to state or county to county.

How to claim:

To obtain warranty service contact the Audiolab authorized dealer from which you purchased this product. Do not dispatch goods without the prior agreement of the dealer, Audiolab or their authorized distributors.

We may refer to a local service centre. For international regions, please contact:

IAG House, 13/14 Glebe Road, Huntingdon, Cambridgeshire, PE29 7DL, UK.

Tel: +44 (0) 1480 452561 Eml: service@audiolab.co.uk

If asked to return products for inspection and/or repair, pack carefully, preferably in the original cartons or packing affording an equal degree of protection, and return prepaid. If unsuitable packaging is used, Audiolab may make a charge for the supply of new packaging.

Insurance is recommended and goods are returned at owner's risk. Audiolab or their authorized distributors cannot be held liable for loss or damage in transit.

17. Specifications

Model	6000A Play
	IEEE 802.11a/b/g/n/ac
	Supports global, popular streaming content (Amazon Music, Spotify, TIDAL, KKBox, SiriusXM, Napster, Internet Radio, Deezer, iHeartRadio, Pandora, SoundMachine, Qobuz, QQmusic)
DTS Play-Fi® Technology	Supports Speaker Groups
	Supports Android/iOS/Kindle Fire/Windows PC Control
Analogue inputs	3 x AUX , 1x Phono (MM), 1x Power In
Digital Input	2 x Coaxial, 2 x Toslink Optical, Bluetooth (aptX/aptX LL)
Analogue output	1x RCA Pre Out
Pre-amplifier Section	
Gain	+8dB (Line) +55dB (Phono MM)
Input Sensitivity	720mV (Line, Volume = 0dB) 3.1mV (Phono MM, Volume=0dB)
Input Impedance	10K (Line) 47K//100pF (Phono MM)
Total Harmonic Distortion (THD)	< 0.0004% (1KHz @ 2V, Volume = 0dB)
Frequency Response	20Hz-20kHz (+/-0.1dB)
Output Voltage	2.3V max. (Volume=0dB)
Output Impedance	120 ohm
Signal-to-Noise Ration (S/N)	> 110dB (Line, A-weighted) > 76dB (Phono MM, A-weighted)
DAC	
D to A converter	ES9018K2M
Total Harmonic Distortion (THD)	< 0.0006% (1KHz @ 0dBFS)
Output level (0dBFS, 1KHz)	2.05V
Max. Sampling Frequency	192KHz
Signal-to-noise ratio (S/N)	> 112dB (A-weighted)
Digital Filtes	Fast Roll-off , Slow Roll-off , Minimum Phase

Power Amplifier Section	
Gain	+29dB
Rated Max. Power Output	2 X 50W (8 ohm, THD<1%) 2 X 75W (4 ohm, THD<1%)
Frequency Response	20Hz-20kHz (+/-0.3dB)
Input Sensitivity	720mV (Volume=0dB)
Total Harmonic Distortion (THD)	< 0.003% (1kHz @ 40W/8ohm)
Signal-to-Noise ratio (S/N)	> 110dB (A-weighted)
Max. Output Current	9A

Headphone Amplifier	
Total Harmonic Distortion (THD)	< 0.01% (1kHz, 10mW into 20ohm)
Output Impedance	2.35 ohm
Load impedance	20-600 ohm

General	
Standby Power Consumption	< 0.5W
Power Requirements	220-240V ~ 50 - 60H z (depending on region) 100-120V ~ 50 - 60H z
Dimensions (mm) (W x H x D)	445 x 65.5 x 300
Carton Size (mm) (W x H x D)	512 x 467 x 155
Weight	7.9kg (Net) 10kg (Gross)
Finish	Black/Silver

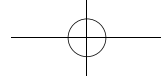

Correct disposal of this product. This marking indicates that this product should not be disposed with other household wastes throughout the EU. To prevent possible harm to the environment or human health from uncontrolled waste disposal, recycle it responsibly to promote the sustainable reuse of material resources. To return your used device, please use the return and collection systems or contact the retailer where the product was purchased. They can take this product for environmental safe recycling.

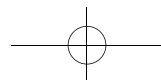
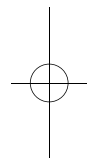
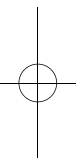
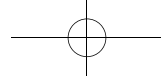

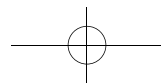
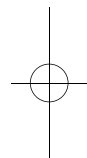
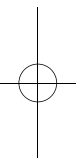
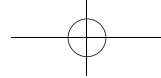

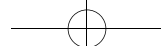

Audiolab
IAG House,
13/14 Glebe Road,
Huntingdon,
Cambridgeshire,
PE29 7DL,
UK
Tel: +44(0)1480 452561
Email: service@audiolab.co.uk
<http://www.audiolab.co.uk>

