



PHOENIXM2
User Manual

DO NOT RETURN THIS PRODUCT TO THE STORE

Please contact a DEFENDER® customer support representative first regarding any additional information on product features, specifications or assistance with setup. Please contact us via one of the methods below:

Contact us form: www.DefenderCameras.com/support

WARRANTY INFORMATION

We take quality very seriously. This is why all of our products come with a one-year warranty from the original purchase date against defects in workmanship and materials. If you have a warranty or support issue, please contact us at www.DefenderCameras.com/support

For more information about your product's warranty, please visit our website at www.DefenderCameras.com

WARRANTY TERMS

1. DEFENDER® products are guaranteed for a period of one year from the date of purchase against defects in workmanship and materials. This warranty is limited to the repair, replacement or refund of the purchase price at DEFENDER®'s discretion.
2. This warranty becomes void if the product shows evidence of having been misused, mishandled or tampered with contrary to the applicable instruction manual.
3. Routine cleaning, normal cosmetic and mechanical wear and tear are not covered under the terms of this warranty.
4. The warranty expressly provided for herein is the sole warranty provided in connection with the product itself and no other warranty, expressed or implied is provided. DEFENDER® assumes no responsibilities for any other claims not specifically mentioned in this warranty.
5. This warranty does not cover shipping costs, insurance, or any other incidental charges.
6. You MUST contact DEFENDER® before sending any product back for repair. You will be issued a Return Authorization number with return instructions. When returning the product for warranty service, please pack it carefully in the original box with all supplied accessories, and enclose your original receipt or copy, and a brief explanation of the problem (include RA #).
7. This warranty is valid only in Canada and the continental U.S.
8. This warranty cannot be re-issued.



THANK YOU

You've made a fine choice to protect what you value most.

FCC

This Device Complies with part 15 of the FCC Rules

Operation is subject to the following two conditions: (1) this device may not cause harmful interference, and (2) this device must accept any interference received, including interference that may cause undesired operation

FCC note: the manufacturer is not responsible for any radio or tv interference caused by unauthorized modifications to the equipment. Such modification could void the user's authority to operate the equipment.

IC note: low power device rf

Operation is subject to the following two conditions: (1) this device may not cause harmful interference, and (2) this device must accept any interference received, including interference that may cause undesired operation.

CLASS B OR A PRODUCTION: This class (B) digital apparatus complies with Canadian ICES-003.

DISCLAIMER

DEFENDER® does not endorse any of DEFENDER® products for any illegal activities. DEFENDER® is not responsible or liable in any way shape or form for any damage, vandalism, theft or any other action that may occur while a DEFENDER® product is in use by the consumer.

TABLE OF CONTENTS

IMPORTANT! PLEASE READ

DO NOT RETURN THIS PRODUCT TO THE STORE	2
WARRANTY INFORMATION	2
WARRANTY TERMS	2
THANK YOU	3
FCC	3
DISCLAIMER.....	3

ABOUT YOUR PRODUCT

FEATURES	5
WHAT'S INCLUDED	5
BUTTONS AND CONNECTIONS.....	6
MONITOR	6
CAMERA	7

INSTRUCTION

THINGS TO KNOW BEFORE YOU BEGIN!.....	8
INITIAL SET UP	8
MONITOR	8
CAMERA(S).....	8
INSTALLING CAMERAS.....	9
RECORD	10
SETTING DURATION FOR MOTION RECORD.....	10
ACCESSING THE RECORD SCHEDULE	11
UNDERSTANDING THE SCHEDULE SCREEN	12
SETTING UP SCHEDULE RECORD	13
SETTING EACH CAMERA(S) FOR SCHEDULE RECORDING.....	14
SETTING SENSITIVITY FOR MOTION DETECTION	15
SETTING MOTION RECORD	15
SETTING FILE OVERWRITE	16
CAMERA OPTIONS	17
PAIRING CAMERAS	17
TURNING CAMERAS ON/OFF	19
ADJUSTING CAMERA BRIGHTNESS	20
CHANGING THE CAMERA RESOLUTION.....	22
MONITOR SETTINGS.....	24
SETTING THE DATE AND TIME	24
RETURNING TO DEFAULT SETTINGS	25
FORMATTING MEMORY.....	27
CHANGING THE TIME ZONE	28
DAYLIGHT SAVINGS.....	29
FIRMWARE UPDATE.....	31
SETTING ALERT	33
PLAYBACK RECORDED FILES	34
DELETING INDIVIDUAL RECORDED FILES.....	35

TROUBLESHOOTING

NO PICTURE/SIGNAL	36
NO AUDIO	36
DEVICES ARE NOT PAIRING	36
NIGHT VISION NOT WORKING	36
MONITOR IS READING NO SIGNAL	36
FOOTAGE NOT RECORDING.....	36

SPECIFICATIONS

MONITOR.....	37
CAMERA	37

FEATURES

Digital Wireless Technology: Superior digital frequency with a wireless range up to 150 feet (optimal range) that ensures clear video and audio. The convenience of a digital wireless signal also allows you to set your system up in just a matter of minutes.

SD Card Recording: Record up to 700 minutes of video and audio directly onto the included 8GB SD card. Choose to record constantly, based on a set schedule or only when motion is detected.

Long Range Night Vision: Sixteen infrared (IR) LEDs let you see in the dark, up to 40ft away!¹ The LEDs automatically activate when it gets dark, giving you around the clock protection.

Weather Resistant Camera: The camera is built with durable aluminum, weather resistant housing² so you can use it outdoors in almost any weather condition. You can use it indoors for monitoring your business, inventory or home.

Expandable up to 4 Cameras: This system can support up to four cameras so you can monitor multiple offices, entrances and outdoor areas at the same time.

Motion Detection Settings: Motion detection gives you the option to record only when movement is detected to conserve your SD card memory. Your system will start recording and alert you when motion is detected. This system offers both a PIR Sensor recording and pixel change detection.

IR Cut Filter: The IR Cut filter will block light sources that could be misinterpreted as infrared (such as UV light) resulting in more realistic color and clearer image during the day.

24 Hour Scheduled Recording: Personalize a 24 hour recording schedule. Record video footage using two different types of recording modes: manual and scheduled.

7" LCD Monitor: View your live or recorded footage easily on the 7" LCD monitor. Its functional design allows it to be wall mounted or placed on a table.

Lifetime Customer Support: Our customer support team can be reached on our website at www.defender-usa.com/contact. Our experts will be happy to assist you in English, French and Spanish.

WHAT'S INCLUDED

1. Monitor
2. Camera(s)
3. Power cord(s)
4. Mounting hardware
5. Pairing Tool
6. Antennas for the camera
7. SD card³

Disclaimer

1. IR illumination range up to 40ft under ideal conditions. Objects at or beyond this range may be partially or completely obscured, depending on the camera application.
2. Not for use in direct exposure to water, rain or snow. Although the cameras are water resistant they are not waterproof.
3. This unit can support an SD card up to 256GB. Please note when 'expanding' up to 256GB SD card the SD will need to be re-formatted.

BUTTONS AND CONNECTIONS

Monitor

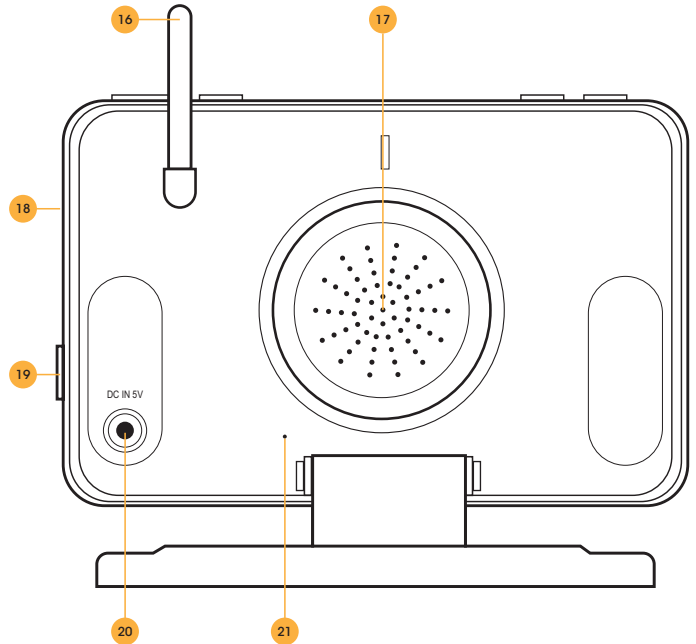
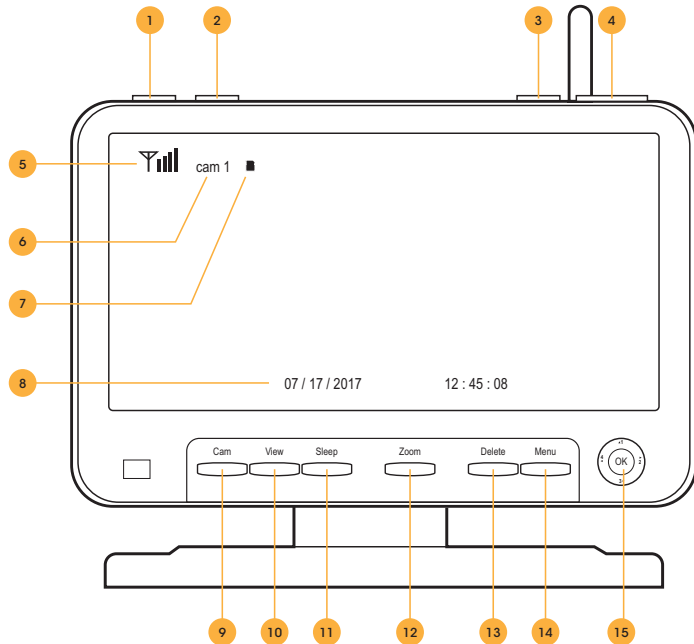

1. **Motion Record:** Prompts the monitor to record only when motion is detected. To stop motion recording, press this button again.
2. **Rec:** Manual Record will prompt the monitor to begin constant recording. To stop recording, press this button again.
3. **Power:** Press and hold this button to turn the monitor on and off.
4. **Volume:** This adjusts the volume of the audio that plays through your monitor.
5. **Signal strength:** Tells you how good the reception is from the camera to the monitor.
6. **Camera:** Tells you which camera is being shown in live viewing mode.
7. **File:** If the file symbol is visible it means you have recorded footage stored. If the icon is red, this means the card is full.
8. **Date:** Displays current date and time.
9. **Cam:** Changes from one camera to another.
10. **View:** Allows you to change the cameras viewing from single, split screen or quad view.
11. **Sleep:** When pressed allows the monitor screen to turn off until motion is detected in front of the camera(s). Once motion is detected in front of the camera the monitor will turn back on.
12. **Zoom:** While in live view mode, pressing zoom will allow 1X zoom on the picture. Pressing zoom again will zoom back out.
13. **Delete:** During playback this button allows you to delete single clips of recorded footage.
14. **Menu/Exit:** Enters and exits the Main Menu.
15. **Joystick:** Allows movement to navigate through the menu. Pressing the joystick in will allow you to select the menu option. In Live view press the joystick in to enter the Recording File List Menu.
16. **Antenna:** Raising the antenna allows for a stronger signal between the camera and monitor.
17. **Speaker:** Allows you to hear sound from your camera.
18. **SD Card Insert:** The SD card will be inserted into this area to record and save footage.
19. **Talk:** Allows for two-way communication, pressing this button allows you to speak through the monitor to the camera.
20. **Power Input:** Plug the small end of the included power adapter marked monitor into this area, and the other end to a power outlet.
21. **Reset:** Using a paper clip press and hold the reset button to restore factory settings.

Camera

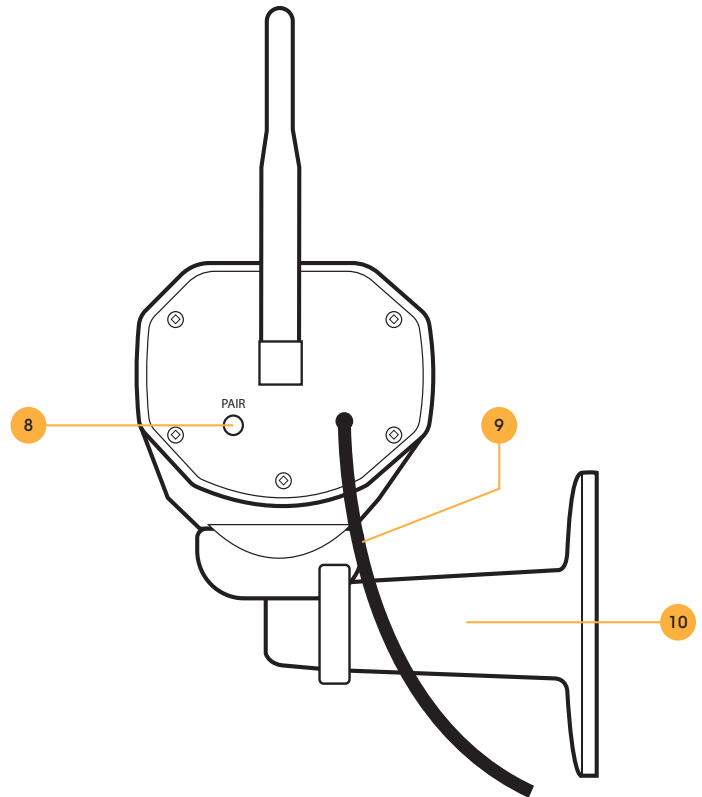
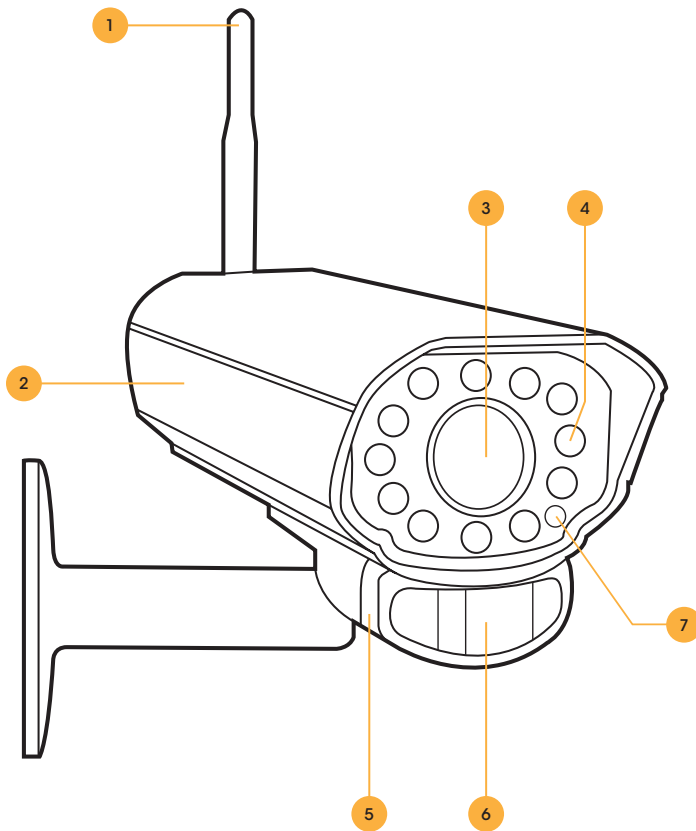

1. **Antenna:** This removable antenna allows for a better signal between the camera and monitor.
2. **Camera Housing:** Made of anodized aluminum to prevent rust.
3. **Camera Lens:** The camera lens is located in the center of the LEDs.
4. **Infrared (IR):** The 16 LEDs allow the camera to see in the dark up to 40ft away.
5. **Speaker/Microphone:** Allows you to hear and record sounds, and talk back to whomever you are recording.
6. **Motion Detection Sensor:** Detects any motion in front of the camera up to 12ft.
7. **CDS Sensor:** Automatically turns on the infrared LEDs when it gets dark.

8. **Pair Button:** Located at the back of the camera. Press this button when pairing the camera and monitor. For more information, please see Pairing on page 18.
9. **Power Connection:** This 6 ft. cord connects to the power adapter (marked Camera).
10. **Camera Mount:** Allows the camera to be wall mounted or placed on a table. (Camera image cannot be rotated when viewing)

NOTE:

This camera includes an Auto Mechanical IR Cut Filter. When the camera changes between day mode and night vision mode, an audible clicking noise may be heard coming from the camera. This clicking is normal, and indicates that the camera filter is working

THINGS TO KNOW BEFORE YOU BEGIN!

1. The camera should be installed between 8 to 13ft above the area to be monitored.
2. For best results install the camera NO MORE than 100ft away from the monitor's position to maintain a strong signal between the camera and monitor.
3. Before mounting the camera, ensure there are no obstructions in the camera's view.
4. Place the camera in the most strategic place where it can provide the most detailed video of your home or business. Having the camera in the open for people to see can help deter criminals.
5. To cover large, dark areas such as backyards, garages, and driveways, place camera in a strategic location, such as on the roof or deck. This way, more area is covered by the camera.
6. Ensure that the camera is positioned to avoid glare. Be sure to position camera away from direct sunlight or indoor lighting.
7. For best results, light in front of the camera should be around the same brightness as the light around the area or object being monitored.
8. Decide whether the camera will be wall-mounted, or mounted on a desk/table top. We recommend that the mount is secured using the included screws and hardware for all installations.

INITIAL SET UP

Monitor

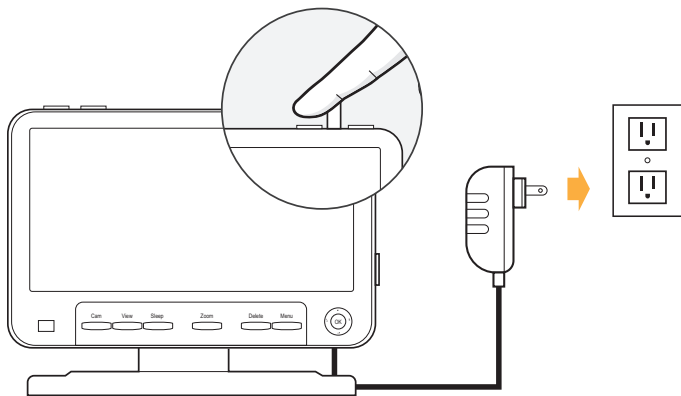

- Plug in the power cord labeled for the monitor into the DC port on back of the monitor
- Plug the other side of the power cord into a power outlet
- Press and hold the power button on the top right of the monitor to turn the unit on.

Camera(s)

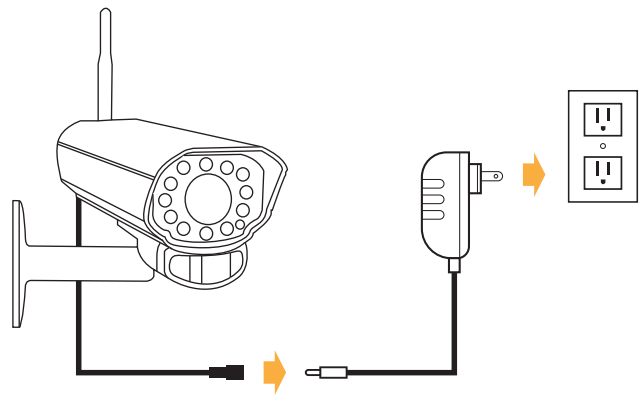

- Plug the cord labeled for Camera into the camera
- Plug the other side of the power cord into a power outlet
- Attach the antenna
- Pair cameras if not paired upon powering the camera

INSTALLING CAMERAS

1. Decide if the camera will be wall-mounted or sitting on a desk/tabletop. The camera can be adjusted for many mounting scenarios by rotating it to the required position.
 - Keep in mind that the camera is microphone equipped. If you would like to record audio, make sure the camera is within a close enough range to record sound (within 6 ft).
 - For best results be sure to mount the camera no further than 150ft away from your monitor in direct line of sight without interference.
 - Be sure to mount the camera no further than 8ft away from a power source.
2. Screw the mounting bracket into the camera's mounting hole, turning it clockwise.
3. Ensure that the camera is strongly secured into the wall.
4. Adjust the camera to the desired viewing angle.
5. Once you have mounted the camera and placed it at the desired viewing angle, plug the camera's power adapter (marked for camera) into the cord on the camera and then plug the adapter into a power source (a surge protected power source is recommended).
6. If you purchased a kit with additional cameras, ensure that the cameras are paired and repeat the above steps for all additional cameras.

NOTE:

The camera view cannot be rotated when viewing. Please ensure the camera is angled properly.

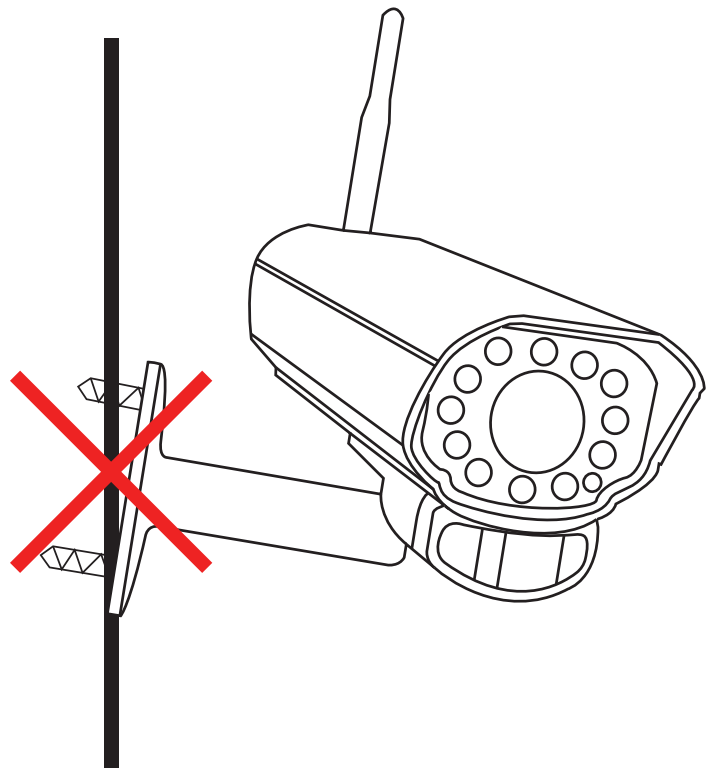
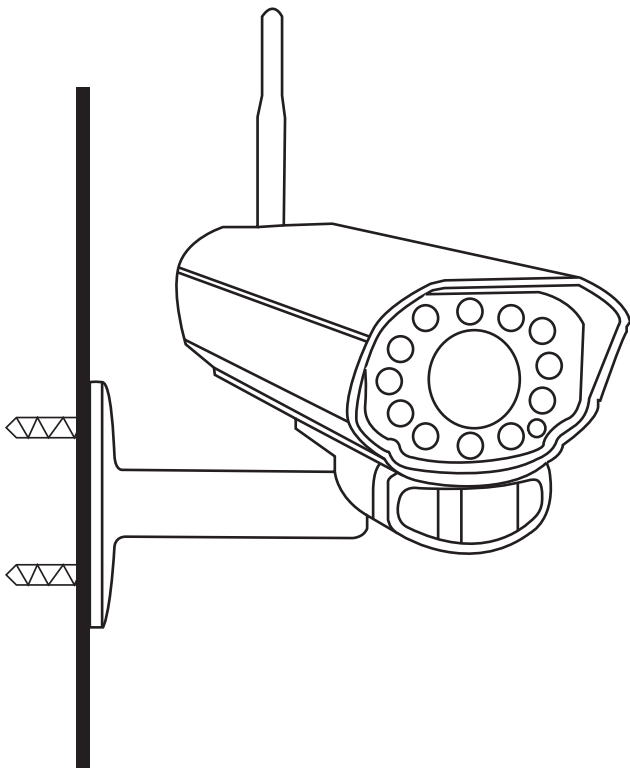

RECORD

Setting Duration for Motion Record

Allows you to set the length of time the unit will record once motion is no longer being detected.

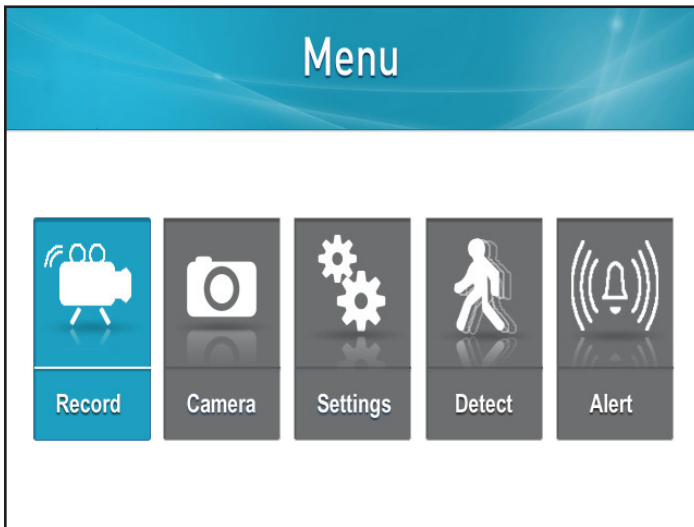

1. Press the Menu button

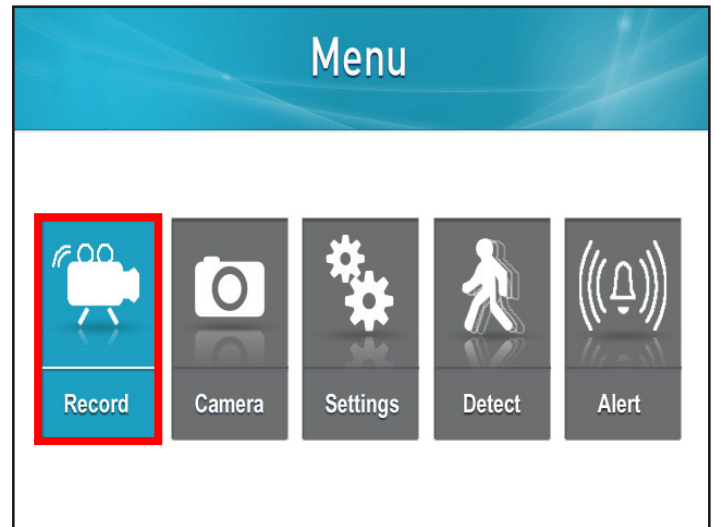

2. Select Record

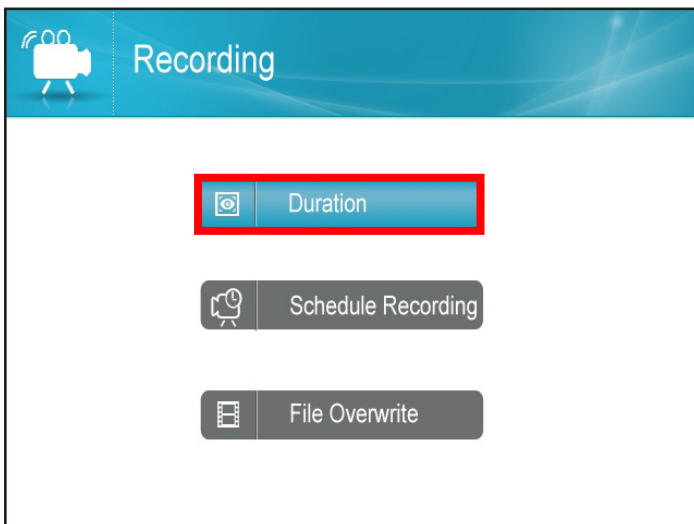

3. Select Duration

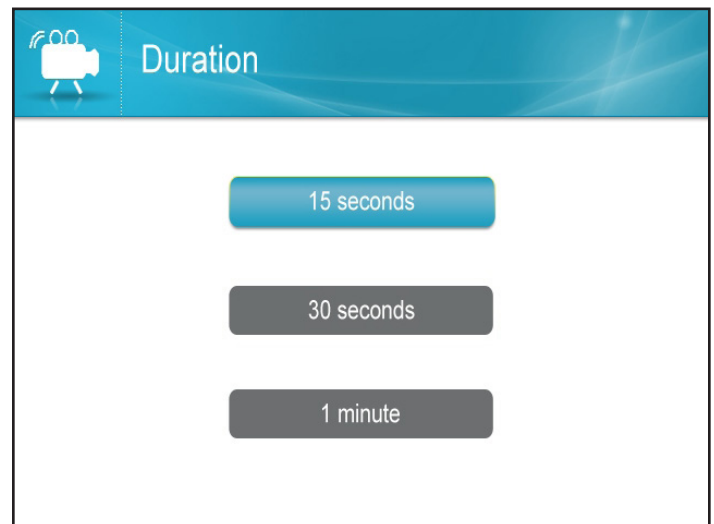

4. Select the desired time for post-motion recording

Accessing the Record Schedule

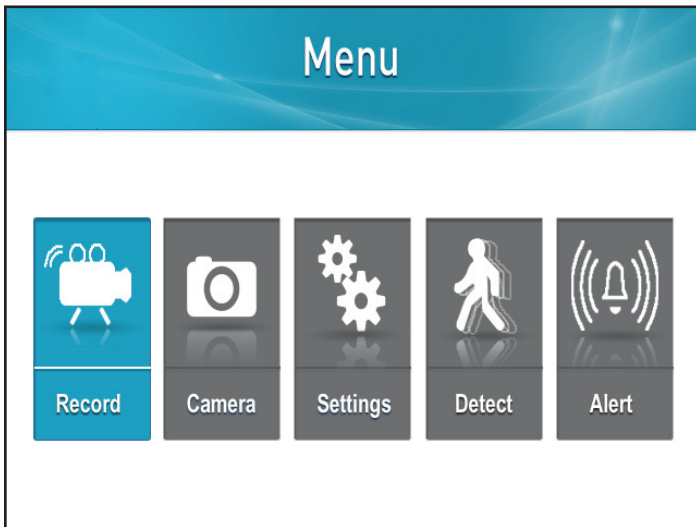

1. Press the Menu button

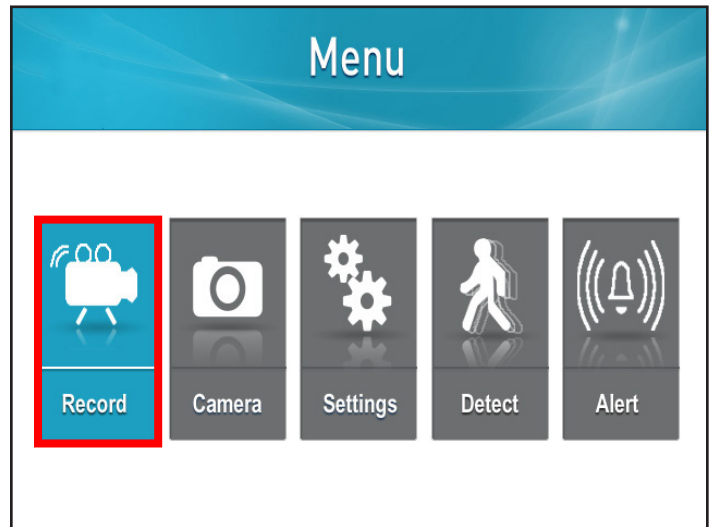

2. Select Record

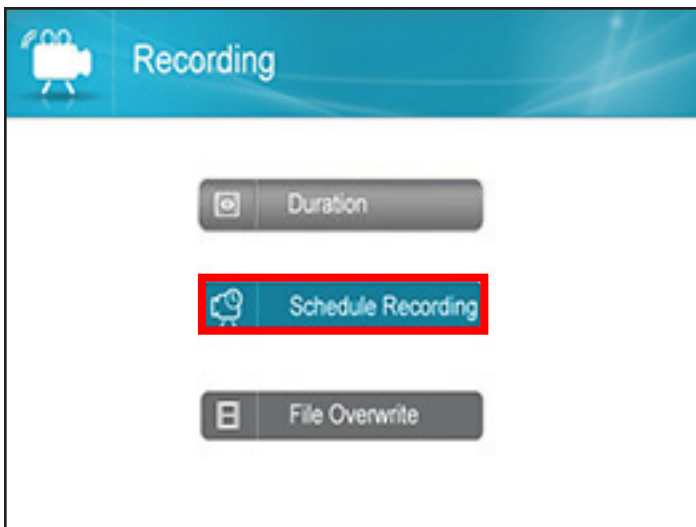

3. Select Schedule Recording

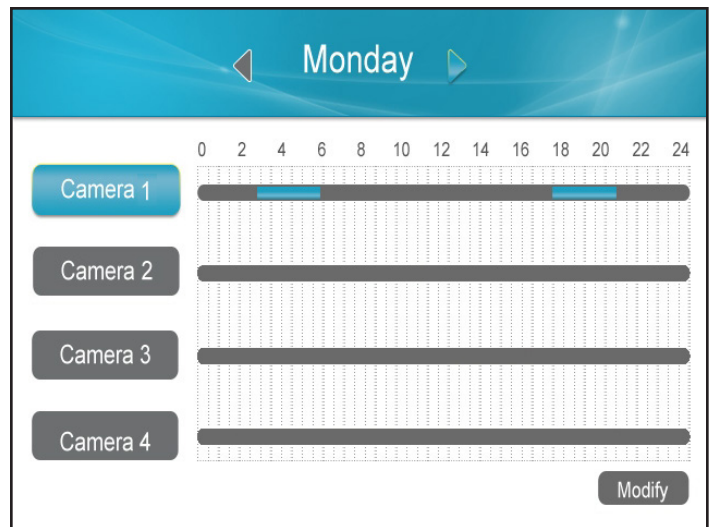

4. This screen will be shown

Understanding the Schedule Screen

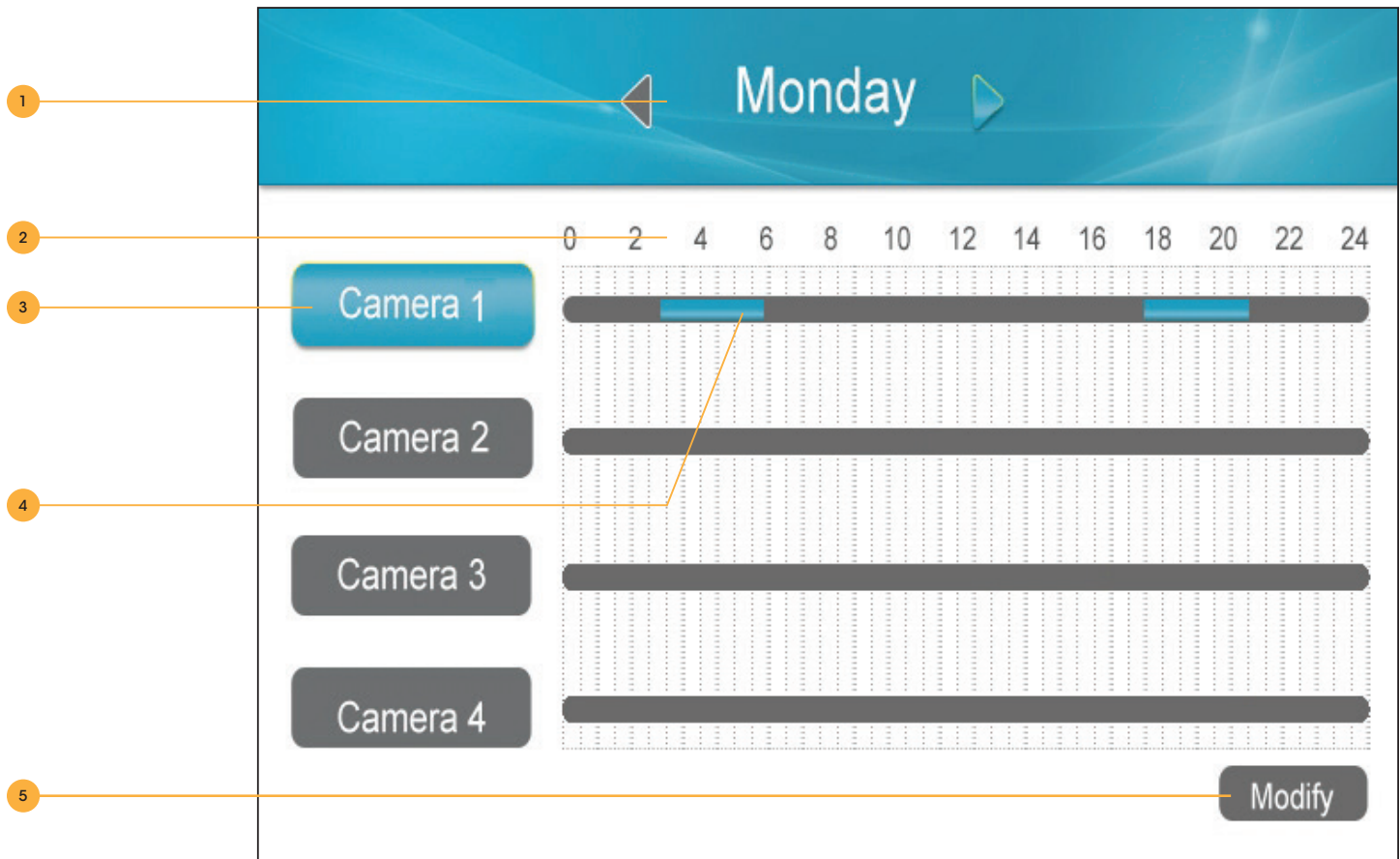

1. **Day of the week:** Use the LEFT or RIGHT navigation arrow keys on the joystick to change the day at the top. Corresponding record schedule for that day will appear below.
2. **Time:** The record schedule uses a 24 hour clock.
3. **Camera:** Each camera can have a different record schedule.
4. **Record schedule:**
 - Grey - No recording has been set for that time
 - Blue - Continuous record has been set for that time. (If a full 24 hour period has been selected from midnight to midnight, the line stays grey)
5. **Modify:** Allows you to change the Record Schedule.

Setting up Schedule Record

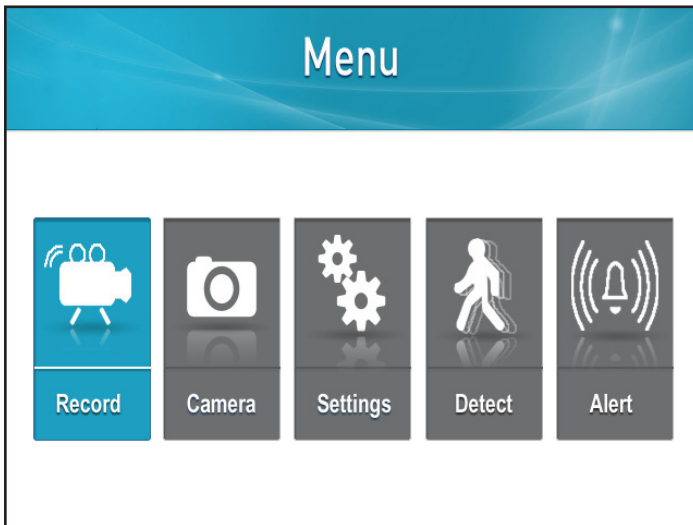

1. Press the Menu button

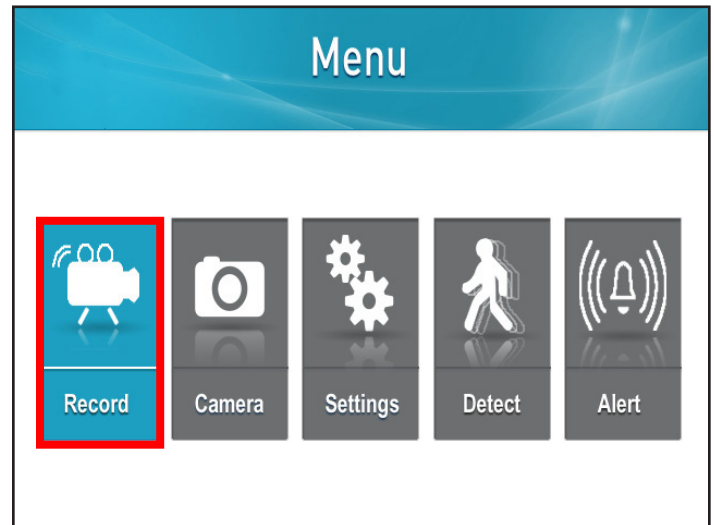

2. Select Record

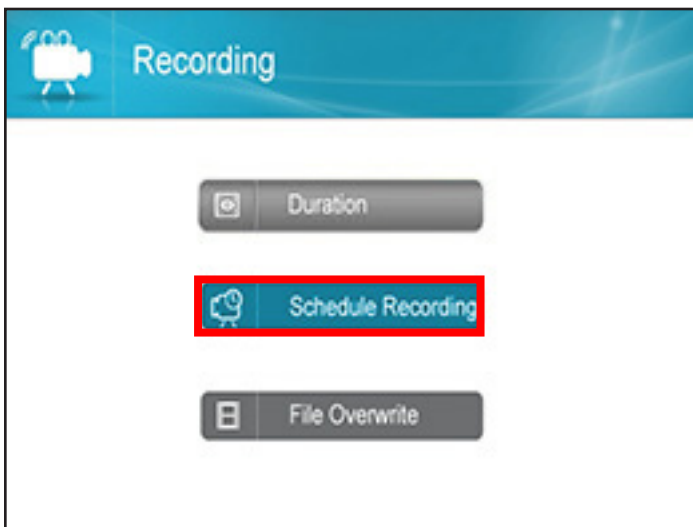

3. Select Schedule Recording

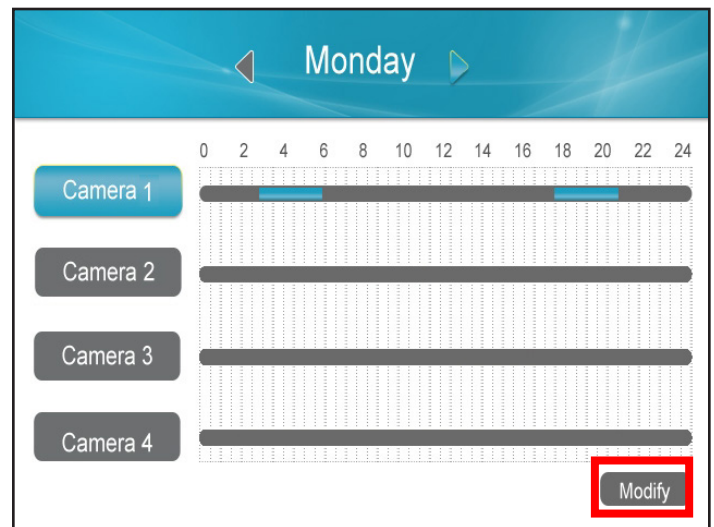

4. Press Joystick when Modify is highlighted

SETTING EACH CAMERA(S) FOR SCHEDULE RECORDING

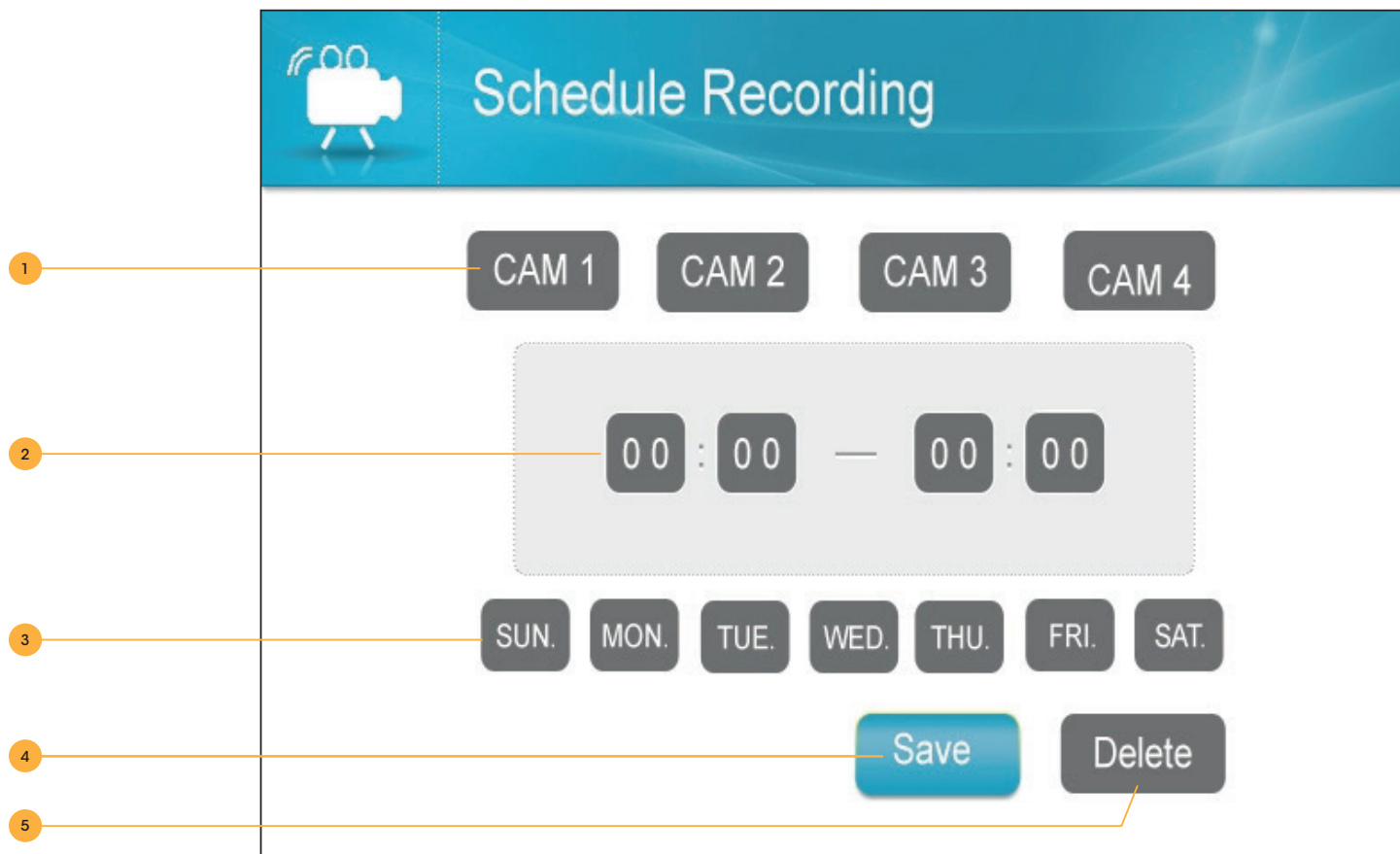

1. **Camera:** To select the camera you would like to set up a Record Schedule for, use RIGHT or LEFT navigation arrows to move the Green box over the desired camera(s). Select OK to select each camera you wish to set a Record Schedule for. When selected, the box will turn Blue.
2. **Setting the Time:** Use the navigation arrows until the Green box is around the time you would like to change. Use UP or DOWN navigation arrows to change the time. When complete use the RIGHT navigation arrows to move to the next time box.
3. **Days of the Week:** To select the days of the week you would like to set the Record Schedule for, use the navigation arrows to move the Green box over desired day(s). Press OK to select each desired day.
4. **Save:** Will save the schedule you have set up.
5. **Delete:** Will delete the current schedule.

NOTE:

All that are highlighted will have the same schedule.

Setting Motion Record

To enable Motion Recording, select the Motion button on the top of the screen. You will now see a Red moving man icon . The camera will now start recording when motion is detected.

NOTE:

If Scheduled Recording is set up and motion is enabled, the unit will record based on the Scheduled Recording by default.

Setting Sensitivity for Motion Detection

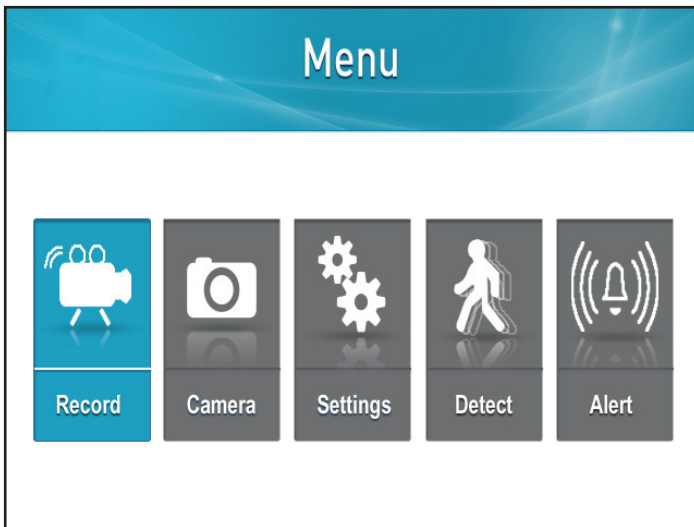

1. Press the Menu button

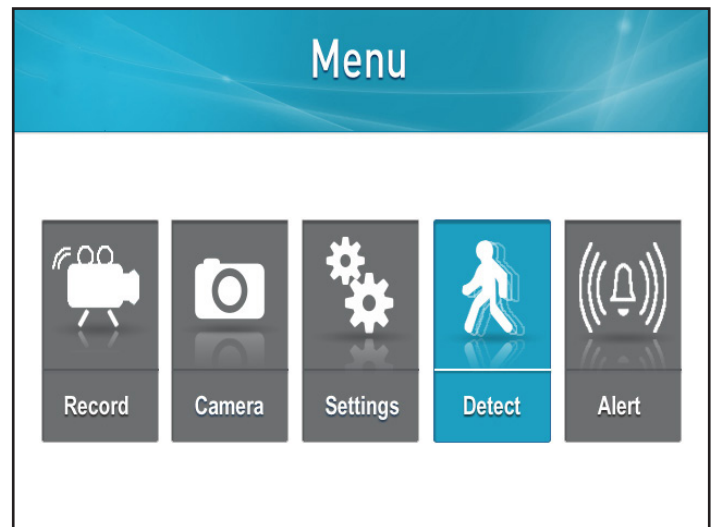

2. Select Detect



3. Select the camera(s) you would like to set the sensitivity level for. Using the UP or DOWN navigation arrows, highlight the camera you would like to adjust

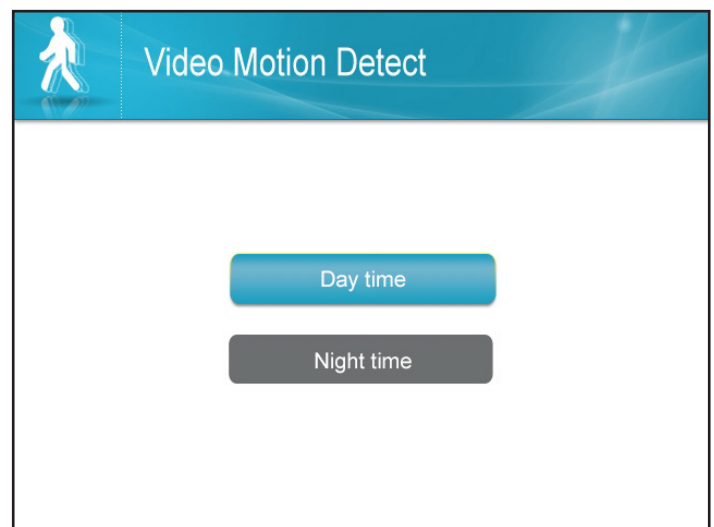

4. Select the time of day you would like to set the sensitivity level for



5. Select the desired sensitivity level

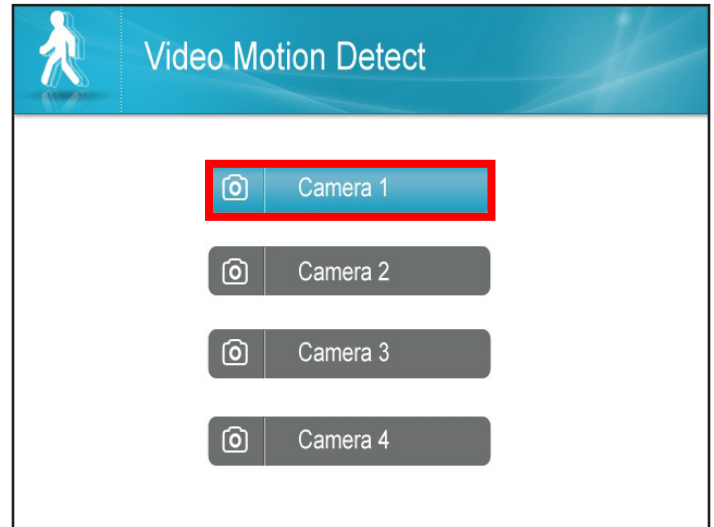

6. Select OK and you will return to the Video Motion Detect page

NOTE:

The higher the sensitivity level the farther the motion will be detected. The lower the sensitivity, the closer the monitor will pick up

Setting File Overwrite

This gives the monitor permission to start overwriting previously recorded files when the memory card is full.

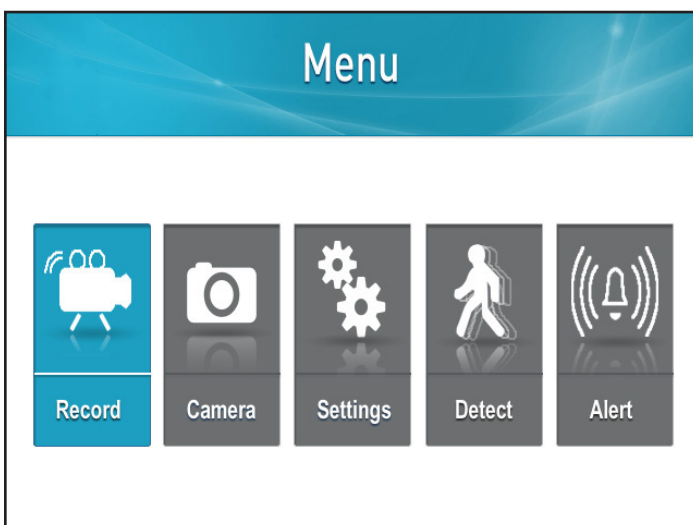

1. Press the Menu button

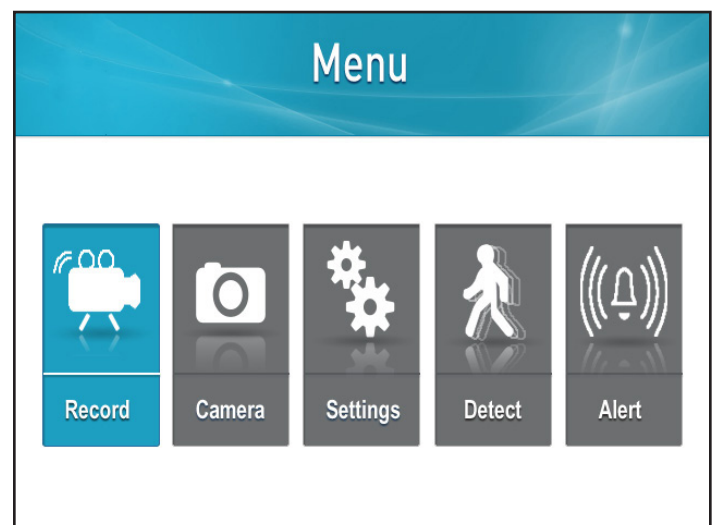

2. Select Record

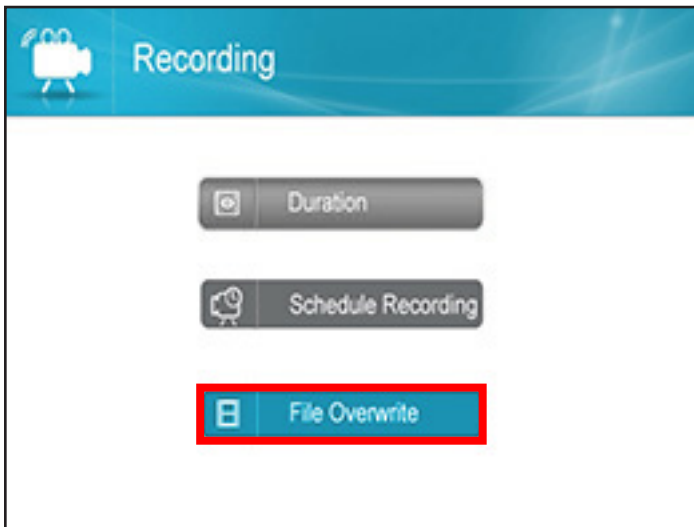

3. Select File Overwrite



4. Select Yes to confirm the overwrite or No, to return to the Record Menu

NOTE:

If File Overwrite is not enabled and the SD card becomes full, recording will stop.

CAMERA OPTIONS

Pairing Cameras

Connecting the camera and monitor will allow the camera live feed screen and recorded to the SD card. If you have purchased an additional camera it is necessary to follow the pairing process.

*If camera does not come paired or if you would like to add additional cameras, complete the following steps:

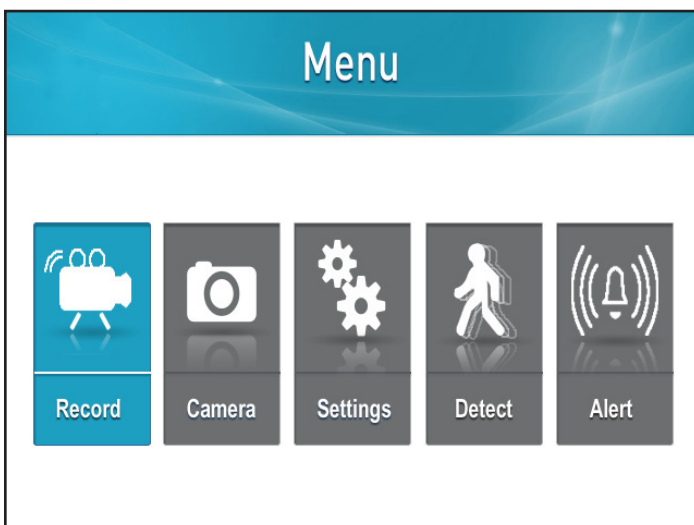

1. Press the Menu button

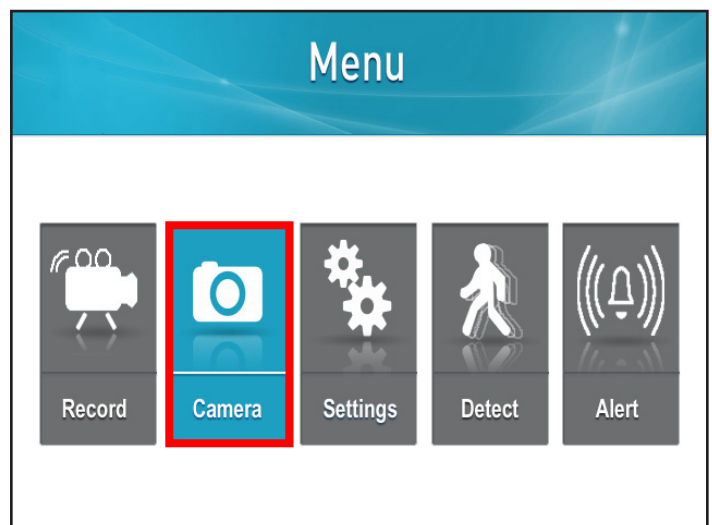

2. Select Camera

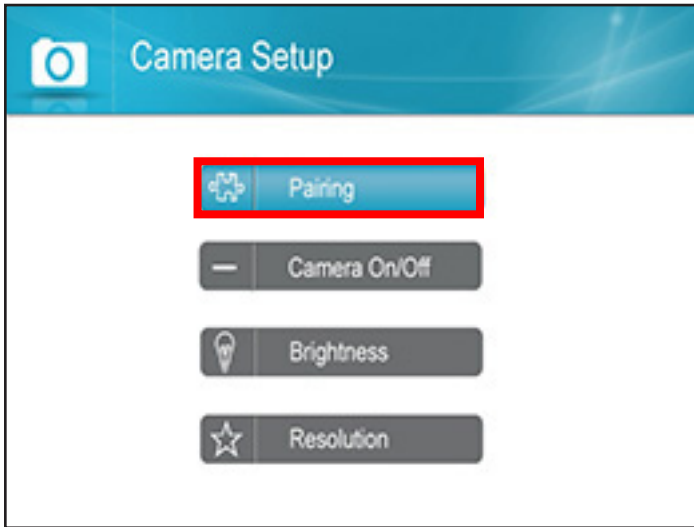

3. Select Pairing



4. Select which camera you would like to pair and the pair screen will appear with a 30 second count down

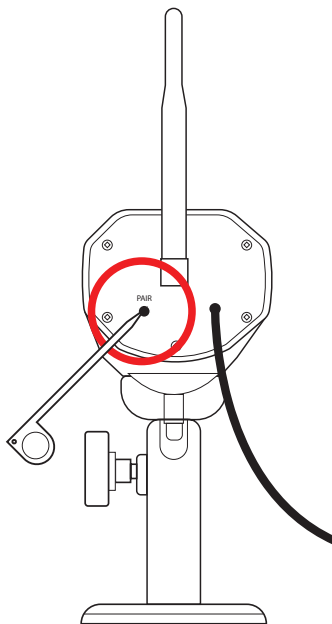

5. Using the thin white pairing tool, push the pairing button on the back of camera before time runs out

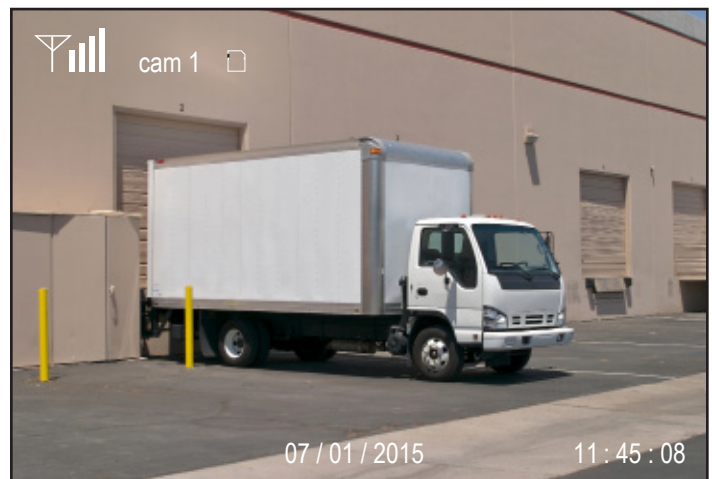

6. When pairing is successful the video will return to the screen

Turning Cameras On/Off

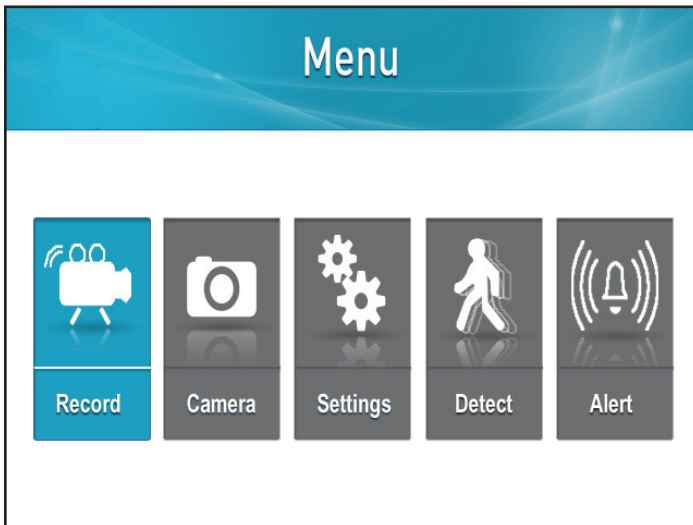

1. Press the Menu button

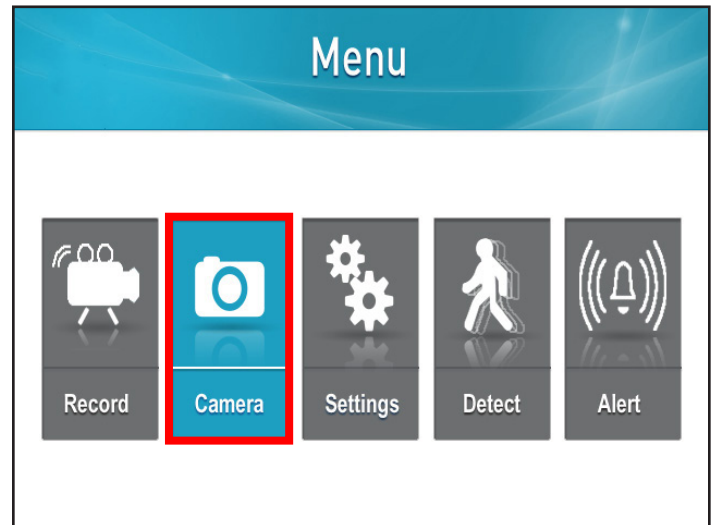

2. Select Camera



3. Highlight which camera you would like to turn On or Off



4. When the desired camera is highlighted Blue: Press the LEFT navigation arrow to turn Off or the RIGHT navigation arrow to turn On



5. Select OK to confirm the selection



6. You will see a Please Wait message. When complete you will return to the Camera Setup page

Adjusting Camera Brightness

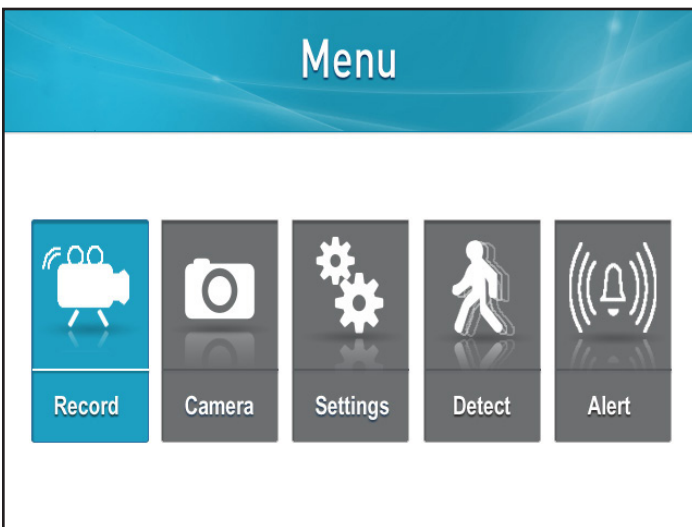

1. Press the Menu button

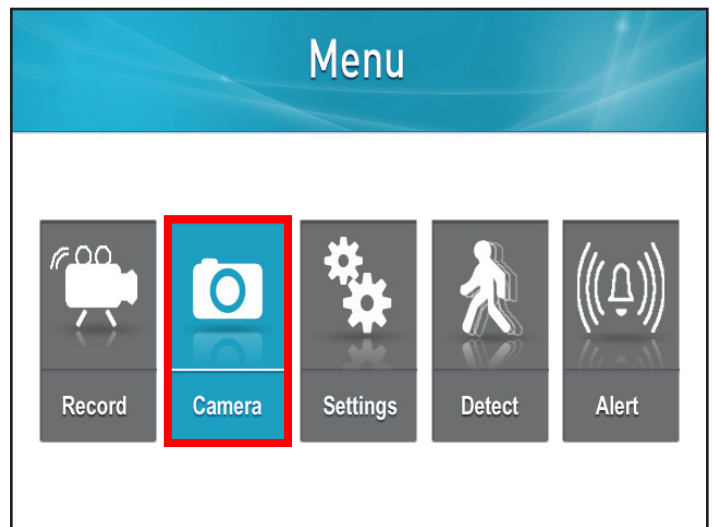

2. Select Camera

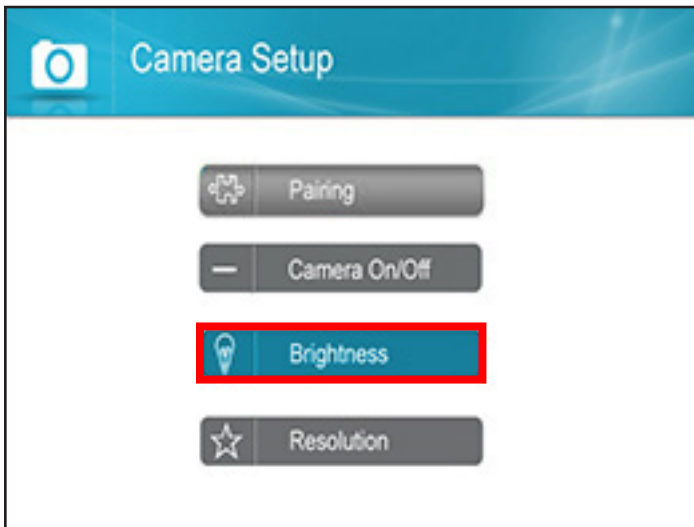

3. Select Brightness

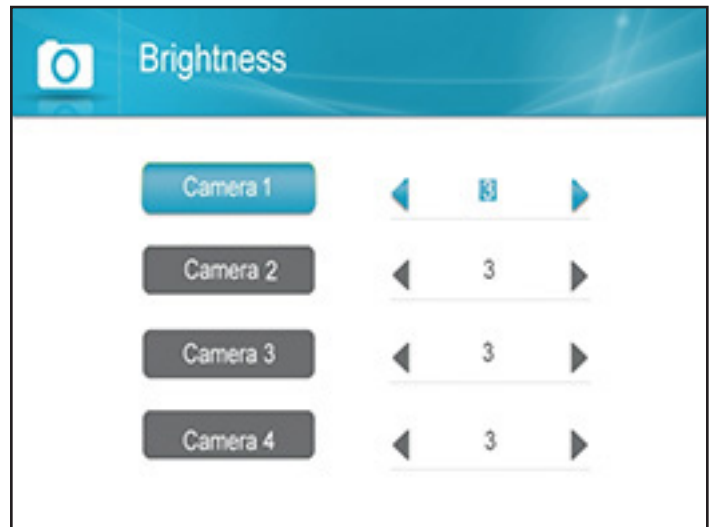

4. Using the LEFT or RIGHT navigation arrows, highlight the camera you would like to adjust and change the Brightness

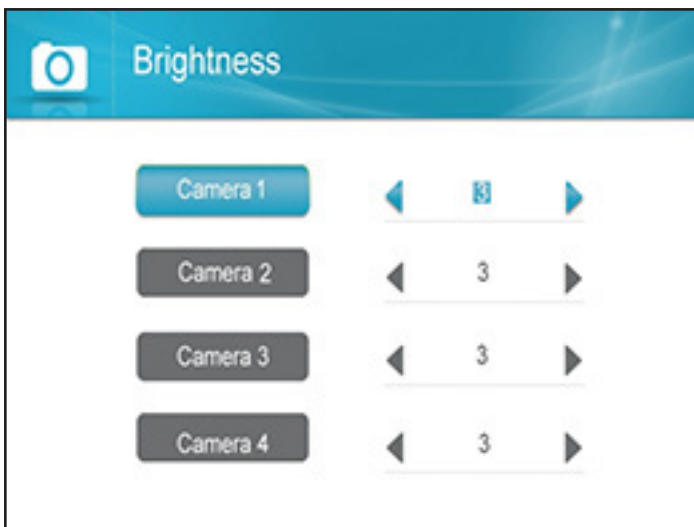

5. When the desired camera is highlighted in Blue press the RIGHT or LEFT navigation arrows until you reach the desired brightness level (1 low - 6 High)



6. Press OK to save the settings and you will return to the Camera Settings page

Changing the Camera Resolution

The Frames Per Second can vary depending on the number of cameras paired with the unit. Please see the chart after the steps to understand the frames per second ratio and the changes to the frames per second when connecting more than one camera.

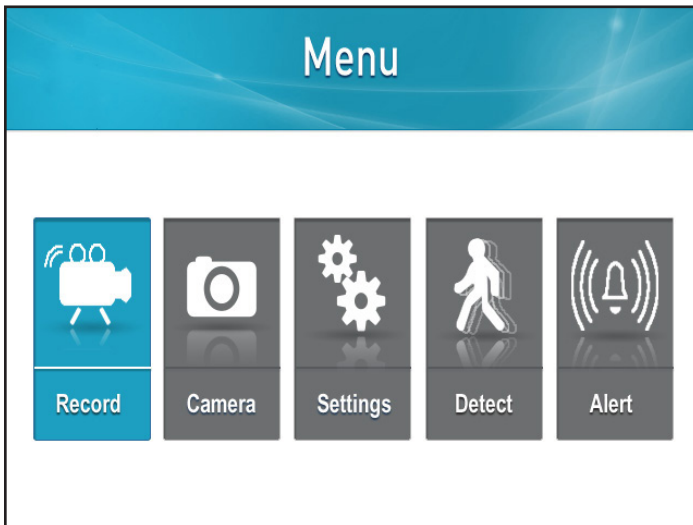

1. Press the Menu button

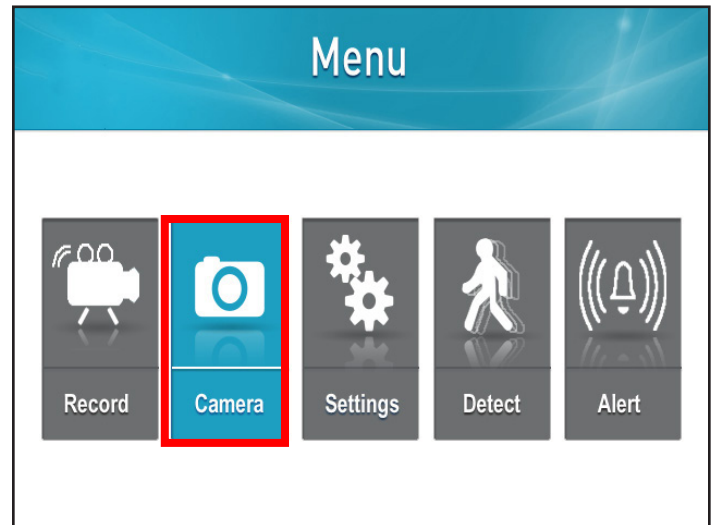

2. Select Camera

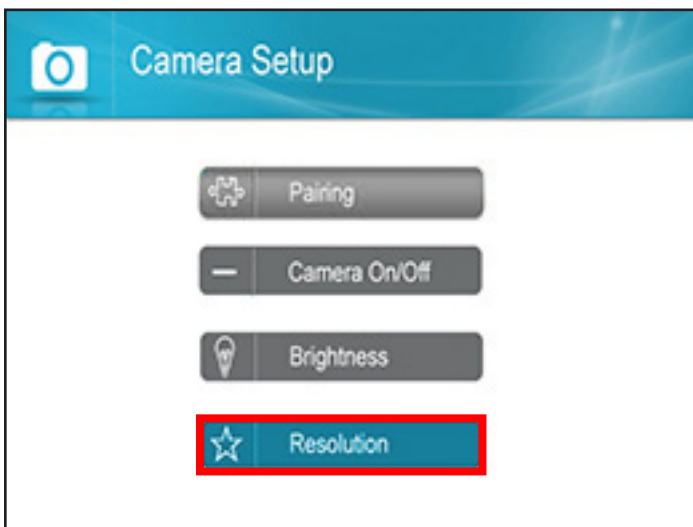

3. Select Resolution



4. Highlight which camera you would like to change resolution for by using UP or DOWN navigation arrows



5. When the desired camera is highlighted in Blue, use the LEFT or RIGHT navigation arrows to change the Resolution

6. Press OK to save the settings and you will return to the Camera Setup Page

Frames per second ratio:

Number of Cameras	QVGA	VGA
1 Camera	N/A	30 fps
2 Camera	30 fps	15 fps
3 Camera	30 fps	7.5 fps
4 Camera	30 fps	7.5 fps

QVGA (Quarter Video Graphics Array) is a small-screen display mode in which the resolution is 320 pixels horizontally by 240 pixels vertically (320 X 240)

VGA (Video Graphics Array) is a high resolution standard for displaying text, graphics, and colours that has a resolution of 640 X 480 pixels.

MONITOR SETTINGS

Setting the Date and Time

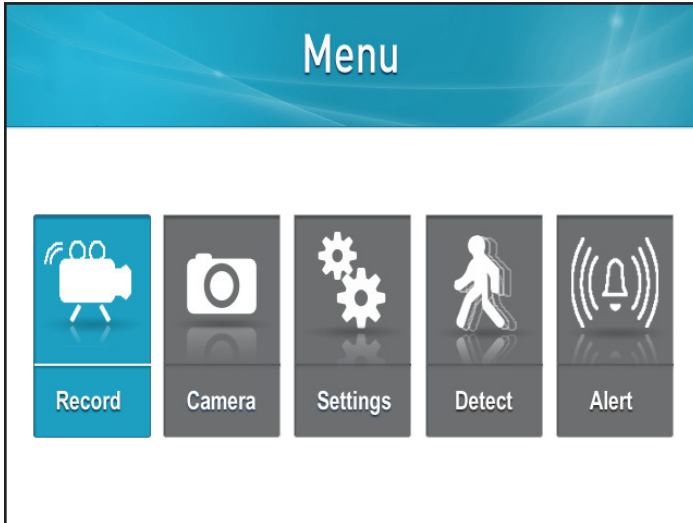

1. Press the Menu button

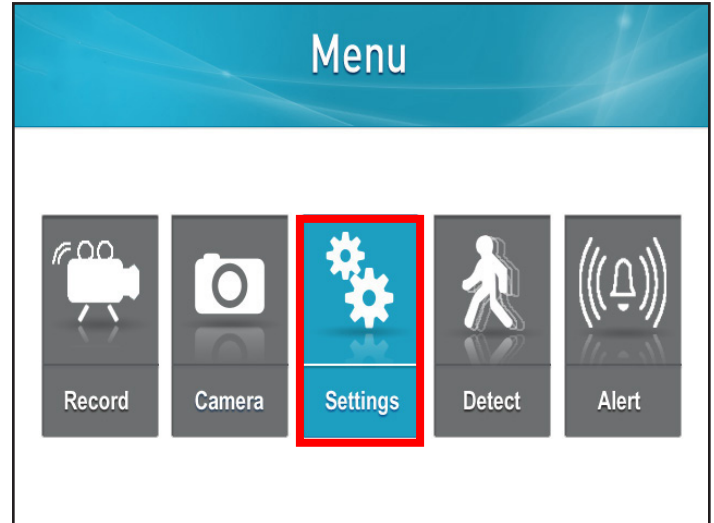

2. Select Settings

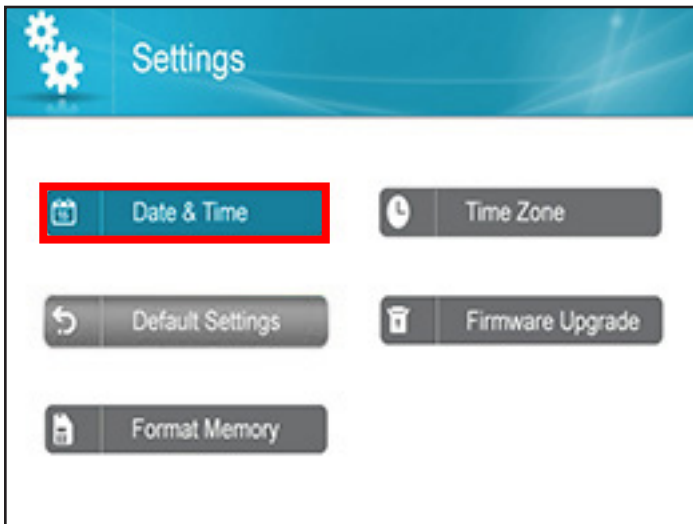

3. Select Date and Time

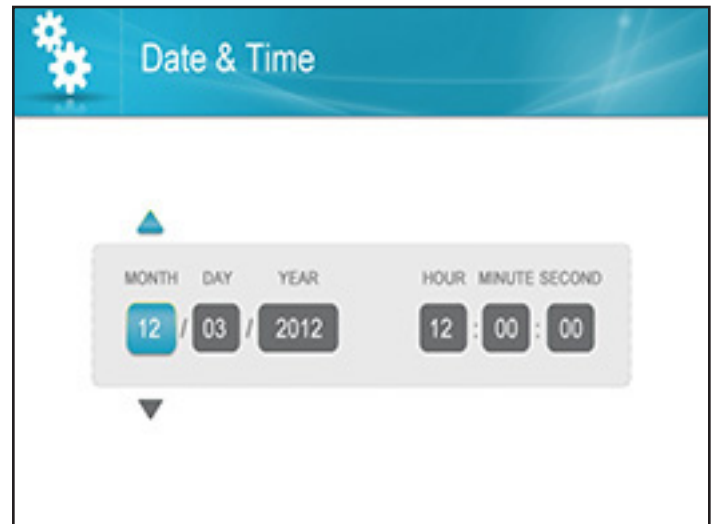

4. Use the LEFT or RIGHT navigation arrows to highlight the box you would like to change (Example: Month, Day, Year, Hour, Minute, Second)

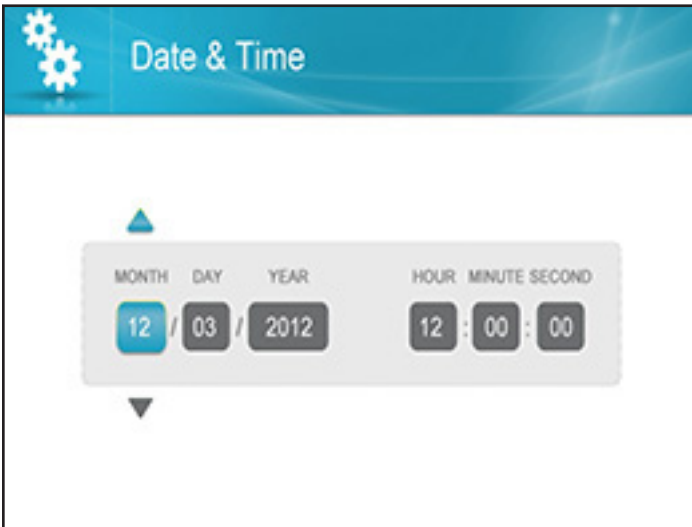

- When highlighted, use the UP or DOWN navigation arrows to make changes

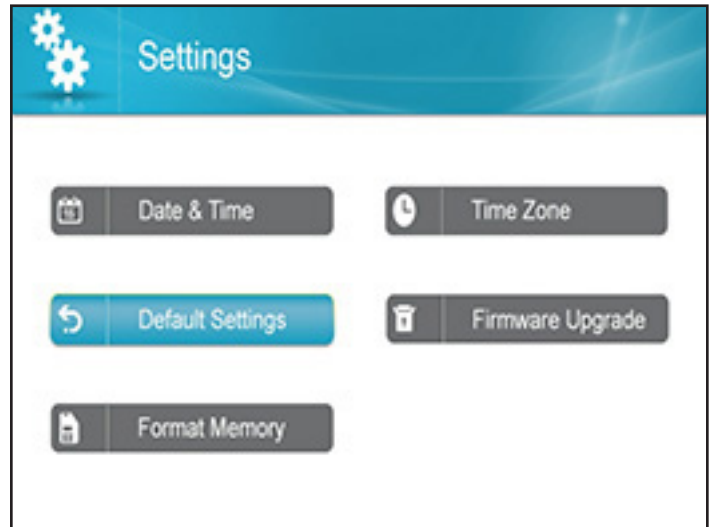

- Press OK to save the setting and you will return to the Settings page

Returning to Default Settings

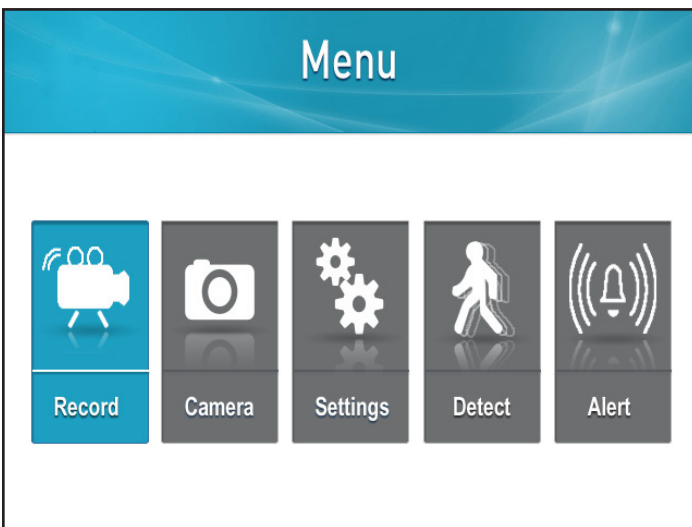

- Press the Menu button

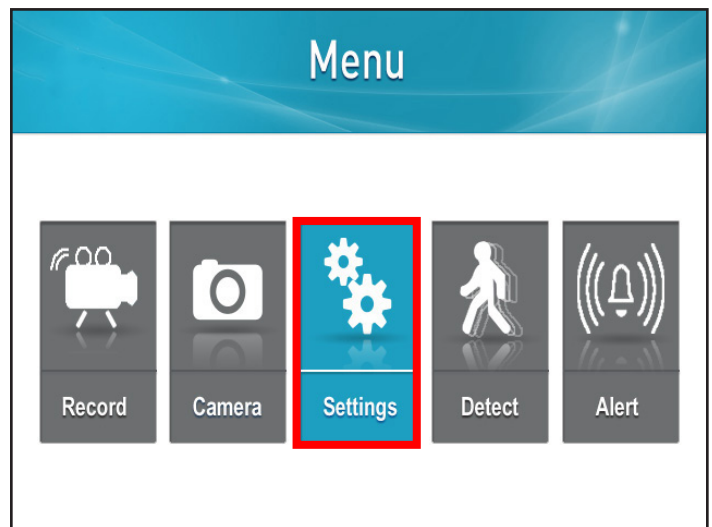

- Select Settings

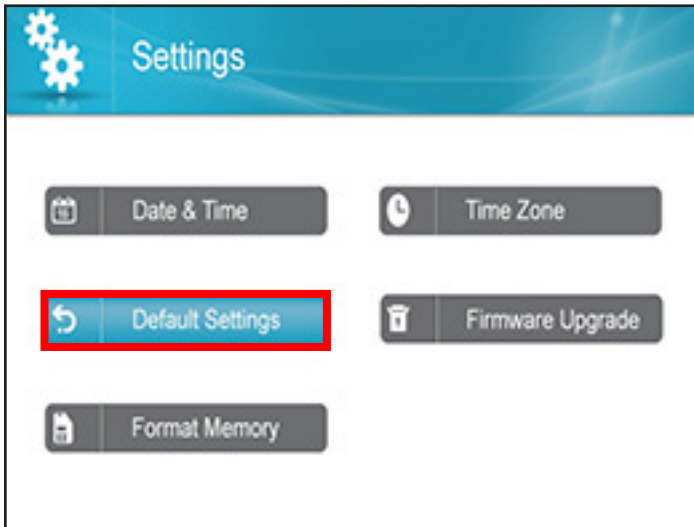

3. Select Default Settings, press OK



4. Select Yes if you wish to set Default Settings or No to return to the Settings page

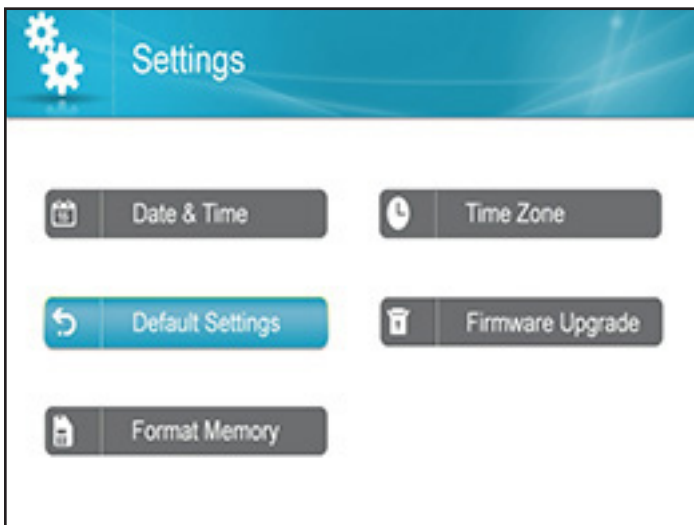

5. If Yes is selected you will see a "Restore Default Settings" message. Select Yes to confirm. Once complete you will return to the Settings page

NOTE:

This will change the monitor back to the default settings. It will not delete footage from the SD card

Formatting Memory

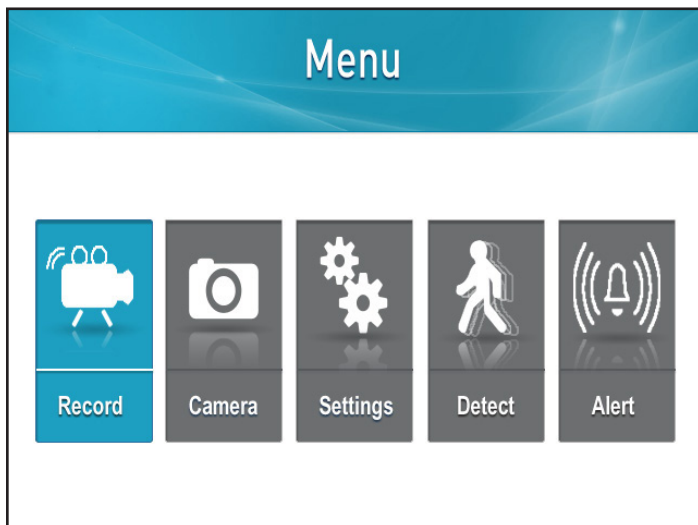

1. Press the Menu button

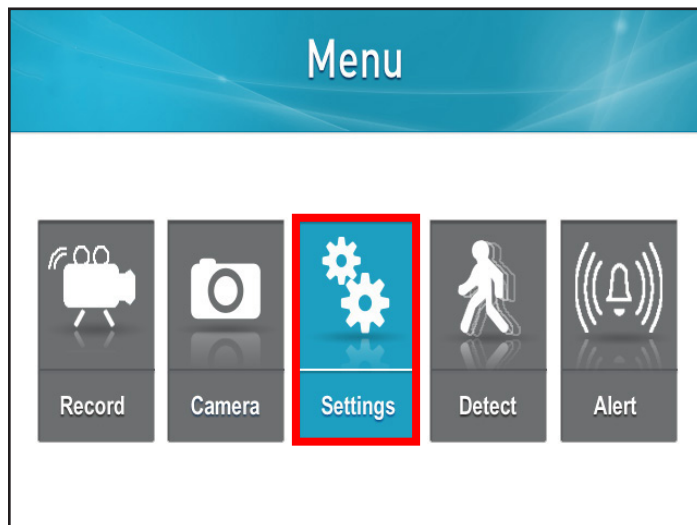

2. Select Settings

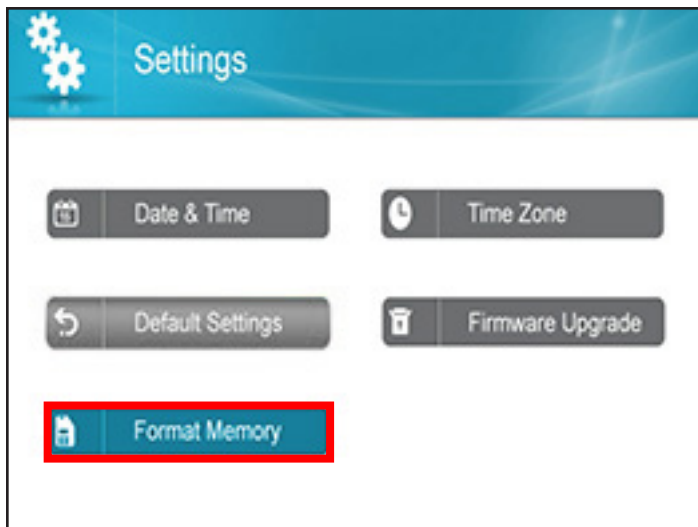

3. Select Format Memory

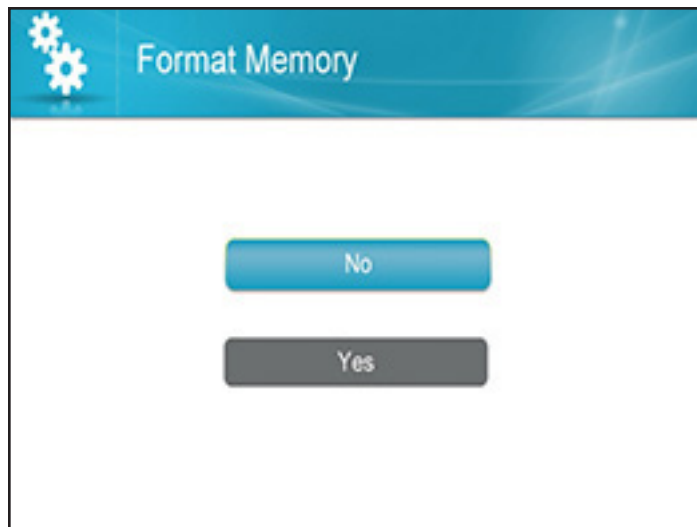

4. Selecting No will return to the Settings page

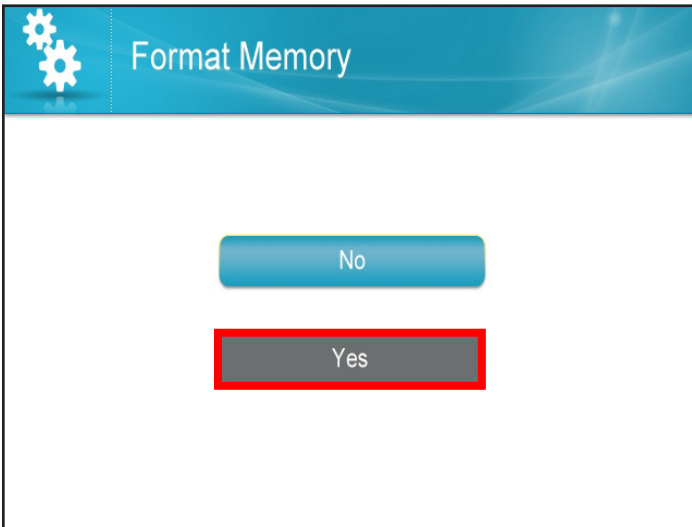

NOTE:
 Formatting the memory will delete the recorded footage from the SD Card, it will not change the settings

- If you Select Yes, "Formatting Please Wait" will appear. The screen will return to the Settings page

Changing the Time Zone

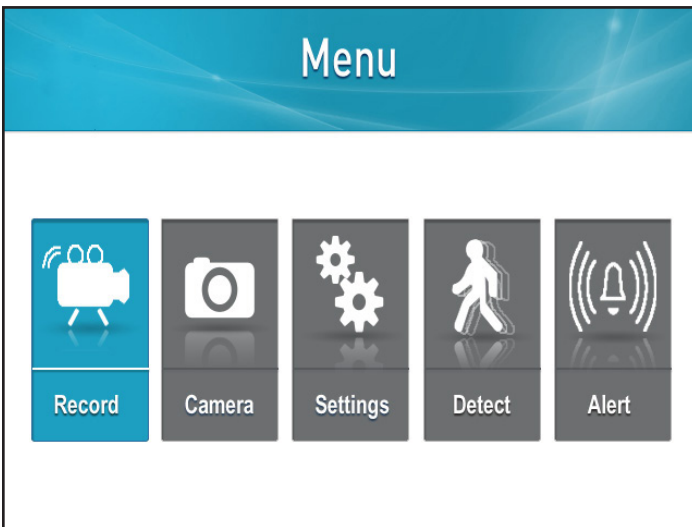

- Press the Menu button

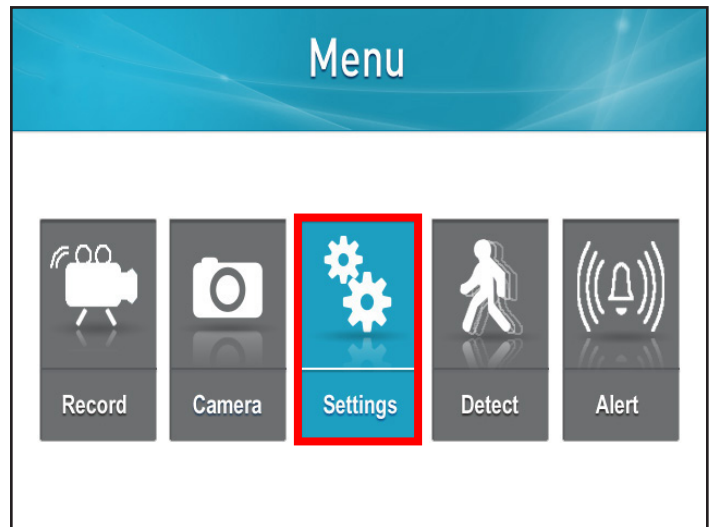

- Select Settings

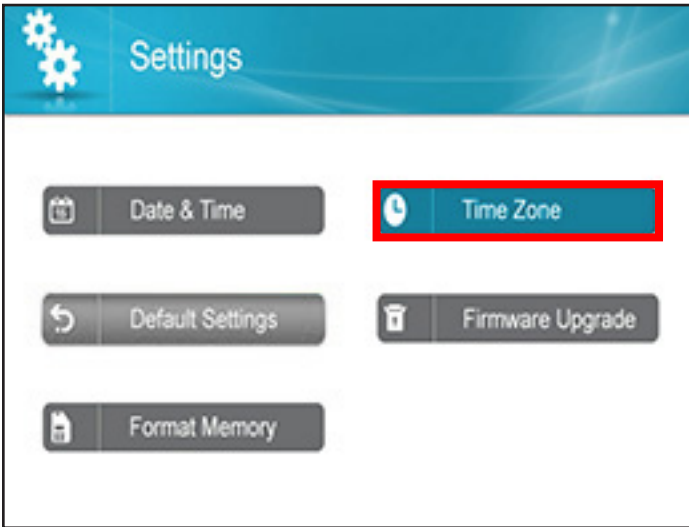

3. Select Time Zone

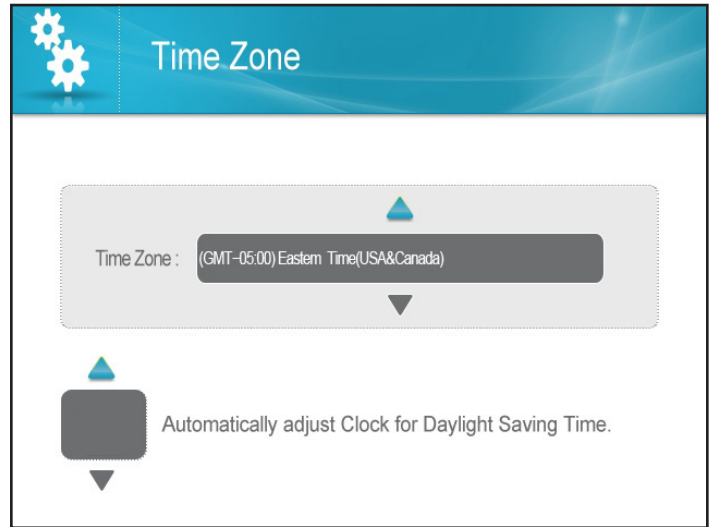

4. Use UP or DOWN navigation arrows to choose the desired Time Zone. Select the correct Time Zone and you will return to the Settings page

Daylight Savings

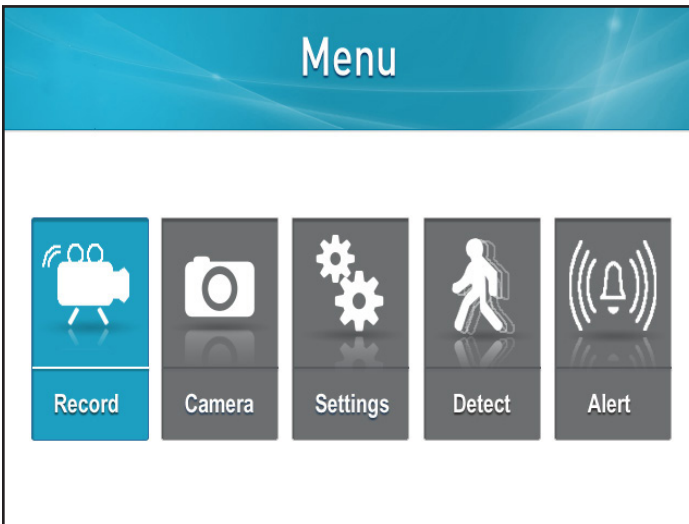

1. Press the Menu button

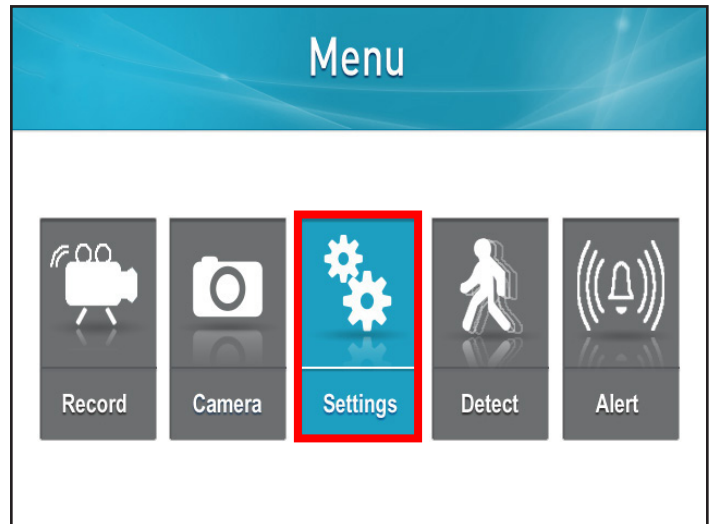

2. Select Settings

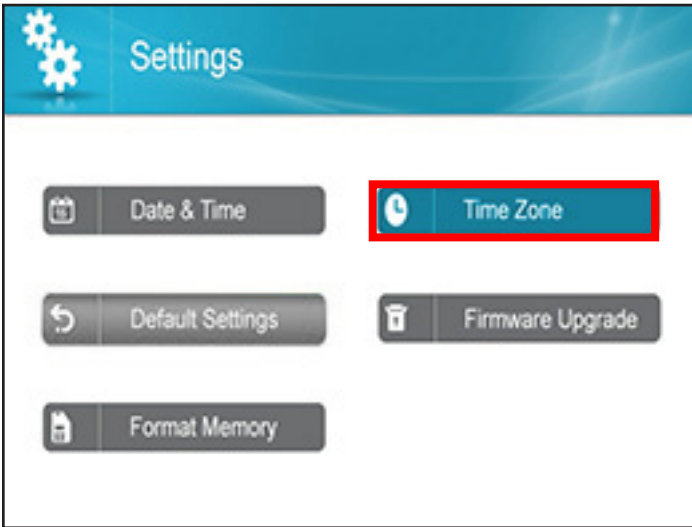

3. Select Time Zone

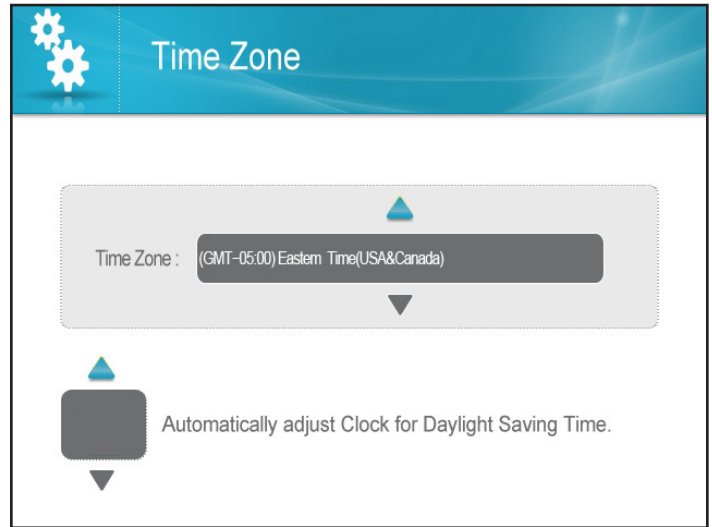

4. Use the RIGHT navigation arrow to highlight the Box next to Automatically adjust Clock for Daylight Savings Time

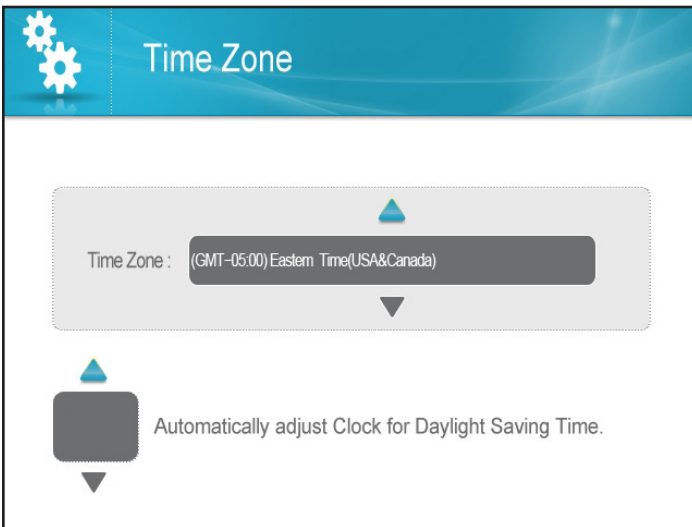

5. Use the UP navigation arrow until the Check mark appears. This will allow Daylight Savings Time to occur at the appropriate time. Leave the box blank if you do not wish for the time to change when Daylight Savings Time occurs

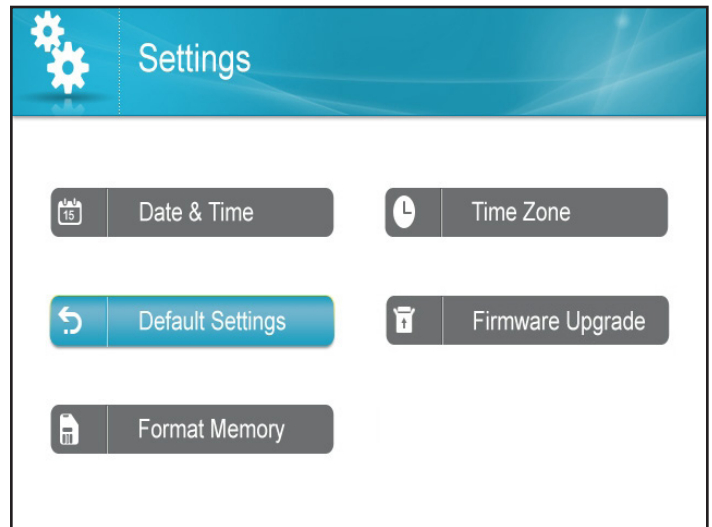

6. Press OK to save the settings and you will return to the Settings page

NOTE:
Time zone will automatically change time when daylight savings occurs in your time zone

Firmware Update

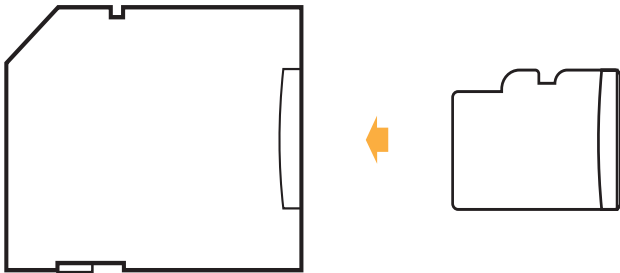

1. Insert the SD card into the included adapter

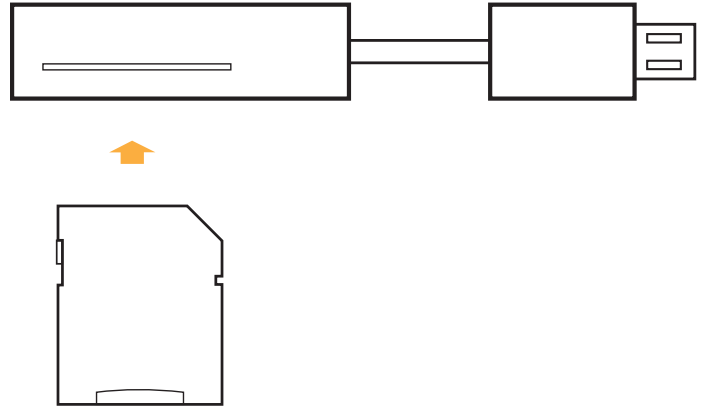

2. Insert the adapter into the SD card reader (not included) on your PC or Mac

NOTE:

A firmware Update should only be applied if available and recommended by a Defender representative.



3. Download the latest firmware and transfer it to the Main Folder on the SD card

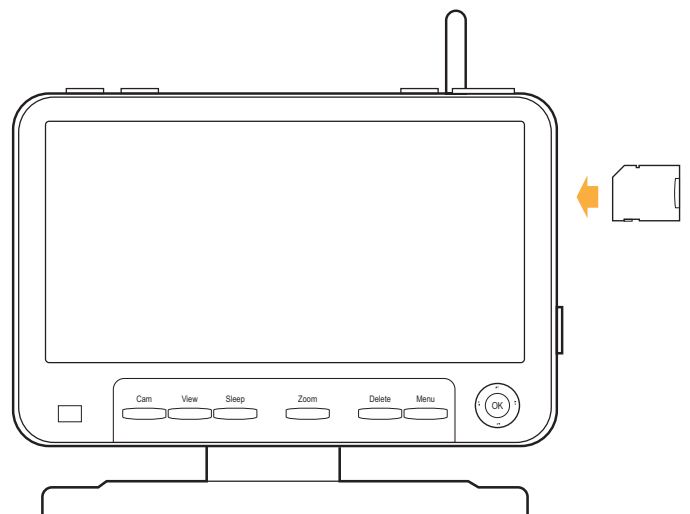

4. Once the transfer is completed, insert the SD card into the card slot on the monitor

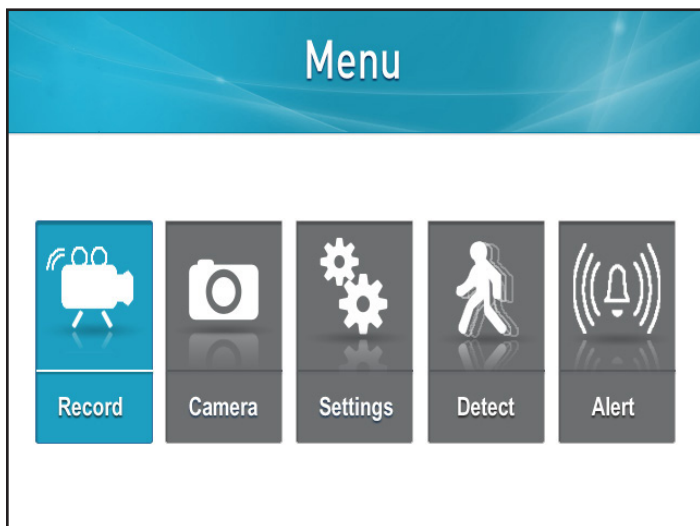

5. Press the Menu button

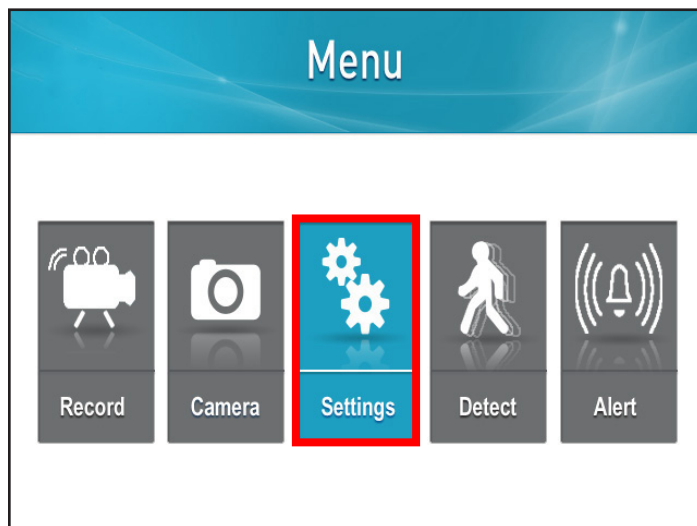

6. Select Settings

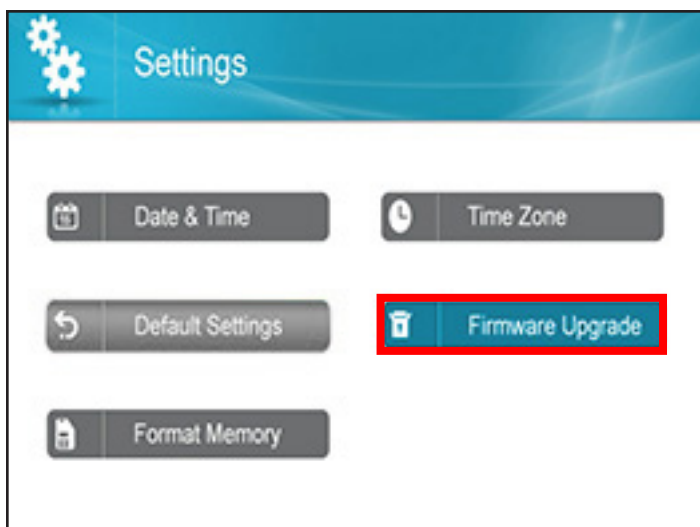

7. Select Firmware Upgrade

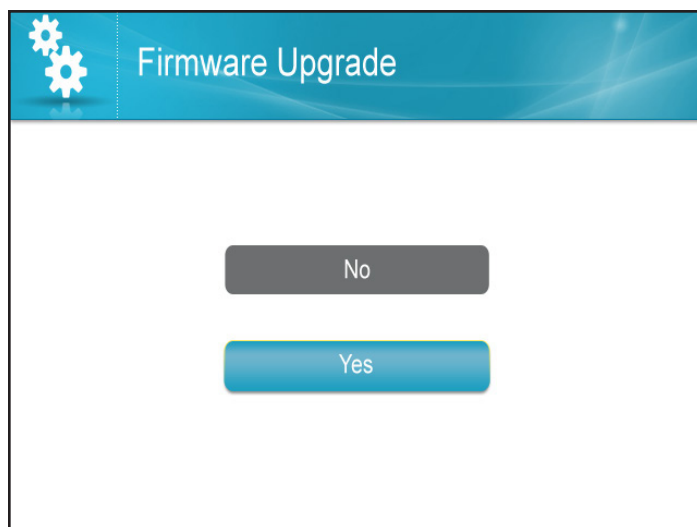

8. Confirm Firmware Upgrade



CAUTION:
During the firmware update do not remove the power supply

9. Select SD Card, and Yes to confirm. The system will take a few minutes to install the latest firmware. After upgrading the new Firmware, the monitor will automatically reboot

Setting Alert

An alarm will sound from the unit to alert you when motion has been detected. This also controls the beeps from the monitor when pressing buttons

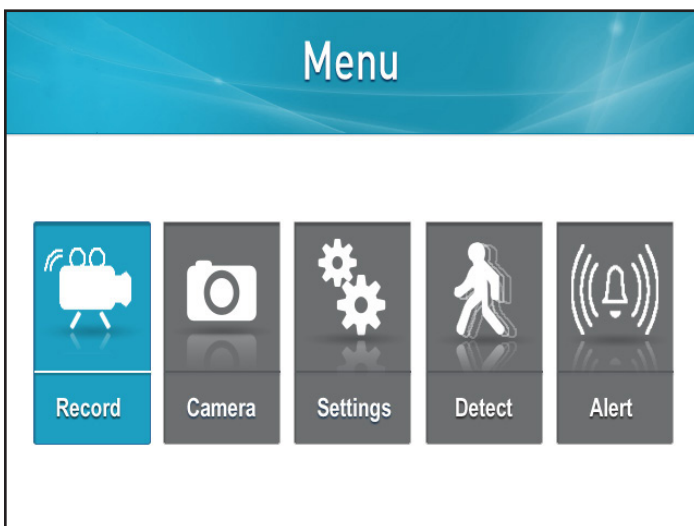

1. Press the Menu button

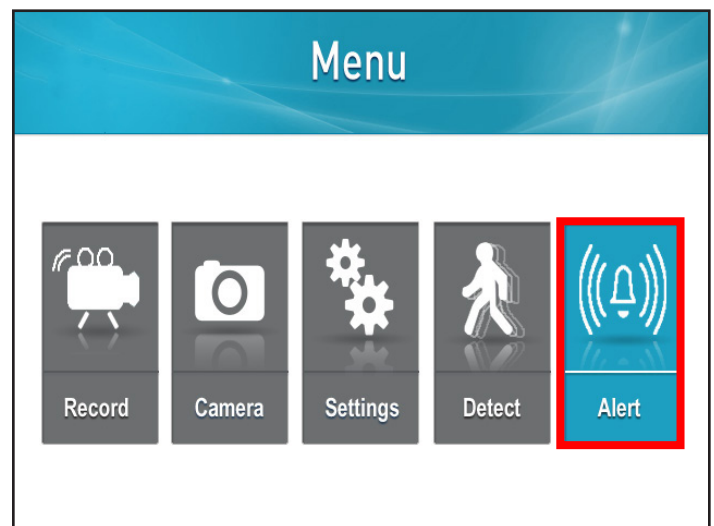

2. Select Alert

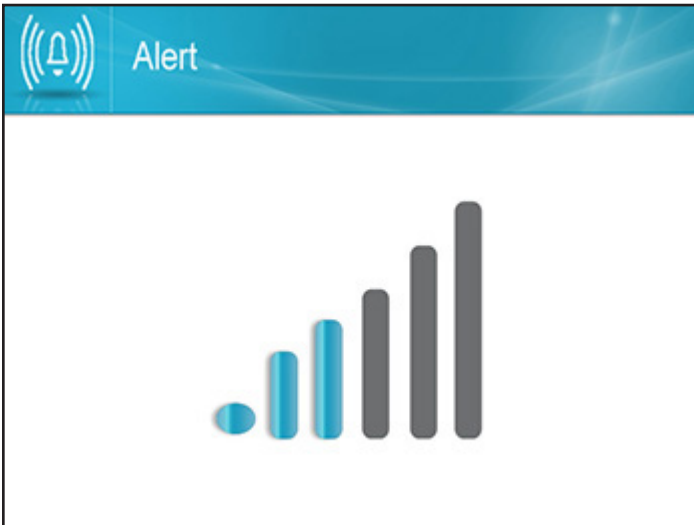

3. Use the LEFT or RIGHT navigation arrows to set Alarm Volume

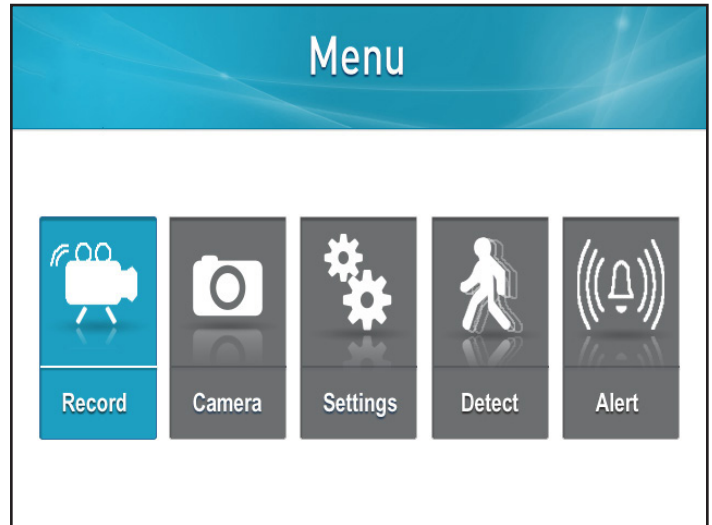

4. Press OK to save the setting and return to the Main Menu page

Playback Recorded Files

1. When in Live Viewing Mode, select the OK button. The Recording File List (below) will appear



2. Once you have selected the date from which you would like to view files, a list of files will appear

- Date:** You can change the date by using the UP or DOWN navigation arrows. Select OK when the desired date has been found.
- Calendar:** The areas that appear highlighted in Blue have recorded footage. Use the navigation arrows until a green box is over desired date select OK.
- Camera:** You can select to search footage for all cameras or for a specific one by using the RIGHT or LEFT navigation arrows to move Green box over the desired cameras(s) and select OK.



When watching videos you have the following options:

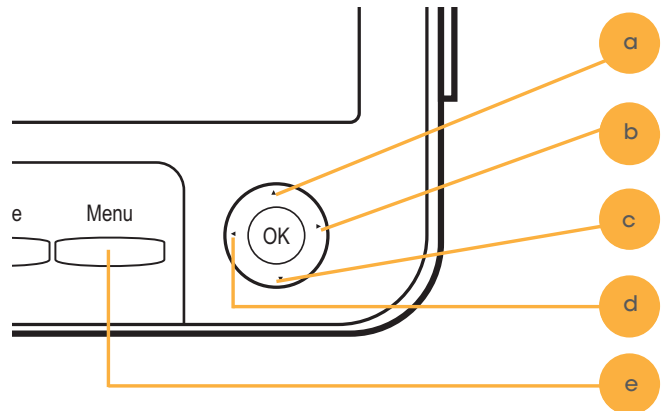

- a. **UP arrow/1:** Pause
- b. **RIGHT arrow/2:** Fast Forward
- c. **DOWN arrow/3:** Stop
- d. **LEFT arrow/4:** Rewind
- e. **Menu button/5:** Exit back to file list

3. Use the UP and DOWN navigational arrows until the Red box is around the desired file, then select OK. The recording will play on screen.

Deleting Individual Recorded Files



1. When in the Recording File List screen, use the navigation arrows to move the Red box around the file you would like to delete

2. Press the Delete button
3. Select Yes if you wish to delete and No to cancel

No Picture/Signal

- Make sure all the connections are secure and properly connected. *Found on page 8*
- Make sure your monitor is plugged into a power source from the 5V DC input on the back. *Found on page 8*
- Make sure there is nothing obstructing the view of the camera.
- Try re-pairing the camera and monitor. *Found on page 17*
- The area may be too bright or dark, try moving the unit.
- The night vision comes on automatically when the light levels drop; try the camera in a pitch black setting. The area that the camera is in may get too much light to activate the sensor.
- Try adjusting the brightness settings on your monitor. *Found on page 20*
- Ensure sleep mode is not enabled.

No Audio

- Make sure nothing is interfering with the microphone on the camera.
- Make sure what you are trying to hear is close enough to the microphone on the camera (within 6ft).
- Disconnect and reconnect the wires from the camera and the monitor to make sure they are secure.
- Try re-pairing the camera and monitor. *Found on page 17*
- Try adjusting the volume on the monitor. *Found on page 6*

Devices Are Not Pairing

- Ensure that the camera and monitor are within 100ft of each other.
- Try moving the devices closer together, sometimes walls/other obstructions can get in the way of the camera and monitor's signal. Ensure that both devices are connected to a proper power source.

Night Vision Not Working

- The night vision comes on automatically when the light levels drop; try the camera in a pitch black setting. The area that the camera is in may get too much light to activate the sensor.

Monitor is Reading No Signal

- Try re-pairing the camera and monitor. *Found on page 17*
- Make sure there is nothing obstructing the view of the camera.
- Make sure the camera and monitor are within 100ft from one another.

Footage Not Recording

- Adjust the recording settings
- Make sure the SD card is completely in the monitor.
- Make sure the SD card is not full and that overwrite function is turned on.
- Try resetting the factory defaults. *Found on page 25*
- Try formatting the SD card. *Found on page 27*

SPECIFICATIONS

Monitor	
Monitor Type	LCD Monitor
Screen Size	7" monitor
Wireless Frequency	2400Mhz~2483.5Mhz
Channel Frequencies	4Mhz channel separation
Number of Cameras Supported	4
Output Terminal	N/A
Resolution	800 RGB (H) x 480 (V)
Speaker	Yes
Maximum SD Card Size	256GB
Compression	MPEG-4
File Type	ASF
Operation Mode	FHSS hopping
Scheduled Recording	Yes
Automatic Overwrite when Full	On/Off selected.
Motion Activated Alert	Yes
Post Motion Recording	Yes
Audio Activated Recording	No
Digital Zoom	Yes (x2)
Auto-Scanning	Auto sequence channel, the transition interval is 6 seconds
Button Lock	N/A
Remote Control	No
New Video Footage Notifier	Yes
Viewing Modes	Single view, 2-CH view, Quad view
Recording Mode	Manual recording, Motion recording, Schedule recording
Battery Operable	No
Adjustable Brightness	Yes
Video Output	No
Operating Temperature	14°F-104°F (-10°C-40°C)
Operating Humidity	0% ~ 85%
Housing Material	No
Housing Color	black
Monitor Power Input	DC 5V 2A
Power Adapter Input	AC 100~240V 50/60Hz
Dimensions	180*142*70mm
Weight	444g

Camera	
Image sensor	1/4" Color CMOS Image Sensor
IP Rating	IP65
Maximum Wireless Range (Line of Sight)	450 ft
Optimum Wireless Range (Line of Sight)	150 ft
Wireless Frequency	2400Mhz~2483.5Mhz
Wireless Channel Frequencies	Hopping Frequencies
Resolution VGA	640 x 480
Night Vision	Yes
Number of IR LEDs and Range	16 LEDS 32Ft
IR LED control	Auto
IR Cut Filter	Included
Min. Illumination	0 Lux (when IR LEDs on)
Battery Operable	No
Viewing Angle	64° (Field Of View)
Focal Length	3.6mm
Focus Type	Fixed Focus
Optimal Focal Distance	N/A
Microphone	Yes
Motion Detection	Yes
Housing Material	Aluminum & ABS
Housing Color	Black
Electronic shutter speed	1/60s~1/100,000s
Signal/Noise Ratio	50dB
Power LED Indicator	No
Camera Bracket	Yes
Operating Temperature	14°F - 04°F (-10°C - 40°C)
Operating Humidity	0% ~ 85%
Mounting Hardware	Included
Camera Power Input	9V DC 600mA
Power Adapter Input	100-240V ~ 50/60Hz
Dimensions	140*55*57mm
Weight	284g

DefenderCameras.com