



INTELLIGENT
BIOLOGY™

STOP X

A HOME-USE DEVICE FOR TREATMENT
OF MILD TO MODERATE FACIAL WRINKLES

USER MANUAL

MODEL: STOP U

TABLE OF CONTENTS

1. WHAT IS THE STOP X?	6
2. WHO CAN BENEFIT FROM STOP X TREATMENTS?	6
3. CONTRAINDICATIONS AND SAFETY INFORMATION	7
• CONTRAINDICATIONS	7
• ⚠ WARNINGS	8
• ⚠ PRECAUTIONS AND SAFETY INSTRUCTIONS	9
• ⚠ FIRE HAZARDS	9
4. WHAT'S INSIDE THE STOP X BOX	10
5. GETTING TO KNOW YOUR STOP X DEVICE	11
• TREATMENT HEAD	11
• CONTROL PANEL	11
• POWER SUPPLY	12
• STOP PREPARATION GEL	12

6. STOP X TREATMENT PROCEDURE	13
• HOW OFTEN TO USE YOUR STOP X	13
• TREATMENT SAFETY GUIDELINES	13
• FIRST TIME USE	13
• BEFORE STARTING	14
• HOW TO APPLY STOP PREPARATION GEL	14
• HOW TO CONNECT THE POWER SUPPLY AND START THE DEVICE	15
• TREATMENT PROCEDURE	16
7. CLEANING AND STORAGE	18
8. TROUBLESHOOTING	18
9. TECHNICAL SPECIFICATIONS	19
10. SYMBOLS AND LABELS GLOSSARY	20
11. CUSTOMER SUPPORT	21
12. WARRANTY TERMS	21
13. APPENDIX I – WRINKLE FORMATION	22
14. APPENDIX II – CLINICAL TRIAL	22
15. APPENDIX III – OUTPUT POWER VS. LOAD RESISTANCE	23
16. APPENDIX IV – ELECTROMAGNETIC COMPATIBILITY	24

1. WHAT IS THE STOP X?

Use the STOP X at home to help reduce the appearance of mild to moderate facial wrinkles.

STOP X uses a mild energy source that heats the skin and treats the wrinkles.

Indications for Use:

The STOP X device is intended for use in the non-invasive treatment of mild to moderate facial wrinkles for adult users who have Fitzpatrick Skin Types II-IV*.

*** See section 3 for contraindications and safety information.**

The STOP X device is a radio frequency (RF) device, based on the well-established TriPollar® technology. The technology is based on four electrodes designed to transmit thermal (heat) energy into the deep layers of the skin, in order to trigger collagen remodeling that will reduce the appearance of wrinkles and improve your skin tone and texture. TriPollar® Radio Frequency technology combines the delivery of controlled heat deep into the skin, while preserving the external layer - the epidermis.

2. WHO CAN BENEFIT FROM STOP X TREATMENTS?

Adults who have mild to moderate facial wrinkles and want to decrease them using a home device.

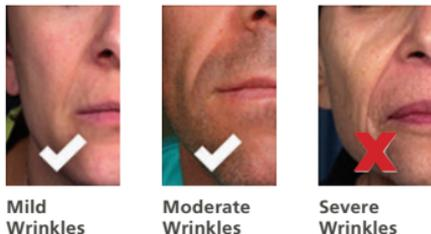

FIG.1 Who can benefit from STOP X treatments

3. CONTRAINDICATIONS AND SAFETY INFORMATION

CONTRAINDICATIONS

⚠ Do not use the STOP X if you have any of the following:

- An implanted pacemaker, arrhythmias, or any other severe known heart disorder. Flow of electrical energy through the body may damage the pacemaker and cause dangerous heart arrhythmias.
- An implantable metal device or body piercing in the treatment area. Flow of electrical energy through the implanted metal may heat the object and cause burns.
- You currently have or have had a history of cancer or pre-cancerous moles.
- You currently have diseases such as heart problems, autoimmune disorders,

- cancer and use of immunosuppressive medications.
- You have skin problems or irritations on your face.
 - You are under 21 years of age.
 - You are allergic to glycerin.
 - Suffer from autoimmune disorders or diabetes.
 - Currently using or used isotretinoin (Accutane) within the past six months. Using this device after using isotretinoin can cause severe scarring or more serious injury to your skin.
 - Have Fitzpatrick skin type I (light, pale white skin) or V (brown, dark brown) or VI (very dark brown, black). The safety and effectiveness of the device when used in individuals with pale skin (type I) or darker skin (types V or VI) or may be prone to skin discoloration has not been established (See Fitzpatrick Scale - **FIG.2**).

The Device should be used only for skin types 2,3,4.



FIG.2 Fitzpatrick Scale

Precaution is required before using the device if any of the following relate to you:

- You use medications or cosmetic products that may cause fragile or dry skin.
- You currently have or have had in the past cold sores (Herpes) or other conditions sensitive to heat.
- You recently had any facial aesthetic procedure, such as fillers, Botox, skin peeling or other wrinkle treatments.

Skin healing in these cases may be impaired:

- Lesions on the treatment area.
- Blood clotting disorders.
- Use of blood thinning medications.

Safety and effectiveness of the device was not tested in the following conditions or anatomical locations; therefore, DO NOT use STOP X under the following circumstances:

- If you have severe, deep wrinkles.
- If you are pregnant or breastfeeding.
- If you have moderate or severe wrinkles underneath the chin.
- Over the eyelids due to the potential damage to the eye structures.
- Over the eyebrows, eyeballs, lips, ears, thyroid, breasts or genital area.
- Use in subjects without total removal of facial hair may result in follicular burn in these areas.
- Do not use the STOP X device over any areas other than the recommended areas in this user manual (**FIG.10**).
- Do not use the STOP X device without the supplied treatment gel. The

device may not operate properly if used without the STOP preparation gel or if used with another lotion or gel.

Eye damage, damage to glands, sensitive and delicate skin and other tissue may occur. Follow instructions for use exactly as directed for your safety:

- The device is intended only for a single user to prevent contamination between users.
- During treatment, in case of excessive redness or swelling, stop treatment and cool the area using a wash cloth and cold water for at least 15 minutes.
- If redness persists for more than 24 hours after the treatment, please consult your physician.
- Patients with visual difficulties should use the device only while wearing corrective vision aid.

Skin injury can occur under this condition:

- Using blood thinning medications may induce skin hematomas due to the mechanical massage by the device.

If in doubt about any other medical condition or medication that might affect the treatment, please consult with your physician or contact us at info@pollogen.com.

⚠ PRECAUTIONS AND SAFETY INSTRUCTIONS

Remember, this is an electric device using radio frequency waves. Please adhere to the following precautions:

- Use this device only for its intended use as described in the user manual.

- Do not use the device if it is damaged or an item is missing.
- Turn the device on only during treatment.
- Do not use the device if it is disassembled, cracked or if the electric cord is damaged.
- Do not use the device in the vicinity of inflammable liquids (alcohol, acetone).
- Always thoroughly dry your hands and face before treatment.
- Keep out of reach of children.
- Do not place, store or use the device near sources of water such as the sink or bathtub.
- Do not touch the device if it is wet or falls in to water. Unplug the power supply from the electrical outlet immediately and then take the device out of the water. This situation could damage the device or power supply, or cause an electric shock that may lead to serious injury or death.
- Immediately after use, or before cleaning the device, turn the device off and unplug it from the electrical outlet.
- Only use the power supply supplied with the STOP X device. Using a different power supply can damage the device.

⚠ FIRE HAZARDS

- Do not use the device close to explosive or highly flammable materials (alcohol, methanol, acetone, etc.).
- If alcohol is used for cleaning the device, it must be allowed to dry thoroughly before the device is used and then move the alcohol away from the device.

4. WHAT'S INSIDE THE STOP X BOX

STOP X kit includes:

- STOP X DEVICE
- POWER SUPPLY
- STOP PREPARATION GEL

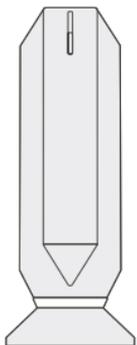

STOP X Device

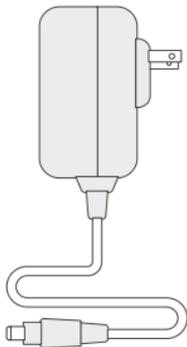

Power Supply

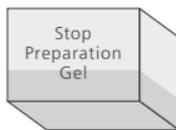

Stop Preparation Gel

FIG.3 In the box.

Check that the box includes all items.

⚠ Important

Do not use the device if it is damaged or an item is missing.

Check that there is a sticker on the protective cover.

If your device does not have this sticker, DO NOT USE and contact STOP X customer service at info@pollogen.com

5. GETTING TO KNOW YOUR STOP X DEVICE

The STOP X device consists of a body and a protective cover.

The device's body has a treatment head on one side and a control panel on the other side.

TREATMENT HEAD

The treatment head has four energy tips (electrodes) and a temperature sensor. When not in use, the treatment head should be covered with its protective cover (**FIG.4**).

CONTROL PANEL

The control panel includes the ON/OFF power button, power supply connection, heating level indicator light (green) and temperature range indicator light (orange) (**FIG.4**).

1. DEVICE BODY
2. TREATMENT HEAD
3. CONTROL PANEL
4. ENERGY TIP
5. TEMPERATURE SENSOR
6. POWER SUPPLY CONNECTION
7. ON/OFF BUTTON
8. GREEN INDICATOR LIGHT
9. ORANGE INDICATOR LIGHT
10. PROTECTIVE COVER

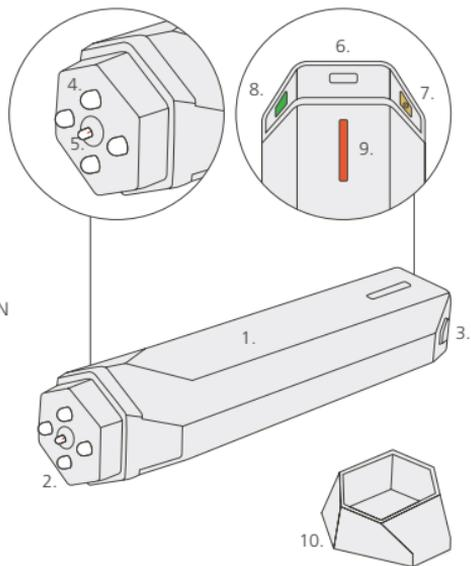

FIG.4 STOP X Device Overview. Check that the box includes all items.

POWER SUPPLY

The power supply is equipped with a built-in electric plug adapter and power supply cord (**FIG.5**)

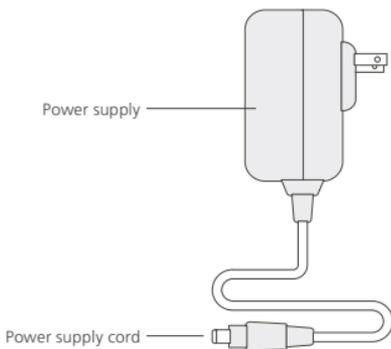

FIG.5 Power Supply

STOP PREPARATION GEL

STOP preparation gel is required for use with the STOP X. After opening the container, the STOP preparation gel can be used for 12 months.

6. STOP X TREATMENT PROCEDURE

HOW OFTEN TO USE YOUR STOP X

For best results, use the STOP X device 2-3 times (not consecutive days) a week for a period of 8-12 weeks. For maintenance: additional treatments are recommended once a week.

TREATMENT SAFETY GUIDELINES

- Be sure that all four energy tips firmly touch the skin at all times during treatment.
- It is important to keep the device moving at all times during treatment. **Leaving the device on the same spot without movement may result in skin overheating and possible excessive skin redness.**
- **For most effective treatment, use slow, circular movements.**

FIRST TIME USE

Before your first treatment, perform a test on a small area of skin (forearm, 2"x2"). This will ensure that your skin does not have a negative reaction (excessive redness and/or swelling) to the gel or treatment and that the device is operating correctly.

- Apply a small amount of STOP preparation gel on the test area
- Treat the area with the STOP X. Follow the steps below:
 1. Remove the protective cover.

2. Press the On/Off button.
3. Make sure the heating level green indicator light is on.
4. Place the device on the skin, and using slight pressure ensure that all 4 energy tips touch the skin.
5. Move the device slowly in circular motions until the orange indicator light comes on.
6. After the orange light comes on, continue treating the same area for a few more seconds.
7. Check if your skin has a negative reaction (excessive redness and/or swelling).

BEFORE STARTING

- Remove all jewelry, piercing and eye glasses (if you wear them).
- Sit in front of a mirror during treatment so you can see the orange temperature indicator light.
- Clean your face with soap and water and dry thoroughly.
- Make sure your hands are clean and dry.

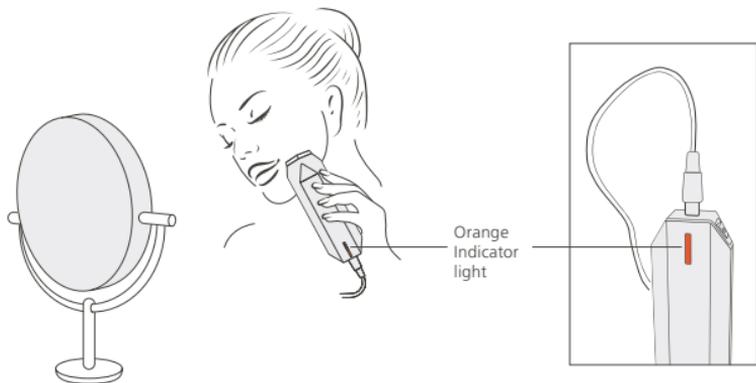
**FIG.6 Orange indicator light**

HOW TO APPLY STOP PREPARATION GEL

1. Dab a small amount of gel on your fingertip from the surface of the STOP preparation gel.
2. Dab small spots of gel around the face.

▲ Important

Be careful not to apply gel into your eyes.

3. Evenly spread a thin layer of the gel onto the face.
4. Clean your hands.



FIG.7 Applying STOP preparation gel

HOW TO CONNECT THE POWER SUPPLY AND START THE DEVICE

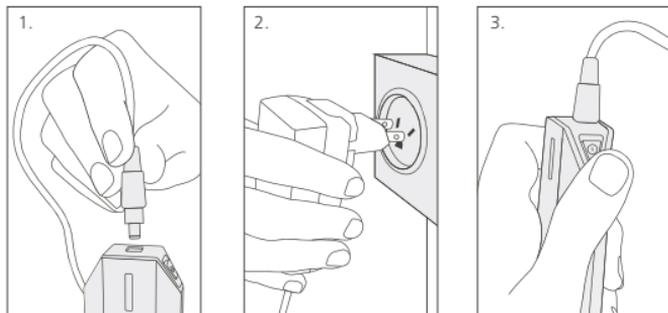

FIG.8 How to connect the power supply and start the device

1. Connect the power supply cord to the device. You should hear a "click" indicating that the connector is in place.
2. Plug the power supply into an electrical outlet.
3. Press the On/Off button to turn the device on.
4. Make sure the heating level green indicator light is on.

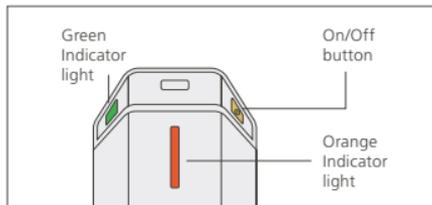

FIG.9 Control panel

TREATMENT PROCEDURE

Identify the parts of your face that you wish to treat. Divide your face into several treatment areas.

Treatment time is up to 2-3 minutes for each treatment area. Total treatment session should not exceed 20 minutes.

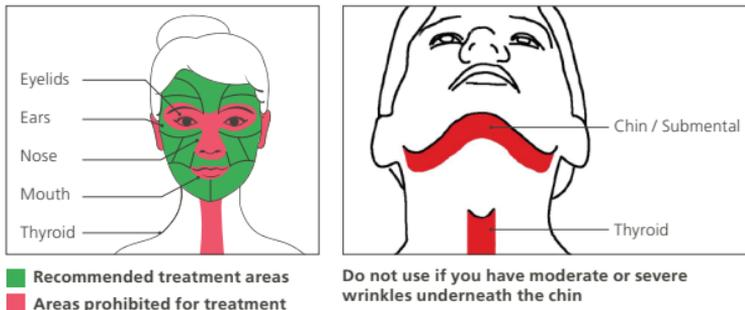

FIG.10 Recommended and prohibited treatment areas

⚠ Important

Never treat directly on eyes / eyelids, lips, nose, ears or thyroid.

TREATMENT PROCEDURE

1. Remove the protective cover.
2. Press the On/Off button.
3. Start on the lower cheek and jawline (**FIG.11**).
4. Place the device on the skin, and using slight pressure **ensure that the 4 energy tips touch the skin at all times.**

5. Move the device slowly in circular motions until the orange light turns on. This indicates that the skin has reached the desired temperature. This can take 2-3 minutes. You will feel a warm sensation on your skin. **(FIG.12)**
- **During the treatment you must keep the device constantly moving.**
 - If your skin begins to feel too hot, expand the treatment area or move slightly faster.
 - If the orange light does not come on, perform a slower movement **(FIG.13)**.

⚠ Important

Do not stop the motion of the device on the skin.

6. After the orange light comes on, continue treating the same area for a few more seconds.
7. Expand the treatment area; move to an adjacent area and continue the treatment.

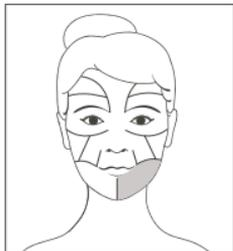

FIG.11 Start treatment on the lower cheek and jawline



FIG.12 Circular motions

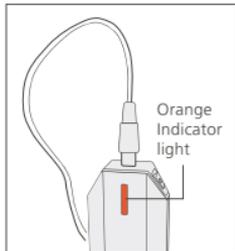

FIG.13 Orange indicator light

Safety feature that protects the skin from overheating

The device has a safety feature that protects the skin from overheating. You will know it is activated when the orange light is on, and the green light is off. The device will turn back on when you move to the next treatment area.

Immediate skin response

During the treatment, your skin may become slightly red and /or swollen. This is normal and will disappear soon after the treatment is finished.

⚠ Important

In case of excessive redness or swelling, stop treatment and cool the area using a wash cloth and cold water for at least 15 minutes.

After treatment

1. Turn OFF the device by pressing continuously the On/Off button for 2-3 seconds.
2. Unplug the power supply from the power outlet.
3. Disconnect the power supply from the device.
4. Gently clean your skin and remove the STOP preparation gel.

Possible side effects

Possible side effects may appear either at the time of treatment or shortly after. Side effects may include any of the following: prolonged pain, damage to natural skin texture (such as crusting, blister, burn, bruising, and fragile skin), excessive skin redness or swelling, and mild headache. Although these effects are rare and expected to be temporary, if they continue for more than 24 hours, please consult your physician.

7. CLEANING AND STORAGE

1. Use 2-3 disposable baby wipes to remove any gel residues.
2. Use a soft cloth, moistened with detergent solution disinfectant for 5 minutes, to clean the treatment head and electrodes until they are visibly clean.
3. Use a new soft cloth, moistened with tap water for 15 seconds, to remove detergent residue.
4. Use a dry soft cloth to dry the treatment head and electrodes.
5. Use a soft cloth, moistened with medical grade 70% alcohol solution for 1 minute, to wipe the treatment head and electrodes.
6. Spray the treatment head and electrodes with medical grade 70% alcohol solution, then wipe with a dry soft cloth. Be careful not to spill any liquids into the device.
7. If dirt residues are not fully removed, repeat cleaning steps 1-6.
8. Attach the protective cover to the device and store the device in a safe place.

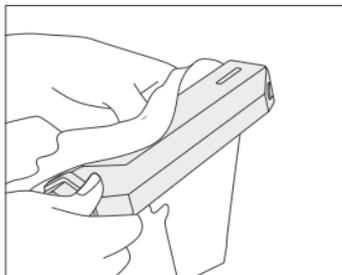

FIG.14 Cleaning the device

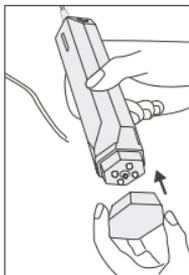

FIG.15 Attach the protective cover

8. TROUBLESHOOTING

In the event that your STOP X device is not working, prior to contacting the service center, take the following precautions:

1. Make sure you have removed the device's protective cover before use.
2. Make sure the electric cord is securely connected to the device until "click" is heard.
3. Make sure that the On/Off button was pressed and the green indicator light is on.
4. Make sure you have applied the STOP preparation gel according to the instructions above. The STOP X will not work properly if the preparation gel is not applied.
5. If the orange light does not turn on:
 - Move the device slower.
 - Be sure there is not too much gel applied on the face.
6. If you feel the device stops heating the skin, the orange light is on and the green light is off, move to the next treatment area and check that device turns back on.

9. TECHNICAL SPECIFICATIONS

Technical Specifications

Weight:	85gr
Physical Dimensions:	H=134mm L=51mm W=32mm
TriPollar RF Frequency:	1MHz
Input:	100-240VAC 50/60 Hz 0.4A
Output Voltage:	DC 8V
Output current:	1.5A

Operating conditions

Temperature:	+5°C to +30°C
Humidity:	20RH to 80RH
Atmospheric pressure:	80 kPa to 106 kPa

Transport and Storage

Temperature:	0°C to 40°C
Humidity:	10RH to 90RH
Atmospheric pressure:	50 kPa to 106 kPa
Electrical Safety:	Medical Grade Power supply classified as Class II
Product Lifetime:	7 Years
Output power	6W @ 200 OHM

STOP preparation gel contains 1.7 oz/50ml.

10. SYMBOLS AND LABELS GLOSSARY

	Caution
	Consult instructions for use
	Batch code
	Catalogue number
	Serial number
	Type BF applied part (Degree and type of protection against electric shock)
	Date of Manufacture
	Manufacturer
	Floating Connection
	WEEE wheeled bin. This product contains electrical and electronic components that may contain materials which, if disposed with general waste, could be damaging to the environment. This product must be disposed or recycled in accordance with local laws or regulations that apply.
IP22	2 - protection against particulate matter; 2 - protection against ingress of water

11. CUSTOMER SUPPORT

Prior contacting your local distributor for service and support, please have the device serial number ready. The serial number can be found on the top panel of the device.

Customer satisfaction is our top priority. If for some reason you are not satisfied with the product, we want to know about it. You may contact Pollogen directly via:

International e-mail: service@pollogen.com / Tel: +972-3-5104110

 Pollogen Ltd., 6 Kaufman St., PO Box 50320, Tel Aviv 6801298 Israel

12. WARRANTY TERMS

This product has been subjected to strict quality control performed by the manufacturer. For this reason, the distributor in your country guarantees proper function of your product for 24 months from date of actual purchase. If you use the device properly, follow all instructions outlined in the user manual, you can enjoy the product to your ultimate satisfaction.

This policy warrants the support that the distributor provides for the device, should it happen that failures attributable to manufacturing defects be found. In such case, you shall be entitled to make full use of the benefits of this warranty. This implies the reason and replacement of parts, free of charge (regarding both service and parts) at any Authorized Service Center. Within

its validity term, you are entitled to make use of the warranty if necessary to have a fully enjoyable product, provided the above-indicated conditions are fully met. This warranty is valid for the device marketed by the distributor in your country.

The warranty is not valid when:

1. Amendments in the warranty policy, sales receipt or invoice, or the absence of any of these original documents.
2. Damage or deterioration of the device due to improper use or if the device has been modified or repaired by an unauthorized third party.
3. Damage of the product due to defects incurred during transportation, such as bumps, bangs or improper handling.
4. Damage due to humidity or any kind of liquids, foreign bodies inside the device or the use of unapproved, unadvised accessories with the device contradictory to the user manual.
5. When the device is not used in accordance with the respective user manual or with its supplied accessories.
6. Partial or total damage or loss of the device, due to natural disasters (such as earthquakes, floods, fire, lightening, etc.), force majeure or accident.
7. Damage to the device after being subjected to high dust environments, humidity or application of excessive voltage from the power inlet.
8. If the product's serial number has been amended or erased.
9. To cosmetic damage, including but not limited to scratches and dents.

13. APPENDIX I - WRINKLE FORMATION

Collagen and elastin fibers are components in the deeper layer of the skin that give the skin its shape. The collagen fibers are responsible for skin strength and tone. The elastin fibers allow skin flexibility or elasticity. With aging, the collagen and elastin fibers weaken and the production of new fibers slows down. These structural changes cause the skin to loosen causing skin sagging and wrinkles (**FIG.16**).

The STOP X device is designed to improve the existing collagen fibers while triggering new collagen and elastin formation by reaching the deep skin layers – the dermis, where new collagen and elastin fibers form.



FIG.16 How wrinkles form

14. APPENDIX II – CLINICAL TRIAL

The benefits and risks of the STOP X model "STOP U" device were tested in a clinical study involving 40 participants, ages 35-65, in two sites within the United States, led by two investigators. Participants received 8 treatments by practitioners on the skin of their face for a 6 week period and there was follow up at 1 and 3 months after the last treatment. They were evaluated throughout the study for skin improvement and side effects.

Benefits

Over 80% (31/37) of the participants showed at least one grade improvement in Fitzpatrick wrinkle score at three months follow-up after treatment; There were no incidences of serious adverse events or complications; As expected, mild to moderate erythema and mild edema were detected at the site of treatment immediately after treatment; All cases resolved without treatment within few hours; Treatment was well tolerated with minimal to no pain in the majority of study subjects.

Risks

4 (1.3%) incidences of mild pain were reported in a total of 312 treatments; The study used a small sample size; the users were professionals; the users did not choose the device for themselves. Summary of Clinical Data.

The results of this study demonstrate that the STOP X model "STOP U" device provides a safe, tolerable and effective treatment for improvement of the appearance of facial wrinkles.

15. APPENDIX III – OUTPUT POWER VS. LOAD RESISTANCE

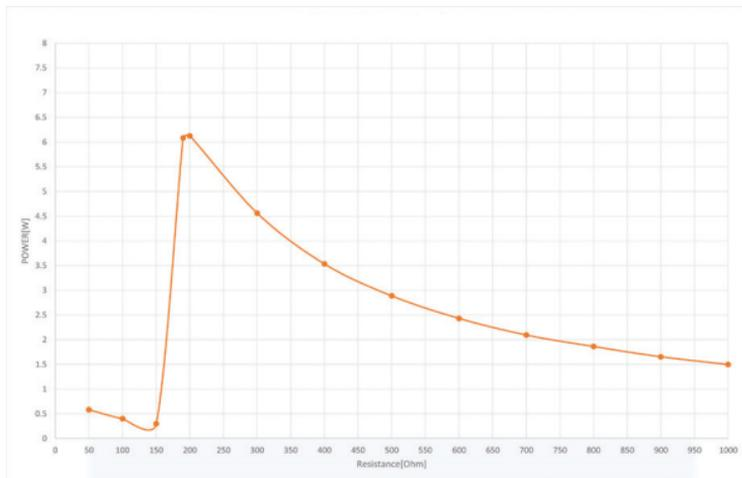

16. APPENDIX IV – ELECTROMAGNETIC COMPATIBILITY

Test	Standard	Class / Severity lever	Test result
Emission (IEC 60601-1-2 sec.7)			
Conducted emission Freq. range: 150 kHz - 30 MHz	CISPR 11	Group 2 Class B on 230 VAC, 120&100 VAC mains (PA)	Complies
Radiated emission Freq. ranges: 0.15 - 30 MHz; 30 - 1000 MHz	CISPR 11	Group 2 Class B	Complies
Harmonic current emission test	IEC 61000-3-2	AC mains	Exempt
Voltage changes, Voltage fluctuations and Flicker test	IEC 61000-3-3	AC mains	Complies
Immunity (IEC 60601-1-2 sec.8)			
Immunity from Electrostatic discharge (ESD)	IEC 61000-4-2	8 kV contact discharges & 15 kV air discharges	Complies
Immunity from radiated electromagnetic fields	IEC 61000-4-3	10.0 V/m 80 MHz+2.7 GHz, 80% AM, 1 kHz	Complies
Immunity from Proximity field from wireless communications equipment	IEC 61000-4-3	List of frequencies (Table 10), from 9 V/m up to 28 V/m, PM (18 Hz or 217 Hz), FM 1 kHz	Complies
Immunity from Electrical Fast transient (EFT)	IEC 61000-4-4	+2.0 kV on 230 VAC mains (PA), Tr/Th - 5/50 ns, 100 kHz	Complies
Immunity from Surge	IEC 61000-4-5	+1.0 kV DM/ +2.0 kV CM om 230 VAC mains (PA); Tr/Th - 1.2/50 (8/20) ns	Complies
Immunity from conducted disturbances induced by radio- frequency fields	IEC 61000-4-6	10.0 VRMS on 230 VAC mains (PA); 0.15 - 80 MHz; 80% AM, 1 kHz	Complies
Immunity from voltage dips, short interruptions and voltage variations	IEC 61000-4-11	0% - 0.5 cycle & 1 cycle; 70% - 25 cycles; 0% - 250 cycles on 230 AC mains (PA)	Complies

STOP X

MODEL: STOP U

 POLLOGEN LTD.

6 KAUFMAN ST.

GIBOR HOUSE P.O.BOX 50320

TEL AVIV, ISRAEL 6801298

TEL: +972(0)3 5104110

FAX: +972(0)3 5174112

EMAIL: INFO@POLLOGEN.COM

WEBSITE: WWW.POLLOGEN.COM

© POLLOGEN LTD., ALL RIGHTS RESERVED. 14700400US REV 5

DESIGN AND TECHNICAL SPECIFICATIONS ARE SUBJECT TO CHANGE WITHOUT PRIOR NOTICE.

MANUFACTURED AND DISTRIBUTED BY POLLOGEN LTD. MADE IN CHINA.

THE NAME STOP IS TRADEMARK OF POLLOGEN LTD.

THE NAMES POLLOGEN AND TRIPOLLAR ARE REGISTERED TRADEMARKS OF POLLOGEN LTD.

FOR MORE INFORMATION, PLEASE VISIT: WWW.STOP-AGE.COM