



SeeMeCNC™
3D Printers & More



Eris® Delta 3D Printer Manual

First Edition

v1.10 – January 27th, 2017

MatterControl v1.5

Copyright 2016 By Gene Buckle – geneb@deltasoft.com

Licensed as Creative Commons, Attribution-ShareAlike 3.0

Disclaimer text provided by LulzBot.

Official support is available through support@seemecnc.com

As a new SeeMeCNC printer owner, you'll also find a ton of great resources on the forums at forum.seemecnc.com

READ ME FIRST!

READ THIS MANUAL COMPLETELY BEFORE UNPACKING AND POWERING UP YOUR PRINTER!

Hazards and Warnings

The SeeMeCNC Eris® Delta 3D printer has motorized and heated parts. When the printer is in operation always be aware of possible hazards.

Electric Shock Hazard

Never open the electronics bay of the printer while the printer is powered on. Before removing the access door, always power down the printer and unplug the AC line cord.

Burn Hazard

Never touch the extruder nozzle or heater block without first turning off the hot end and allowing it to completely cool down. The hot end can take up to twenty minutes to completely cool. Also, never touch recently extruded plastic. The plastic can stick to your skin and cause burns. Also before of the heated bed which can reach high temperatures capable of causing burns.

Fire Hazard

Never place flammable materials or liquids on or near the printer when powered on or in operation. Liquid acetone and vapors are extremely flammable.

Pinch Hazard

When the printer is in operation, take care to never put your fingers in the moving parts, including the belts, pulleys or gears. Also, tie back long hair or clothing that can get caught in the moving parts of the printer.

Static Charge

Make sure to ground yourself before touching the printer, especially the electronics. Electrostatic charges can damage electronic components. To ground yourself, touch a grounded source.

Age Warning

For users under the age of 18, adult supervision is recommended. Beware of choking hazards around small children.

Table of Contents

1 – Unboxing your new Eris® Delta 3D Printer.....	4
2 – Installing MatterControl.....	5
3 – Calibrating the Eris®.....	10
4 – Loading and Unloading Filament.....	12
5 – First Print!.....	14
6 – MatterControl Basics: Slicing.....	15
7 – MatterControl Basics: Loading & Printing an Object.....	29
8 – Advanced MatterControl: Options.....	33
9 – Advanced MatterControl: Settings – Print.....	37
10 – Advanced MatterControl: Settings – Filament.....	47
11 – Advanced MatterControl: Settings – Printer.....	50
12 – Using the 3D View and Layer View.....	54
13 – A Strategy for Successful (and Great!) Prints.....	62

1 – Unboxing your new Eris® Delta 3D Printer

If you're one of the rare people that downloaded the manual BEFORE opening your new Eris®, SeeMeCNC has a treat for you!

We've produced a short little video that shows how to unpack your new Eris® as well as how to load filament for the first time!

[Eris® Unboxing and Setup Video](#)

2 – Installing MatterControl

MatterControl is the control program that you'll be using with your new Eris® printer. MatterControl is known as a combination host and “slicer”. Its “host” feature allow you to control the Eris® directly – moving the axes, heating the hot end, etc. The “slicer” feature is what converts a 3D model into a form suitable for printing. We'll cover that shortly.

You can download MatterControl by going to the SeeMeCNC website – <http://seemecnc.com/pages/downloads>. Scroll down to the “Software” heading and you'll see the links for MatterControl. Download the version for your platform and install it.

Note that the MacOS version is functionally identical to the Windows version, so I'll only be showing examples from Windows – the same procedures should apply to both versions.

You'll also want to download the Eris® Default Files from the Eris® page on the SeeMeCNC website: <https://www.seemecnc.com/collections/3d-printers/products/eris-desktop-3d-printer>. Look for the link marked “**DOWNLOAD ERIS SETTINGS HERE**”. Unpack the files so they're ready to use when you need them.

Start MatterControl. Below you'll see what the basic MatterControl interface looks like.

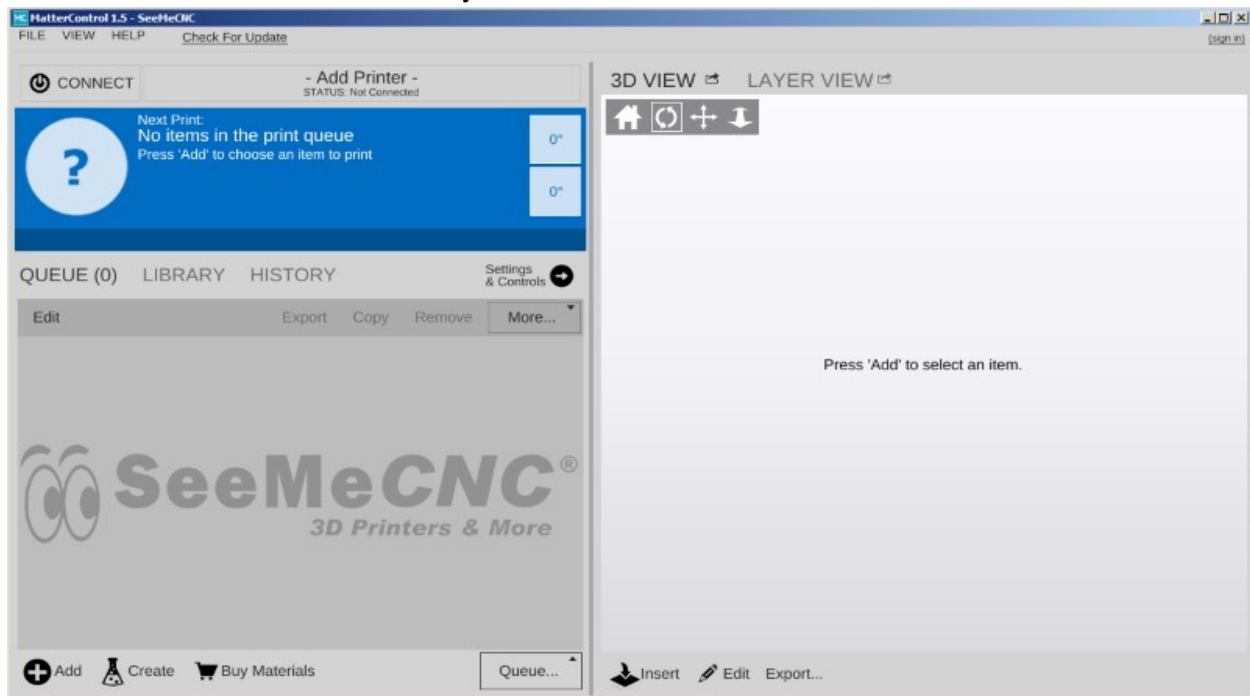

Your first step will be to configure MatterControl to use the Eris®. Simply click the “Add Printer” button that's located at the top of the left MatterControl pane.



When you click on the **Add Printer** button, you'll be presented with the dialog you see to the right. Click in the **Printer Name** field and enter the name of your new printer. Next, click the **Select Model** button and pick “Eris”.

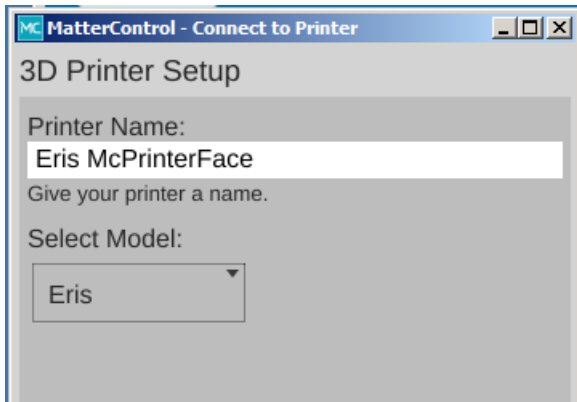
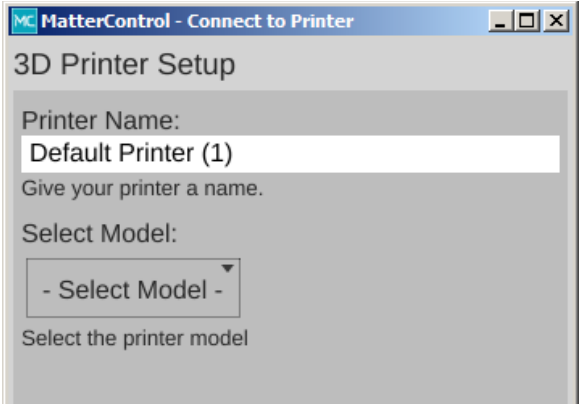

Click the **Save & Continue** button to move on to the next step.

Next, you'll be presented with the option to install the communication driver that MatterControl needs to talk to the Eris®. If you've used a RAMBo or Mini-RAMBo based 3D printer on your computer before, you can skip this step. Otherwise, click the **Install Driver** button to have MatterControl install the driver for you.

MatterControl will run a driver installer that will likely ask you for permission to continue. Please grant it and a dialog similar to the one below will appear. Click on the **Install** button to allow the driver to install.

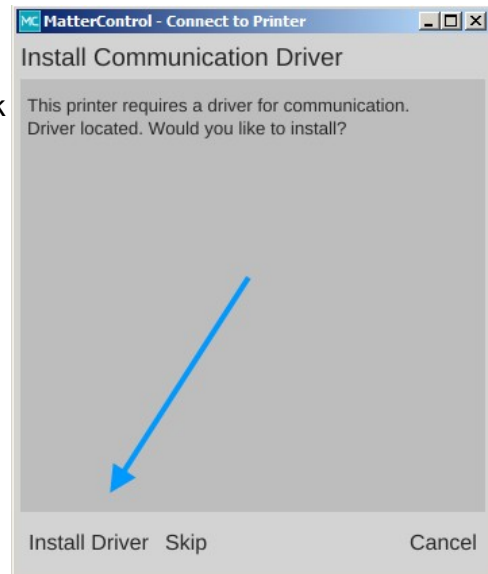

Once the installer finishes, MatterControl will attempt to automatically configure the connection. Please disconnect the Eris® and click the **Continue** button.

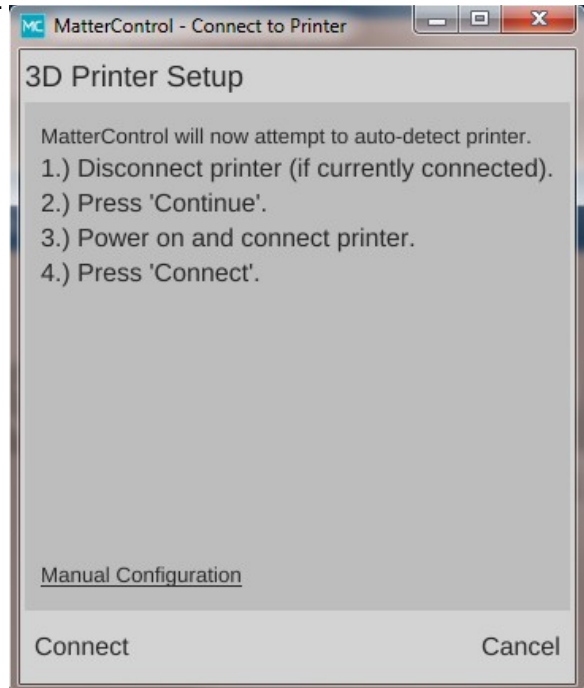

Once you click on **Connect**, the following dialog should appear:



Congrats! You're all done. Click on the **Done** button to continue.

The configuration process automatically loads a test object that you can print. Let's take a few minutes to go over the various features of the MatterControl interface.

The MatterControl interface is split into two halves. The left half is where you can load objects or G-code to print, start prints, and manually control the printer.

1. This is the print queue display. If nothing is queued up, you'll see the message, "No items in the print queue". To add an item, click the "Add" button (#13). We'll cover this in detail later. Note that you can only select STL or GCODE files.

2. This is the temperature display. The figure displayed shows the current nozzle temperature. If you ever install a heated bed on your Eris®, a second box will appear that will show the bed temperature. Both values are shown in degrees Celsius.

3. Queue Count. This shows the number of objects currently in the print queue.

4. Library – This is a list of items that you've stored in your object "library". We'll cover this one in detail later.

5. Print History. This will show you what you've printed in the past along with statistics about each print.

6. Settings & Controls – this is where you can edit your slicer & printer settings as well as manually control your Eris®

7. The **Edit** button will allow you to choose which items in the print queue will be available for printing.

8. The **Export** button will allow you to export the currently select item as an STL, AMF, or GCODE file. You can use this to save GCODE if you want to share your sliced object with another Eris® user.

9. The **Copy** button will make copies of the currently selected item in the print queue.

10. The **Remove** button will remove the currently selected item in the print queue.

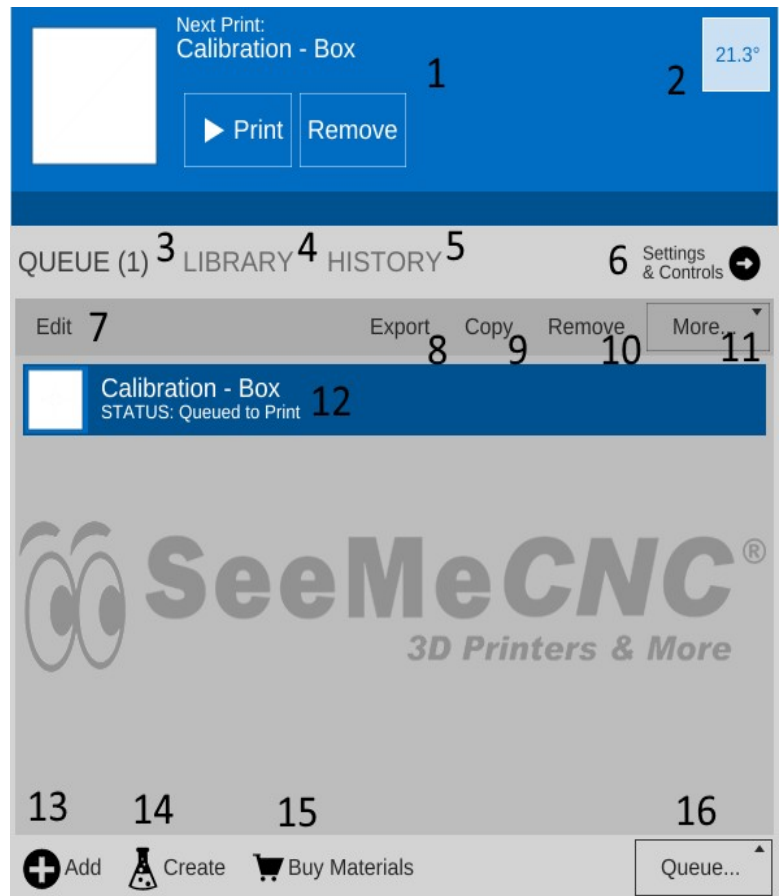

11. The **More** drop-down will allow you to send the currently selected item to another device, or to the print Library.
12. Items currently in your Queue.
13. The **Add** button will allow you to add objects or G-code files to the print queue.
14. The **Create** button displays a list of available plug-ins that are used to create printable objects right inside of MatterControl.
15. The **Buy Materials** button will open your web browser and point it to the SeeMeCNC store.
16. The **Queue** button opens a menu list that will allow you to export the current file and perform other operations on the print queue.

The right half of the MatterControl interface is taken up by a 3D view of your build platform and what objects are currently loaded and ready to print.

1. The 3D and Layer view controls allow you to switch between the 3D view (shown) and the Layer view. The layer view shows you the path the print head will take as your part is printed. The layer view won't display anything until the part you want to print has been "sliced".

2. View manipulation controls – Rotate, Pan, and Zoom. By default, the 3D view will show a rotating display of the part. You can stop the rotation by clicking anywhere in the 3D view window.

3. The object currently ready to print.

4. This is a representation of the print bed on your Eris®. As long as your object fits within the circle, you can print it!

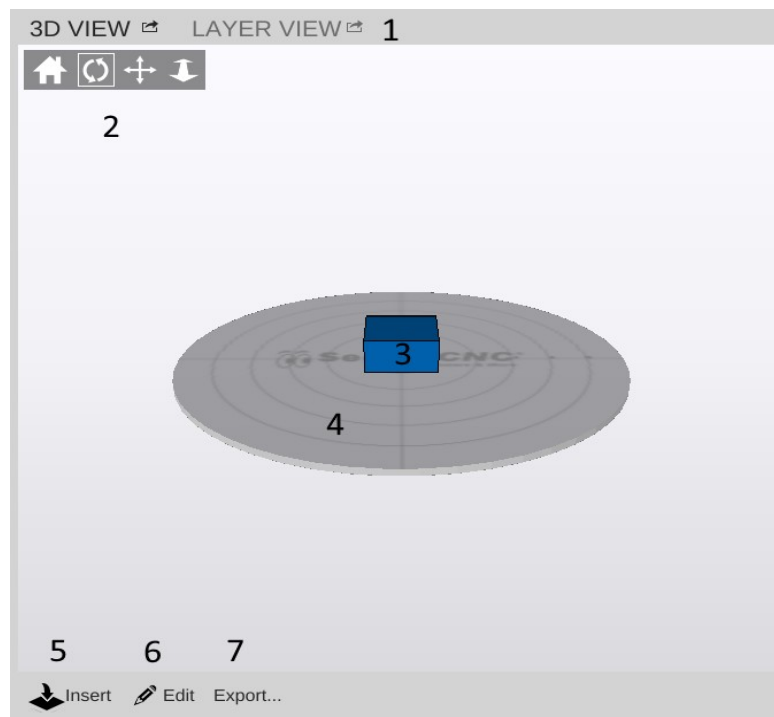

- 5 & 6 The **Insert** and **Edit** buttons allow you to add and manipulate multiple objects to the current print job. We'll cover this in depth later as well.

7. The **Export** button allows you to save the current state of the build plate in a few different file formats.

3 – Calibrating the Eris®

Before you can start using your new Eris®, we'll need to calibrate it first. This is really easy to do!

Click on the **Settings & Controls** button and then click on the **Options** button.

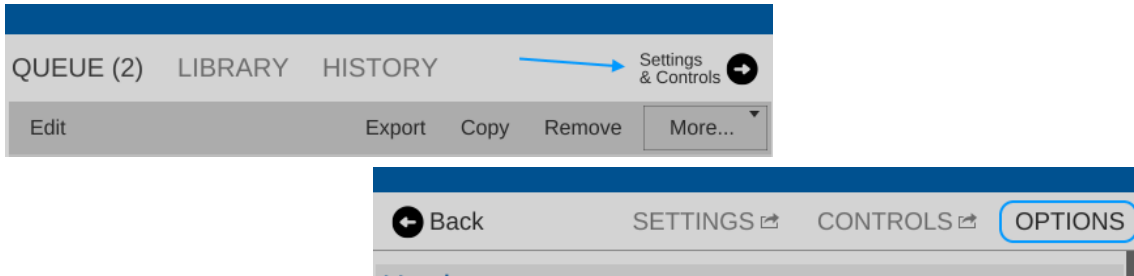

Once you're on the **Options** page, click on the **Show Terminal** button to open up the serial console.

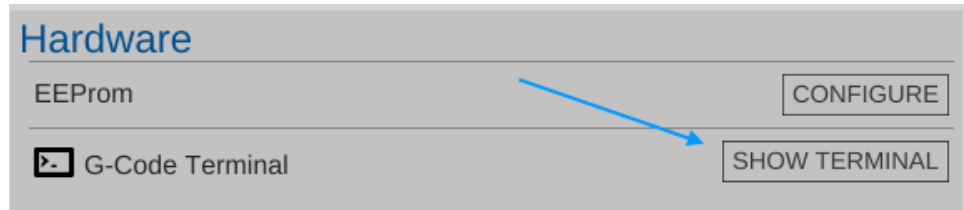

Before you proceed to the next step, make sure that the nozzle on the hot end is free from any filament or other debris. A clean nozzle will ensure a clean “hit” as the calibration routine probes the bed surface. You also want to make sure that you've got the hot end cold – the calibration process will not work reliably if the hot end heater is active.

Click in the input field as shown and enter **G29** and press the enter key.

This will run the calibration process on your Eris®!

This probing process works out a few basic parameters about your Eris® and is considered a “basic” calibration.

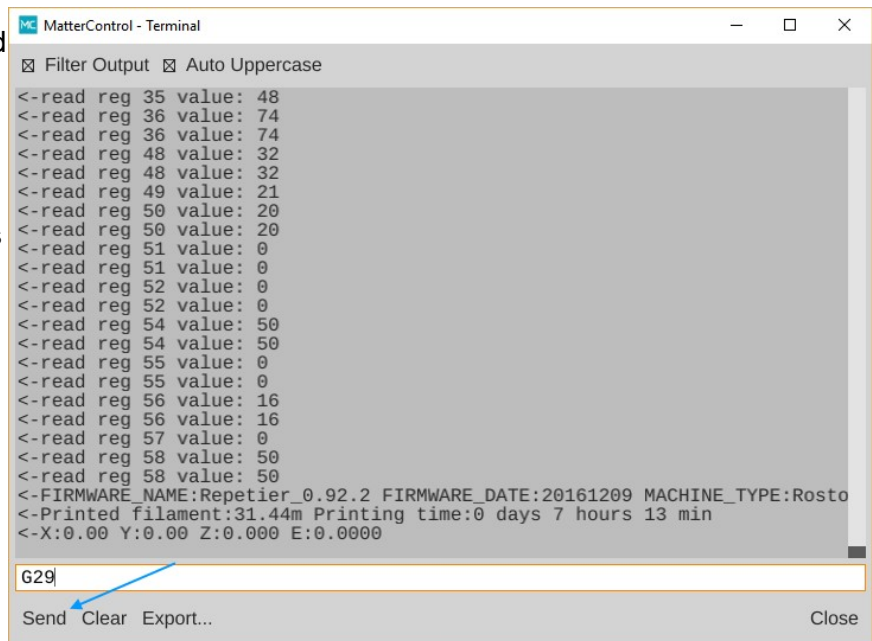

In order to obtain the best calibration possible for your Eris®, you should also use the online calibration wizard that SeeMeCNC has created. This tool is very easy to use and includes very detailed instructions on how to use it!

The calibration wizard can be found here:

<https://www.seemecnc.com/pages/delta-calibration-wizard>

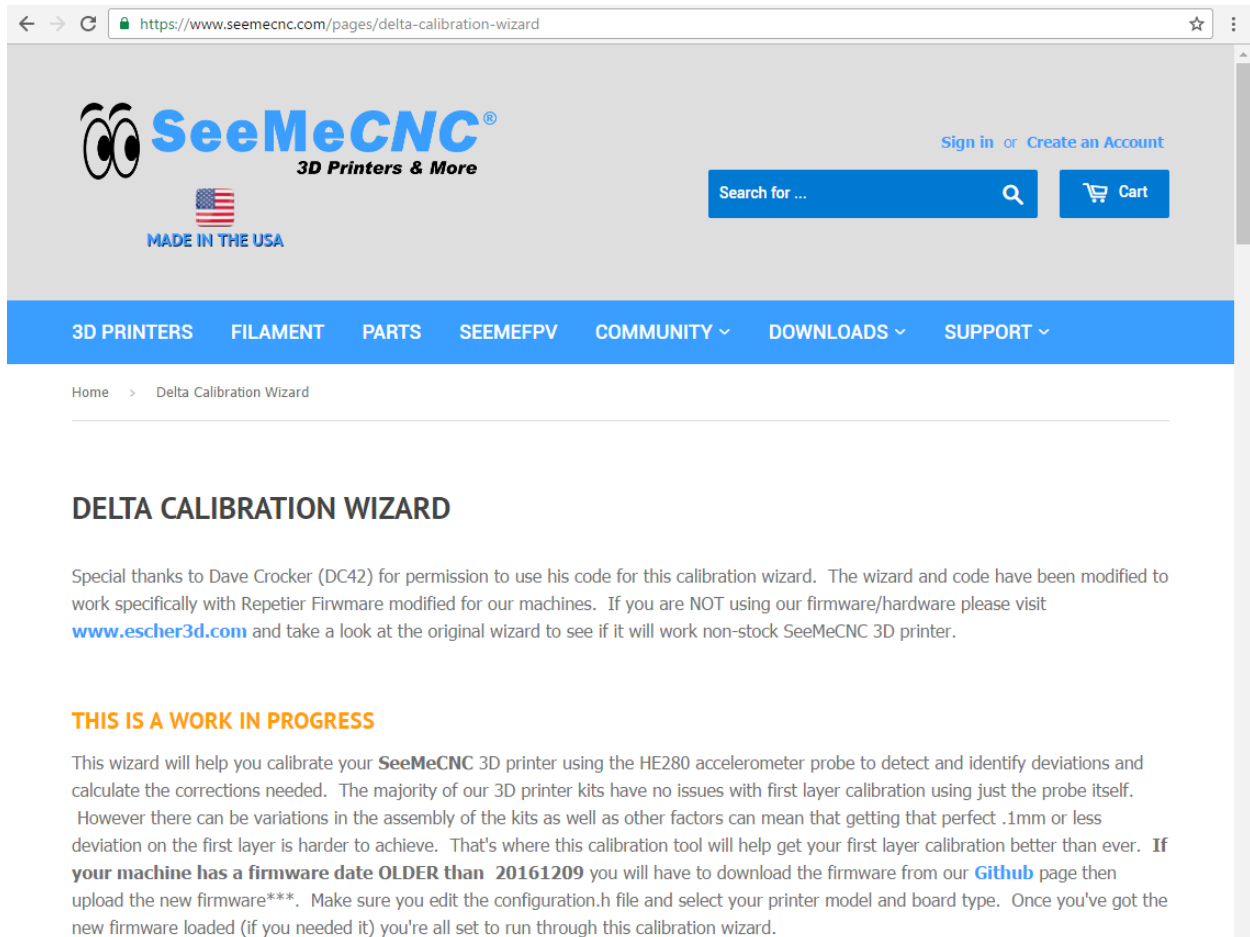

The screenshot shows a web browser window displaying the SeeMeCNC website. The browser's address bar shows the URL <https://www.seemecnc.com/pages/delta-calibration-wizard>. The website header features the SeeMeCNC logo with the tagline "3D Printers & More" and "MADE IN THE USA". Navigation links include "Sign in" and "Create an Account". A search bar and a "Cart" button are also visible. A blue navigation bar contains links for "3D PRINTERS", "FILAMENT", "PARTS", "SEEMEFPV", "COMMUNITY", "DOWNLOADS", and "SUPPORT". The main content area has a breadcrumb trail "Home > Delta Calibration Wizard" and a heading "DELTA CALIBRATION WIZARD". The text below the heading reads: "Special thanks to Dave Crocker (DC42) for permission to use his code for this calibration wizard. The wizard and code have been modified to work specifically with Repetier Firmware modified for our machines. If you are NOT using our firmware/hardware please visit www.escher3d.com and take a look at the original wizard to see if it will work non-stock SeeMeCNC 3D printer." A section titled "THIS IS A WORK IN PROGRESS" follows, with text explaining the wizard's purpose and providing instructions for users with older firmware: "If your machine has a firmware date OLDER than 20161209 you will have to download the firmware from our [Github](#) page then upload the new firmware***. Make sure you edit the configuration.h file and select your printer model and board type. Once you've got the new firmware loaded (if you needed it) you're all set to run through this calibration wizard."

4 – Loading and Unloading Filament

Loading new filament into your Eris® is a very straightforward task. First, you'll need to feed new filament into the filament guide tube on the Eris® as shown below:



Into the guide tube...

Open the filament tensioner by compressing it between your thumb and forefinger, then feed the filament into the EZStruder.



...to the EZStruder...



Compressing the filament tensioner.

Feed only enough filament to exit about 1" past the PTC fitting on the outfeed side of the EZStruder as shown below.



1" feed through.

In MatterControl, click the **LOAD FILAMENT** item in the queue to make it the active job and click **Print**.

The Eris® will begin to heat the hot end up to operating temperature and it will then finish feeding filament in and prime the hot end.

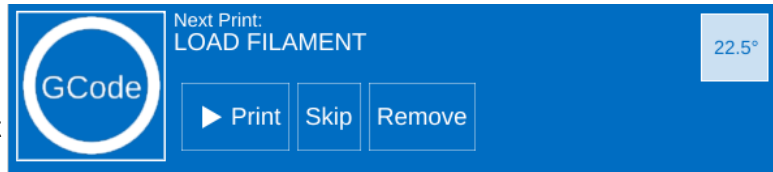

You can tell the Eris® hot end is active by looking for the red LED on the effector PCB as shown below.

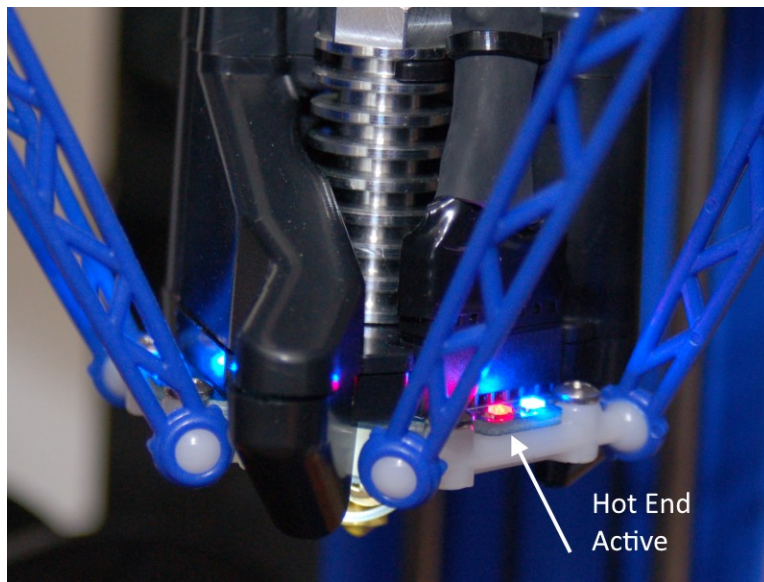

Unloading filament is just as easy – go to the queue and choose the **Unload Filament** item and hit **Print!** The Eris® will bring the hot end up to operating temperature and then rapidly back the filament out of the system.

5 – First Print!

Since MatterHackers was kind enough to supply us with a small calibration cube, let's make that the first print!

Before your first print, make sure that the build surface is clean and free from finger prints. The oils in your fingers can cause prints to not stick sometimes. The easiest way to clean the Eris® build surface is with either soap & water (rinse well!) or with a small alcohol wipe – these are perfect for getting finger marks cleaned off!

Because we've already loaded the Eris® defaults, all you'll need to do is click on the object (**Calibration – Box**) and then click **Print** to begin the print job.

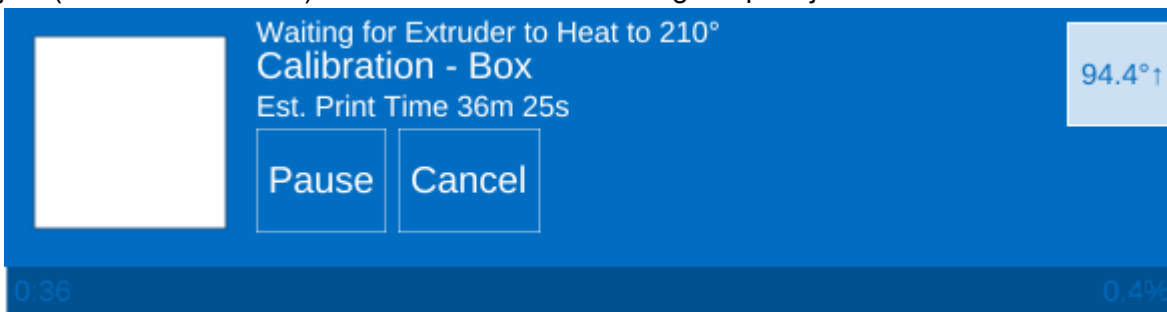

With the print job started, you'll notice that the hot end temperature is increasing and there's a tiny up-arrow indicating that the hot end is active and is heating. When the set temperature is reached, the little arrow will go away.

The display will also give you an estimate of the time it will take for the print to finish. Sometimes the estimate is a ball park, sometimes it's a national park.

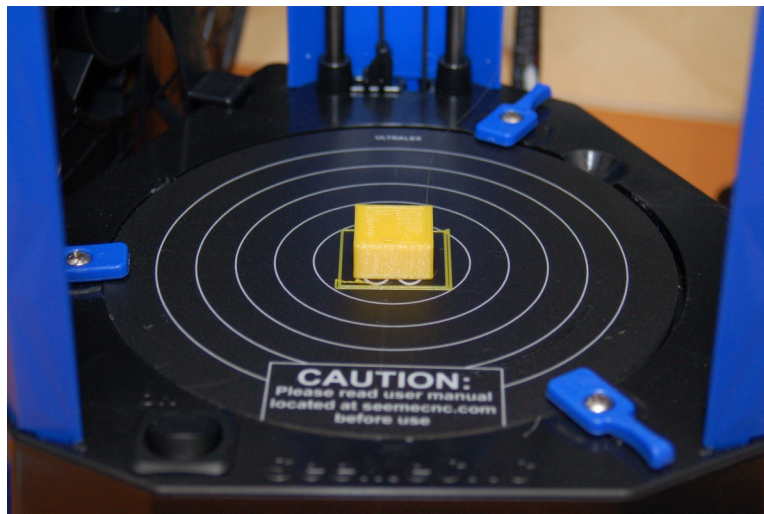

Congratulations on the first print from your new Eris®!

6 – MatterControl Basics: Slicing

MatterControl is a very complete 3D printing package and it's got a LOT of options. Some people can find this intimidating, but I assure you – there's nothing to be worried about!

MatterControl is an integrated host application. This means that it provides everything needed to control the Eris® and to prepare models for printing. The task of preparing a model for printing is called “slicing”. It's a very descriptive term for what is actually happening. In order to print a 3D model, it needs to be converted from a solid object into a series of very thin layers that are in turn converted into G-code (special instructions that tell the printer how to move). For example, if your print layer height is 0.2mm, the slicing tool is going to “slice” your model into a number of layers – basically the model height divided by 0.2mm. For a tall part, this can mean a LOT of layers!

MatterControl provides three slicers for your use. MatterSlice, CuraEngine, and Slic3r. This guide will only cover the specifics of MatterSlice, but don't let that stop you from experimenting with and using the other slicers! I'll show you how to change the slicing engine later on in this guide.

The final task of the slicer is to translate the sliced layers of model into something called G-code. G-code is a simple control language that's used to position the print head and tell the extruder how much plastic to deliver and at what rate. Going into the details of G-code is beyond the scope of this guide, but if you'd like to learn more you can check out the following resources: <http://en.wikipedia.org/wiki/G-code> and <http://reprap.org/wiki/G-code>.

For the most part, you'll never directly interact with G-code, but it's nice to know what's going on behind the curtain!

I want you to click on the **Settings & Controls** button to bring up the **Settings, Controls, and Options** pane.



Click on the **SETTINGS** link to make sure your display follows (by and large) what you see below.

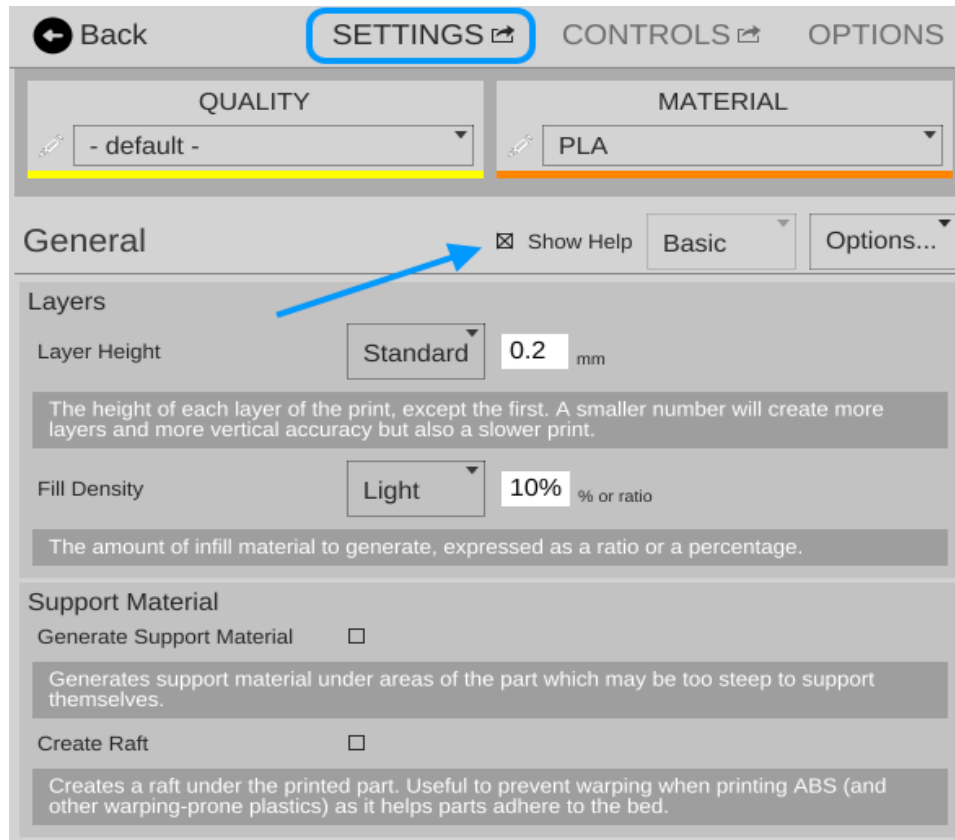

The first thing I want you to do is click on the **Show Help** check box that's highlighted by the arrow in the image above. This will turn on verbose descriptions of each one of the parameters available in the Settings page.

I'm going to only cover the "Simple" configuration settings for right now. There's a LOT that goes on to configuring your slicer and the Simple configuration setting allows many of those to be hidden until you're more comfortable with how your printer works.

Layer Height – This parameter tells the slicing engine how thin to make the layers when it slices up the model as I described earlier. A good default layer height is 0.2 or 0.25mm. The lowest practical layer height with a 0.5mm nozzle is 0.1mm. You can go lower than that, but it requires a smaller nozzle diameter. You can also get a lot thicker, but that requires a larger nozzle. If you change the Quality from **Standard** to **Coarse** or **Fine**, you'll notice how the layer height changes.

Here's what the **Coarse**, **Standard**, and **Fine** layer heights look like when printing the little test cube.

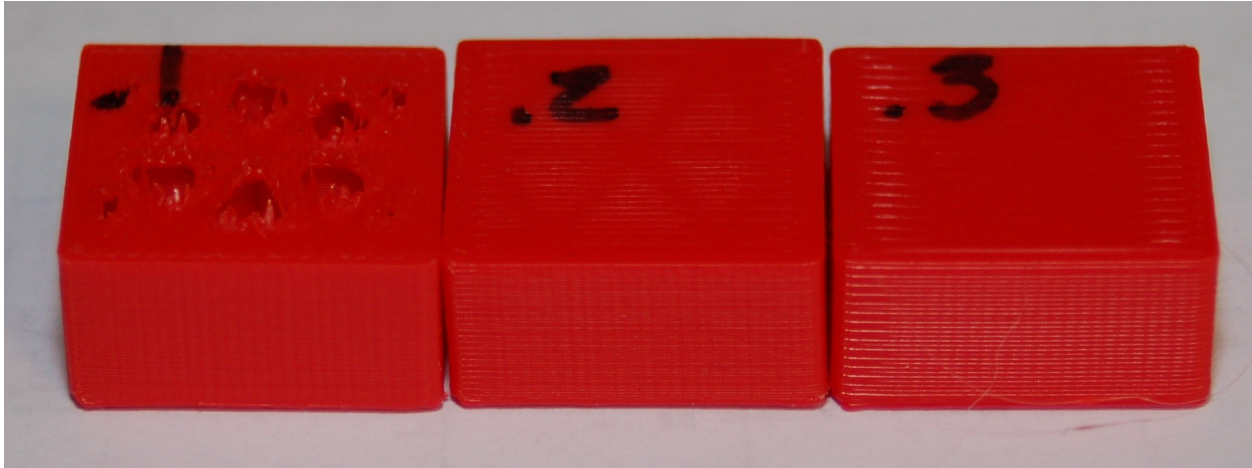

Starting from left to right, the layer heights are 0.1mm, 0.2mm and 0.3mm. You'll notice that the top layer on the 0.1mm print is kind of ratty and torn up. This is because the number of top layers is set to 3. This is perfectly ok with thicker layer heights, but it should have been set to at least 5 for the 0.1mm layer height that the **Fine** setting uses. You'll learn how to tweak that in a little bit.

You can see how the smoothness of the sides decrease as the layer thickness increases. If you want to print something really quick, you could go up to a 0.35mm layer height. I wouldn't recommend anything over 0.40mm if you're using a 0.5mm nozzle however.

Fill Density – This parameter controls how solid your printed part is. The number is a percentage, from 0 (totally hollow) to 1 (totally solid). The default fill density (also known as “infill”) is 0.2 or 20%. The image below shows what that looks like inside our little test cube.

You can tweak the infill to get a more robust or a lighter part. For most prints, 20% is a good infill value.

The **Fill Density** option also allows you to choose one of three preset values. **Light** sets the infill to 10%, **Standard** to 30%, and **Heavy** to 90%.

Later on I'll show you how to change to a different infill pattern. The one shown on the right is the Triangle pattern.

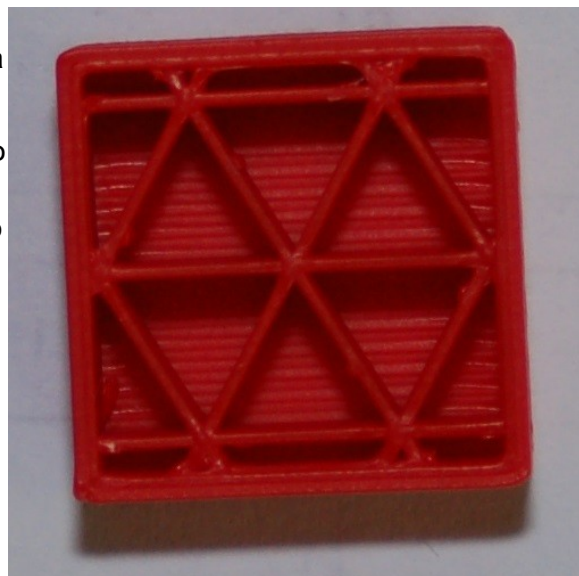

Support Material – Support material is used when the part you're printing has free-standing features (like the chin on a bust) or another feature that requires it to be physically supported during the printing process. When you check the **Support Material** box, the slicer will automatically design support for the part that's currently (or will be) loaded.

Create Raft – A raft is essentially what it says, a “raft” of material that your part will print on top of. Rafts are most often used when printing a part that is having bed adhesion problems due to its geometry. For example, if you're printing a part that sits on small feet, a raft would come in handy if the initial layers of the feet don't stick very well.

In the image below, you'll see an example of both support material and a raft.

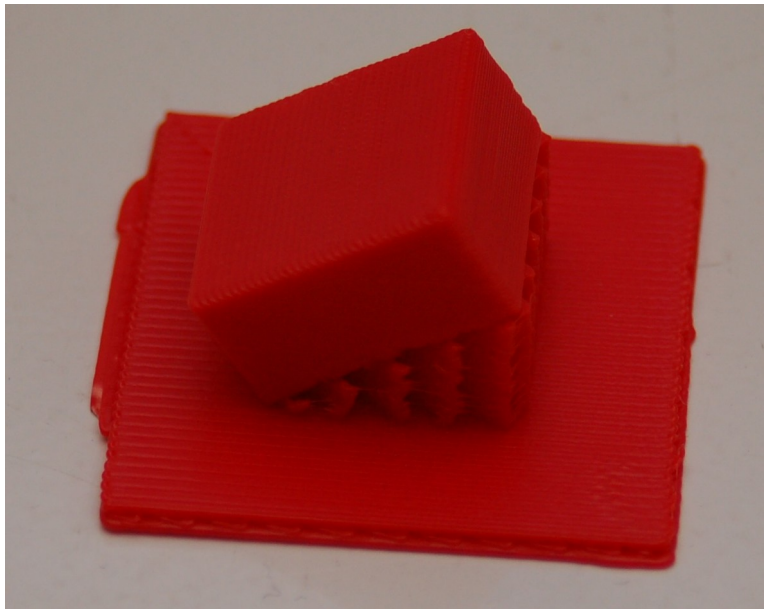

I took the little test cube and through a little manipulation, printed it tilted at 30 degrees. I took this opportunity to also demonstrate what a raft looks like. This one is exaggerated in its size, but gives a great example of what a typical raft will look like.

The image to the right should give you a pretty good idea of what the part looks like from the side. You can easily see the support material as well as the layer lines that will be at a 30 degree angle when the little cube is laid flat.

Support material is generated in such a way that there is just enough of it there to handle the actual print layer that it will be supporting. In my example, the support material has a 2.5mm spacing between the walls of support material and it uses an infill angle of 45 degrees.

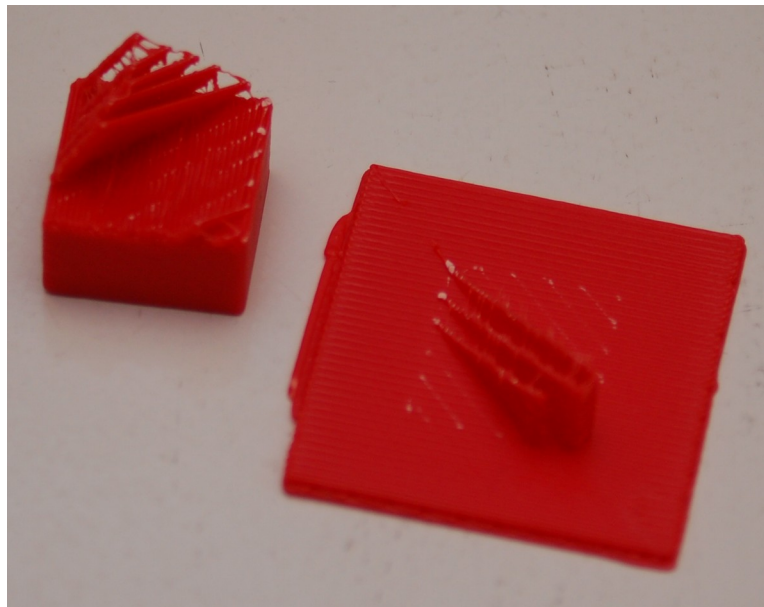
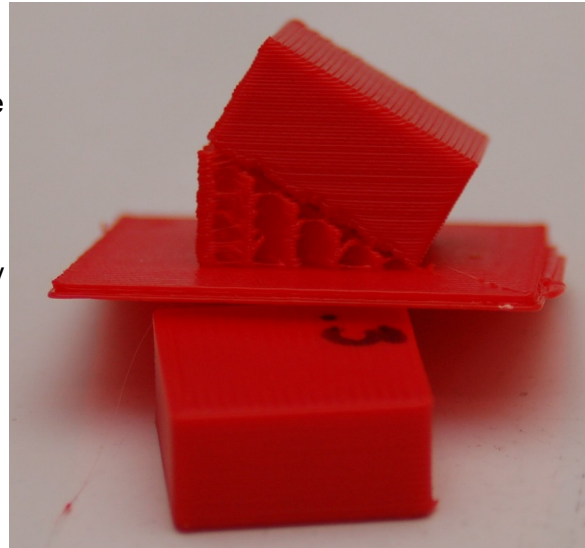

The printed part will usually separate from the support material fairly easily – however, some material will be left behind if you're using a raft. Cleaning up the left over support material is a simple and straightforward task.

Here's what you end up with after removing the support material from your part. As you can see, there's still a little clean up to to be done to the printed cube (on the left). A quick hit with some 220 grit sandpaper will knock the rough edges of the support material down.

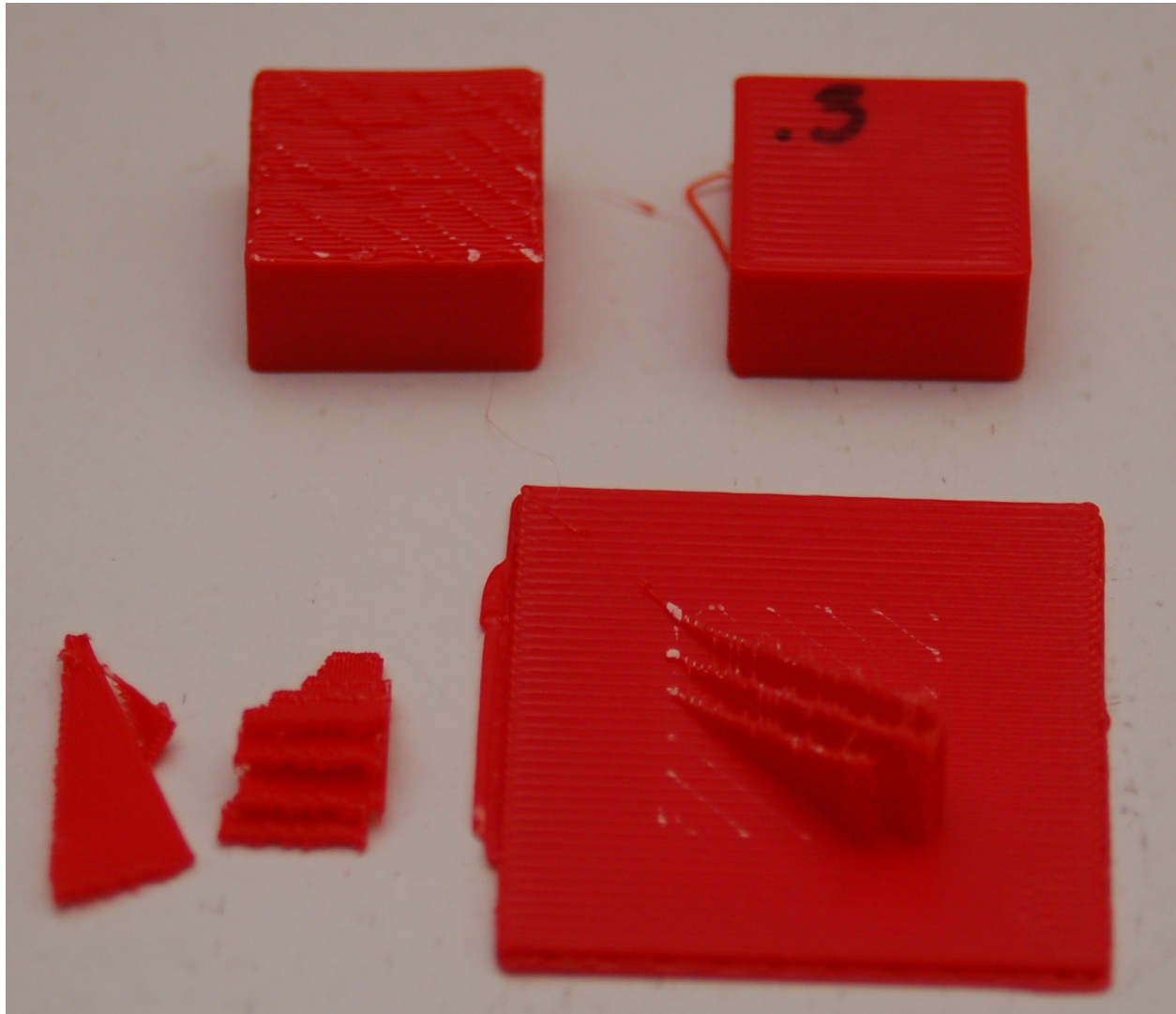

That's pretty much all there is to the **Simple** settings level. Next, let's dig into the **Standard** setting!

Click on the **Simple** setting drop down and pick **Standard**. Your MatterControl settings screen should change to something resembling the image below.

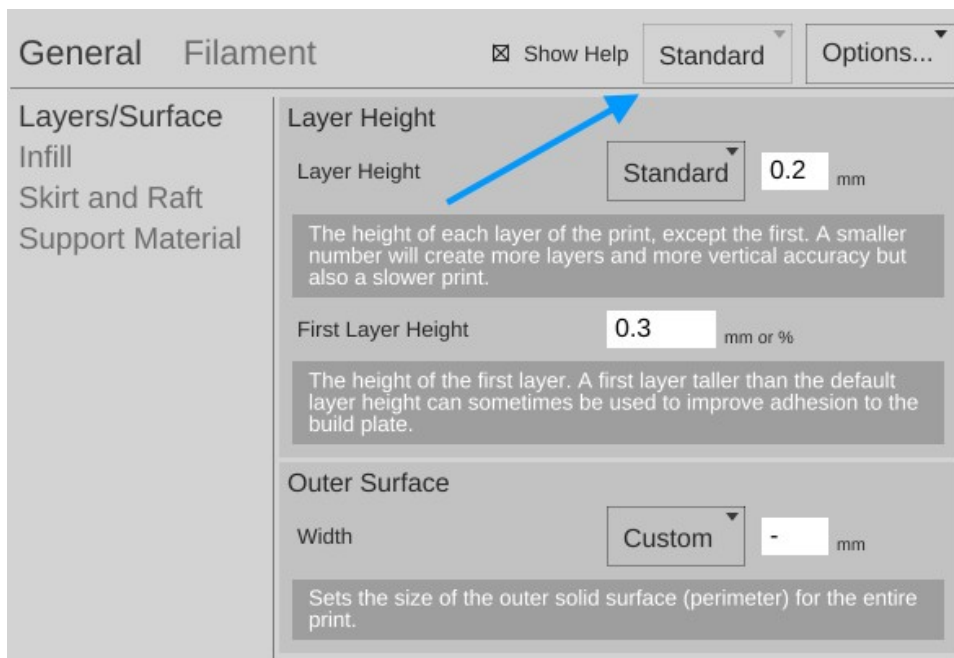

Quite a number of new configuration options are accessible under the **Standard** settings level. The first set of options we'll tackle live under the **General** heading.

Layers/Surface – This setting page allows you tweak the layer height just as before when in **Simple** mode, but now adds the **First Layer Height** and **Outer Surface** settings.

The default **First Layer Height** is 0.3mm. This will create a good first layer when using the 0.5mm that comes with your Eris®. The thicker layer provides more surface area for the follow on layers to adhere to.

The **Outer Surface** setting allows you to specify how thick the “skin” of your printed part will be. The default setting will result in a skin thickness that is roughly 1mm. This translates as two “perimeters” in the part – the hot end will travel around the perimeter of the part twice, as it prints the outer surface of the part.

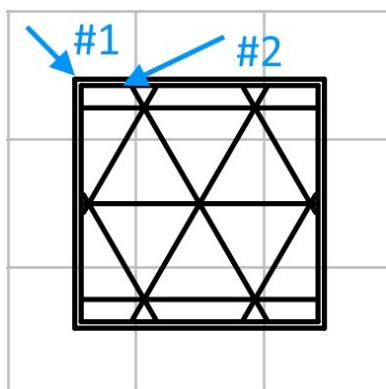

On the left is an example of what two perimeters look like. When the cube is being printed, the #2 perimeter is printed first and then the #1 perimeter. (The order is configurable.)

In the image below you can see what those perimeters actually look like on the example cube I printed.

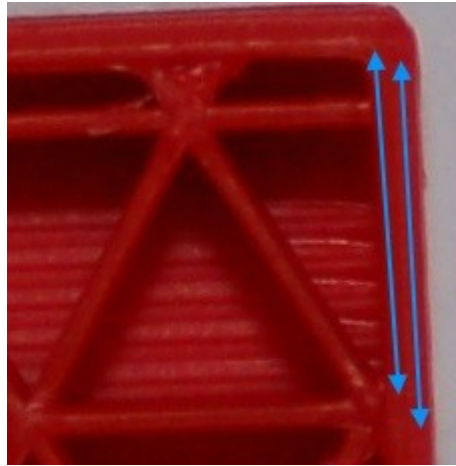

Infill - The **Standard** level adds **Infill Type** in addition to the **Fill Density** figure we covered before. The infill types available are **Triangles**, **Concentric**, **Grid**, and **Lines**. Examples are shown below.

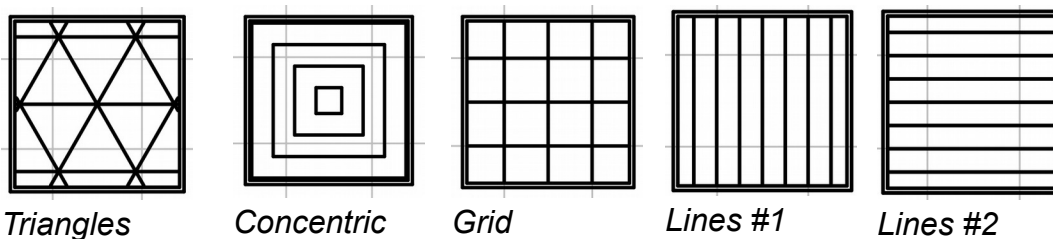

The **Lines** infill pattern differ from the others in that the line orientation is alternated every other layer. All the examples show a 20% infill density.

You're probably wondering which infill pattern is "best". I wish I could go into that, but I've been unable to locate any studies that cover the topic in any depth. If I were asked to provide a recommendation for a good structural pattern I would probably pick the **Triangles** option. It offers a good internal structure for most infill densities that I've used it with.

Skirt and Raft – This is a new option that appears with the **Standard** and **Advanced** setting levels. The **Skirt** option is used one of two ways. First, it can be used to "prime" the hot end with filament before the actual part itself begins to print. You may notice that your hot end may "drool" filament while the bed is heating up and the hot end has already reached temperature. This is perfectly normal. However, without some kind of priming action, early features of your part may not print properly. The **Skirt** solves this. Secondly, the **Skirt** can become a "brim" if the **Distance from Object** setting is set to zero. What this does is make sure that the skirt is physically connects to the part, becoming a brim.

This can be handy when you're printing a small part and you're having bed adhesion issues and you don't want to have to use a raft. Later on in the **Advanced** settings section, you'll see more options on how you can tweak the **Skirt and Brim** settings.

Support Material – With the **Standard** and **Advanced** setting levels, you get more control over how the support material for your part is generated.

The new option here is called **Support Type** and allows you to choose a **LINES** or **GRID** pattern for the support material. When I printed the support example, I used the **LINES** mode as that is the default for the **Simple** settings mode. Looking down on it from above, this is what the **LINES** support material pattern looked like for that print.

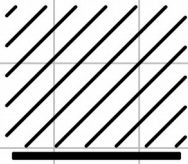
 This shows the second layer of the print. The lines will continue to stack upon one another for the entirety of the support structure.

The **GRID** pattern (on the right) uses the same spacing as the **LINES** option, but is designed to provide more support where it may help to provide a better end result.

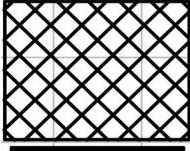

Interface Layers will allow you to specify where to place a solid support layer when the standard support structure isn't enough for the part you're printing.

Normally MatterSlice will only generate support for those elements that can be supported with the support structure starting from the bed surface. If you check **Support Everywhere**, MatterSlice will add support where ever it's needed.

Standard also exposes a new support tuning category called **Support Options**. Here you can adjust the **Pattern Spacing** and **Support Percent**. **Pattern Spacing** controls the distance between support material lines. A wider spacing may create support that's easier to remove, but may not support as well as a narrower spacing.

Support Percent controls when support will be generated. Most slicing software will allow you to define an overhang angle that must be reached before support will be generated. MatterSlice looks at it a bit differently. **Support Percent** basically instructs MatterSlice that; "If the next layer path covers n% or less, you should generate support underneath it."

Here's a visual example that will help you understand what's going on.

The layer stack on the right is angled at 45 degrees. You'll notice that each layer only overlays the layer below it by around 25%. With a **Support Percent** value set to 50%, this would cause support to be generated.

Extruders/Support Material Extruder tells the slicer which extruder to use when generating support. This option is only really meaningful if you're using two extruders and have one dedicated to a special filament meant for support structures (such as PVA).

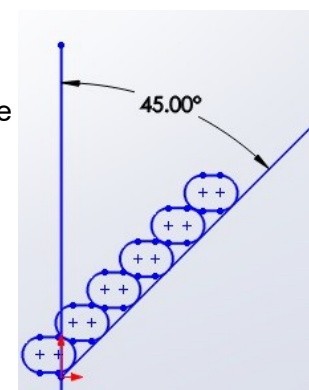

The next new category exposed under **General** by the **Standard** setting is called **Filament**. Under the **Standard** setting, the only option is **Filament**. This allows you to set three parameters that deal directly with the material you're currently using to print with.

Diameter – This is the diameter of the filament you're using. The more accurate this figure is, the better the quality of your prints. This is because the slicer uses the filament diameter to help calculate the optimum flow rate for the extruder during the print.

In order to get an accurate filament diameter, spool off a meter or so of filament and check it in 10 spots along the length of the material. Record the measurements using a digital micrometer and average the results. That average should go into the **Diameter** field.

Extruder Temperature – This figure determines the target temperature of the hot end for the material you're printing with. A typical heat range for ABS is 220 to 240C and 190 to 220C for PLA. Other materials will have their own recommended temperature ranges. **The maximum operating temperature for the Eris® hot end is 240C.**

Extruder Wipe Temperature – this parameter is only applicable to printers that have a special wipe mechanism and shouldn't be used with the Eris®.

Bed Temperature – Like the **Extruder Temperature** the bed temperature is material-dependent. For ABS, a typical heated bed temperature range is between 80 and 100C. For PLA a heated bed isn't required. Note that the **Bed Temperature** parameter may not appear unless you've indicated to MatterControl that you've got a heated bed installed.

The **Retraction** group includes **Length on Move**, **Speed**, **Z Lift**, and **Wipe After Retract**. These items control how the slicer deals with filament retraction. Retraction is used to help minimize or eliminate “stringing” during a print.

Length on Move specifies the distance the filament will be retracted from the hot end during a rapid or “non-printing” movement takes place.

Speed controls the rate at which the filament is retracted and re-extruded.

Z Lift controls the height at which the hot end is lifted after a retract, but before a rapid move is started. This helps to eliminate stringing.

Wipe After Retract – if checked, will cause the nozzle to retrace up to 10mm of the last move after retracting. This is also an anti-stringing measure.

Each filament can have different heating requirements, even within the same type and color! For example, it's not unusual to have two rolls of identical material require different hot end settings. Bed temperatures tend to be less variable. When you're working with a new roll of filament, I recommend printing a test object or two in order to find out what the best temperature setting works best with that material. Note the settings on the spool label, or add your own. This presents a nice opportunity to explain another feature of MatterControl – material profiles! You'll notice a little pencil icon next to the material drop down

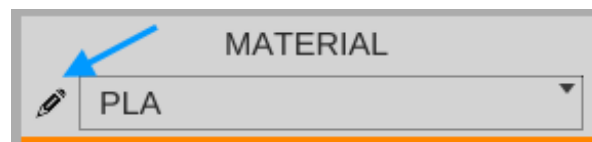

Click on that to open the preset manager.

The **Material Presets** list shows you what pre-configured material settings you've got available to you. When you get a new roll of filament in, you can easily keep track of its settings by using this system. Click on the **Add** button and we'll create your first custom material!

When you click on the **Add** button, you'll be presented with a screen that looks something like the one shown below. The **Edit Preset:** field is where you can name this new material configuration. In this example, I've named it after the vendor, the material color and the

date I purchased the material. Since this is the first time I've used this material, the only thing I know for sure is what the average filament diameter is. To enter that, I picked **Filament** from the **Select Category** drop down, then from the **Select Group** drop down, **Filament** was chosen again and finally **Diameter** was selected from the **Select Setting** drop down. I entered the diameter that I calculated using the process outlined earlier.

The default for the Eris® to print PLA is 210C, so I'll set that as well in this profile. It can always be changed later if it's found to be too hot or too cold.

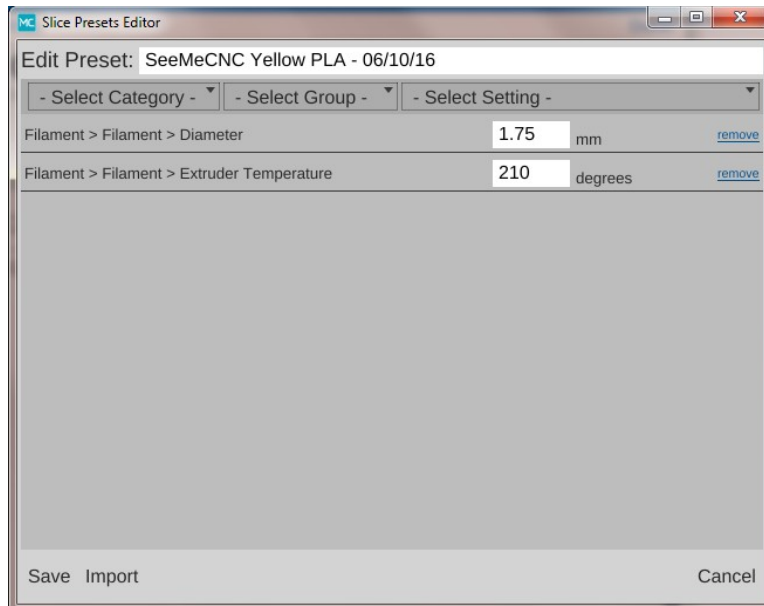
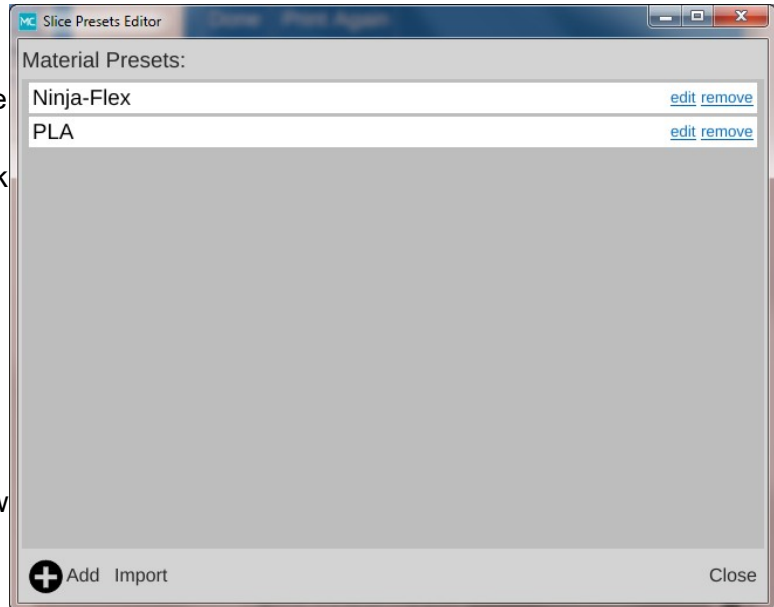

Click on the **Save** button to commit your changes. Congrats, you've added your first custom material profile!

After you've saved your new profile, it will appear as the currently selected material as shown to the right.

Now say you've printed a test cube and have decided that the print might look better if you bumped up the temperature 2 degrees. This is a simple change to make. If you hover your mouse over the **Extruder Temperature** option, you'll see that the foreground is covered by an **EDIT PRESET** button as shown below.

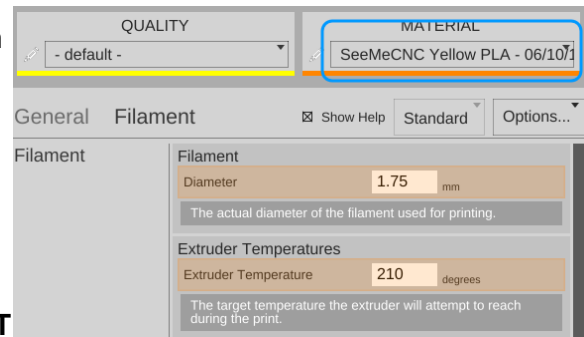

Clicking on the button will open up the materials editor and allow you to change the temperature. It's as simple as that!

Before we move on to the next topic, I wanted to cover one more item – the **QUALITY** presets. I'm not going to go in depth on this one except to note that both the **QUALITY** and **MATERIAL** presets can store identical settings. They're split into two categories in order to make it easier for you to group common settings together. You will typically store things that directly affect the print quality of your model in the **QUALITY** presets. Things like layer height, print speed, etc. **MATERIAL** presets should only contain those settings that directly deal with the material you're using to print the current object with. You'll find that both the **QUALITY** and **MATERIAL** presets contain more options than I've covered here. Those new options are exposed by choosing the **Advanced** settings level. I'll be reviewing those with you later on.

We've covered both the **Simple** and **Standard** settings for the slicing engine. **Advanced** is something I'll cover later, so let's move on to the **CONTROLS** section.

The **CONTROLS** page is where you can manually control your Eris® 3D printer. You can heat the hot end or bed, as well as manually position the effector platform and extrude plastic.

The **Temperature** pane contains everything you need to manually control the temperatures for both the hot end and the heated bed. MatterControl provides room for up to three temperature presets. You can edit them by clicking the pencil icon next to the **Extruder Temperature** label. Creating a temperature preset will create a new button that will be aligned with the pre-existing **OFF** and **PRESET** buttons. You can also enter in a temperature and heat to that value by clicking on the **SET** button that will appear as soon as you begin typing.

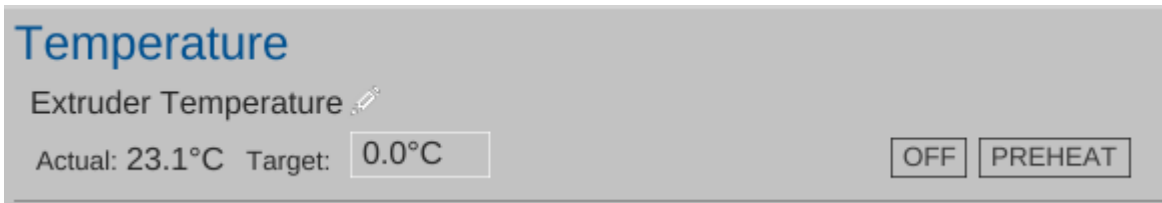

The **Movement Controls** pane contains controls that will allow you to manually position the Eris®'s effector platform.

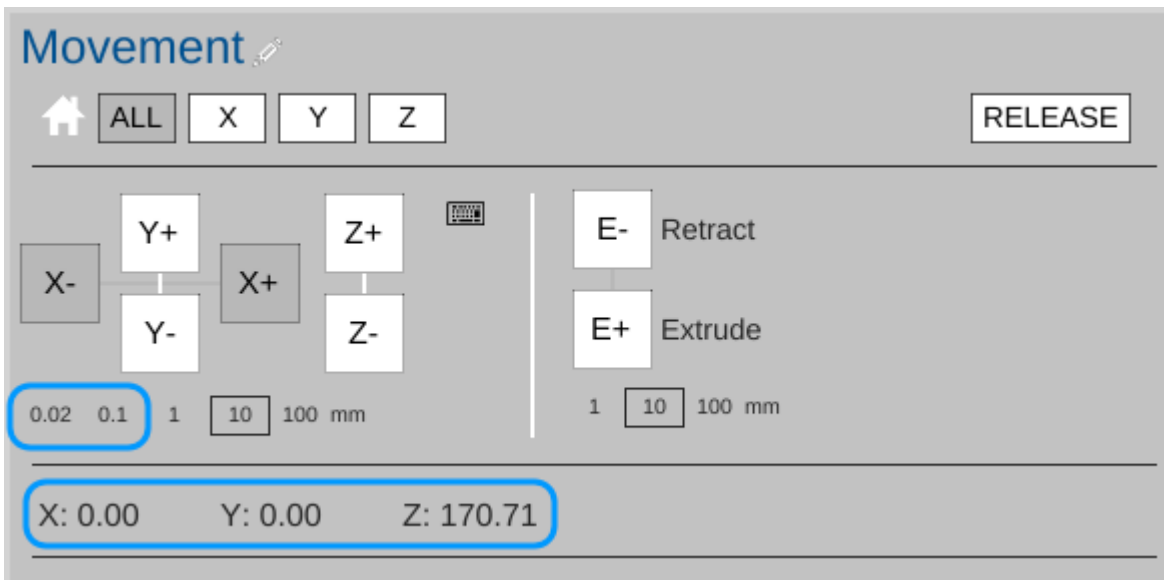

The row of buttons to the right of the little house icon control “homing” of the movement axes in the Eris®. Because the Eris® is a delta configuration printer, the only buttons active are the **ALL** and **Z** buttons – they perform the same action. Connect your printer if you haven't already and click on one of them to see what I mean. The printer will home itself and await further instructions. (Good robot! Have a Scooby Snack!) The **RELEASE** button will tell the Eris® to power down the stepper motors so that the motion axes and extruder can be moved by hand. This is handy when you want to load new filament into the printer without having to turn it off first.

The axis motion is controlled by the X, Y and Z labeled + and – buttons shown above. Below those four buttons are selectors indicating the step distance from 0.02mm to 100mm. The selected axis will move the selected step distance with each mouse click. For this reason, please take special care when you've got 100mm set for the step distance. The Eris® is smart, but not THAT smart. It relies upon you to not put the poor thing in an unlikely position. :)

The “0.02” and “0.1” distance options can come in handy when you first start a print. If you notice that your first layer is either too high or too low, you can use one of these two distance presets to “bump” the Z axis higher or lower by a tiny amount.

The other highlighted items show the current locations of the three motion axes on the Eris®. The X and Y axes show as being in their “home” position, which is the center of the bed at 0,0. The Z axis describes the height of the hot end and it's at its home position of 170mm or so.

The last set of buttons control the extruder motor – they're marked **E-** and **E+** and can be used to manually extrude filament. Note that they will only work if the hot end is up to operating temperature! The amount of filament extruded (or retracted) is set using the step selector below the control buttons for the extruder.

7 – MatterControl Basics: Loading & Printing an Object

We've previously worked with the small cube that MatterControl provided as an example. Now we're going to cover loading and slicing an object from start to finish.

For this section, I recommend you head over to <http://www.repables.com> and find something you'd like to print. I'm going to chose the SeeMeCNC "Blinky" logo token (<http://www.repables.com/r/118/>) for my example print. You don't have to make the same choice, but pick something geometrically "simple" in order to make the learning process a bit easier.

Most (if not all) 3D printer slicing programs can read a file format called "STL". (You can learn more about this file format, including its origins, here: http://en.wikipedia.org/wiki/STL_%28file_format%29) When you download a file from Repables or one of the other free, online object repositories, you'll often get the file as a zip file. One nice feature of MatterControl is the ability to select a zip file and MatterControl will transparently extract all the files it knows how to read and load them up into your print queue.

To load a file into MatterControl, make sure you're on the **Queue** page and click the **Add** button at the bottom right hand corner of the window.

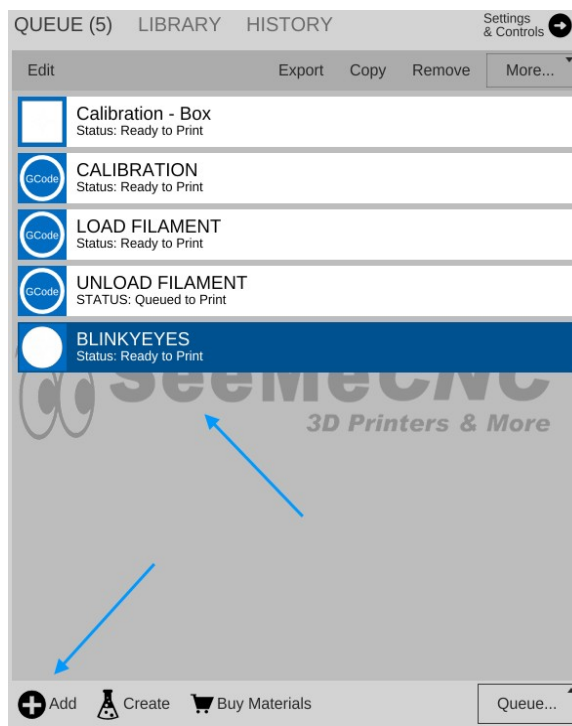

Navigate to where you've stored the STL or ZIP file and open it using the Open File dialog that will appear.

I chose the Blinky Eyes token because it's got an odd little characteristic. The model was saved using centimeters as the unit of measure instead of millimeters. This results in a model that appears to be 10 times smaller than it really is!

This provides the opportunity to use MatterControl's model scaling feature. As you can see below, the loaded model is very, very, tiny!

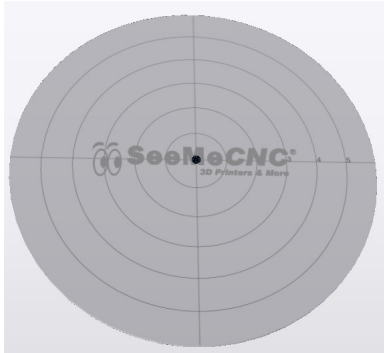

Yep, that tiny little dot in the center of the build area is the model I just loaded. Fortunately, this is a really easy fix.

Click on the **Edit** button that's located at the bottom of the model view pane.



That will activate the model editor so we can adjust the scale of the object.

Tiny Blinky Eyes!

The various edit tools are on the right edge of the model view pane. Click the **Scale** button and enter "10" in the **Ratio** field. Click the **Apply Scale** button to make the change.

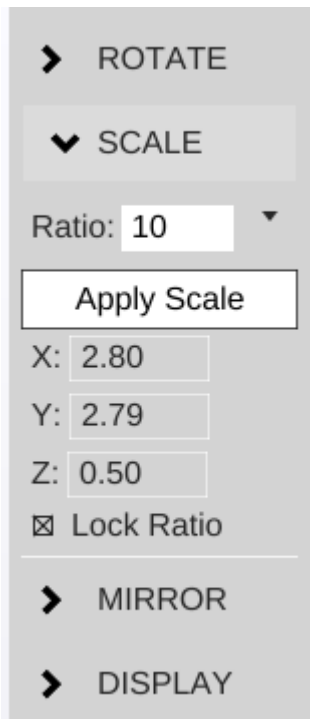

Once the scale has been changed, your Blinky Eyes token should appear the same as the one shown below. Click the **Save** button at the lower right hand corner of the model pane to save your changes.

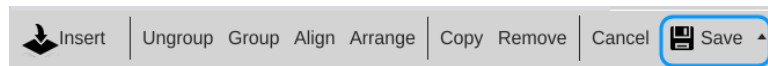
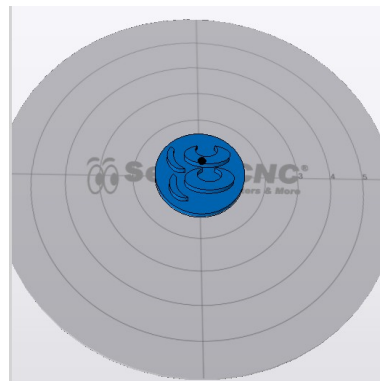

Save those changes!

You can then click the **Cancel** button to exit the editor.

Now that you've gotten the scaling adjusted, click on the **Settings & Controls** button so we can make sure you're using the right profile to print this object.

Click the **Settings** button and make sure that the **Quality** box is set to "Standard" and the **Material** box is set to the material preset you created earlier.



Before we start this print, let's take a second to examine a feature of MatterControl – the **Layer View**. If you've not sliced this object yet, you'll like see the text "Press 'generate' to view layers". Go ahead and do that now.

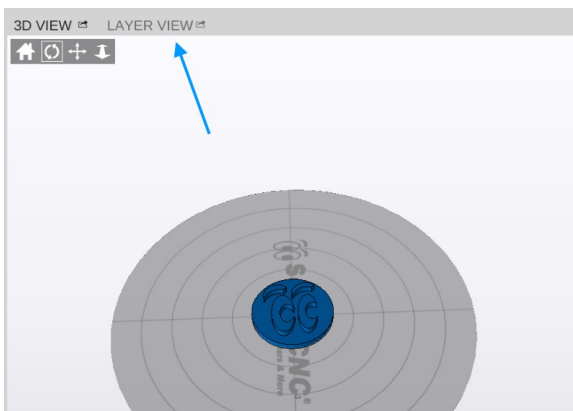

When the slicing process finishes, you'll be presented with a display that shows you what the first layer of your object is going to look like.

When it finishes, the layer view will display the first layer of your print job.

You'll notice right off the skirt that I covered previously. It's important to make sure that the hot end is primed by the time it begins to print your part!

At the bottom of the window you'll see some controls that will allow you to either re-slice the object (**Generate**) or view the individual print layers.

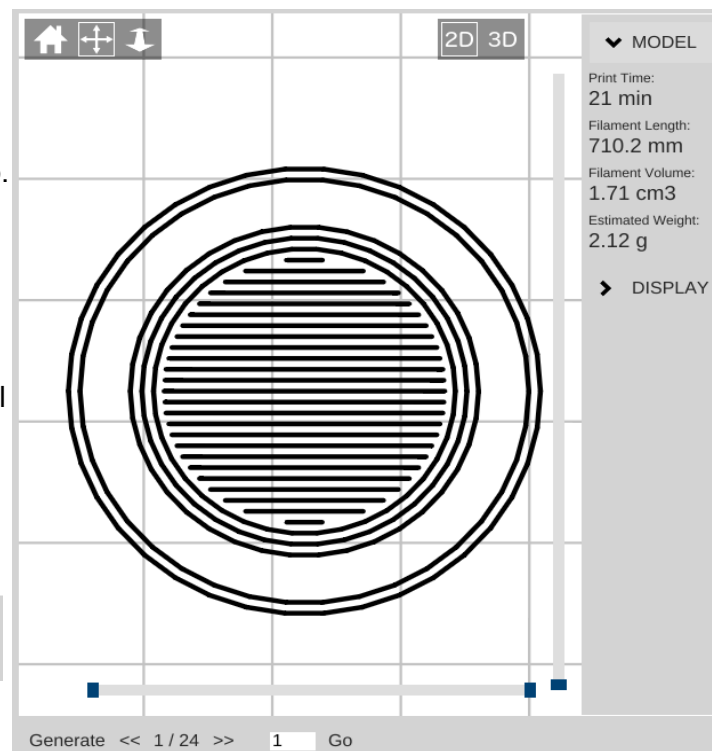

The controls will show you how many layers are on this object as well as what the layer number is that you're currently viewing. You can navigate forward and backward through the layers by using the >> and << buttons. If you want to jump to a specific layer, you can enter it in to the box and click **Go**.

After slicing the object, MatterControl will display a few statistics about the current print in the Layer View window. This can be handy information if you're selling your services and need to know how much a particular part is going to consume in both time and materials.

Go ahead and click the **Print** button and get your object printing!

▼ MODEL

Print Time:
21 min

Filament Length:
710.2 mm

Filament Volume:
1.71 cm³

Estimated Weight:
2.12 g

Once the print job finishes, you should have a little Blinky Eyes token that looks like the photo below.



8 – Advanced MatterControl: Options

MatterControl includes a number of basic configuration options that you can use to set up things like your default slicing engine, change EEPROM settings, etc.

Let's go over each one as they appear on the MatterControl **Options** pane.

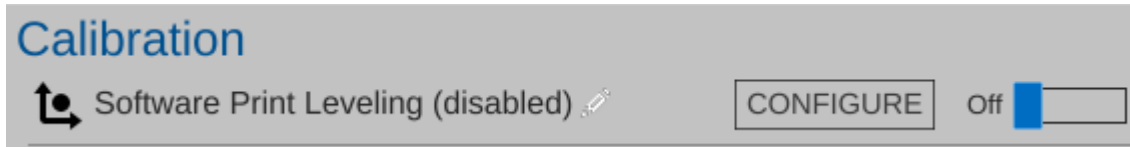

MatterControl includes a bed leveling feature that when properly configured, can assist with issues that can arise from an unlevel bed. I include this feature for completeness – since your Eris® has its own hardware calibration system, the one included in MatterControl is never used. In fact, unless you tell MatterControl that you *don't* have “hardware leveling”, you won't even see this option.



The EEPROM Settings configuration option will allow you to edit firmware parameters that are stored on the controller inside your Eris®. Please take special care when changing EEPROM values. An improperly set configuration parameter can cause your Eris® to misbehave. Sometimes rather dramatically. (One user reported something about his Eris® chasing the cat and yelling something about a “Smurf invasion”, but we haven't been able to corroborate that.)

Here's an example of the things you can change under the EEPROM Settings configuration:

Two fields you might be interested in are “Filament printed” and “Printer active”. As you can see from the display, the Eris® used here has printed 25.44 meters of filament for a total active time of 36,959 seconds (or roughly 10 and a half hours).



Description	Value
Baudrate	250000
Advanced User	1
Filament printed [m]	25.44
Printer active [s]	36959
Max. inactive time [ms,0=off]	900000
Stop stepper after inactivity [ms,0=off]	600000
Steps per mm	80
Max. feedrate [mm/s]	125
Homing feedrate [mm/s]	80
Max. jerk [mm/s]	12

Save To EEPROM Import... Export... Close



The Gcode Terminal is where you can directly interact with the firmware on your Eris® 3D printer.

When you first open the Gcode Terminal, you'll be presented with a window that looks similar to the one below:

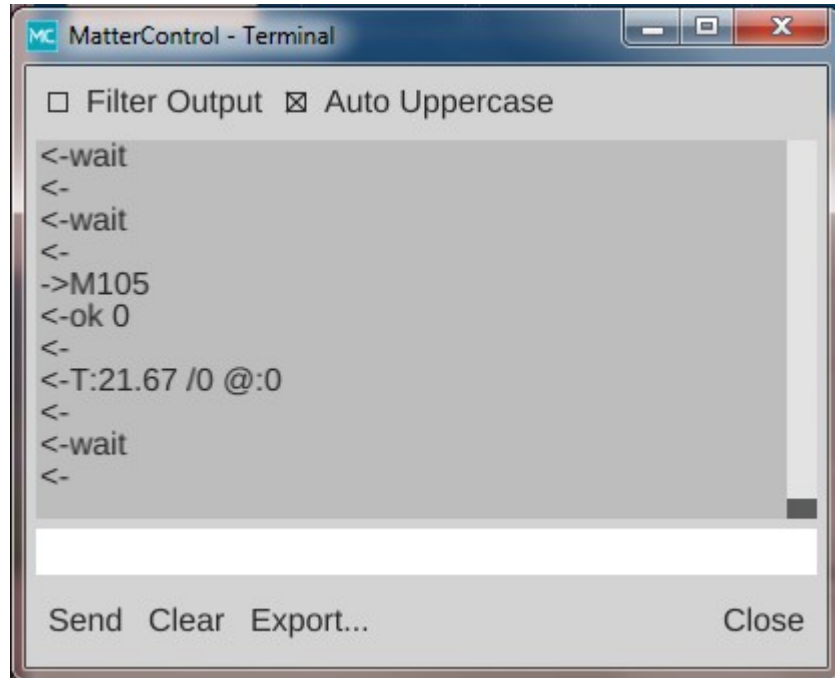

You'll notice that the display will scroll as new information comes in from the Eris®. This is how MatterControl is able to continually update things like the temperature displays. In order to be able to use the terminal for basic tasks, you'll need to click on the **Filter Output** check box that's at the upper left corner of the window. This will filter out the telemetry information coming from the Eris®'s controller and allow you to directly interact with the printer without having the output interleaved with the periodic information that the Eris® transmits.

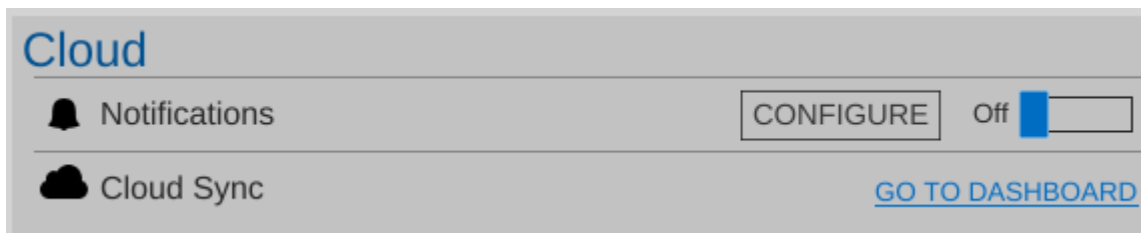

MatterControl provides the ability to remotely submit jobs or monitor your Eris® 3D printer from anywhere in the world. To learn more about the remote control feature, click on the **“GO TO DASHBOARD”** link and your browser will open up the MatterControl Cloud Sync website.

MatterControl also provides a few different settings that control how you can be notified when a print job finishes.

By default, MatterControl will play a bell sound when the current active print job completes. However, you can change this behavior via the **Notification Settings** configuration screen. You'll be able to configure MatterControl to send you an email or text message when your printer completes a job.

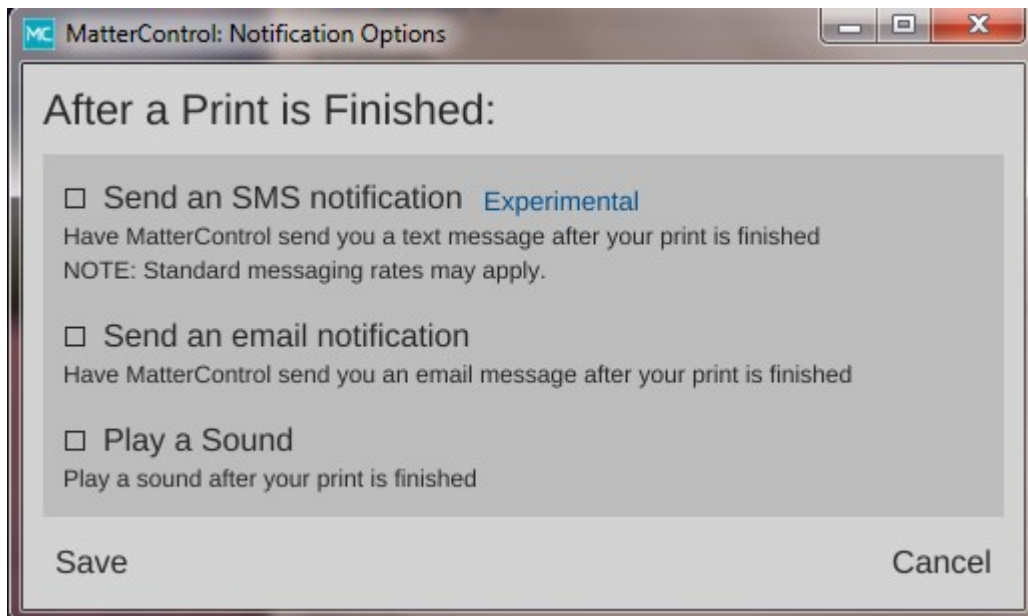

The **Language** setting allows you to change what language MatterControl uses when displaying the user interface.



The **Slice Engine** configuration will allow you to choose which slicer that you want to use in order to prepare your model for printing. By default, MatterControl uses the **MatterSlice** slicing engine that was developed by the MatterControl team. You also have the option of

choosing **Slic3r** or **CuraEngine** to do your slicing. Selecting a different slicing engine will change the options available on the **Settings** pane, but shouldn't disturb those you've changed in the past. The MatterControl team has tried to keep common names across slicing engines, so the most noticeable change you'll see will be additional options supported by one slicer but not the others.



MatterControl offers two kinds of rendering for the thumbnail display that's in the upper left corner of the print window. See below for the two different options as they apply to the Blinky Eyes token you printed earlier:

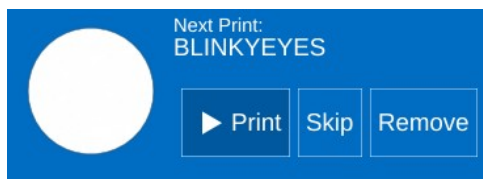

Rendered "flat"

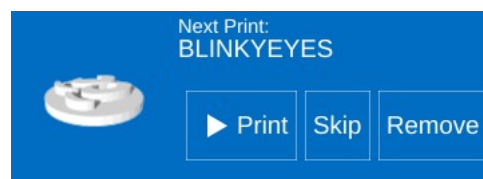

Rendered "3D"



MatterControl supports both the traditional mouse interface as well as a touchscreen interface. **Display Mode** dictates which of the two modes that MatterControl is operating in.



Clear Print History will remove all the items that are currently in your queue display.



Theme allows you to change the primary color that the user interface renders in. The top row of color selections provide the selected color against a light background. The second row of color selections provide the selected color against a dark background.

9 - Advanced MatterControl: Settings - Print

MatterControl offers three “classes” of settings that have a direct effect on how your printer works. **General** covers elements that relate to how the plastic is laid down. **Filament** covers parameters specific to the type of filament that you've chosen to print with. **Printer** handles those remaining parameters that describe the physical printer you're currently using to print with. This section will cover **Print**.

Let's start this overview on the main page of **General, Layers/Surface**.

The screenshot displays the MatterControl software interface. At the top, there are two dropdown menus: 'QUALITY' set to 'Standard' and 'MATERIAL' set to 'SeeMeCNC Yellow PLA - 06/10/1'. Below these are tabs for 'General', 'Filament', and 'Printer', with 'Printer' selected. A 'Show Help' checkbox is checked, and there are 'Advanced' and 'Options...' buttons. The main content area is divided into a left sidebar and a right main panel. The sidebar lists settings categories: 'Layers/Surface', 'Infill', 'Speed', 'Skirt and Raft', 'Support Material', 'Output Options', and 'Multiple Extruders'. The 'Layers/Surface' category is selected. The main panel shows the following settings:

- Layer Height:** A dropdown menu set to 'Standard' and a text input field set to '0.2 mm'. Below it is a description: 'The height of each layer of the print, except the first. A smaller number will create more layers and more vertical accuracy but also a slower print.'
- First Layer Height:** A text input field set to '0.3' with 'mm or %' to its right. Below it is a description: 'The height of the first layer. A first layer taller than the default layer height can sometimes be used to improve adhesion to the build plate.'
- Bottom Clip:** A text input field set to '0' with 'mm' to its right. Below it is a description: 'The amount to remove from the bottom of the model, in millimeters.'
- Select Layer To Pause:** A text input field. Below it is a description: 'If you want to select a layer to pause your print on do so here (for changing filament)'
- Outer Surface - Perimeters:** A text input field set to '3' with 'count or mm' to its right. Below it is a description: 'The number, or total width, of external shells to create. Add mm to the end of the number to specify width in millimeters.'
- Avoid Crossing Perimeters:** A checked checkbox. Below it is a description: 'Attempts to avoid having the perimeter line cross over existing perimeter lines. This can help with oozing or strings.'

The first parameter is **Layer Height**. We've covered this one before, but I wanted to point out something that I didn't go into a lot of detail about earlier. You'll notice that the field has a yellowish highlight to it. That means that the value exists in the currently selected **QUALITY** profile. If you look carefully, you'll see that the highlight color matches the thin colored line under the **QUALITY** drop down. (This same effect holds true for **MATERIAL** profiles, but the color is orange.)

Any time you add a **General** parameter to a preset profile, it will be highlighted just as the **Layer Height** field is in the example. Note that you can use any of the **General**, **Filament**, or **Printer** configuration parameters within either of the **QUALITY** or **MATERIAL** profile editors.

First Layer Height mm or %

The **First Layer Height** parameter allows you to set the thickness of your first layer. Having a thicker first layer will help provide a good base to build the rest of the part on as the thicker (and thus wider extrusion) will help improve the adhesion to the bed. If your first layer isn't any good, the part could eventually separate from the bed and ruin the print job.

Bottom Clip mm

Bottom Clip allows you to tell the slicing engine that you'd like to “clip off” a specific amount from the bottom of the model. For example, say you've got a 200mm tall model, but you only want to print the top 50mm or so. You can enter 150 into the **Bottom Clip** field and when the slicer generates the G-code for the print job, it will begin slicing 150mm up from the bottom of the model.

Select Layer To Pause:

Select Layer To Pause gives you the option of telling MatterControl to pause the print at a specific layer. This is most often used when you want to change to a different color of filament for the current print job. When the print job pauses, MatterControl will lift the nozzle a few millimeters to give you room to purge the old color out of the nozzle when you change filament. You can use the **Layer View** in order more easily decide which layer you'd like to pause on.

Perimeters count or mm

Perimeters dictate how thick the “skin” of your model is. 2 or 3 perimeters are good for most parts, but if you want a really strong exterior wall, you can make the perimeter count as high as you feel you need it. To get an idea of how thick the skin will be, you multiply the perimeter count by the extrusion thickness (we'll get to that parameter in a bit). For example, if you have a 0.5mm nozzle, chances are your extrusion thickness will be set to 0.5. 2 perimeters will give you a skin thickness of 1mm. If you want a very specific skin thickness you can enter a value with “mm” as the suffix (ex. “1.2mm”).

Avoid Crossing Perimeters

When **Avoid Crossing Perimeters** is enabled, the nozzle path will not cross a part perimeter during travel moves. This will help reduce the opportunity for stringing or oozing since the nozzle tip is rarely over open air. For instance, if the tool path would normally cause the nozzle to travel from one side of the part to the other, it would cross at least two perimeters and may leave strings of material in its wake as it moves. If it is set to not cross perimeters, it will cause the nozzle to trace a perimeter back to the nearest point where it can begin printing again instead of jumping straight across to the new extrusion position.

Spiral Vase

Spiral Vase mode allows you to print things like vases or other open top, single-wall objects in one continuous layer. What happens is that instead of the slicer raising the nozzle up a full layer height for each new layer, it gradually increases the Z height as the print progresses. This results in a perfectly seamless object, which can be important for artistic prints such as vases. When you're printing a vase or similar object, you'll want to make sure that you set the top layer count to zero to prevent the vase getting a "lid" that you'll have to cut off.

External Perimeters First

By default, objects are printed from the inside features to the outside. If you want to reverse this process, enable **External Perimeters First**. This will cause the outside of the model to be printed before the interior features.

Top Solid Layers:	<input type="text" value="5"/>	count or mm
Bottom Solid Layers:	<input type="text" value="5"/>	count or mm

The **Top** and **Bottom** solid layer parameters dictate how thick the top and bottom surfaces of your object are when printed. These two parameters fulfill essentially the same function as the **Perimeters** parameter, but for the top and bottom of the part. You can calculate your top & bottom thickness by multiplying the solid layer count by the layer height. For example, 5 top layers will result in a final top thickness of 1mm if your layer height is 0.2mm. You also have the option of specifying an exact thickness in millimeters, using the same "mm" suffix used in the **Perimeter** field.

The next page in **General** is called **Infill** and covers how the interior of your part is filled. While I covered **Fill Density** and **Infill Type** earlier, the **Advanced** mode adds two new parameters.

Starting Angle degrees

The **Starting Angle** parameter allows you to control the orientation of the infill. For example, an infill type of **GRID** with a starting angle of zero degrees is going to look like this:

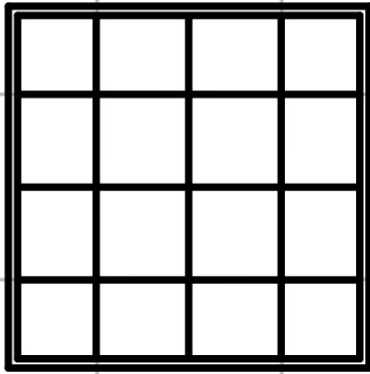

Now if you change the starting angle to 45 degrees, you'll end up with an infill pattern that looks like the example below.

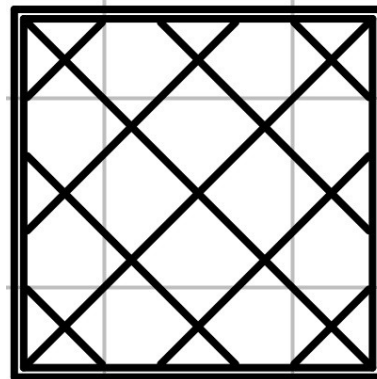

Note that changing the starting angle will also change the angle in which the top and bottom layers are printed. You can see this in the image below – this shows the second layer as it would be printed.

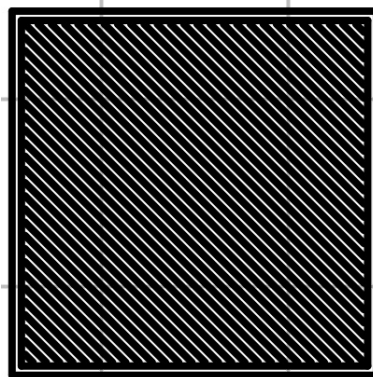

Infill Overlap mm

Infill Overlap is used to adjust how well the infill pattern attaches to the inside perimeter of the part. A good infill will have a solid connection to the inside perimeter of your part, and the structural integrity of your part depends on this.

The **Speed** page covers parameters that control how fast various features of the object are printed. The speeds are listed in mm per second, or as a percentage of a related speed parameter.

The speed parameters are pretty self-explanatory, especially if you've got the **Show Help** check box set. However, there's a couple of points I'd like to cover about printing speed.

First of all, there is a relation between your print speed and the temperature you've set for the material you're printing with. The basic rule is, the faster you go, the hotter you print. This is because as the hot end extrudes plastic, it's constantly being cooled by the cold filament that's coming in.

Setting the extrusion temperature higher allows the hot end to melt the incoming plastic at a faster rate. This allows you to print more quickly. The relation between print speed and extrusion temperature is one of those things you'll get a feel for as you gain experience with your printer.

You'll quickly learn that the Eris® will “talk” to you if you're printing too rapidly for a given temperature. The extruder will begin to “skip” periodically (or frequently, depending on how fast you're going). A skipping extruder has a very distinct sound – it's kind of a light bump or knocking. If you watch the manual feed knob on the extruder, you'll notice that it will briefly rotate in the opposite direction at the same time you hear the skipping sound. The skip is caused by the hot end's inability to melt the material as rapidly as is required. The pressure builds up until the stepper motor can no longer generate the force required. At this point the tension in the filament is released like a spring and the filament pushes back with enough force to cause the stepper motor to skip steps, resulting in a short reverse rotation.

Secondly, there is also a direct relation between print speed and print quality. In the image above, you'll notice that the speeds for print moves vary a bit. This is because some features don't require a focus on surface quality.

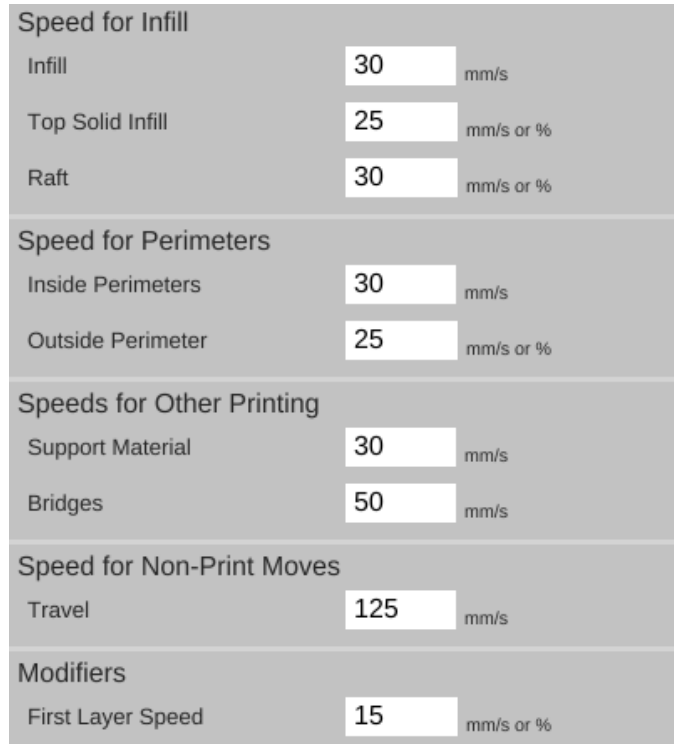

Speed for Infill		
Infill	30	mm/s
Top Solid Infill	25	mm/s or %
Raft	30	mm/s or %
Speed for Perimeters		
Inside Perimeters	30	mm/s
Outside Perimeter	25	mm/s or %
Speeds for Other Printing		
Support Material	30	mm/s
Bridges	50	mm/s
Speed for Non-Print Moves		
Travel	125	mm/s
Modifiers		
First Layer Speed	15	mm/s or %

Perimeters are a great example of this. You'll note that the inside perimeter speed is 40mm/sec, while the outside perimeter is 35mm/sec. The inside perimeter will never be seen after the print is finished so it can be printed at a higher rate. However, you want the visible surface of the print to be smoother and more consistent, so you print the outside perimeters a bit more slowly.

The last bit about speed settings I want to cover is the first layer speed. You'll see that it's *really* slow. The reason for this is that while hot plastic loves to stick to hot plastic, hot plastic doesn't like sticking to other things as much. By going slowly on the first layer, you're giving the material time to get a good grip on the surface of the bed. This is known as "part adhesion". When a part comes unstuck from the bed during a print, it's ruined. This isn't so bad when you're five minutes into a print, but you'll be ready to flip a table when it happens 18 hours into a 19 hour print.

The **Skirt and Raft** page covers settings that control how the hot end is primed at the beginning of a print job as well as features that help the part stick to the bed.

The first section covers the **Skirt** feature. A skirt in this context is basically a series of single-layer loops printed around the perimeter of the part. This acts as a method to "prime" the hot end with material before the actual part begins to print. **Loops** defines how many times you want to go around the print. This is tied to the **Minimum Extrusion Length** parameter. If the number of loops you specify are not enough to meet that minimum length, additional loops will be added automatically.

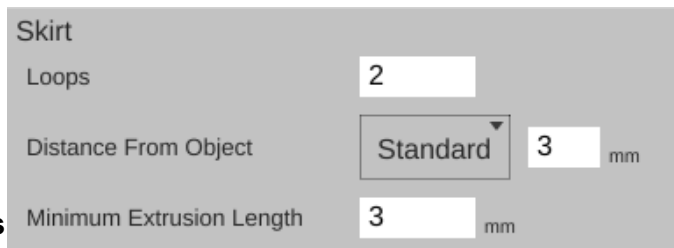

Skirt	
Loops	2
Distance From Object	Standard 3 mm
Minimum Extrusion Length	3 mm

The **Distance from Object** parameter dictates how far away the loop stands off from the part outline. If you set the distance to zero, the skirt will become a "brim". It will result in the loops being printed connected to the first layer of your print. This can give small parts a first layer that has a larger surface area to improve part adhesion. Since the brim is only a single layer thick, it's usually pretty easy to remove after the print job has completed.

I mentioned earlier that hot plastic really loves sticking to hot plastic, but not so much to other things. If a brim isn't doing the job for you, you can try a **Raft**.

When in **Standard** mode, the **Raft** setting was simply an on/off thing. In **Advanced** mode, you've got a lot more control over how the raft is laid down.

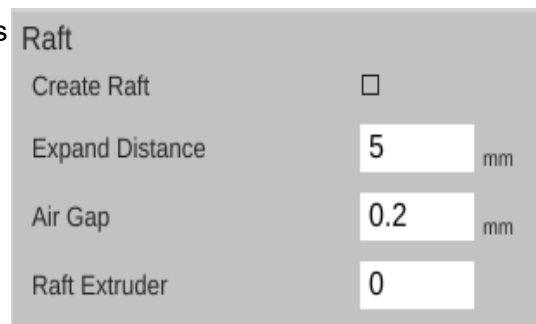

Raft	
Create Raft	<input type="checkbox"/>
Expand Distance	5 mm
Air Gap	0.2 mm
Raft Extruder	0

Expand Distance is the distance you'd like the raft to exceed the base area of the part you're printing. You may want to adjust this parameter if the part you're printing is larger than the bottom contact point on the bed. A larger raft will help to support the part more effectively.

Air Gap defines how much space you want between the top surface of the raft and the bottom surface of your part. This gap helps make it easier (or even possible!) to remove the raft from your part when it's finished. As mentioned in the help text, a good air gap is one half the diameter of the nozzle. For example, if your nozzle is 0.5mm, you'd want an air gap of 0.25mm.

If you've added a second extruder to your Eris®, you can specify which one should be used for rafts by setting the **Raft Extruder** value to the index of the extruder you want to use. If you don't have multiple extruders, you can leave this set to zero.

The **Support Material** page provides detailed settings on the use of support material if the part you're printing requires it. While I covered the basics of support earlier, I'm going to get a bit more in-depth on it here.



Checking **Generate Support Material** will allow you to configure support for your part. Support is required when a part has an overhang or other angled feature that would result in little or no physical support to put a print layer on. The **Support Type** selection allows you to define the geometric pattern for the support structure. You have **GRID** and **LINES**. These patterns were covered earlier, so I won't cover them again here.



Pattern Spacing controls the distance between each “track” of support that is laid down to support your part. The wider the spacing, the less support that is printed.



Support Percent tells the slicing engine that it should generate support for layers that have an overlap of less than the specified percentage. In the setting shown above, the slicing engine will generate support at points where the model layers overlap 50% or less.

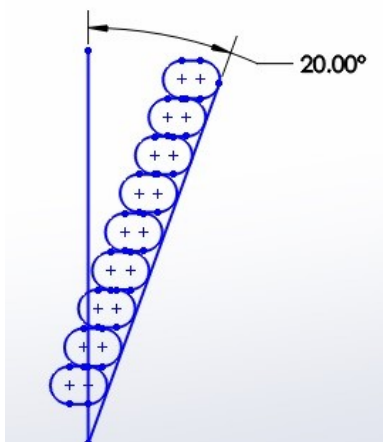

When you've got a part feature that's only 20 degrees or so, each layer can easily be supported by the layer underneath. This is because as the part height increases, the horizontal dimension increase is less than the extrusion width. This means that each new layer has a solid foundation to adhere to as it's being applied. At 20 degrees, you can see the layer overlap is right around 80%.

As you can see when your angle increases to 45 degrees, each layer has much less surface area to adhere to as you print. This is where support comes in handy. It provides that underlying structure for those layers to build upon.

As the angle increases, the underlying surface area for each layer becomes smaller and smaller until there's simply not enough surface for the next layer to adhere to. In these instances, support material is practically a requirement if you want your part to print at all.

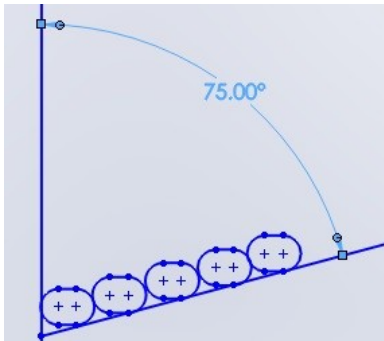
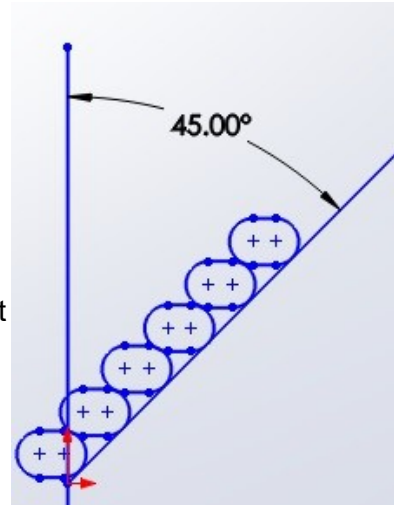

Infill Angle degrees

Infill Angle adjusts the angle at which the support structure is built.

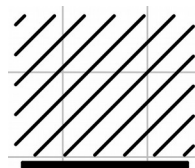

45 Deg. Infill

Interface Layers layers or mm

Interface Layers allows you to specify solid layers interspersed with the support material. This comes in handy when using multiple extruders. For example, if you're printing a part in PLA with lots of support, you can generate all the support with PLA, and then have 5 or 6 interface layers of PVA (a water soluble filament). The print would then only be in contact with the PVA interface layers and it would be a flat layer to print on. When finished you can dissolve away the interface layers and the rest of the support falls off the part cleanly.

X and Y Distance mm

X and Y Distance dictates how far away the support structure will be from the part you're printing. You want it as close as you can get it without it actually touching the surface of the part. The default of 1mm seems to work out pretty well.

Air Gap mm

Air Gap specifies how many layers should separate the support material from the part. This parameter contributes to how easy or difficult it is to remove support material from the part once the print is finished. If you have too little gap, the support material will have more of a grip on the part surface making it difficult to remove. If the gap is too large, the support material won't be able to do its job very effectively.

Support Everywhere

If **Support Everywhere** is checked, you're probably going to get more support material than you bargained for. If you have an internal feature of a part, this may be required in order to support it, but keep in mind that it will also add support to features like horizontally oriented holes, which don't normally need support to print properly.

Create Perimeter

Create Perimeter will generate an outline around the support material in order to improve its strength and hold up interface layers.

If you've got multiple extruders on your Eris®, these parameters allow you to specify which extruder is used for generating support structure.

Extruders

Support Material Extruder	<input type="text" value="1"/>
Support Interface Extruder	<input type="text" value="1"/>

On the **Output Options** page is a single parameter, **Center On Bed**. This will automatically center the model on the print bed when you load it. If you don't want that to happen, just uncheck the box.

Center Print

Center On Bed

The **Multiple Extruders** page has two settings that control how ooze & filament wipes are handled.

Wipe Shield Distance mm

The **Wipe Shield Distance** specifies how far away from the part you want what is commonly known as an “ooze shield” to be placed around the part. In a two extruder system, the unselected hot end will create this “shield” in order to avoid dripping or oozing plastic on other parts of the model.

Wipe Tower Size mm

Wipe Tower is used when changing extruders. The active nozzle creates a tower of the specified size and will use it to wipe the nozzle in order to reduce the possibility of oozing or dripping material on the model while the other extruder is active.

10 - Advanced MatterControl: Settings - Filament

The **Filament** tab allows you to change parameters that deal with the current filament you're printing with. The **Filament** page is divided into three categories; **Filament**, **Temperature**, and **Retraction**.

The filament **Diameter** parameter tells the slicing engine the size of the material you're printing with. When starting a new roll of material, you should pull off about 2 meters of material and check it in 10 spots along the length using a digital caliper. Average those samples and plug the result into the **Diameter** field. This is a good way of getting a good estimate of the material you're actually using. This allows the slicing engine to deliver more consistent results instead of depending on the generic size of the material.

Filament	
Diameter	1.75 mm
Extrusion Multiplier	1

You'll notice that the **Diameter** field is highlighted in orange. This means that the parameter is part of a predefined material configuration. When using a new spool of material for the first time, it's a good idea to create a new profile for it when you're taking the sample measurements of the diameter. A good rule of thumb is to include the date you started using the filament as part of the material profile name. Note the date on the spool label if it has one and add one if it doesn't. This will help you track individual spools of the same color and manufacturer.

The **Extrusion Multiplier** parameter allows you to tweak the flow rate of the material coming out of the hot end. A basic rule of thumb on this is to restrict the max value to 1.1 and the minimum value to 0.9. Note that these aren't hard limits but are simply a guideline to utilize until you're familiar with the effects this parameter has on print jobs.

The **Extruder Temperature** is the temperature for the hot end. Each material class has a general temperature range for the hot end. For example, ABS extrusion temperatures can range from 195 to 240C.

Extruder Temperatures	
Extruder Temperature	210 degrees
Extruder Wipe Temperature	0 degrees

PLA likes anywhere from 180 to 215. The specific temperature that your material works best at varies by manufacturer and chemical blend. It's not unusual to see different "sweet spot" temperatures among identical colors of material, even with the same manufacturer.

Extruder Wipe Temperature is only used on those printers that have a special hot end "wipe" feature that can be used to clean the nozzle before a print begins.

Retraction covers how the slicer “retracts” the filament during travel operations where it’s not actually laying down plastic. Good retraction settings help keep your part free of little strings and blobs during printing.

Length on Move specifies how much filament will be backed out of the hot end during a non-printing move.

Length on Tool Change is specific to multi-extruder systems. If the slicer is changing to a new extruder, it will retract the material out of the current hot end by this much. This works in conjunction with wipe towers and wipe shields.

Speed dictates how fast the extruder drive will pull the filament out of the hot end. Higher speeds can assist in preventing already-melted plastic from oozing or leaving strings on the part being printed. It also controls how fast the filament will be returned to the hot end when the non-printing move has completed.

Z-Lift is used to lift the nozzle off of the part as each retract finishes. This can help prevent blobbing.

Minimum Travel Requiring Retraction is used to prevent retractions during very short moves when retraction isn’t really necessary. When executing a non-printing move, the nozzle will have to travel at least this distance in order to trigger a retraction action.

Minimum Extrusion Requiring Retraction specifies how much filament must be extruded before a retraction operation is permitted. This helps prevent instances where a retraction operation would occur before the hot end had the opportunity to actually extrude material.

Retract When Changing Islands if checked, will trigger a retraction when the nozzle is traveling to a different “island” on the current layer. (An “island” is any place on the current layer that has an air gap between it and another “island”.)

Wipe After Retract is used to “wipe off” the nozzle by retracing up to 10mm worth of travel before continuing on. This can help with stringing issues.

Retraction		
Length on Move	<input type="text" value="4.5"/>	mm
Length on Tool Change	<input type="text" value="10"/>	mm
Speed	<input type="text" value="100"/>	mm/s
Z Lift	<input type="text" value="1"/>	mm
Extra Length On Restart	<input type="text" value="0"/>	mm
Minimum Travel Requiring Retraction	<input type="text" value="2.5"/>	mm
Retract When Changing Islands	<input checked="" type="checkbox"/>	
Minimum Extrusion Requiring Retraction	<input type="text" value="0"/>	mm
Wipe After Retract	<input checked="" type="checkbox"/>	

The next page is called **Extrusion** and contains a set of parameters for dealing with the width of the material as it's extruded.

The **First Layer** parameter allows you to specify the extrusion width of the first layer. A first layer width that's larger can help with how the material adheres to the bed. You can specify it as either an actual width, or as a percentage of the normal extrusion with (typically the same as the nozzle diameter).

Extrusion Width		
First Layer	<input type="text" value="180%"/>	mm or % leave 0 for default
Outside Perimeters	<input type="text" value="100%"/>	mm or % leave 0 for default
Support Material	<input type="text" value="100%"/>	mm or %

Outside Perimeters will allow you modify the width of the extrusion when you're printing the outside perimeter of the model. This can come in handy if you need to fine tune the exterior dimensions if they don't exactly match the model.

Support Material allows you to specify how wide you want the extrusion to be for the support structure if you're using it.

The **Cooling** page covers parameters relating to layer cooling.

Cooling Thresholds allow you to slow the print speed down during a print if needed. If the current layer will require more than the specified time to print, the slicing engine will automatically slow the print speed down to meet this goal. This can be important because if you don't use a fan, a layer will need time to radiate its excess heat before the next layer is applied. If the material isn't cooled, or given time to cool via radiation, heat can build up in the underlying layers and cause curling and other undesirable effects.

Cooling Thresholds		
Slow Down If Layer Print Time Is Below	<input type="text" value="40"/>	Seconds
Minimum Print Speed	<input type="text" value="5"/>	mm/s

Minimum Print Speed can be used to ensure that the printer doesn't slow down TOO much, which can cause it's own heating problems. For example, if you're printing too slowly, the presence of the nozzle moving over the surface can cause heating to areas adjacent to the nozzle tip which can cause blobbing or layer deformation.

Note that there are fan options that be present if you've enabled the operation of the fan. Because the Eris® has a combination cooling solution that covers both the cold section of the hot end and the layer cooling feature, the individual fan options are disabled by configuration option.

11 - Advanced MatterControl: Settings - Printer

The **Printer** section covers items that are specific to the printer being used for the current print job.

The **Print Area** page covers parameters that describe the mechanical features of the printer.

The **Bed Size** fields cover the width and length of the bed. Since the Eris® has a round bed, you'll see that both figures are the same, the **Print Center** has been set to 0,0 (the center of the circle) and the **Bed Shape** has been set to **circular**.

Size and Coordinates		
Bed Size	<input type="text" value="125"/>	<input type="text" value="125"/>
Print Center	<input type="text" value="0"/>	<input type="text" value="0"/>
Build Height	<input type="text" value="175"/>	mm
Z Offset	<input type="text" value="0.2"/>	mm
Bed Shape	<input type="text" value="circular"/>	

The **Build Height** parameter should be set to the highest practical build height. In the case of the Eris®, this is set to 175mm. (The actual maximum Z height recorded in the EEPROM may differ due to being updated by the auto-calibration routine.)

Z Offset can be used if you want to set a specific adjustment to the z-zero position of the G-code when it's created by the slicing engine.

The **Bed Shape** parameter dictates what bed type is shown in the 3D viewer.

The **Hardware** section allows you to specify what features are installed on your Eris®.

Has Fan, when checked will allow the slicing engine to control the layer cooling fan.

Has Hardware Leveling should be set for the Eris®.

Has Heated Bed should be unchecked for the Eris®. This allows the slicing engine to control the heat of the bed when one is installed..

Has SD Card Reader should be unchecked for the Eris®. This allows MatterControl to save STL and G-code directly to the SD card if there's one present on the currently connected printer.

Has Power Control should be unchecked on the Eris® as it does not support that feature.

Hardware	
Has Fan	<input type="checkbox"/>
Has Hardware Leveling	<input checked="" type="checkbox"/>
Has Heated Bed	<input type="checkbox"/>
Has SD Card Reader	<input type="checkbox"/>
Has Power Control	<input type="checkbox"/>
Show Reset Connection	<input checked="" type="checkbox"/>
Show Firmware Updater	<input type="text" value="Simple Arduino"/>
Extruder Count	<input type="text" value="1"/>
Heat Before Homing	<input checked="" type="checkbox"/>
Share Temperature	<input type="checkbox"/>

Show Reset Connection should be checked on the Eris®. It will present a “Reset Connection” button in the printer connection bar that can be used as an emergency stop.

Show Firmware Updater should be set to “Simple Arduino” for the Eris®. This controls a feature that allows MatterControl to send firmware updates directly to the printer.

For a stock Eris®, **Extruder Count** should be set to 1. If you add an additional extruder in the future, you can tell the slicing engine about it here.

Heat Before Homing will force the nozzle to heat up to operating temperature before homing.

Share Temperature is used when utilizing multiple extruders that share the same heat source.

The **Firmware** section allows you to tell the slicing engine about the firmware you're using with your Eris®.

G-code Output specifies what “flavor” of G-code should be created by the slicing engine. For the Eris®, this should be set to **REPRAP**.



The next page is called **Custom G-code** and allows you to customize the code sent for five different print events. Unless you're familiar with what the listed G and M codes do, please don't modify the defaults shown.

Start G-code is inserted into the G-code output right after the temperature setting. If you have the commands to set the temperatures in this section, they won't be generated outside of this section. You can also include values from other sections such as "first_layer_temperature"

End G-code is inserted into the output at the very end, after all print operations have been completed.

Pause G-code is sent when the Eris® is paused during a print.

Resume G-code is sent when the Eris® is resumed.

Cancel G-code is sent when you cancel a print job from MatterControl

Start G-Code	G28
End G-Code	M104 S0 ; turn off temperature G91 G1 Z5.0 E-3.5 F12000 G90
Tool Change G-Code	
Pause G-Code	G91 G1 Z10 E-5.0 F12000 G90
Resume G-Code	G91 G1 Z-10 E5.5 F12000 G90
Cancel G-Code	M104 S0

The last page for the **Printer** tab is called **Extruder**. This page allows you to configure each extruder you have installed in your Eris®.

Nozzle Diameter specifies the diameter of the currently installed nozzle in the hot end.

Extruder 1		
Nozzle Diameter	0.5	mm
Extruder Offset	0	0

Extruder Offset allows you to specify the offset from the center of the effector platform in the Eris®. This parameter is only used in multi-extruder configurations.

The last feature I'd like to cover can be found here:

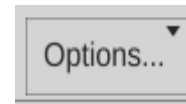

The **Options** control allows you to import and export configurations. This can be handy when you want to share your slicing engine settings with others, or import settings from other sources.

12 - Using the 3D View and Layer View

The 3D View will show you the part that will be printed when you hit the **Print** button. The Layer View is used to inspect how your part will be printed, one layer at a time.

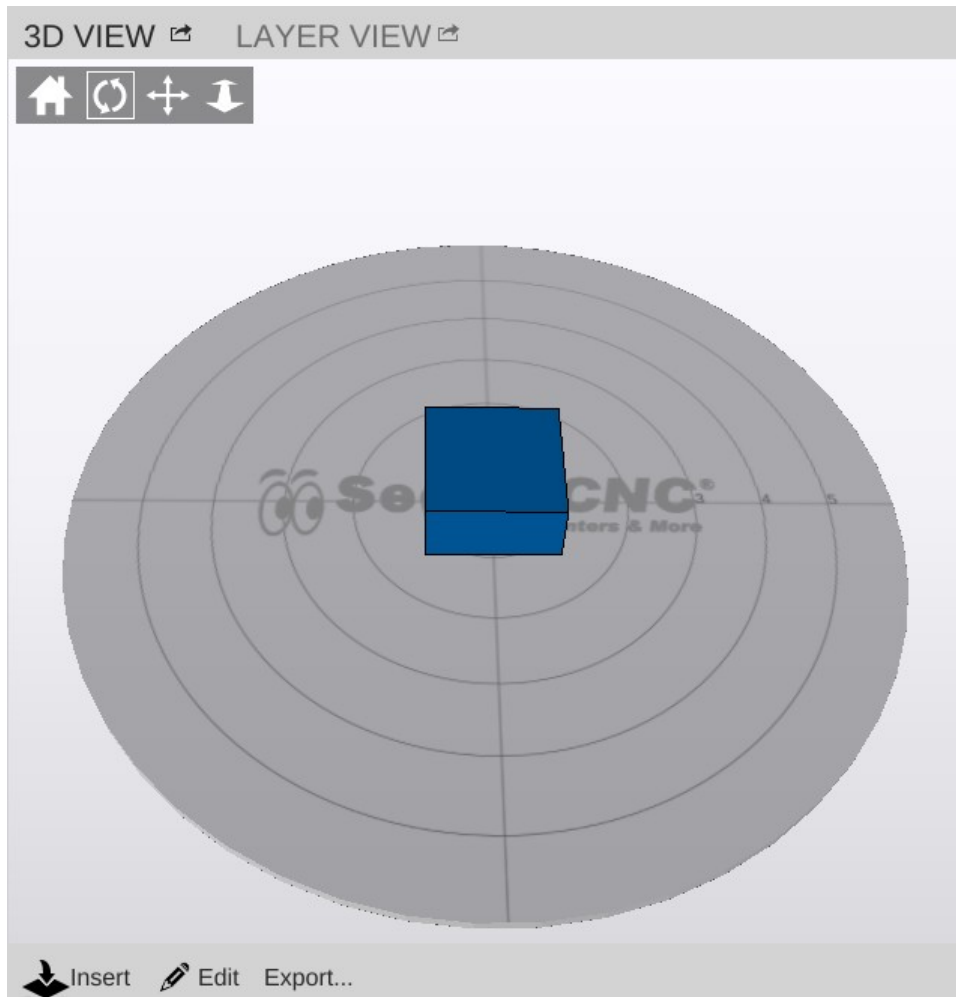

The 3D View will allow you to view your model in pretty much any orientation you'd like. The view orientation is controlled one of two ways. You can select one of the movement icons in conjunction with the left mouse button. The first icon will reset the view. The second icon will allow you to “free rotate” the model and build platform. The third icon will allow you to move the part and build platform left and right, as well as up and down. The fourth icon will allow you to zoom in and out.

You can use the mouse alone as well. Holding down the left mouse button will allow you to “free rotate” the model and bed. Holding down the mouse wheel will allow you to move left and right as well as up and down. Spinning the mouse wheel will zoom in and out.

The 3D View will also allow you to directly manipulate the part or parts currently being displayed on the virtual print bed. The first control, **Insert** is used to add one or more components to the virtual print bed. To give you an idea of how this works in practice, head over to Repables and grab the “Ignite Michiana” object – <http://repables.com/r/146/>.

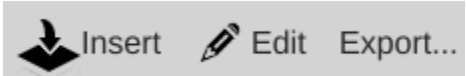

MatterControl is pretty smart – you don't have to extract the STL file from the ZIP file. Click on **Insert** and navigate to where you saved the downloaded zip file and select it. When the file is loaded, your screen should look something like this:

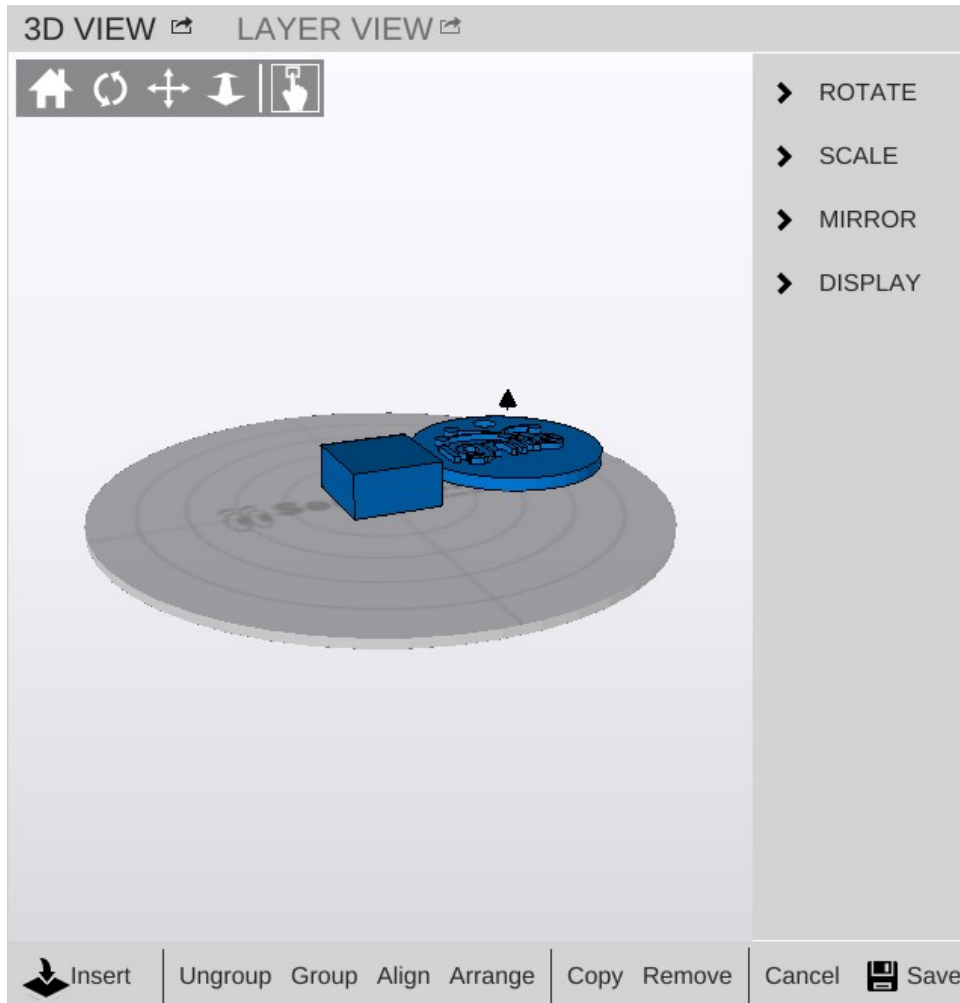

If you didn't already have the example cube loaded, you may only see one object in the center of the bed. If this is the case, go ahead and load another Ignite object.

Click **Save** to “commit” the newly inserted model to the build plate.

You'll end up with something similar to the figure below after clicking on **Auto-Arrange**.

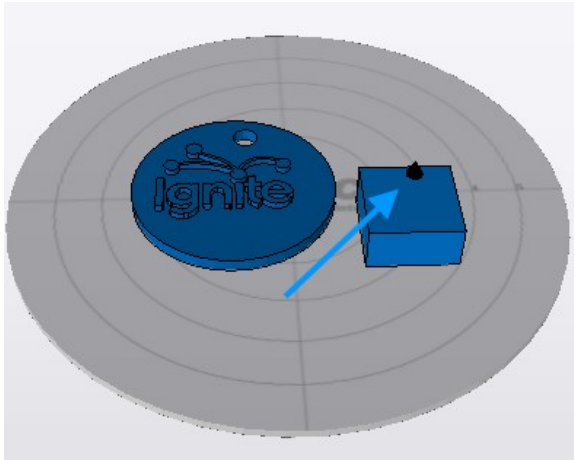

The blue arrow points to a tiny icon that indicates which is the currently selected object.

In order to move an object around manually, you'll need to make sure that the “picker” icon has been



selected. Once you've clicked on that icon, you'll be able to move the parts any where you like. However, be aware that the software will allow you to move the objects outside the confines of the virtual bed and they will not be printable outside of those limits.

You'll notice that you've got some new controls along the bottom of the 3D View window – **Ungroup**, **Group**, **Align**, **Copy**, **Remove**, **Cancel**, and **Save**.

The **Ungroup** button will undo the “grouping” done by the **Group** and **Align** buttons.

Clicking **Group** will virtually connect all the objects on the print bed so they can be moved all at the same time.

The **Align** button has the same effect as the **Auto-Arrange** button, but the resulting group of objects are not centered on the virtual print bed.

Copy allows you to create duplicates of objects that are on the print bed as shown below. Make sure that you've got the object you want to copy selected before you click the **Copy** button.

Be aware that if you've got your objects grouped, clicking on **Copy** will result in the entire group being copied.

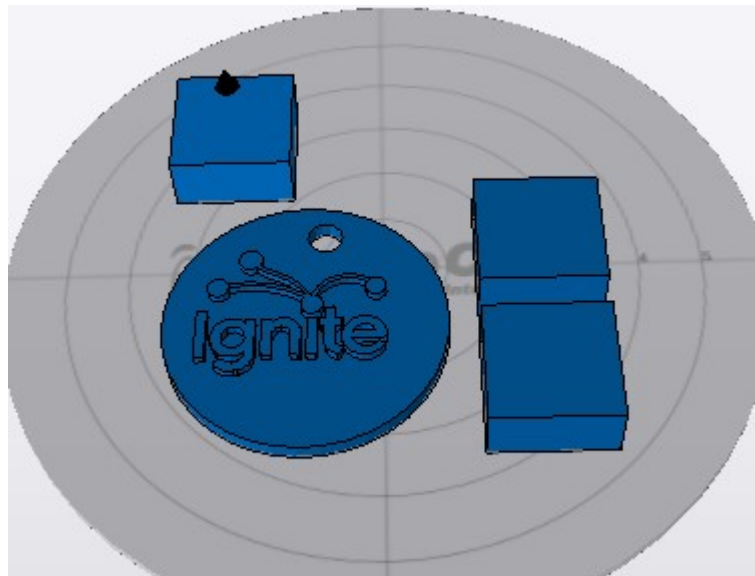

The **Remove** button works as you'd expect. Select an object and click **Remove** to remove it from the virtual build surface.

Cancel will discard any changes you've made so far and **Save** will allow you to save the state of the virtual print surface. Saving your work saves it to the print queue. Note that if you've clicked on **Save**, the **Cancel** button will retain your changes and just exit the edit mode.

While you're in edit mode, there's a series of commands that become available along the right edge of the 3D View pane.

Unlike normal manual positioning, the **Rotate** function allows you to specify the exact rotation of the object along its X, Y, and Z axes.

In order to change the orientation of the object, simply enter the value you want in the **Degrees** field and then click the axis you want to apply that value to. Below is an example of what the example cube looks like after rotating it 45 degrees along its X axis.

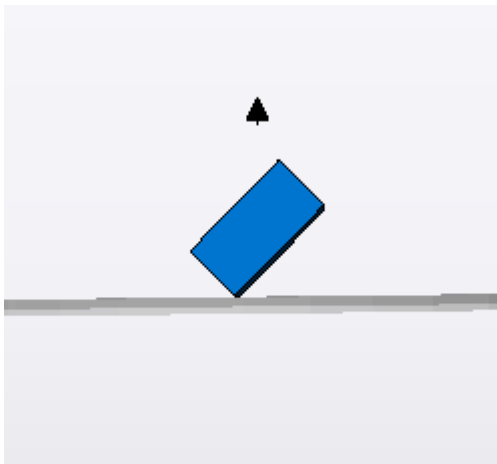
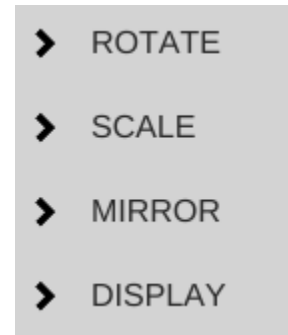
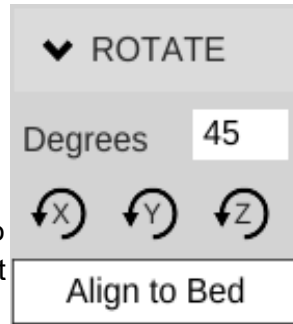

Being able to re-orient the part on the build surface can be handy to have, especially if you're dealing with a part that was saved in a position that didn't lend itself to easy 3D printing.

Clicking **Align to Bed** will automatically orient the nearest flat surface to the virtual build platform.

You can see in the example below what happens when you click **Align to Bed** on a rotated part.

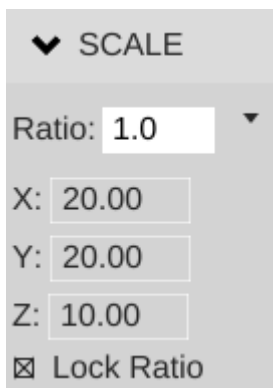
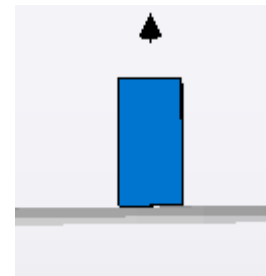

The **Scale** function will allow you to change the width, height and length of the part or parts currently on the virtual build platform.

The **Ratio** field allows you to shrink or grow an entire model by a specific percentage. For example, if you were to change the **Ratio** from 1 to 1.5, you'd see this:



Become this:

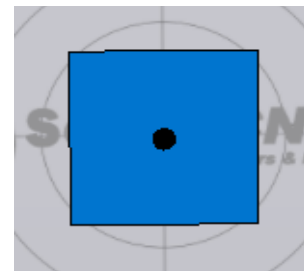

The scaling operation made the cube 150% larger than the original. The **X**, **Y**, and **Z** fields allow you to specify exact dimensions. However, as long as the **Lock Ratio** field is checked, any change made to those fields will adjust the others to maintain the same ratio.



The **Mirror** function will simply allow you to “mirror” the object along any of the three axes. Note that mirroring the Z axis will flip the part upside down, so be careful.

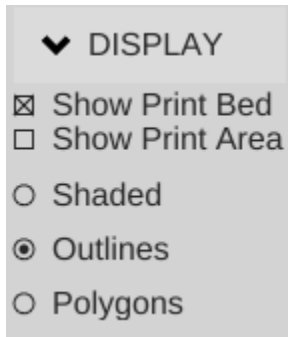

The **Display** function allows you to modify how the 3D View pane operates. **Show Print Bed** is pretty obvious. Uncheck it and see what happens! **Show Print Area** is handy when you want to see exactly how much space your parts are going to take up. When selected, it will display a shadowed cylinder that encapsulates the maximum bed diameter and print height, as show below.

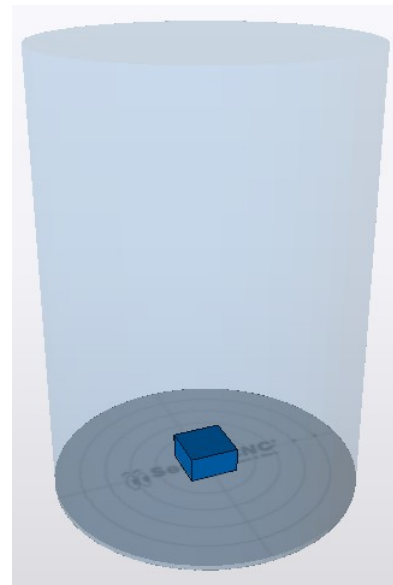

The **Shaded**, **Outlines**, and **Polygons** options allow you to change how your objects are drawn. By default the **Shaded** option is checked. For most parts this is fine, but if you'd like to see detail that the solid shading can hide, click **Outlines**. Models used for 3D printing are built out of a few up to many thousands of polygons. If you'd like to see what the polygons look like that make up your model, click the **Polygons** option.

I find that the **Outlines** display option is the most useful as it makes part detail much more easy to see.

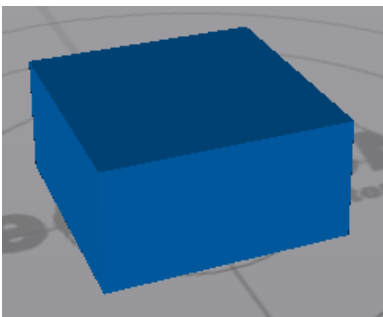

Shaded

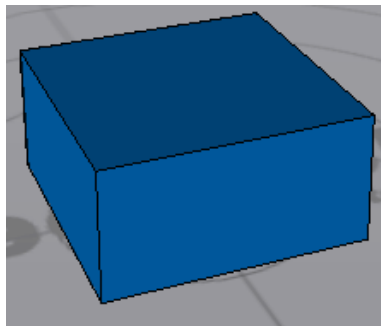

Outlines

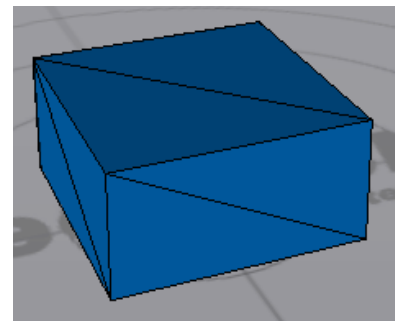

Polygons

The **Layer View** is where you can see exactly what the Eris® is going to do while printing your part. When you first select it, it may show “**Press 'generate' to view layers**”. Click the **Generate** button in the lower left corner of the Layer View display. This will hand over the parts to the slicing engine and will create the G-code required to print your parts.

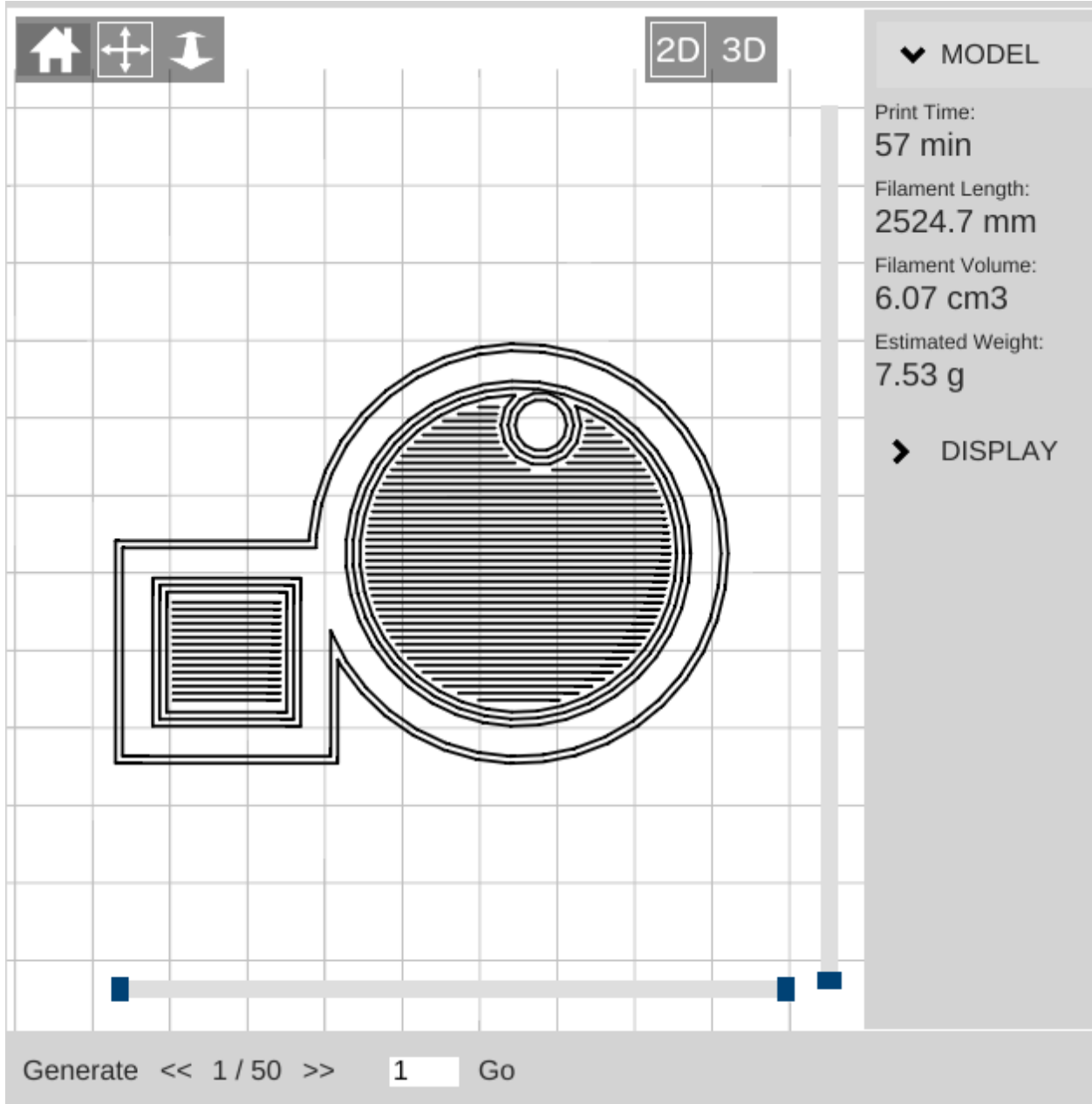

In the image above, you can see that the parts have been sliced and layer #1 is being displayed. Along the right side of the display, you'll see a printing time estimate as well as an estimate of how much filament will be required to print the two parts shown.

There are two “scroll” bars shown in the Layer View. The bar along the bottom will show progress of the current layer, while the vertical bar will show layers. Using the << and >> buttons along the bottom, you can step through the layers one at a time, or jump to a specific layer and click on the **Go** button.

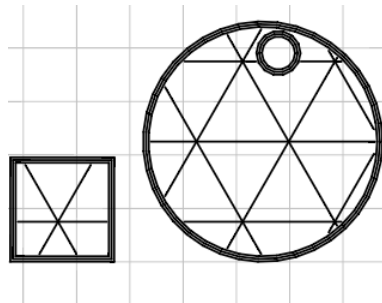

7 Layers in.

The Layer View will also allow you to see the layers in 3D. Just click the **3D** icon at the upper right corner of the display window to see your layers in 3D! The display can be moved around in the same manner as that shown for the 3D View.

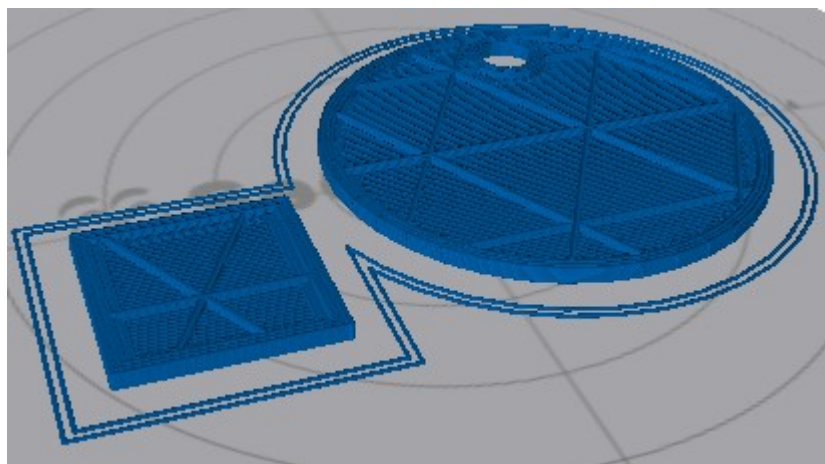

9 Layers in, 3D view.

The Layer View will also display other information about the printing process, such as non-printing movement, retractions, etc.

Click on the **Display** button to the right of the display to open up those display options.

Print Bed hides or displays the virtual print surface.

Moves will show you the path the print head takes when it's *not* printing, as shown by the light green lines in the image below.

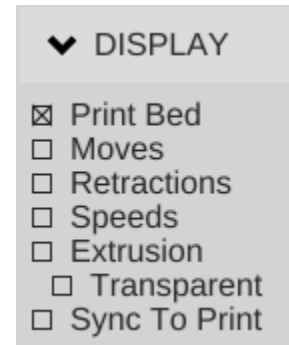
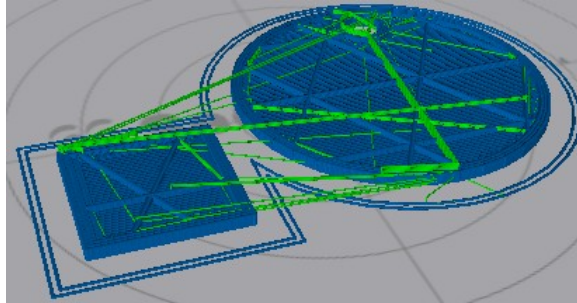

Retractions show the points in the print where the extruder is going to retract filament from the hot end. This is done either during a non-printing move, or when changing extruders.

The red and blue points in the image to the right show where the retractions are happening.

Red shows the retract operation while the blue color shows the resume/extrude.

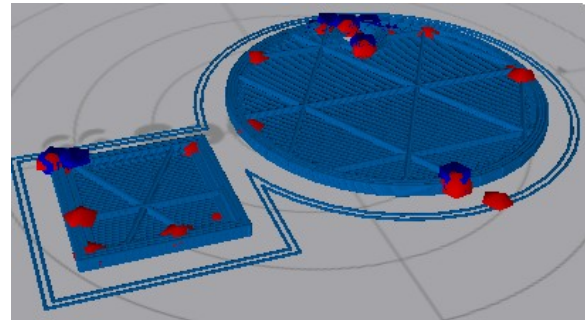

Speeds will color the layers based on how fast the layer is printed.

The **Extrusion** option will thicken the lines used to draw the layers in order to give a more accurate visual representation of what the actual print layer will look like when printed.

Finally, **Sync to Print** will allow you to follow the print process using the Layer View. As the Eris® prints your part, you'll see a real-time reflection of those moves. It's a pretty nice feature.

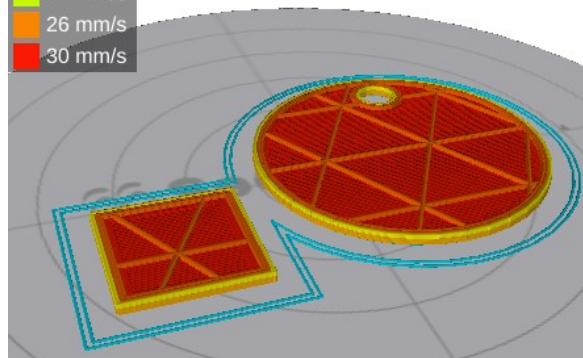

13 - A Strategy for Successful (and Great!) Prints

Michael Hackney is one of our forum moderators over at the SeeMeCNC forum and he's been gracious enough to allow me to publish his wonderful guide for getting the most out of your SeeMeCNC 3D printer. You can find his original thread here:

<http://forum.seemecnc.com/viewtopic.php?f=36&t=7361>

Some of the links below reference part files that are stored on the forum itself. You may need to create a forum account to reach them. I highly recommend doing this whether or not you need the files. The SeeMeCNC is an excellent resource with a vibrant, helpful and very newbie-friendly community.

I've watched folks struggle to achieve the results they want/expect here for several years – heck, I was one of us. Like all new endeavors, there IS a learning curve with 3D printing. This is still the pioneering era for desktop printing and we are very fortunate to have such a great community here as well as other resources on the web. But the challenge with all the information out there is finding it when **YOU** need it and deciphering the many different opinions and practices - some of which are good and some of which are, well, let's just say "poppycock".

There are many different means to the same end but I assert that those who figured something workable (AND reproducible) out most likely took a disciplined approach to reach their goals rather than the shotgun approach of trying one thing after another. So, I thought it would be helpful to describe a method that you can use to 1) develop a reproducible approach to successfully printing the things you want and 2) improving the quality of your prints to meet your (realistic) expectations. I'll likely do this as a series of posts starting with this one. Don't hesitate to join in or ask questions. After some time, I'll consolidate the posts into a single source (maybe a pin here) that will make it easy to find.

On board? Let's go!

#1 Get Experience.

Start with the printer. This is more difficult than it seems because without experience, it is hard to know if you have a mechanical or electrical issue, slicing issue or if something else is going on. So, to that end, keep things simple until you have some experience. By "simple" I mean, don't print the Eiffel Tower model to start, print a simple, reproducible and small item many, Many, MANY times until you nail it. For me, I used the calibration cube. In retrospect, I should have picked something much simpler (see strategy #2).

#2 Start Simple.

We have a tendency to want to jump ahead to more complicated prints, faster printing, bigger prints, etc. There are many aspects to successful 3D printing, everything from the printer (which in itself has a mechanical system, electronics system, hot end, extruder, heated bed, firmware), to the slicer (and all of the parameters available to control the slicing), to the filament itself, to the actual item being printed. With so many variables (100s, maybe 1000s of them) it is really important to pin down as many of them as you can.

One very easy place to do this is with the model itself. Develop your experience printing the same model over and over until you nail it. Even with a simple model, you can (and should) approach printing it with a methodical approach from the ground up. That's the next strategy.

#3 Practice in Measures.

I play guitar and was basically self taught. When I found new music to learn, I did what many untrained folks do and practiced the part over and over again from beginning to end. If I made a mistake, I started over. Then, I took lessons from a trained musician. My very first lesson was worth every penny! My instructor watched me learn a piece and then said "Practice in Measures". What he meant by this was to learn the first measure (music is divided into small blocks of notes called measures which are small and relatively simple). Practice it until it is perfect. Then, practice the second measure until it's perfect. Next, combine the first and second measures until that is perfect. Continue in this way until you've learned all the measures and combinations of them. In complex pieces, there will be a few measures or sequences of measures where you need to put in a lot more practice.

The advantage of this approach, my instructor said, is that you are not wasting lots of time playing measures you already know. The practice of playing from the start until you reach a difficult spot and make a mistake is that you play, say, 30 seconds (or more) of music you already know to hit a 1 second spot you need to practice. So in a 30 minute practice session you are really only practicing what you need to practice for 1 minute! This completely changed my approach to practicing everything from guitar to 3D printing to machining to learning CAD, to ...

How does this apply to 3D printing? Easily, start with a simple object to print and practice nailing the first layer. Once you have that nailed, print the rest of the object. Once you have the entire object printed successfully, change slicing parameters and start over (nail the first layer, ...). Practice in measures.

I can't say enough about getting that first layer right, the subject of the next strategy.

#4 Nail the First Layer.

I don't believe folks spend enough time learning to print a perfect first layer reliably. If there are defects in the first layer, they will invariably come back later to bite you - the part separating from the build plate or a defect in the part. Trying to print a good (or great) first layer is probably one of the most frustrating experiences for most, it is also the most critical. Here's where strategy #3 comes to play, don't continue a print on an inferior first layer! Abort the print and start that first layer again and again until you nail it. Why waste time on a part that will most likely fail or not be useful? Each time you print a first layer, *measure it!* If you tell your slicer to print a 0.20mm first layer, then it should be pretty darn close to 0.20mm. If it isn't, you've identified a variable that you can easily fix and nail down (Z height). 0.20mm is not a lot and unless you have highly calibrated eyes, you can't tell the difference between 0.20 and 0.15mm, but your printer sure can. At 0.15mm the first layer is going to squish onto the print surface.

It may even seem like you are getting a great first layer and great sticking (which you are) but later, you'll discover the part is nearly impossible to remove or your extruder will start making that all too familiar TICK, TICK, TICK sound from missing steps. A perfect first layer will go down smooth and consistently time after time.

TIP: polish the tip of your nozzle! Charred filament and scratches on the very tip of the nozzle are dragged over the layers as it moves around. Best case these leave a visible mark on the print, worse case they rip the first (or higher) layer off the build plate.

#5 Slow Down.

Back to my guitar lesson example... The other thing my instructor taught me in that first lesson was to practice slowly (using a metronome) until I nailed the measure(s) at a slow tempo. Then, gradually and consistently, increase the speed. The same applies to 3D printing, print slowly at first. This gives you time to observe what's going on (strategy #6) and just simplifies everything. I like to start new folks at 20 to 25mm/s print speeds. What's the hurry? If you print 10 aborted prints at 50mm/s what have you gained (or lost)? Printing slow helps all parts of the printer, from the mechanics to the extruder to the plastic filament coming out the nozzle, stay in balance or equilibrium. Fast movements can highlight mechanical issues, extrusion issues, etc. But when you are first starting out, you don't know how to identify and isolate these issues. In fact, even with all of my experience, if something starts to go wrong, I slow down. That removes a lot of variables and gives me a chance to see what's happening. I've identified everything from loose pulleys to a worn joint on a delta arm to separating arms on magnetic ball joints! And, I've helped a lot of folks identify other issues simply by slowing down.

#6 Watch What's Happening.

Especially in the early stages of learning, watch all aspects of the printer. Combined with strategy #5 you'll start to develop an appreciation for how the slicer does its magic, how the printer does its magic, and it is just simply fun to watch (especially a delta printer)! I highly recommend putting a flag of some type on your extruder so you can actually watch retracts and advances and watch the steady push of the filament. A piece of masking tape stuck to the shaft is fine or print one of the pointer models. Watch that first layer print, that's how you'll see if there is a problem and maybe even figure out why. For example, I noticed that the first layer wasn't sticking in the same spot on my build plate. Turns out that I had some potato chip grease there (don't ask)! A little wipe with isopropyl alcohol and I was back in business. Watch what happens when the layer fan comes on. Is it coming on too early and causing the part to peel from the print surface? Pay attention to the details of what's going on and then...

#7 Keep Notes.

I can't stress how important it is to keep notes. I have a word processor file I add notes to as I go. In particular, I keep a section on the filaments I use and the detailed printing parameters for them (strategy #9). Perhaps I'm becoming forgetful in my advanced age but I don't like solving the same problem over and over again. If I keep a note about a problem and my solution, I can usually find it again pretty quickly. Once comment on notes, don't be afraid to purge! After a few years of doing this, my file got quite big.

Recently I archived all of my H1 and H1-1 notes. I don't refer to them any longer so why keep them in my working notes?

#8 Be Consistent.

A CEO friend I worked with many years ago was fond of saying "Consistency is the hobgoblin of small minds!". I understood what he was trying to say but it has to be taken into context. When you are first learning any new activity, it is critical to be consistent. If too many things are changing at once, you have no idea what contributed to a good or bad result. Don't change too many things at once. In fact, if you can isolate and change just ONE thing, you will have a much better chance of success and understanding. This isn't always possible so lock down as many things as you can. If after a run of successful printing you run into a problem, go back to a known good state (see #7 - you did keep notes on what this state was didn't you?) and start there. Many times we try to change too many things in our frustration and that almost always makes things worse. Step back and think about how to isolate the problem areas with as few changes as possible.

#9 Know Your Filament.

This strategy is a bit lower level than the previous eight but important and often overlooked. I see a lot of folks just assume that they should print filament X at temperature Z - for instance, print PLA at 200°C. This might get you in the ball park but if you really want to get to consistent and GREAT results, profile your filament. It's easy and if you write it down (see #7) you'll never second guess how best to print that filament again. It's important to realize that higher temperatures are not always better, they can actually lead to issues - parts that are just a little too large, parts that stick to the bed too well and can't be removed, blobs on the print, stringing, and a host of other problems. In general, I like to print at the lowest temperature possible for PLA and ABS. Then, as I ramp up print speed, I also need to ramp up the hot end temp a little since the filament is not resident in the hot zone for as much time. I suspect little details like this cause people more problems than they might anticipate.

Here's how I profile a new filament:

- Start with a reasonable target temperature - 200°C for PLA and 225°C for ABS (one quick note, it is ideal to have a calibrated hot end, so when I say 200°C I mean 200°C. One easy way to do this is to make a little table with the hot end set temperature (what you see on the temp display) and the measured temperature (with a thermocouple). Do this in 5°C increments from 160° to 240° C (or so). Keep this chart in your notes (#7) and you will always know what the actual temperature is.)
- Now, use the manual controls of your host to extrude 50mm at 50mm/s and watch and listen.
- If the filament extrudes nicely, reduce the temperature by 5°C and wait for the temperature to stabilize.
- Test again by extruding 50mm at 50mm/s
- Repeat until you reach a temperature where the filament does not extrude well. At 5°C to that temperature and note this as the "low extrusion temperature" for that filament. Use this low temperature whenever you are printing slowly (20-30mm/s). You might find some

filament need to be bumped up a bit more than 5° so don't hesitate to experiment and find that lowest reliable extrusion temperature.

If you want to get really serious about profiling your filaments, do the melt-flow test at higher extrusion rates - 60 mm/s, then 70mm/s, etc.

Don't forget to measure the diameter of your filament too! Not all filaments are created equally. Measure in several locations to get a sense of variability. Most of the slicers let you enter filament diameter and they will calculate a reasonable flow for you.

TIP: When you are starting a new print session, give the printer a little warm up exercise! Much like an athlete warms up before a game, don't just turn the printer on and attempt to print. Turn it on and let the hot end get up top equilibrium, let the heated bed get up top temperature. I even like to print a quick part (a 20mm diameter cylinder 5 mm tall) to make sure everything is up to temp, in equilibrium and working properly. It's quick and easy to do and can help eliminate a lot of problems.

#10 Know Your Bedfellows.

Probably one of the greatest mysteries in 3D printing is "the bed". Metaphorically, this is where the rubber (filament) meets the road (bed) and getting "it" right is absolutely critical to successful fused filament 3D printing. All sorts of folklore on bed materials, coatings, coverings, concoctions, and juju exists here and elsewhere on the internet. It is also one of the areas that there is no one right way to do it. If you have discovered a special incantation and bed preparation that works, by all means stick with it! But, for those of you struggling, here are some strategies you can use to make improvements. One comment before I begin...

I am VERY persnickety about the aesthetics of my 3D prints. My 3D printed fly fishing reel is seen from all sides and so it is important that the first layer is flawless and visually appealing. A perfect first layer finish is not required for all objects - consider the base of a Yoda or vase - but if you practice getting a great first layer on these non-critical pieces you'll be prepared when you need a visually perfect first layer on another project.

A number of factors affect adherence of the first printed layer to the bed. These include:

- surface material
- surface texture
- surface treatment/coating
- bed temperature and uniformity of temperature
- air temperature
- chemical bonding or cohesion
- print speed (see #5)
- filament temperature (see #9)
- first layer height (see #4)
- cleanliness (of bed and filament)

This isn't an exhaustive list but it does include the big hitters and, as you can see, there are a few of them so it is very important to take a methodical (#2 and #8) and documented (#7) approach when solving bed-related problems. This is also a place where careful observation (#6) can play an important part.

I'm not going to go through all of these in detail now but did want to comment about the last one - cleanliness. Whatever you do, make sure everything near and on your printer is clean and grease free. Silicone greases and lubricants are especially problematic since they are invisible and very difficult to remove. Keep them away from your machine.

Your fingers are a prime source of contaminants. Every time you touch the filament or bed, you risk leaving a greasy print (see my observation in #6) and these can (and will) cause issues. I try not to handle filament with my bare fingers, I use cotton gloves. If you use a plastic or rubber glove, make sure it isn't coated or powdered - we're trying to eliminate sources of contamination, not introduce them. On the occasions that I do handle filament with my bare hands I wash and dry them thoroughly first. This is one area that I think affects a lot of user's and is completely overlooked. How many times have you loaded filament right after eating chips? It introduces a big variable that can be difficult to track down, so develop good habits and eliminate contamination as a variable.

Your fingers can also leave contaminants on the bed when you remove a part or brush off stray filament strands. Don't touch the bed surface if at all possible. If you do, clean/degrease it with an appropriate cleaner. For uncoated surfaces like borosilicate glass, PEI, the various 3d party surfaces (PrintInZ and BuildTak), and films (window tint, Kapton) you can use isopropyl alcohol. I like to use the little packages of wipes as they are convenient and safe. You can also do a quick wipe of your fingers before tossing it in the trash. It is more difficult to deal with coatings like PVA glue, glue stick, and hairspray since these can't be cleaned. If you suspect a contaminated coating, your only recourse is to remove and reapply it.

Finally, don't overlook filament storage, keep it clean too. I store mine in large zip lock bags to keep off dust. You can put packets of desiccant to help remove moisture in the bag too.

#11 Learn to Diagnose.

Patient: "Dr. it hurts when I move my arm like this."

Dr.: "Then don't move your arm like that!"

The first point of this joke is, many people do the same thing over and over again without making any changes or stopping to think about what to change (see #8: remember, change one thing at a time) - as if just repeating the same print with the same parameters will magically solve the problem. It won't (see my footnote below).

The second point of the joke is that the Dr. didn't attempt to actually determine why the patient's arm hurt, he just had him avoid the problem. I see that a lot too. Usually it takes to form of "I tried printing it with my red PLA and it failed but everything was fine with my blue PLA".

There are many other variations on this (changing slicers for example).

Learn how to diagnose problems. This requires careful observation (#6). Once you've identified where the problem occurs (let's say getting the first layer to stick) then PRACTICE that piece (see #3) until you sort it out. No need to run through the entire process over and over. Isolate the problem, formulate a hypothesis on what you think might be happening and design a test to prove or disprove your hypothesis. If you see a problem and can't formulate a hypothesis THEN seek help! Or, pre-test your hypothesis here to get some experienced feedback. But, whatever you do, try to work through the diagnostic process yourself first, that's how you learn.

Footnote: Many years ago (20) my company had an annual laboratory safety week (I worked in a corporate R&D lab with lots of nasty stuff). One of the annual favorites was a gentleman from OSHA who talked about electrical safety. He started his presentation with a black and white video from the 1940s (I think) of a speaker walking up to a microphone on stage. The presentation was being filmed. The speaker reached up and grabbed the mic and was immediately thrown back and fell to the stage unconscious. Members of the audience rushed up to help him. This was all on video. As 4 or 5 people worked to help the victim, you see a gentleman casually walk up to the mic, reach out his hand and touch the mic. He was immediately thrown back and collapsed on the stage next to victim #1. Literally 30 seconds later a THIRD audience member walked up to the mic (now there are 2 victims on the stage and a hoard of people working to revive them) and *carefully* reached out his finger (looked like the scene from ET) and very, very gently touched the mic with just the tip of his finger. He was immediately thrown to the stage as the third victim. All of this was caught on video. No one died (we were told). Neither of the second two victims stopped to think about the problem, consequences or solutions.

#12 Be a Fanboy.

I am probably going to lose some fans for this post about cooling fans!

Don't think of a part cooling fan as an object. Instead, think about "air flow". If you need cooling on a PLA (or other material) part, then you need to understand air flow. Not all cooling fans are created equally. Consider this, some folks use a 40mm, some a 25mm, some (like me) a 25mm squirrel cage fan. Some are mounted to blow the full fan width stream at the nozzle area, some have a duct or some (like mine) have a very focused soda straw duct). So comments like "run your fan at 1/2 speed" are not specific enough to be useful information. Instead, you need to understand how your particular fan, it's arrangement, your material, etc, all relate to the air flow.

Firstly, using the previous strategies, try to minimize or eliminate the need for any sort of air cooling. Slowing a print down (#5) is one great way to do this. It also gives you a chance to see (#6) where any problem areas on a print might be. You can use this information to focus the *right amount* of air flow on the problematic areas. The tendency for many is to use as much air as possible. It is much better, more consistent, and more reliable to use as little air flow as necessary. This puts less thermal stress on the printed part.

When you do determine you have a problem that only a fan can solve, start conservatively. I also seriously recommend using a duct of some sort to focus the air flow where you need it. Ideally, the fan would have the ability to follow the print nozzle and direct a small stream of air to the filament right after it is laid down. That is a difficult problem to solve, so most of us direct the air to area around and under the nozzle. But, by directing the air (duct) you can reduce the air flow significantly since it is now focused where you need it. Here is an example of some of my fan research. The part on the left failed (in a previous run) as you can see due to warping caused by an uneducated 25mm inducted fan blowing at 50%. The part being printed on the right was my first attempt at using flexible soda straws (2 of them) to direct the air flow to exactly where I needed it. I also ran the fan at 20%

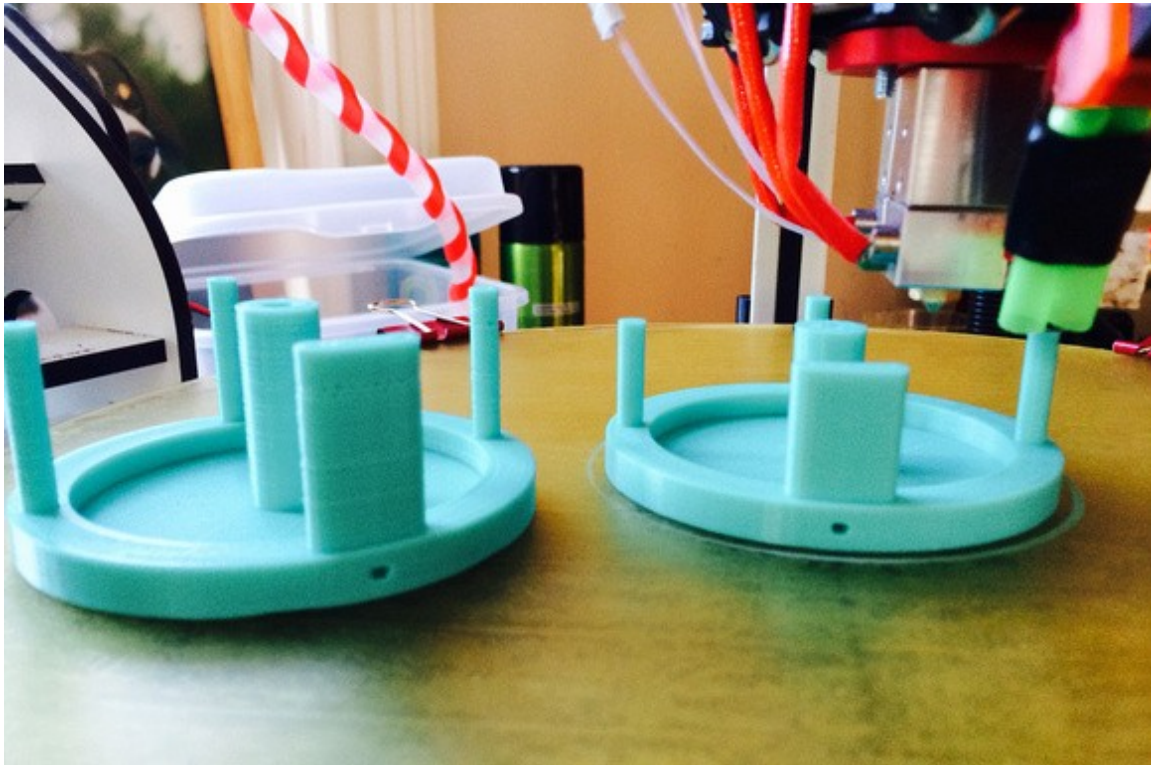

The angle of the photo doesn't show it clearly but the "double barrels" are focused at the tip of the nozzle. The "dead air" space between the tubes prevents air from flowing over the nozzle. I know, it's terribly clever! It's a work in progress and I've almost got it perfected with a printed double barrel nozzle.

I suggest doing your own experiments and observations but start conservatively. I don't use a fan during the entire part. If you find you need to turn the fan on at full blast from no air flow, do it in stages so the hot end can equilibrate properly. You can do this manually, some slicers can support it, or it is easy enough to learn the simple "fan mcodes" to manually insert them where you need them in the gcode file (this is what I do for tricky parts).

M107 is fan off

M106 S50 turns the fan on at 50% - the S parameter is the speed from 0 to 100

Using a focused air flow, lower air flow and the step up technique I just described, you won't see a significant drop in hot end temperature and you won't see a tell tale sign on the part that the user 'Polygonhell' mentions. PLA has this interesting property that if you change the extrusion temp at the hot end, it has a visible effect on surface sheen of the part from matte to gloss as you raise the temperature. [RichRap has written an excellent post](#) about how he uses this phenomenon when printing decorative vases. Although he was varying the hotend temperature, a similar effect can occur with improper air cooling.

I'm also an advocate of using off-platform cooling. By this I mean strategically placed (ducted) fans that direct air to problematic areas of a print. These can be mounted to your vertical columns or simply sat on the bed if it is not too hot. With ducting, you can reduce the air flow considerably and keep the cooling right on a "hot spot". This technique does require manual adjustment, repositioning, etc. But, if you are trying to print a really tricky part, it might be the only way to do it. Frankly, the part cooling capabilities of desktop 3D printers is extremely primitive at this point. It's fine for the majority of objects you might print but as we push the envelope on what's possible, part cooling is one area that needs some more work to automate it.

Consider this, the way I maintain very tight tolerances on the rotating spindle and hub assemblies on my fly fishing reels is to use a low beam of air cooling on the spindle as it's printed. This "locks" the filament in place in a very predictable way. Once I printed a few parts and measured them to make sure there was little variation, I incorporated that into the design to get exactly the tolerance these parts required.

Calibration things:

This first set is a 20mm diameter cylinder, 0.6mm tall. There are 3 variations and the all width is the first part pf the STL file name. Start with the pt4mmx20mm-cylinder.stl if you have 0.4mm nozzle orifice. You can use these to:

- 1) get first layer adhesion to the bed
- 2) first layer thickness (stop the print after first layer and measure it)
- 3) total print height (should be about .6mm)
- 4) X-Y calibration (should be 20mm diameter)
- 5) eliminate blobbing and other surface artifacts - follow the guide above, print slow, adjust retracts, etc. KEEP NOTES!

pt3mmx20mm-cylinder.stl

<http://forum.seemecnc.com/download/file.php?id=8207>

pt4mmx20mm-cylinder.stl

<http://forum.seemecnc.com/download/file.php?id=8208>

pt5mmx20mm-cylinder.stl

<http://forum.seemecnc.com/download/file.php?id=8209>

pt6mmx20mm-cylinder.stl

<http://forum.seemecnc.com/download/file.php?id=8210>

[Highcooley's Onyx Bed Leveling Aid](#) is a great one to test your calibration. Highly recommended. If you can print it perfectly you've "arrived". I couldn't find a similar thing for the Eris®. If you know of one, let me know and I'll add it.

texsc98 took the challenge and created a [parametric version](#) that has defaults for Eris®.

Layer Tuning

You can use this set of files in a number of ways - everything from testing calibration results to exploring slicer options to breaking in a new filament. These are designed for a .2mm layer height.

The first cylinder (pt2mm tall) I call the Simple Single Layer Test and is my workhorse calibration object for tuning first layer adhesion issues, profiling new filaments and host of other uses. It is one layer high and can be used to test adhesion to the bed and first layer thickness (measure it with a micrometer or calipers and compare to what the first layer height was supposed to be). You can use this to tune your printer and slicing parameters to get perfect infill and explore the effects of speed on infill quality without wasting a lot of time and filament printing larger parts poorly. I also use it when I am testing a new filament to dial it in. It's a really versatile tool and I use it every day.

75mmDisk-pt2mmtall.stl

<http://forum.seemecnc.com/download/file.php?id=8475>

This cylinder is .4mm tall, or two layers. It can also be used similar to the first cylinder but the second layer will show issues in orthogonal movements to the first layer. It also provides a little more thickness to measure to verify layer height. It can also help tune the top capping layer.

75mmDisk-pt4mmtall.stl

<http://forum.seemecnc.com/download/file.php?id=8476>

The last cylinder is .6mm tall, or three layers. Again, it can be used like the first two. I don't use it as often.

75mmDisk-pt6mmtall.stl

<http://forum.seemecnc.com/download/file.php?id=8477>