

END POST

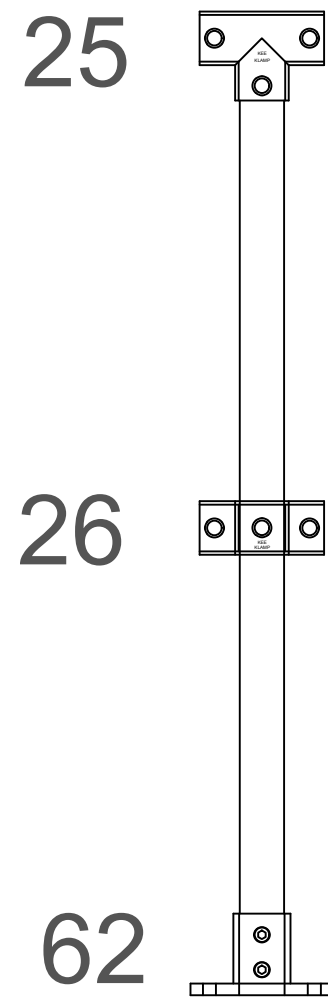

INTERMEDIATE POST

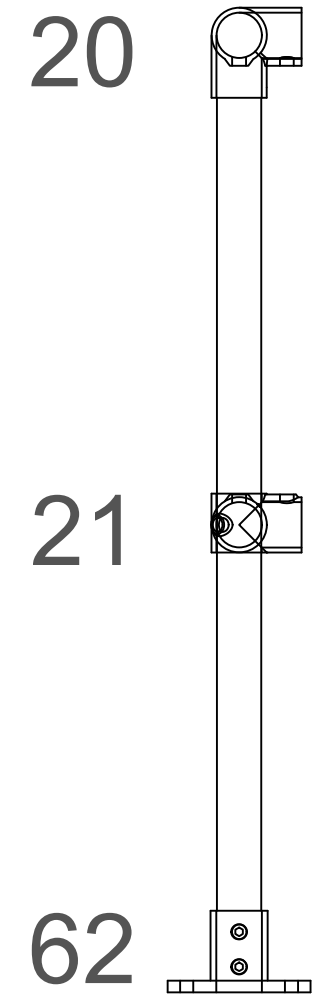

CORNER POST

0	00-00-00	ORIGINAL ISSUE		DWN. BY	EMD	All Information Contained in this drawing is the sole property of Safety Rail Source. Any reproduction is prohibited without the written consent of Safety Rail Source.
REV.	DATE	DESCRIPTION	Company Name - Job #	CHK'D BY		
REVISION & SUBMITTAL RECORD				SCALE	REV.	
Safety Rail Source 2570 Boulevard of the Gen. #200, Norristown, PA 19403 PHONE: 610-539-9535 FAX: 610-539-1630 WEBSITE WWW.SAFETYRAILSOURCE.COM			62 POST	NONE	0	
				DWG. No.	N/A	

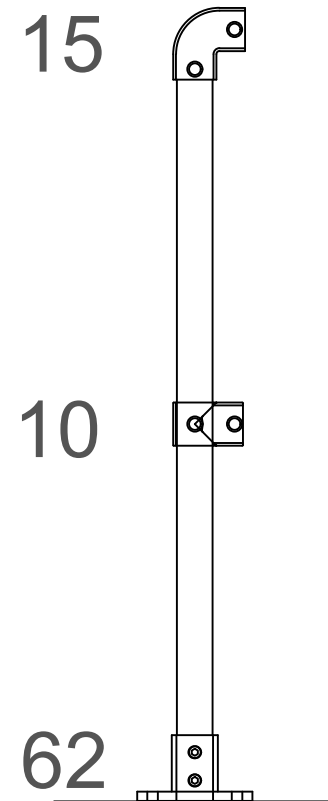

END POST

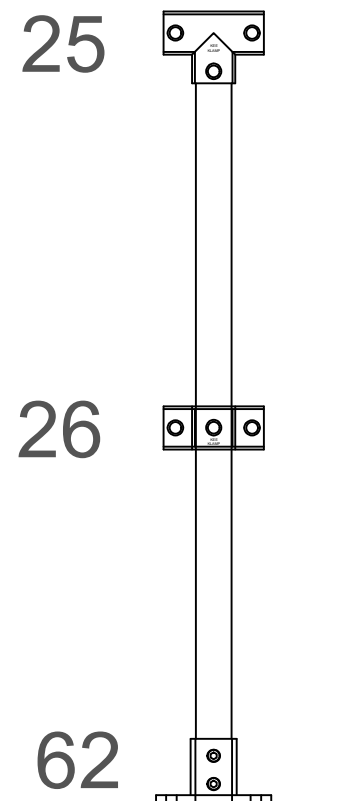

INTERMEDIATE POST

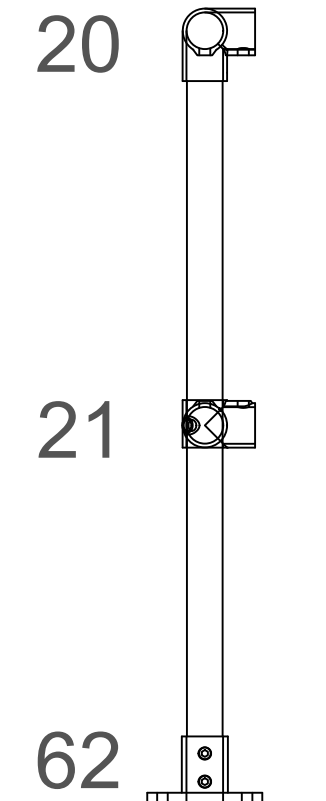

CORNER POST

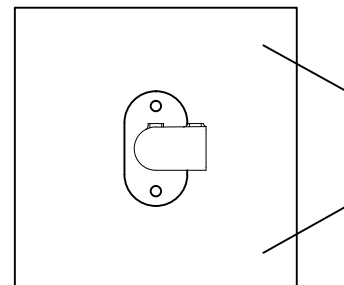

ATTACH PLATES TO ROOF USING (10) SELF TAPPING SCREWS OR RIVETS.

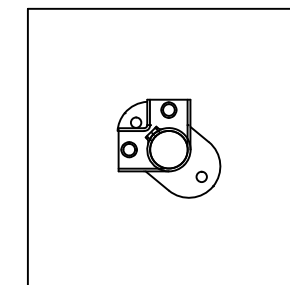
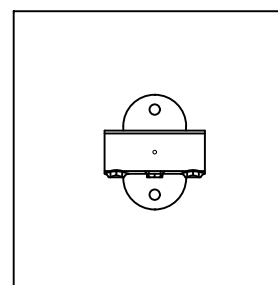

0	00-00-00	ORIGINAL ISSUE
REV.	DATE	DESCRIPTION
REVISION & SUBMITTAL RECORD		
Safety Rail Source		
2570 Boulevard of the Gen. #200, Norristown, PA 19403		
PHONE: 610-539-9535 FAX: 610-539-1630		
WEBSITE WWW.SAFETYRAILSOURCE.COM		

Company Name - Job #
<u>62 POST w/</u> <u>ALUMINUM PLATE</u>

DWN. BY	EMD
CHK'D BY	
SCALE	NONE
REV.	0
DWG. No.	N/A

All Information Contained in this drawing is the sole property of Safety Rail Source. Any reproduction is prohibited without the written consent of Safety Rail Source.

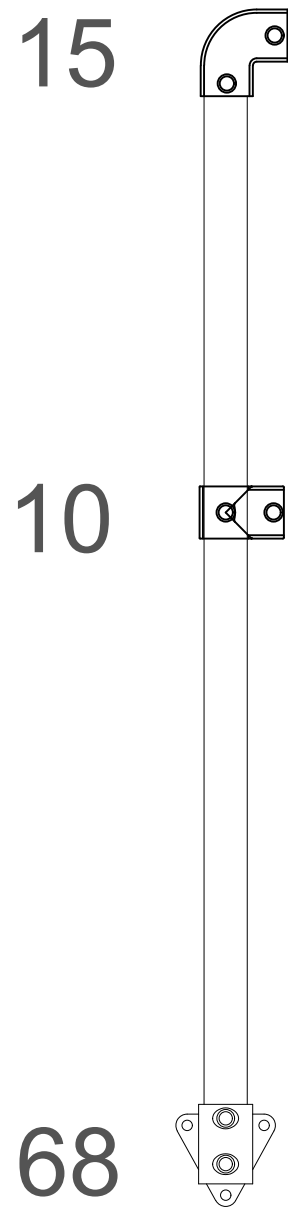

END POST

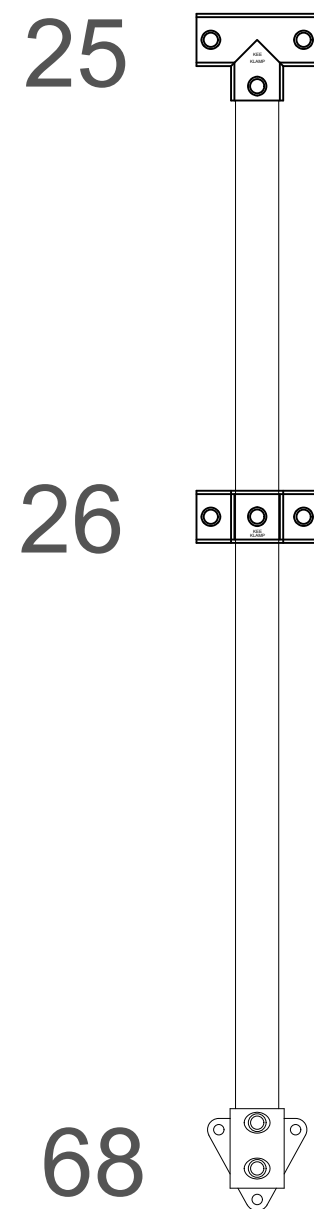

INTERMEDIATE POST

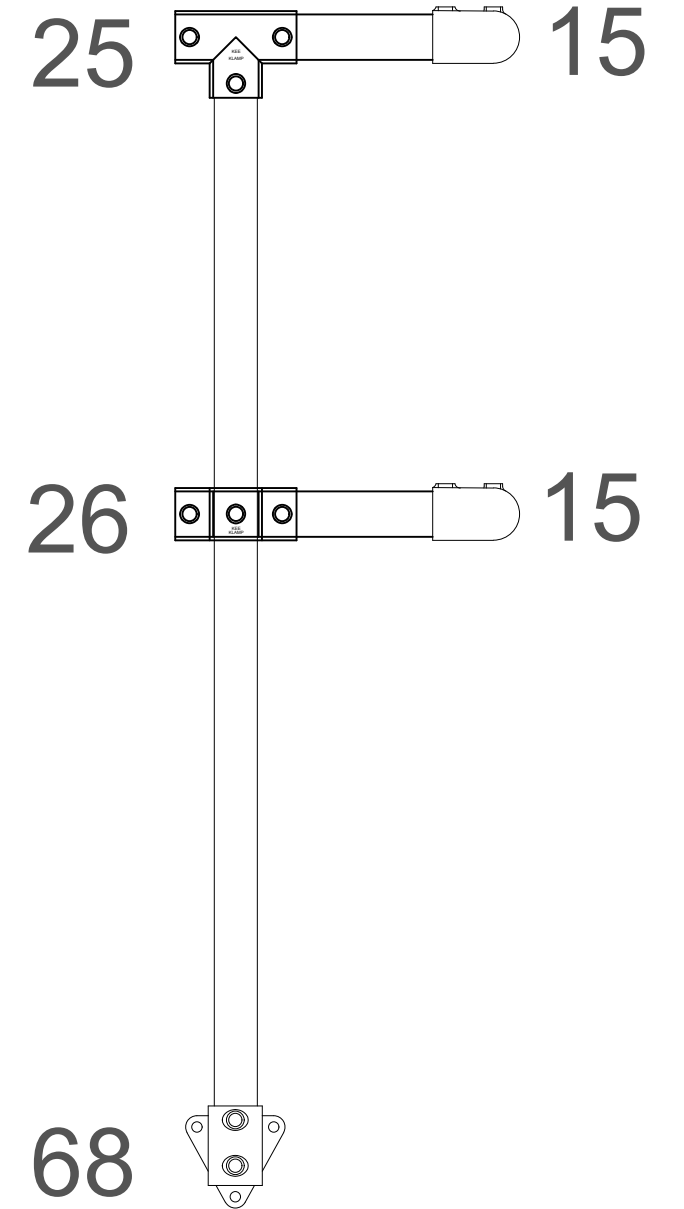

CORNER POST

0	00-00-00	ORIGINAL ISSUE		DWN. BY	EMD	All Information Contained in this drawing is the sole property of Safety Rail Source. Any reproduction is prohibited without the written consent of Safety Rail Source.
REV.	DATE	DESCRIPTION	Company Name - Job #	CHK'D BY		
REVISION & SUBMITTAL RECORD				SCALE	REV.	
Safety Rail Source 2570 Boulevard of the Gen. #200, Norristown, PA 19403 PHONE: 610-539-9535 FAX: 610-539-1630 WEBSITE WWW.SAFETYRAILSOURCE.COM			68 POST	NONE	0	
				DWG. No.	N/A	

62-8



68-8



10-8

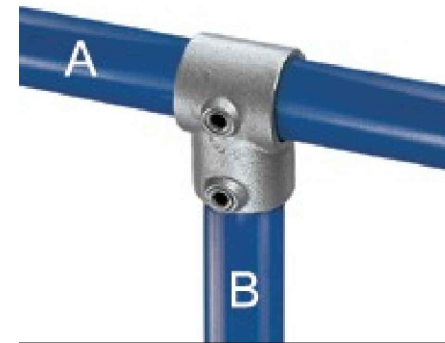

15-8

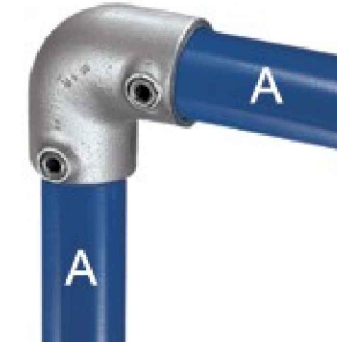

20-8

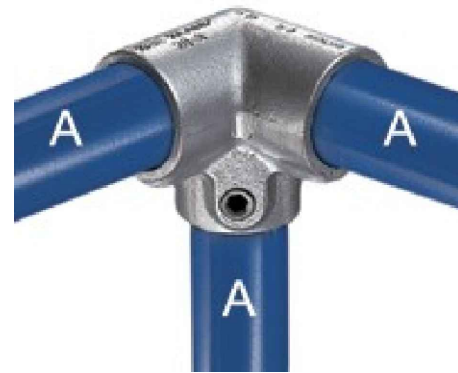

21-8

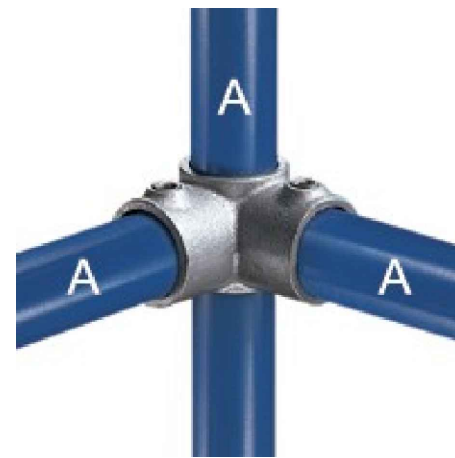

26-8

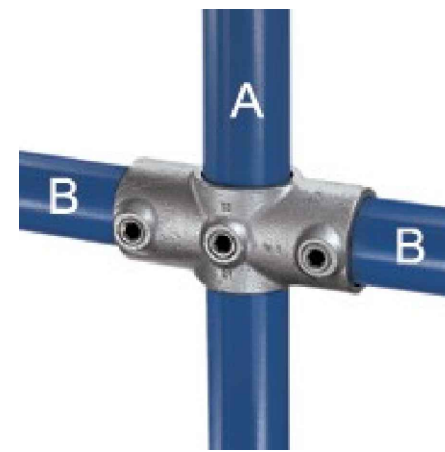

25-8

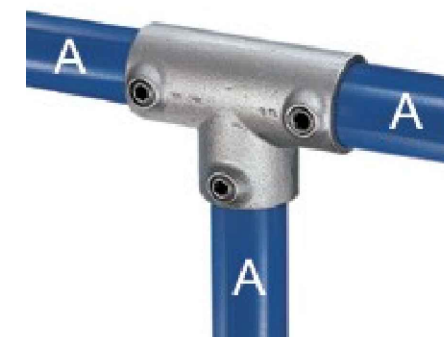

0	00-00-00	ORIGINAL ISSUE
REV.	DATE	DESCRIPTION
REVISION & SUBMITTAL RECORD		
Safety Rail Source		
2570 Boulevard of the Gen. #200, Norristown, PA 19403		
PHONE: 610-539-9535 FAX: 610-539-1630		
WEBSITE WWW.SAFETYRAILSOURCE.COM		

Company Name - Job #
FITTINGS GUIDE

DWN. BY	EMD
CHK'D BY	
SCALE	NONE
REV.	0
DWG. No.	N/A

All Information Contained in this drawing is the sole property of Safety Rail Source. Any reproduction is prohibited without the written consent of Safety Rail Source.

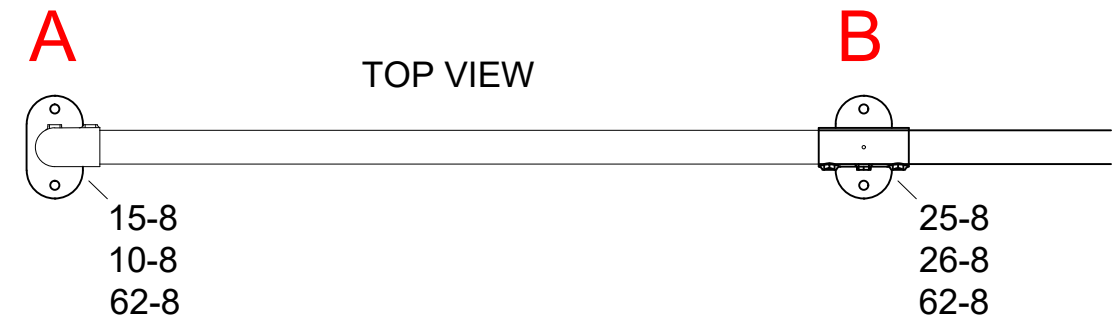
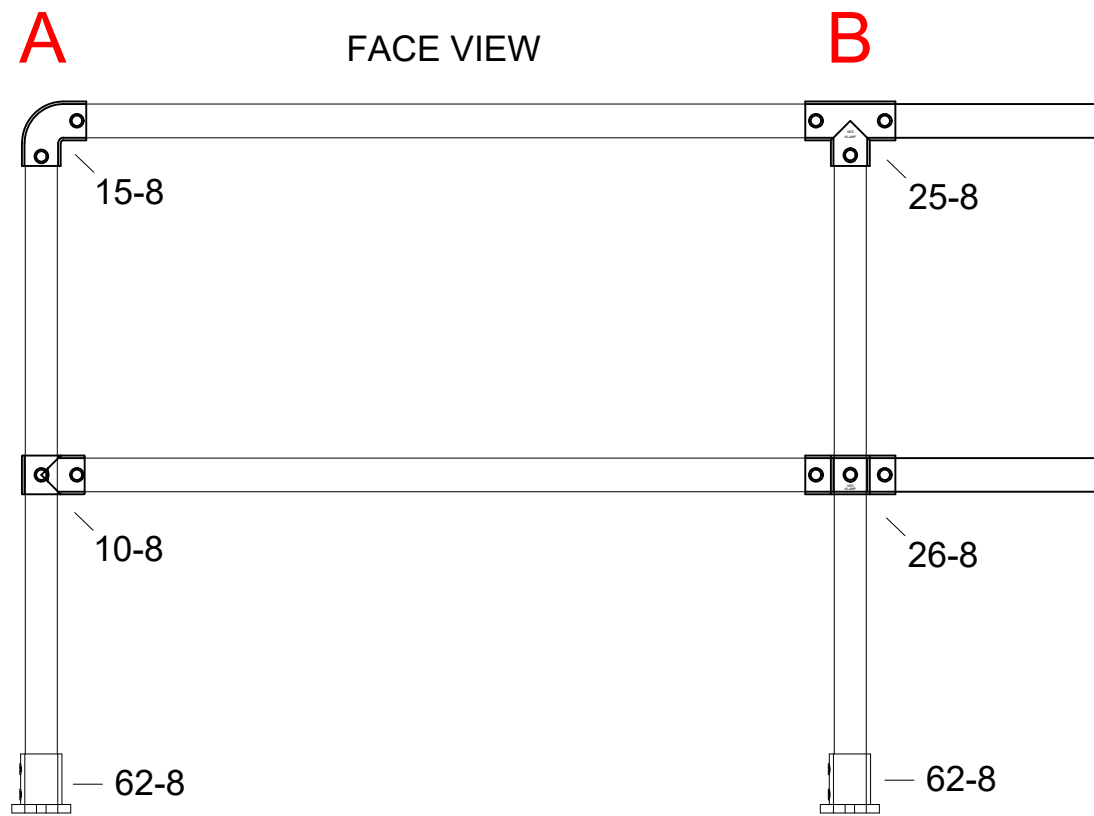

0	00-00-00	ORIGINAL ISSUE
REV.	DATE	DESCRIPTION
REVISION & SUBMITTAL RECORD		
Safety Rail Source		
2570 Boulevard of the Gen. #200, Norristown, PA 19403		
PHONE: 610-539-9535 FAX: 610-539-1630		
WEBSITE WWW.SAFETYRAILSOURCE.COM		

Company Name - Job #

LAYOUT 1

DWN. BY	
EMD	
CHK'D BY	
SCALE	REV.
NONE	0
DWG. No.	
N/A	

All Information Contained in this drawing is the sole property of Safety Rail Source. Any reproduction is prohibited without the written consent of Safety Rail Source.

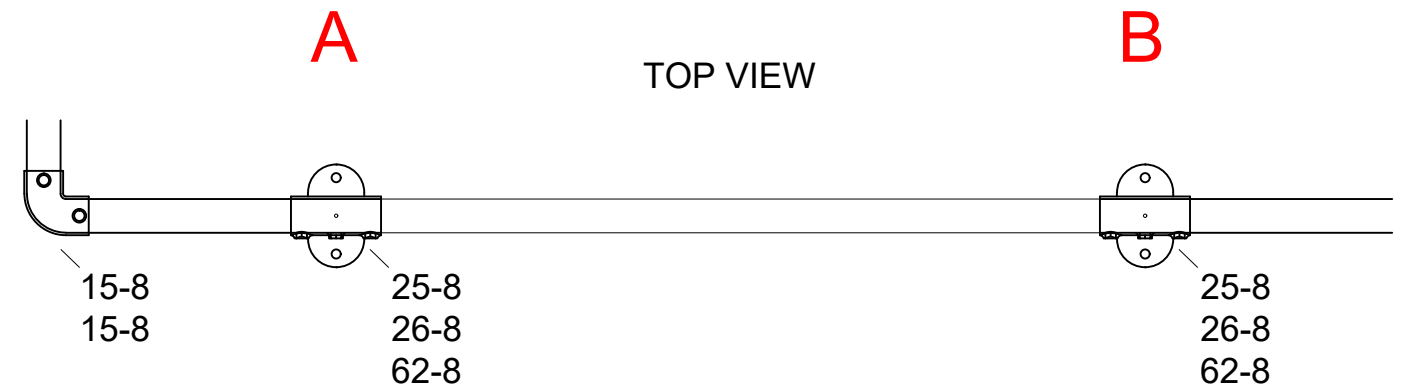
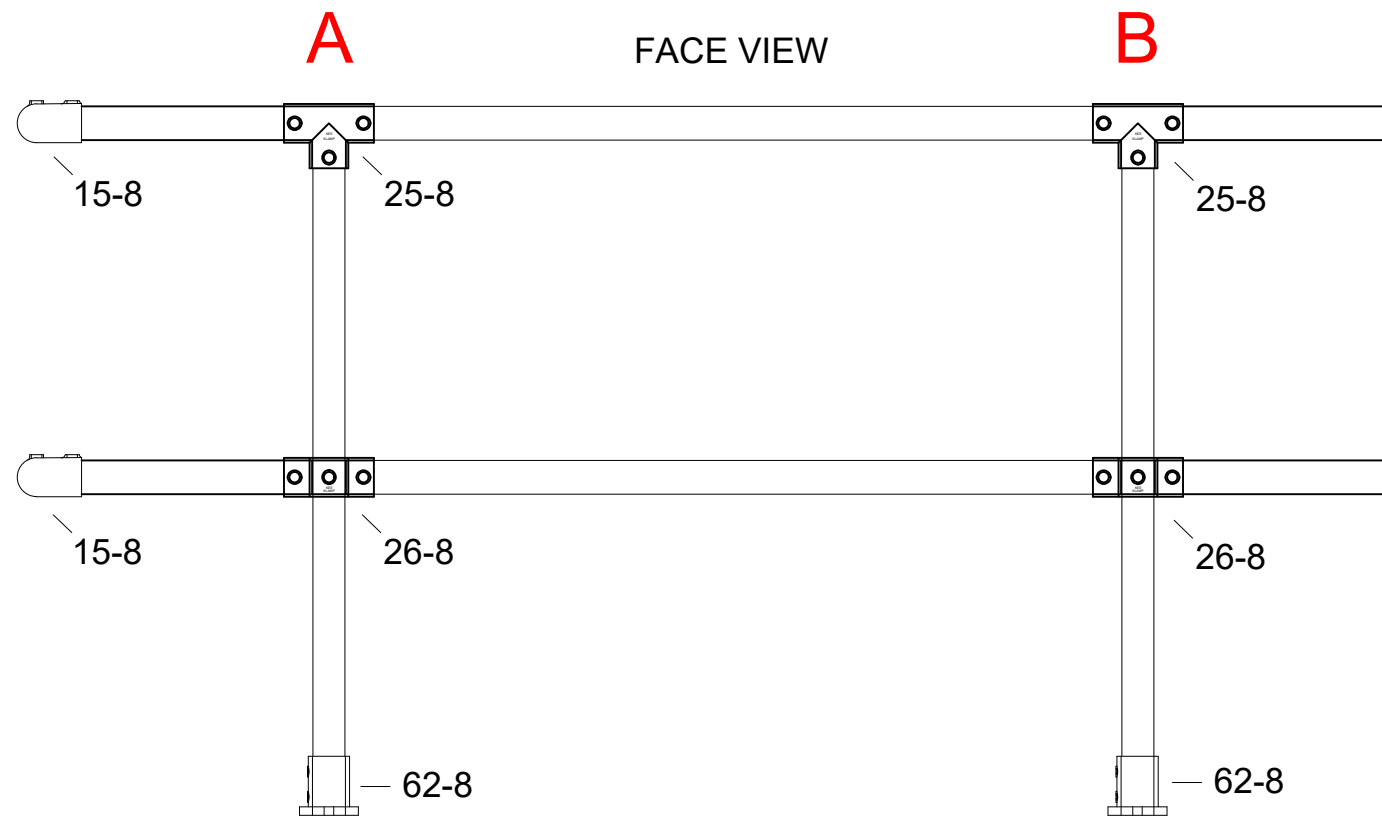

0	00-00-00	ORIGINAL ISSUE
REV.	DATE	DESCRIPTION
REVISION & SUBMITTAL RECORD		
Safety Rail Source		
2570 Boulevard of the Gen. #200, Norristown, PA 19403		
PHONE: 610-539-9535 FAX: 610-539-1630		
WEBSITE WWW.SAFETYRAILSOURCE.COM		

Company Name - Job #
LAYOUT 2

DWN. BY	EMD
CHK'D BY	
SCALE	NONE
REV.	0
DWG. No.	N/A

All Information Contained in this drawing is the sole property of Safety Rail Source. Any reproduction is prohibited without the written consent of Safety Rail Source.

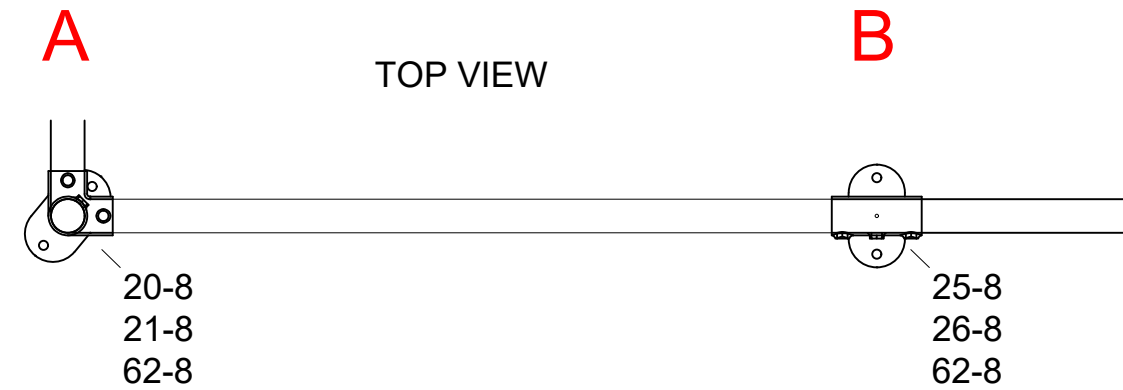
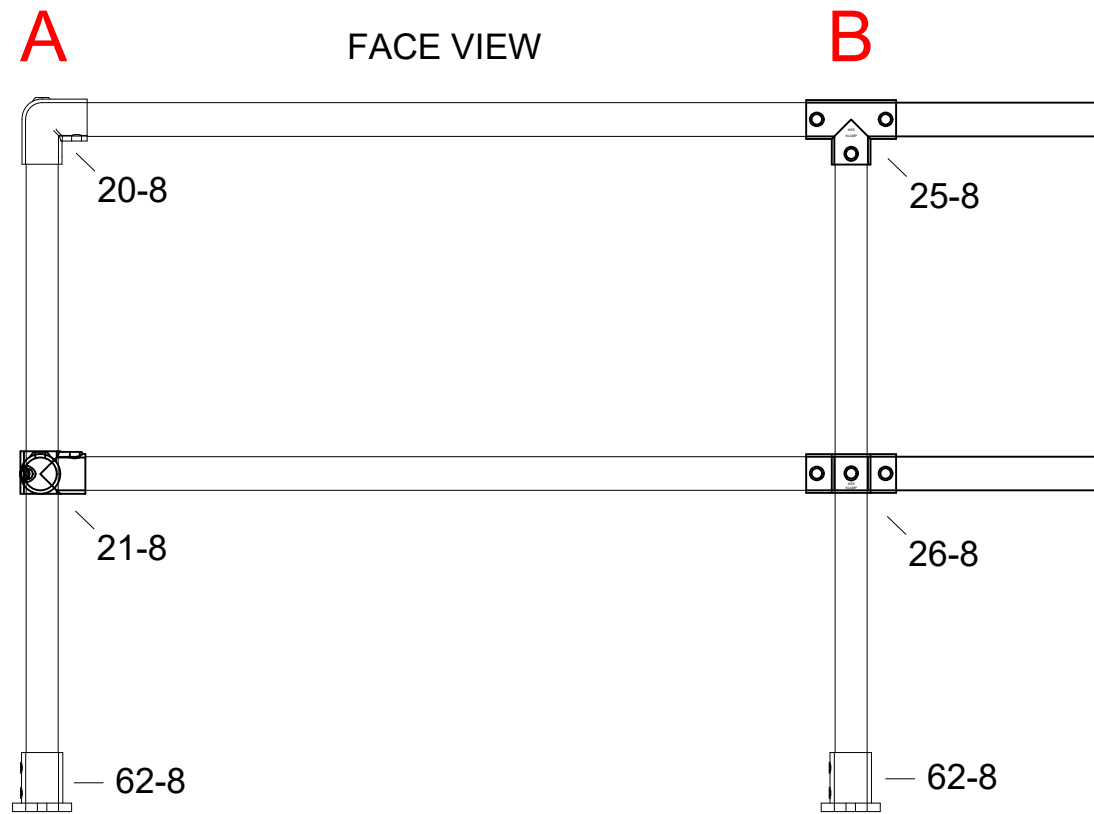

0	00-00-00	ORIGINAL ISSUE
REV.	DATE	DESCRIPTION
REVISION & SUBMITTAL RECORD		
Safety Rail Source		
2570 Boulevard of the Gen. #200, Norristown, PA 19403		
PHONE: 610-539-9535 FAX: 610-539-1630		
WEBSITE WWW.SAFETYRAILSOURCE.COM		

Company Name - Job #
LAYOUT 3

DWN. BY	EMD
CHK'D BY	
SCALE	NONE
REV.	0
DWG. No.	N/A

All Information Contained in this drawing is the sole property of Safety Rail Source. Any reproduction is prohibited without the written consent of Safety Rail Source.

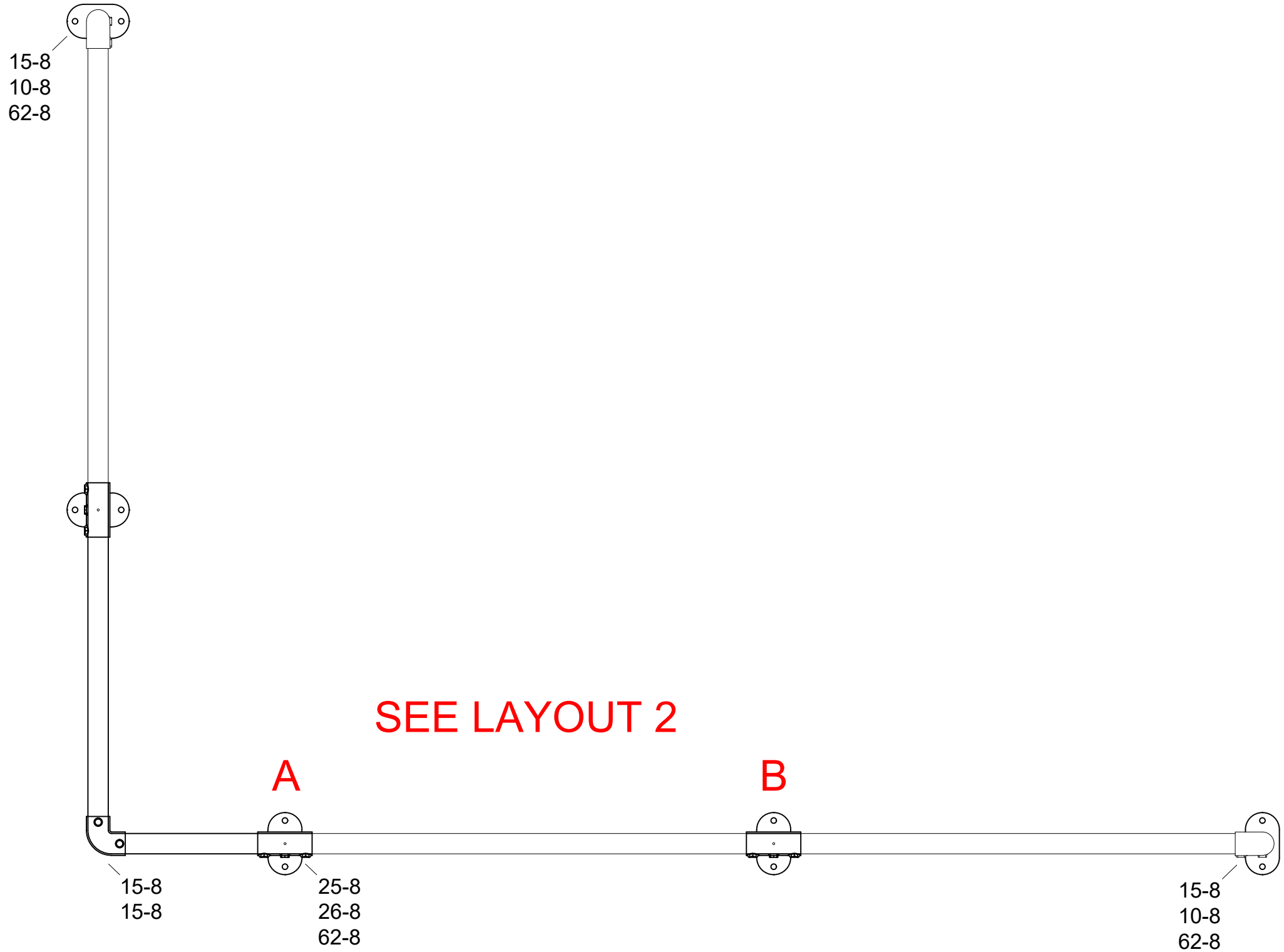

SEE LAYOUT 2

0	00-00-00	ORIGINAL ISSUE
REV.	DATE	DESCRIPTION
REVISION & SUBMITTAL RECORD		
Safety Rail Source		
2570 Boulevard of the Gen. #200, Norristown, PA 19403		
PHONE: 610-539-9535 FAX: 610-539-1630		
WEBSITE WWW.SAFETYRAILSOURCE.COM		

Company Name - Job #
LAYOUT 4

DWN. BY	EMD
CHK'D BY	
SCALE	REV.
NONE	0
DWG. No.	N/A

All Information Contained in this drawing is the sole property of Safety Rail Source. Any reproduction is prohibited without the written consent of Safety Rail Source.

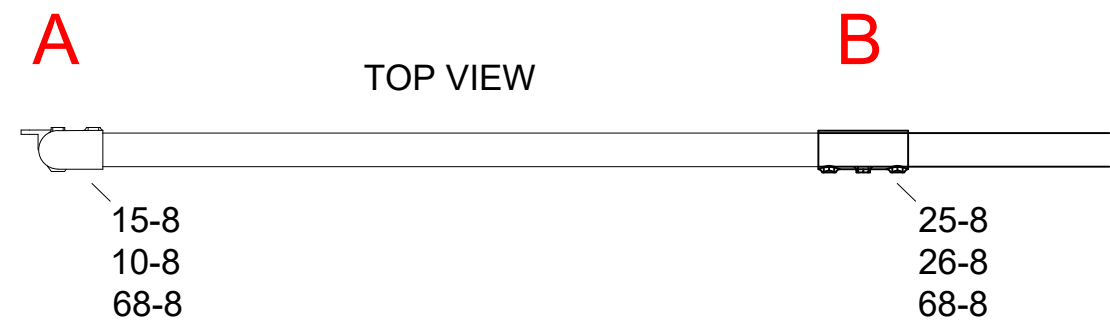
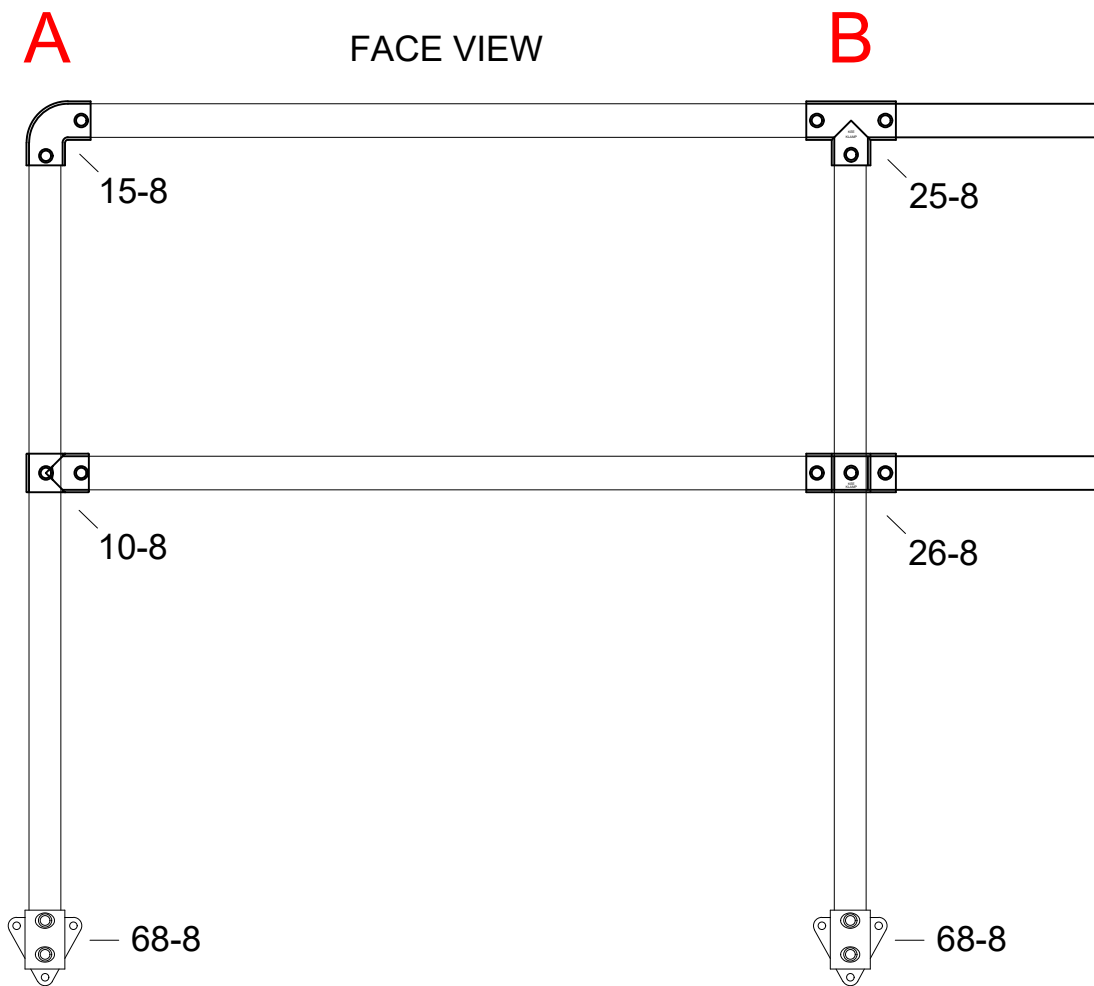

0	00-00-00	ORIGINAL ISSUE
REV.	DATE	DESCRIPTION
REVISION & SUBMITTAL RECORD		
Safety Rail Source		
2570 Boulevard of the Gen. #200, Norristown, PA 19403 PHONE: 610-539-9535 FAX: 610-539-1630 WEBSITE WWW.SAFETYRAILSOURCE.COM		

Company Name - Job #
LAYOUT 5

DWN. BY	EMD
CHK'D BY	
SCALE	NONE
REV.	0
DWG. No.	N/A

All Information Contained in this drawing is the sole property of Safety Rail Source. Any reproduction is prohibited without the written consent of Safety Rail Source.

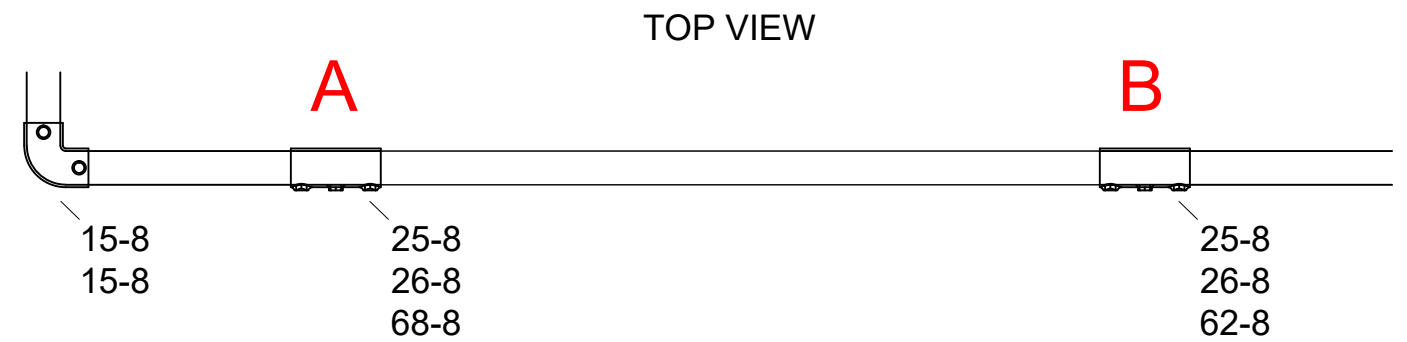
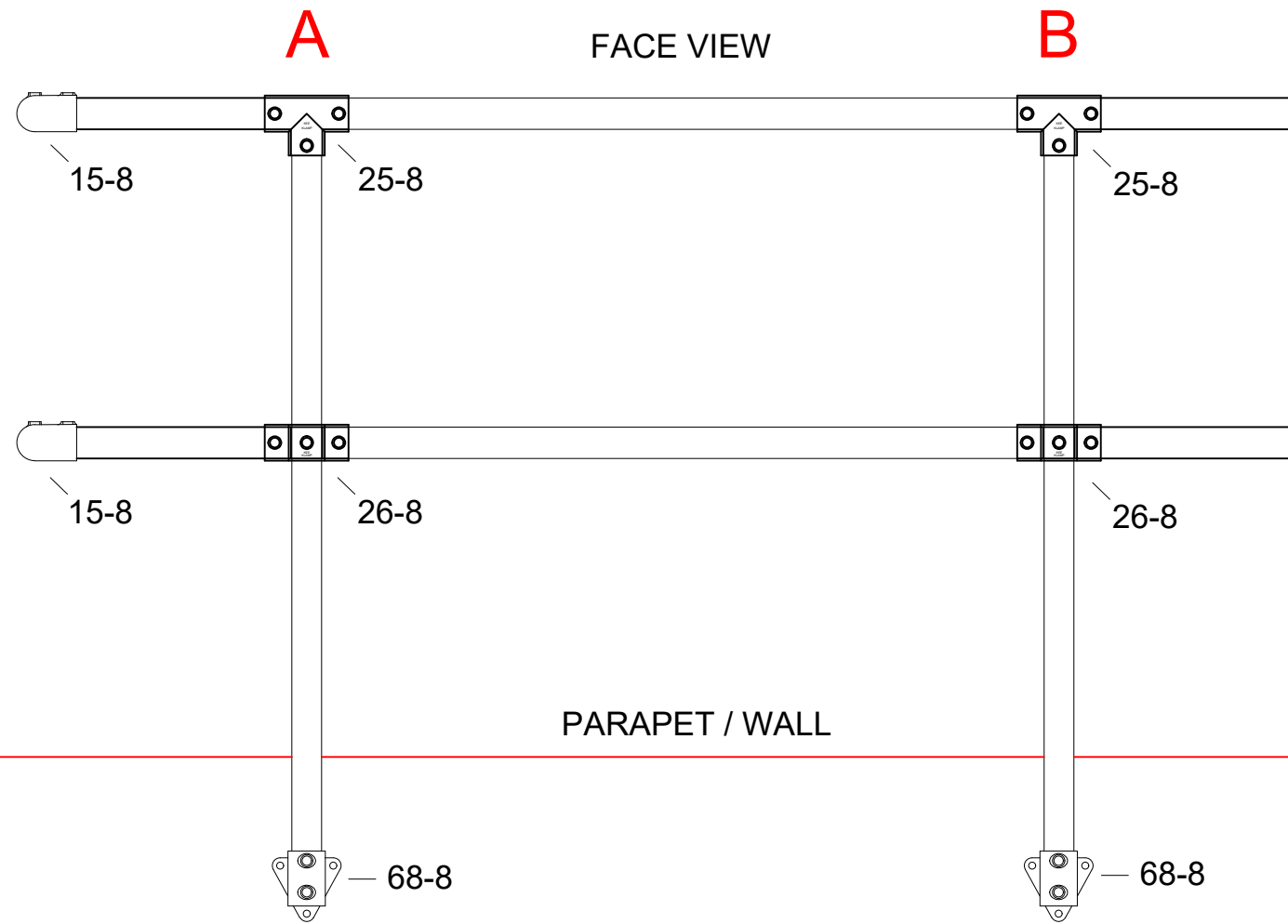

0	00-00-00	ORIGINAL ISSUE
REV.	DATE	DESCRIPTION
REVISION & SUBMITTAL RECORD		
Safety Rail Source		
2570 Boulevard of the Gen. #200, Norristown, PA 19403		
PHONE: 610-539-9535 FAX: 610-539-1630		
WEBSITE WWW.SAFETYRAILSOURCE.COM		

Company Name - Job #

LAYOUT 6

DWN. BY
EMD

CHK'D BY

SCALE
NONE

REV.
0

DWG. No.
N/A

All Information Contained in this drawing is the sole property of Safety Rail Source. Any reproduction is prohibited without the written consent of Safety Rail Source.

15-8
10-8
68-8

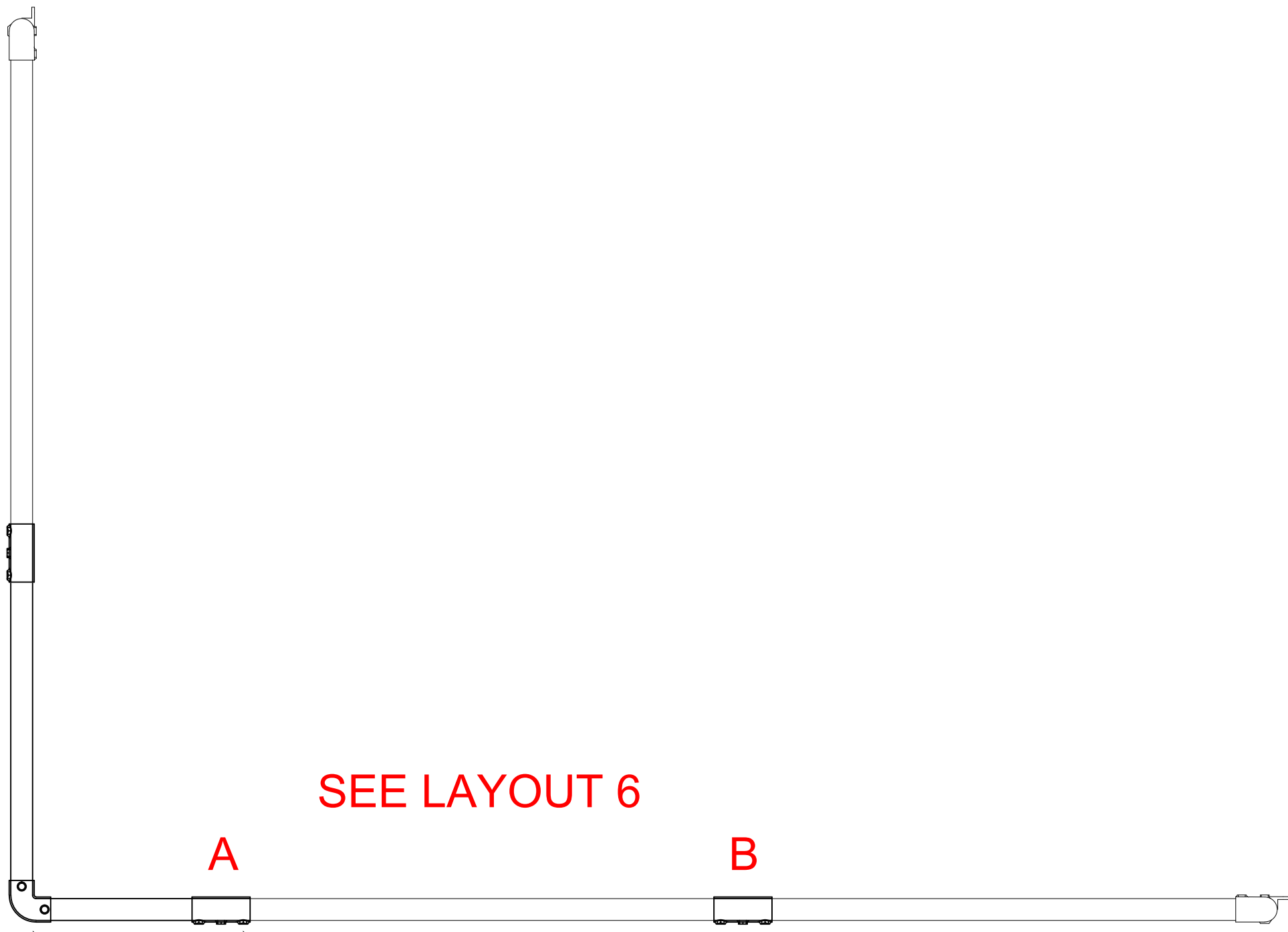

15-8
15-8

25-8
26-8
68-8

15-8
10-8
68-8

SEE LAYOUT 6

A

B

REV.	DATE	DESCRIPTION
0	00-00-00	ORIGINAL ISSUE
REVISION & SUBMITTAL RECORD		
Safety Rail Source		
2570 Boulevard of the Gen. #200, Norristown, PA 19403 PHONE: 610-539-9535 FAX: 610-539-1630 WEBSITE WWW.SAFETYRAILSOURCE.COM		

Company Name - Job #
LAYOUT 7

DWN. BY	EMD
CHK'D BY	
SCALE	NONE
REV.	0
DWG. No.	N/A

All Information Contained in this drawing is the sole property of Safety Rail Source. Any reproduction is prohibited without the written consent of Safety Rail Source.