

TECHNICAL NOTICE

Fixed Ladder Range

DOC303_11 June 2023

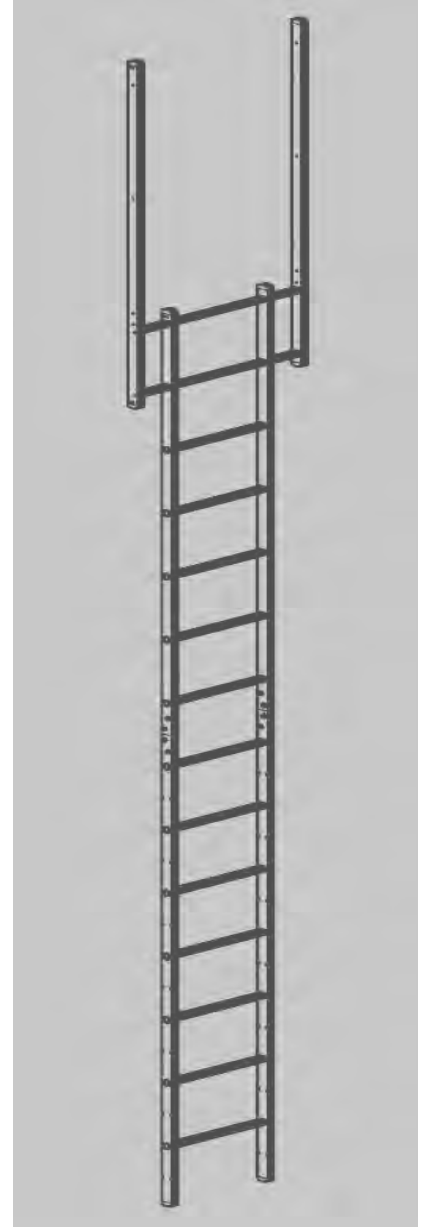
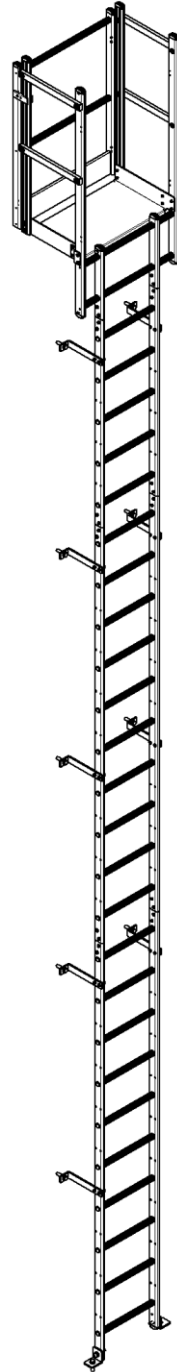

FALLPROTEC
Height Safety Products



SafetyRail
SOURCE®

1. GENERAL INFORMATION

This range is designed specifically for industrial buildings and facilities.

It's quick to set up due to the small number of components.

Its kit design allows the safety cage ladder to be given the ideal geometry according to the host structure.

This technical notice certifies the values of the characteristics stated in its compliance with standards OSHA1910, EN 85-016 and EN 14122-4.

2. DESCRIPTION OF THE COMPONENTS

Ladder: is made up of 2 aluminum profiles with a 2.55 x 1" (65 x 25mm) oblong cross-section on which are crimped anti-slip ribbed aluminum rungs with a 1 x 1" (25 x 25mm) cross-section. The ladders are pre-drilled at each end for coupling.

Useful width of the ladder: 16.15" (410 mm) – distance between rungs: 11" (280 mm)

The ladders are not limited in length, but to facilitate their transport they are divided into several elements of a maximum length of 110.23" (2800mm).

Wall brackets: Drill a \varnothing 3/8" (10 mm) hole into the building facade. Insert \varnothing 3/8" (10 mm) fixing.

The fixing will pass through the bracket which has a 1/2" (12mm) hole.

Tighten the bolt of the wall bracket.

The bracket is connected to the ladder by means of aluminum strap or bolts.

It's essential to check the strength of the anchor points before starting the installation.

A standard 7.8" (200mm) length bracket is fitted to the ladder's profiles.

Adjustable brackets are also available for a range between 6" and 11.8" (150 to 300mm).

Install a pair of bracket every 110.23" (2800mm) maximum.

The bottom element is fixed with minimum 4 brackets. (Four wall brackets or two wall brackets and two floor brackets.)

It is recommended to have the ladder touch the floor, so all vertical forces are transmitted to the floor. If that is not possible, the installer shall put two pairs of brackets distant by max. 4' (1220mm) at the very top of the ladder.

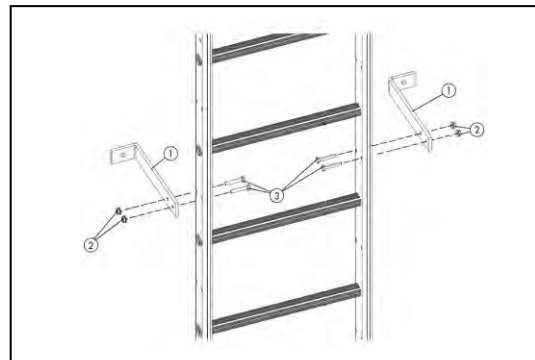
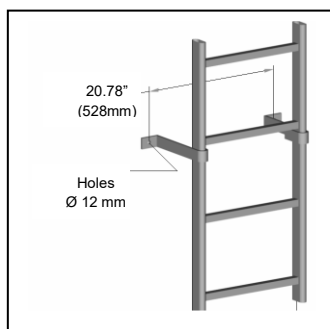

Example of bracket

1 = 7.8" (200mm)

2 = Nuts 5/16" (8mm)

3 = Bolt \varnothing 5/16", Length 1.77" (45mm)

Landing platform: Several types of landing platforms have been created:

- Parapet landing measuring 15" (400mm), 23.6" (600mm), 31.4" (800mm), 39.3" (1000mm), 47" (1200mm) wide and placed at the same height as the last ladder rung
- Right ou left side exit platform measuring 39.3 x 39.3" (1000 x 1 000mm) or 59x39.3" (1500 x 1 000 mm). The ladder extends 43.3" (1100 mm).
- 7.8" (200 mm) landing platform fitted on front exit

Landing platform is composed of a handrail, an intermediary rail and à 5.9" (150mm) high baseboard, in accordance with the standard.

To ensure total security, gates opening to the left or right can be installed on:

- Parapet landing
- Wide exit
- Landing step
- Side exit platform

Load capacity on platform: 331 lbs (150kg)

Type of exit:

Open-end exit:

The ladder stops on the same level than the platform or the roof. The ladder hinges continue for 43.3" (1100mm)

Exit through closed skydome:

When the fixed ladder ends below the trapdoor, it must be equipped with retractable pole (3 fastening types available).

Side exit:

Exit to the right or the left. Ladder continues over 59" (1500 mm), so the end user can climb and exit the ladder.

Anti-intrusion door:

Anti-intrusion doors are recommended to restrict the access to the roof or any dangerous area. The anti-intrusion door is mandatory if the ladder is freely accessible by the public.

3. ALUMINUM CHARACTERISTICS

All fixed ladder components are made of 6000 series aluminum alloys. Aluminum alloy is classified by and complies with NF EN 573-3. Mechanical properties comply with NF EN 755-2.

Alloy used for ladder rungs and bendable 40x8 flat bar: 6060 T5 R19

%	Si	Fe	Cu	Mn	Mg	Cr	Zn	Ti
Mini	0.30	0.10			0.35			
Maxi	0.60	0.30	0.10	0.10	0.60	0.05	0.15	0.10
+/-	0.20	0.03	0.01	0.01	0.02	0.01	0.20	0.01

Mechanical properties of alloy

Elastic limit R0.2% [N/mm²] 150 min.

Tensile strength [N/mm²] 190 min.

Elongation [min.] 10 min.

Alloy used for ladder stiles: 6106 T6 R24

%	Si	Fe	Cu	Mn	Mg	Cr	Zn	Ti
Mini	0.30			0.05	0.40			
Maxi	0.60	0.35	0.25	0.20	0.80	0.20	0.10	-
+/-	0.20	0.03	0.01	0.01	0.02	0.01	0.20	-

Mechanical properties of alloy

Elastic limit R0.2% [N/mm²] 195 min.

Tensile strength [N/mm²] 240 min.

Elongation [min.] 10 min.

This alloy was chosen for the following properties:

Weldability: very good

Formability for T5 temper: very good

Natural resistance: to atmospheric conditions: very good
to seawater: good
to anodizing: very good

Fire resistance:

Aluminum alloys are classified "MO", meaning that they are non-combustible.

In a fire, aluminum and its alloys exhibit the following behavior:







Metal is deformed due to the constraints resulting from its expansion under high temperature.

Metal melts at 1200 F° (650°C), without catching fire.



It has been demonstrated that, even at very high temperatures and under oxygen pressure, liquid aluminum does not catch on fire. It therefore does not contribute to the spread of fire.





In case of temperature above 400F°, the ladder must be thoroughly inspected by the installer to verify the integrity of the components. The resistance of aluminum alloy can be affected by high temperatures.

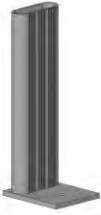
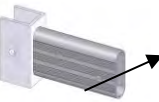

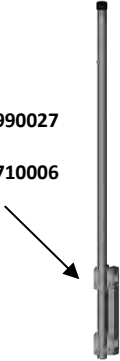

4. COMPONENT LIST

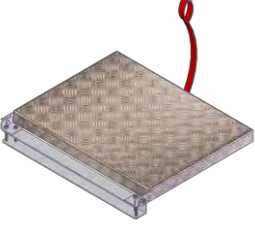
Reference	Description	Image	Component characteristics: Fixed ladder Kit
A859352000 A859353000 A859356000	Vertical bars length 2000 length 3000 length 6000		Safety cage ladder is composed of hoops and vertical bar fastend together on 5 points using A2TH M8 bolts and nuts. Hoops and vertical bars have been designed so that openings are no larger than 0,4 m ² .
F600200004	Fixation set for I-beams		These accessories ensure that ladder is rigid and guarantee maximum safety when ladder is used under normal conditions.
LDV023	Fixation set for cladding		Special bracket for cladding is delivered with 16 self drilling screws and a sealing tape.
F600200005	Floor mount bracket	 Stainless steel screws M8 x 45 – Ref. A710880045 Brake nut M8 – Ref. A710890007	Floor mount bracket fastens ladder to the ground. Directly fastened to the outside of ladder stiles. Holes - 8,5 mm <u>Material:</u> 80x80x8 angle Hardware included, delivered pre-assembled. Tightening 10 Nm
F600200008	Vertical bar connection	 Stainless screws A2TH M8 x 20 – Ref. A710880020 - Bevelled nut M8 – Ref. A710740026	Vertical bar splice is designed to connect two vertical bars. Hardware included, delivered pre-assembled.
F600200123	Wall bracket, length 2.9" (75mm)	 Stainless screws M8 x 45 – Ref. A710880035 Nut M8 – Ref. A710890007	Allows the ladder to be fixed to a platform at the top (avoids the need for a landing step). Hardware included, delivered pre-assembled.
F600200121	Wall bracket Adjustable from 5.9" to 11.8" (150 to 300 mm)	 Stainless steel screws M8 x 38 - Ref. A710880035 Nut M8 - Ref. A710890007	Fastened to the ladder profil and clamping. Check the reliability of the anchor points on the building. Drill Ø 3/8" (10 mm) hole for 3/8" (10 mm anchor plug). <u>Material:</u> 40 x 8 flat bar Hardware included, delivered pre-assembled Tightening 160 lbf (18 Nm)
F600200125	Straight wall bracket Length 2.9" (200)	 Stainless steel screws M8 x 45 - Ref. A710880045 Nut M8 - Ref. A710950008	Fastened to the ladder profil and locking by screwing directly onto the profil. Hardware included Tightening 88 lbf (10 Nm)

Stainless steel screws M8 x 25 - Ref. A710880025



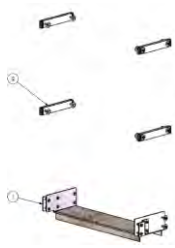

F600200120	Wall bracket Length 2.9" (200)	<p>Nut M8 - Ref. A710890007</p> 	<p>Fastened to the ladder profiles and clamping. Maximum distance between 2 wall brackets: 110" (2800 mm). Minimum distance between wall and backside of rung: 7" (178 mm) Check the reliability of the host structure. Drill Ø 3/8" hole (10 mm) for the anchor (anchor not included). Hardware included, delivered pre-assembled Tightening 160 lbf (18 Nm)</p>
F600200003	Adjustable foot for ladder	<p>Stainless steel screws M8 x 45 ref. A710880045 Brake nut M8 - ref. A710890007</p> 	<p>Fastened to the ladder profiles and clamping Allows to adjust ladder base on the uneven ground. Hardware included Tightening 88 lbf (10 Nm)</p>
Reference	Description	Image	Component characteristics: safety cage ladder Kit
F600200034	Splice + U welded	 <p>Stainless steel screws M8x45 ref. A710880045 Brake nut M8 ref. A710890007</p>	<p>Aluminum piece to be fastened on ladder Hardware included</p>
F600100033	Splice for Fixed ladder profile	<p>Stainless steel screws M8x40 ref. A710880040 Brake nut M8 ref. A710890007</p> 	<p>Complete junction designed to join 2 ladders <u>Material:</u> oblong profile, thickness 1.6 mm Hardware included, , delivered pre-assembled Tightening 88 lbf (10 Nm)</p>
F600100017	Alu retractable pole fastened to ladder rungs	<p>Stirrup ref. A710990027 Nut H M6 ref. A710710006</p> 	<p>Aluminum poles with different fastening method Reference F600200017: makes getting off ladder easier, for example when accessing roof hatch Brackets to support the ladder rungs with stirrups Reference F600200018: fastened to wall Bracket for wall mounting Reference F600200019: fastened to ladder stile</p>

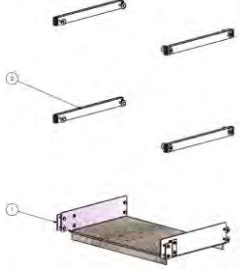
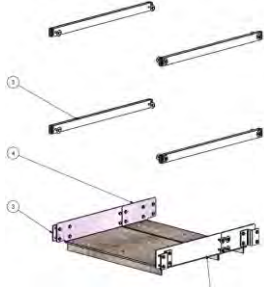
<p>F600100018</p>	<p>Alu pole fastened to wall</p>		
<p>F600100019</p>	<p>Alu pole fastened to ladder stile</p>		<p>Aluminum poles with different fastening method</p> <p>Reference F600200017: makes getting off ladder easier, for exemple when accessing roof hatch Brackets to support the ladder rungs with stirrups</p> <p>Reference F600200018: fastened to wall Bracket for wall mounting</p> <p>Reference F600200019: fastened to ladder stile</p>
<p>F600200089</p>	<p>Foldable rest platform</p>		<p>Foldable platform integrated into the safety cage ladder This is a technical solution designed by FORTAL to use when a ladder change-over is not possible. Platform opens upwards when red strap is pulled, allowing user to pass through safely Platform closes automatically after user has passed through. Hardware included, delivered pre-assembled</p>
<p>A750016525</p>	<p>Grey foot pad 2.5x1" (65 x 25mm)</p>		<p>Foot pad with anti-UV treatment for ladder profilis 2.5x1" (65 x 25mm)</p>

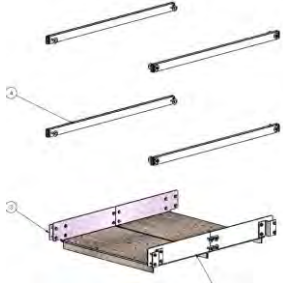
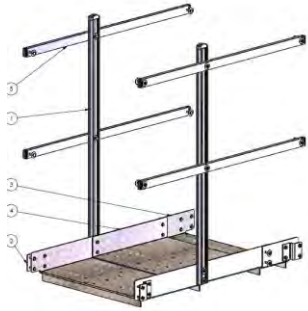
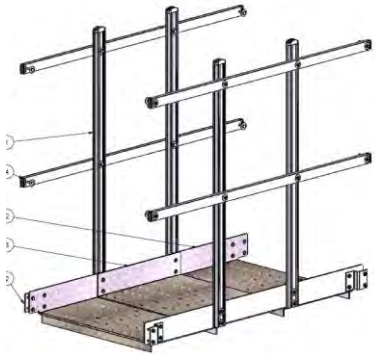



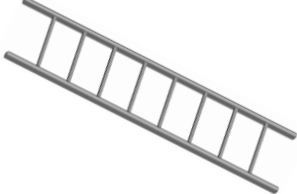

F600800045	Wide exit		
F600100535	Extended wide exit		27.5" (700 mm) wide exit designed for the top section of the ladder Two couplers (Ref. F600100033) are required to fasten with ladder
F600200199	Pole for safety gate		Vertical poles are used to fasten safety gate to ladder. Two poles are required per safety gate
Reference	Description	Image	Component characteristics: safety cage ladder Kit
F600100041	Aluminum safety gate for wide exit and parapet landing	<p>8 M5 x 35 screws Ref. A710400035 1 M5 x 50 screw Ref. A710400050 9 M5 brake nut Ref. A710710004</p> 	<p>Exit onto arrival area must include a safety gate which satisfies the following requirements:</p> <ul style="list-style-type: none"> - easy to open - closes automatically using spring-loaded hinges <p>Hardware included, delivered pre-assembled (Provide 2 poles)</p>
F600650200	Landing step 200 + guardrail 200		<p>7.9" (200 mm) landing step used to bridge the gap between the safety cage ladder and the platform</p> <p>Hardware included</p>

<p>F600650400</p>	<p>Landing step 15.7" + guardrail 15.7"</p>		<p>15.7" (400 mm) landing step used to bridge the gap between the safety cage ladder and the platform Hardware included</p>
<p>F600650600</p>	<p>Parapet landing 23.6" + guardrail 23.6"</p>		<p>For crossing of a parapet landing of width 100 to 200 mm. Hardware included</p>

Reference	Description	Image	Component characteristics: safety cage ladder Kit
F600650800	Parapet landing 31.4" + guardrail 31.4"(800mm)		For crossing of a parapet landing of width 7.9" 15.7" (200 to 400 mm.) Hardware included
F600651000	Parapet landing 39.3" + guardrail 39.3"(1000mm)		For crossing of a parapet landing of width 15.7" to 23.6" (400 to 600 mm). Hardware included
F600651200	Parapet landing 47.2" + guardrail 47.2"		For crossing of a parapet landing of width 23.6" to 31.4" (600 to 800 mm.) Hardware included

Reference	Description	Image	Component characteristics: safety cage ladder Kit
F030800006	Adjustable foot	<p>Stainless steel screws M8 x 20 – Ref. A710880020 Bevelled nut M8 – Ref. A710890007</p> 	<p>Adjustable foot to be fixed to parapet landing (only for low parapet landing on roof side)</p> <p>Hardware included</p>
F600200450	Side exit platform 393x39.3"		<p>Side exit platforms with guardrail and a wall fixing bracket.</p> <p>Hardware included, delivered pre-assembled</p>
F600200451	Side exit platform 1500x1000		
F600200402	Gate for side exit platform		<p>Gate for side exit platform opens to the right or to the left Automatic closing using spring-loaded hinges Rework on the guardrail post of the side exit platform</p> <p>Hardware included, delivered pre-assembled</p>
F600200400	Width adjustable gate - raw aluminum handrail		<p>Max width 39.3" (1000mm) – To adjust on site</p> <p>Delivered dismantled</p>
F600200401	Width adjustable gate - red lacquered handrail		
F600200411	Width adjustable gate - yellow lacquered handrail		
F600802800	Aluminum ladder Length 110.23 »		<p>Ladder of 110.23" (2800mm) All ladders are pre-drilled at each end for easy coupling Profiles 2.5x1.1" (65 x 25 mm) aluminum profiles with oblong cross section <u>Rungs</u> 1.1x1.1" (25x25mm) non-slip aluminum square rung Rung length:16.1" (410mm) Total width: 18.1" (460mm)</p>

--	--	--	--

Reference	Description	Image	Lower access characteristics
F600500215	Steel half door + cap		The lock must be located at a maximum height of 2 000 mm from the ground – Padlock not included. Horizontal protection placed under the hoop to prevent it from being used - Locking hatch mounted on hoop with padlock tubs - Pivoting panel mounted on hinges with padlock brackets
F600500220	Steel door + cap		Vertical protection covering the ladder over a minimum height of 1 800 mm to prevent it from being used - lower access security door mounted on hinges with padlock or lock - removable door with hooks and padlock brackets
F600700005	Aluminum lower security door		Height 1 800 mm Hinges at left or right (reversible) Padlock not included Weight: 10.70 kg
F600700010	Aluminum lower security door + cap		Height 1 800 mm Hinges at left or right (reversible) Padlock not included Weight: 12.90 kg
F600700015	Aluminum half door + cap		Height 520 mm Hinges at left or right (reversible) Padlock not included Weight: 5.10 kg
F600503001	Lateral sheet - height 3000 mm, per pair		Anti intrusion add-on accessories - Galvanized steel
F600503003	Bottom panel - height 3000 mm		

F600503005	Perforated sheet - height 1000 mm		
A600000016	Brass padlock 40 mm – steel shackle 22 mm		

5. TESTS

5.1 - Testing on fixed ladders

Ladder or its components must pass the following tests:

- Ladder strength test (see part 4.2 of EN 131-2-1993)
- Ladder bending test (see part 4.3 of EN 131-2-1993)
- Ladder lateral bending test (see part 4.4 of EN 131-2-1993)
- Rungs bending test (see part 4.6 of EN 131-2-1993)
- Rungs torsion test (see part 4.7 of EN 131-2-1993)

The tests were carried out on a ladder in accordance with the requirements of part 4.1 of EN 131-2-1993 and in the order indicated above.

The distance L to be taken into account for strength, bending and lateral bending tests must be the distance in millimetres between two consecutive anchor points on the ladder.

The acceptance criteria for the bending test (see part 4.3 of EN 131-2-1993) must be modified as follows: the maximum permissible deflection under load must be less than $5 \times L \cdot 10^{-6}$ mm, but not more than 50 mm.

5.2 - Testing on safety cage ladder

The hoop must be fixed on the ladder.

For the hoops, a preload (FPL) of 200 N must be applied vertically at the worst point. The preload should be spread over three horizontal hoops for 1 min.

The position of the lowest hoop of the ladder, after application of the preload, must be taken as the reference position for carrying out the test with a test load (FT) of 1,000 N.

The permissible permanent deformation measured at the point of application of the load must be less than 10 mm..

For the profiles, a simulated load (FH) of 500 N must be applied horizontally at the most unfavourable point. The simulated load (FH) can be distributed over three profiles. The permissible permanent deformation, measured at the point of application of the load, is equal to a maximum of 10 mm. Test ladders showing permanent deformation must not be put into service.

6. SAFETY TIPS

The compliance of the fixed ladder with the requirements of OSHA 1910 can only be guaranteed if all the components have been supplied by FALLPROTEC and if the assembly instructions have been duly followed. If these conditions are not respected, FALLPROTEC cannot be held responsible for any proven non-conformity of the ladder.

Distance between departure area and first rung $\leq 11"$ (280mm)

Top rung positioned must be flush with the level of the arrival platform or the parapet.

Space between the ladder and the fixed parts of the surrounding area of the access:

It must be :

- No obstacle should be placed less than 3' from the ladder.
- At least 7" compared to the back of the rungs.

Guardrails:

Guardrails are required to protect against the risk of falling from height from the arrival and departure areas and from intermediate landings, they must comply with the requirements applicable to guardrails in accordance with standard OSHA1910.29 and OSHA 1926.502

Guardrails must be provided on the edges of the void on the arrival areas over a minimum length of 5' on either side of the vertical axis of the ladder or over the entire length, if this is less than 10'.

Safety gate:

Access to the finish area must be through a safety gate that does not open onto the outside of the platform.

Safe access to and exit from the top section of a fixed ladder:

Handrails must connect the ladder profiles to the handrail of the guardrail.

These handrails must be attached to the finish area guardrails.

Important: a roof access platform with safety door and guardrail or a parapet landing step is required.

Change-over:

If the ladder is equipped with a permanent vertical lifeline, the ladder must be equipped with a rest platform if higher than 150' (45700mm).

If the ladder is not equipped with any vertical lifeline, the rest platforms must be foreseen every 50' (15200mm).

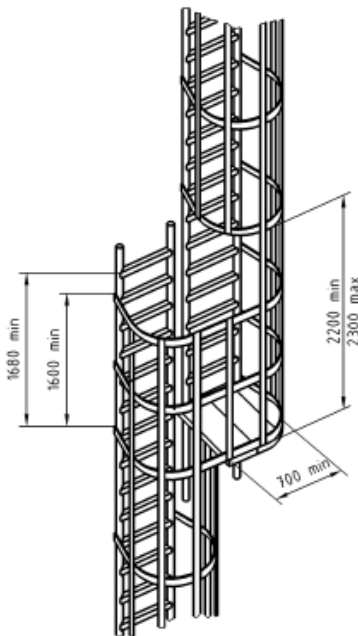

The change-over must be supplied by Fallprotec S.A.

It is a custom assembly with two ladders connected together.

7. ASSEMBLY INSTRUCTIONS

For ladder installation, it is recommended that the bottom section is in contact with the ground and that the bottom element of the ladder has at least 4 brackets. (either 2 on wall and 2 on ground OR 4 on wall)

The maximum distance between brackets for the following elements should be 9'-3" (2800mm), while the maximum distance between a splice/junction is 2' (610mm).

Additionally, the top element should be attached with 4 brackets, with a maximum spacing of 3' (915mm).

7.1 Ladder Assembly of 18'-5" (5600mm)

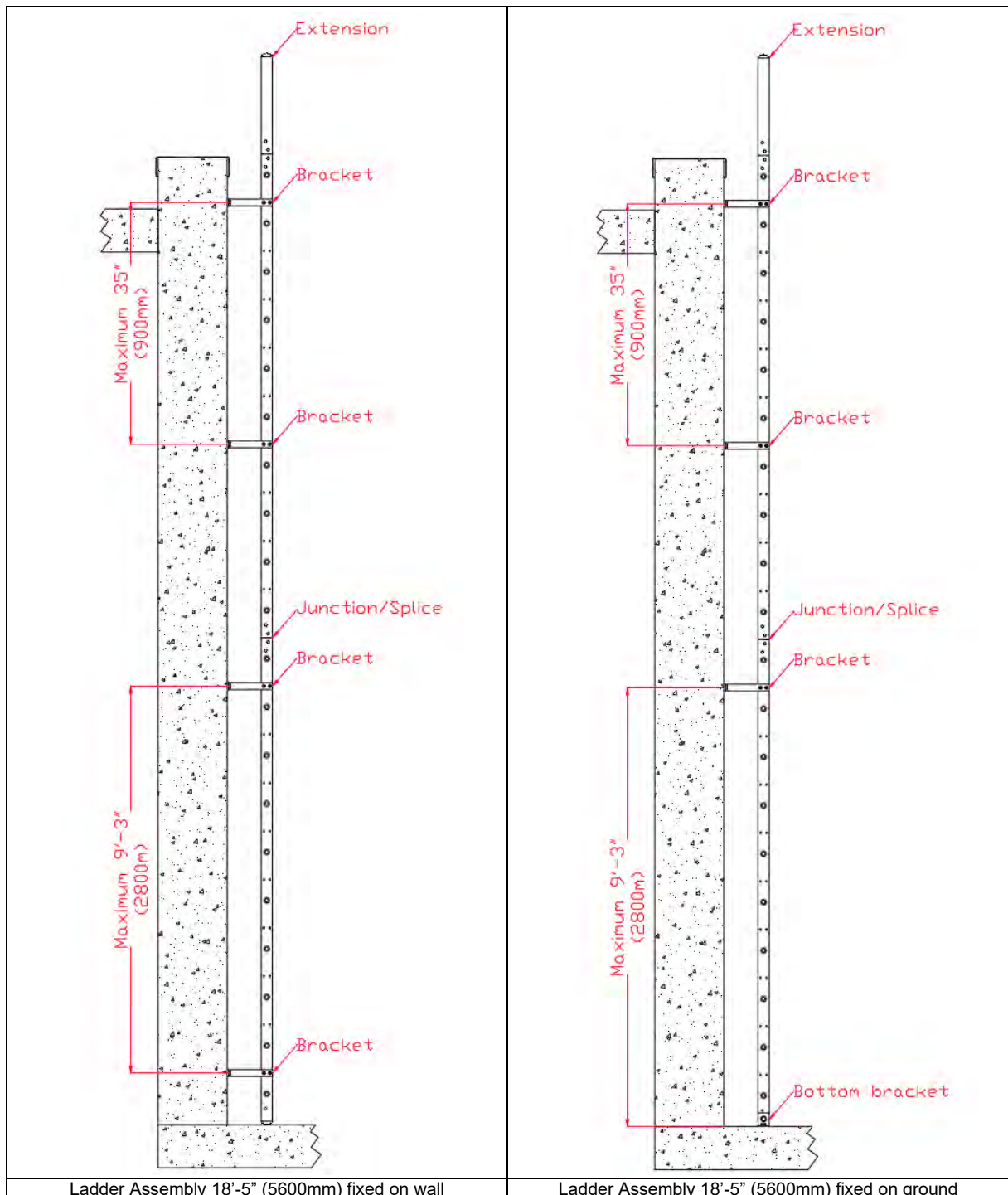

7.2 Ladder Assembly of 28'-3" with Parapet platform (8600mm)

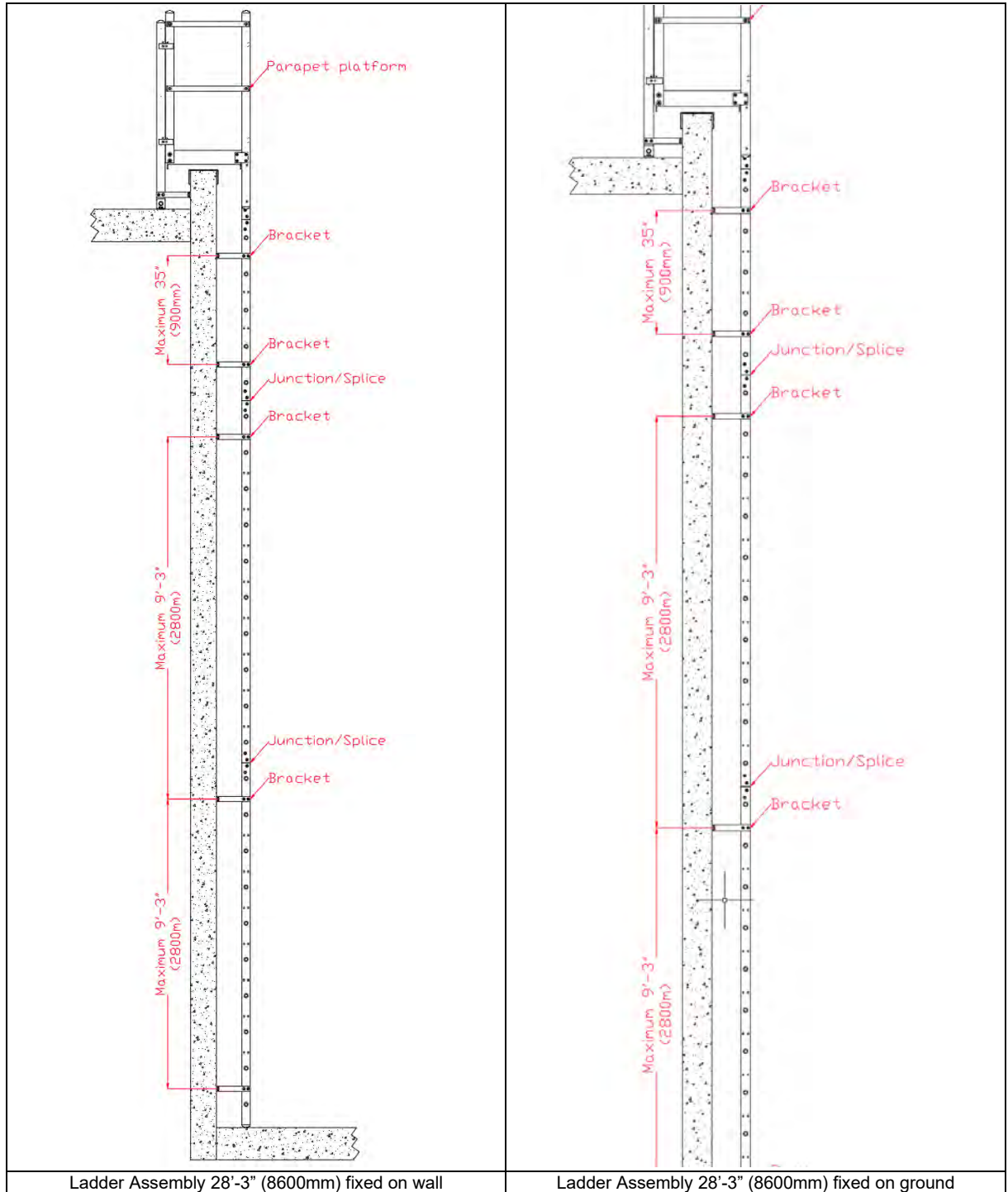

7.3 Assembly of ladderhead platform step 7.9" (200 mm):

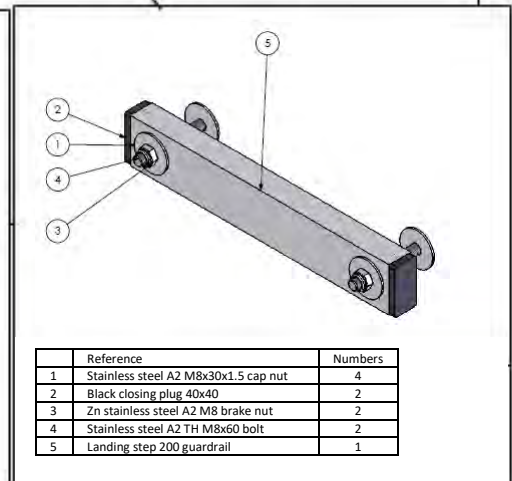
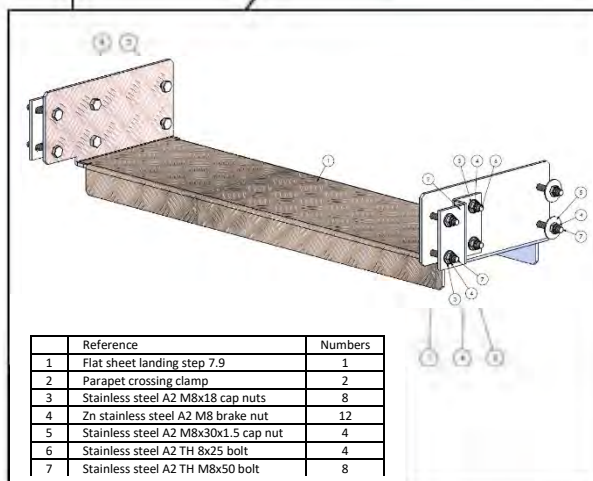
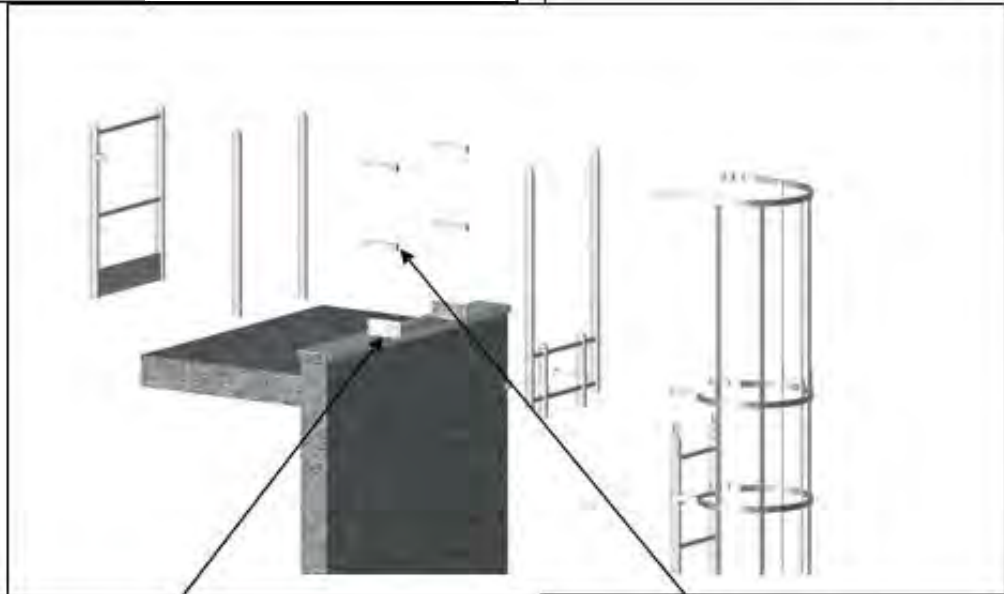
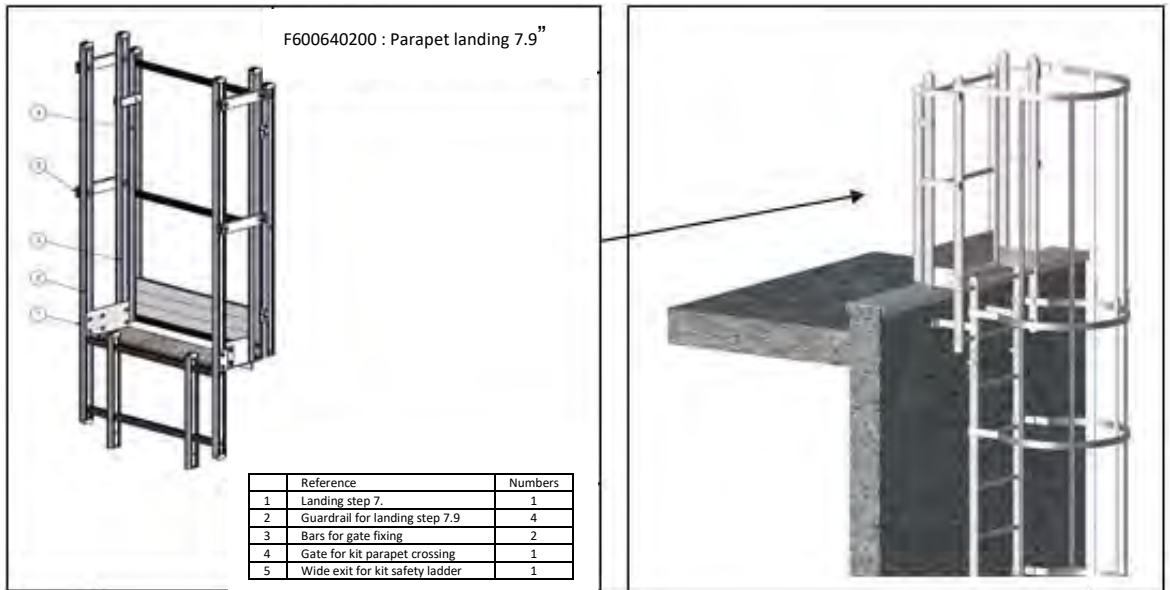

7.4 Assembly of ladderhead platform step 15.7" (400 mm):

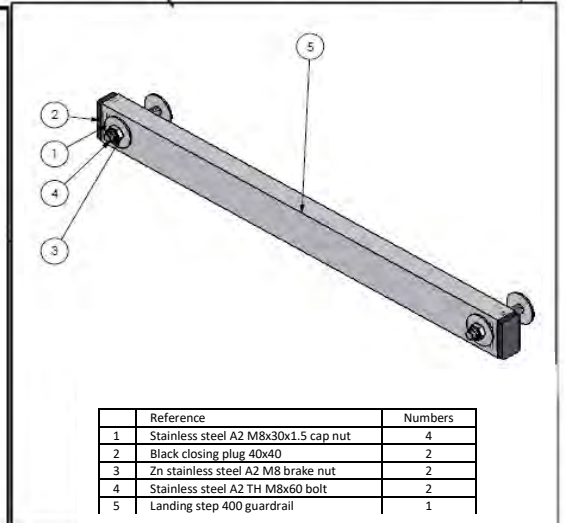
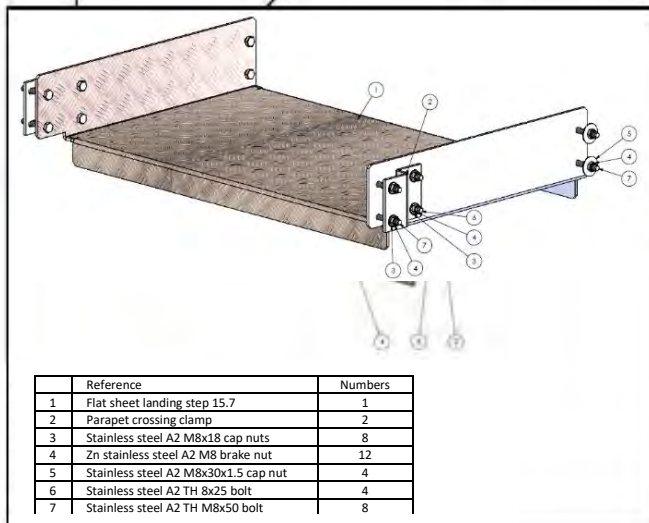
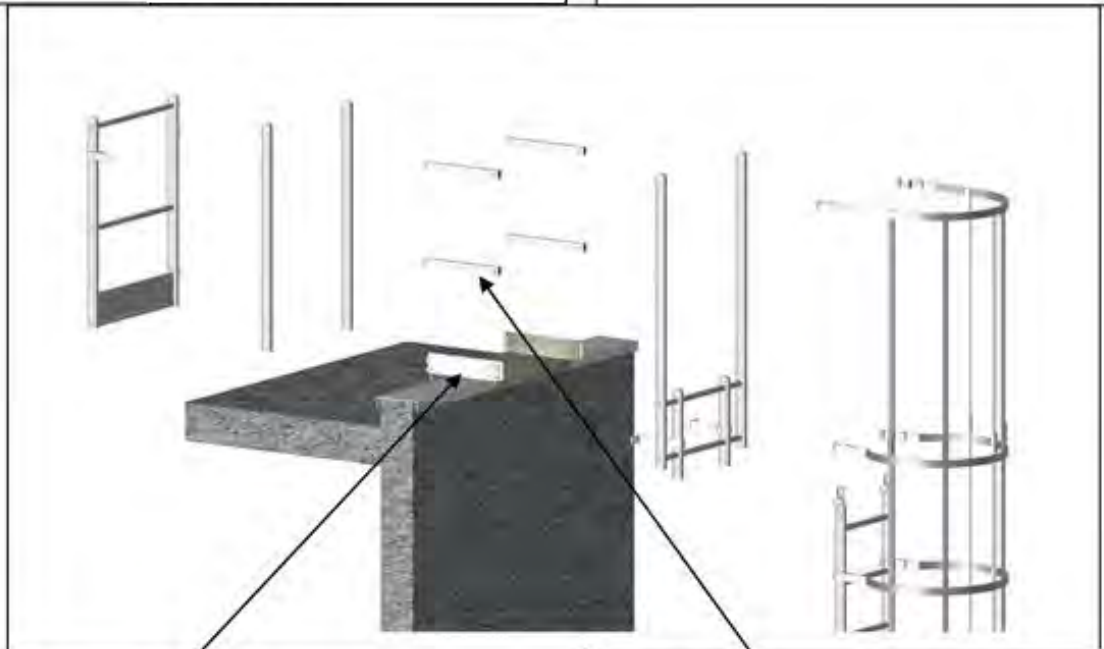
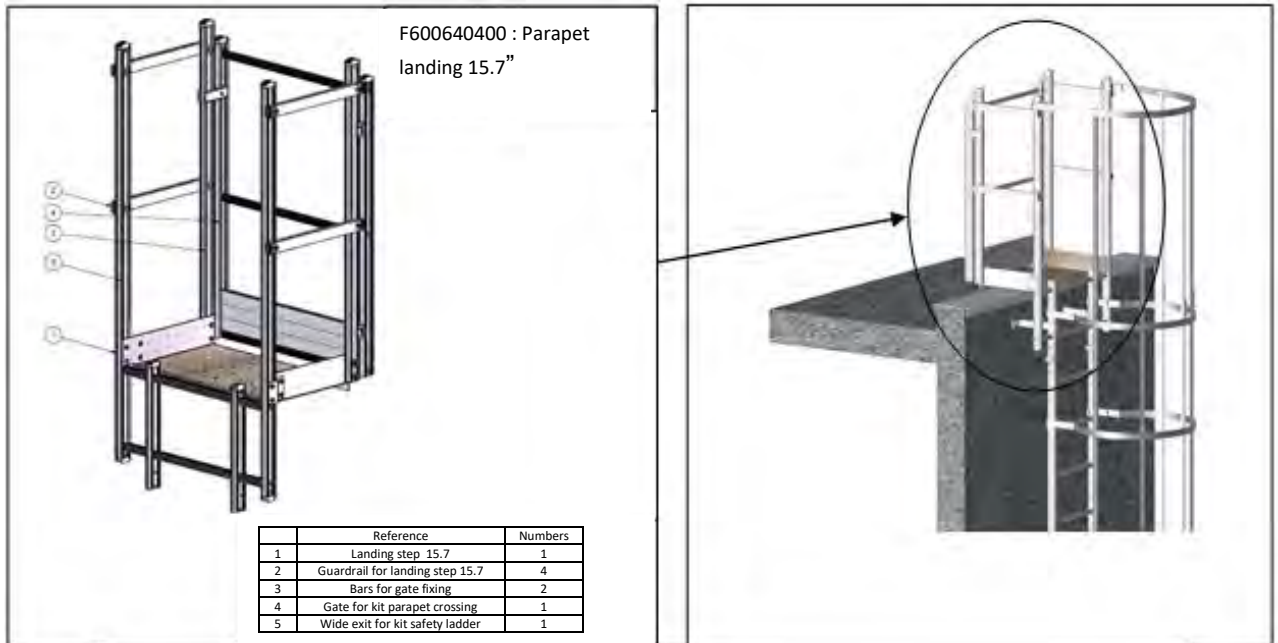

7.5 Assembly of ladderhead platform step 23.6" (600 mm) with no descent:

F600650600 : Landing step 600 mm

Reference	Numbers
1 Flat sheet landing step 400	1
2 Flat sheet landing step 200	1
3 Landing step 600 guardrail	4
4 Stainless steel A2 TH 8x25 bolt	3
5 Stainless steel A2 M8x18 cap nuts	3
6 Zn stainless steel A2 M8 brake nut	3

Without descend ladder

F600200041

F600200199 (2x)

F600200045

F030800006 (2x)

Reference	Numbers
1 Stainless steel A2 M8x30x1.5 cap nut	4
2 Black closing plug 40x40	2
3 Zn stainless steel A2 M8 brake nut	2
4 Stainless steel A2 TH M8x60 bolt	2
5 Landing step 400 guardrail	1

Reference	Numbers
1 Flat sheet landing step 200	1
2 Parapet crossing clamp	2
3 Stainless steel A2 M8x18 cap nuts	8
4 Zn stainless steel A2 M8 brake nut	12
5 Stainless steel A2 M8x30x1.5 cap nut	4
6 Stainless steel A2 TH 8x25 bolt	4
7 Stainless steel A2 TH M8x50 bolt	8

Reference	Numbers
1 Flat sheet landing step 400	1
2 Parapet crossing clamp	2
3 Stainless steel A2 M8x18 cap nuts	8
4 Zn stainless steel A2 M8 brake nut	12
5 Stainless steel A2 M8x30x1.5 cap nut	4
6 Stainless steel A2 TH 8x25 bolt	4
7 Stainless steel A2 TH M8x50 bolt	8

7.6 Assembly of ladderhead platform step 23.6" (600 mm) with descent:

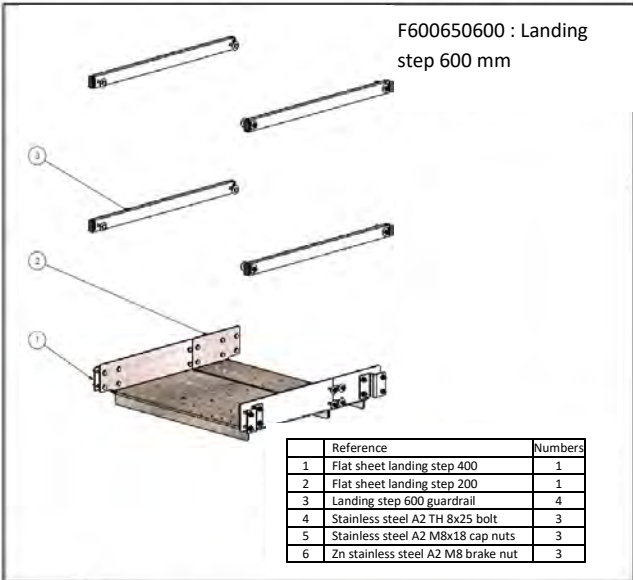

F600650600 : Landing step 600 mm

Reference	Numbers
1 Flat sheet landing step 400	1
2 Flat sheet landing step 200	1
3 Landing step 600 guardrail	4
4 Stainless steel A2 TH 8x25 bolt	3
5 Stainless steel A2 M8x18 cap nuts	3
6 Zn stainless steel A2 M8 brake nut	3

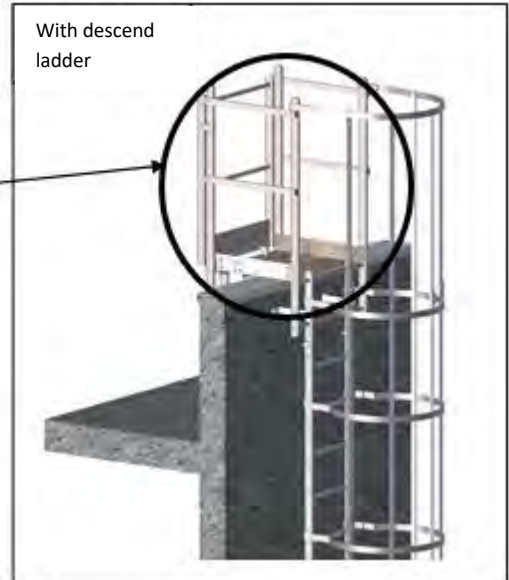

With descend ladder

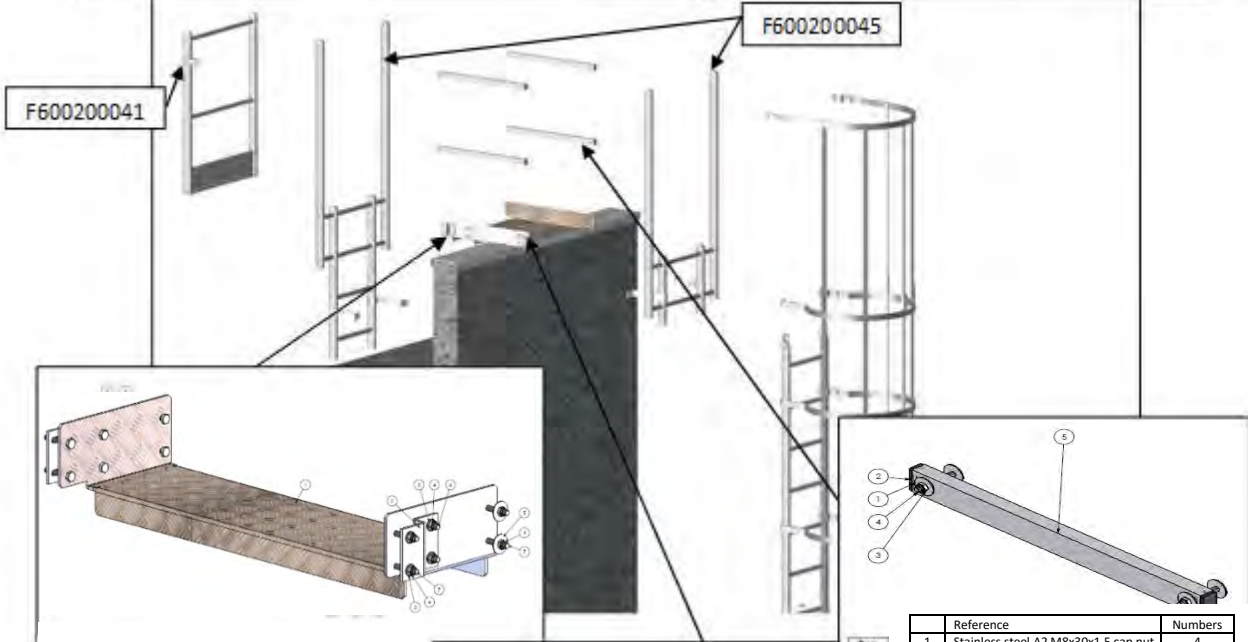

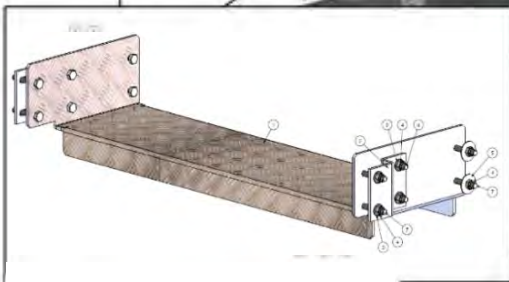

Reference	Numbers
1 Flat sheet landing step 200	1
2 Parapet crossing clamp	2
3 Stainless steel A2 M8x18 cap nuts	8
4 Zn stainless steel A2 M8 brake nut	12
5 Stainless steel A2 M8x30x1.5 cap nut	4
6 Stainless steel A2 TH 8x25 bolt	4
7 Stainless steel A2 TH M8x50 bolt	8

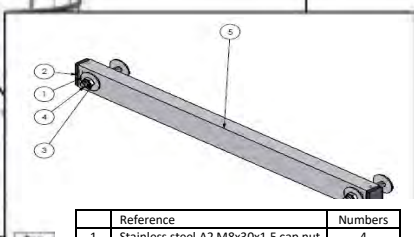

Reference	Numbers
1 Stainless steel A2 M8x30x1.5 cap nut	4
2 Black closing plug 40x40	2
3 Zn stainless steel A2 M8 brake nut	2
4 Stainless steel A2 TH M8x60 bolt	2
5 Landing step 400 guardrail	1

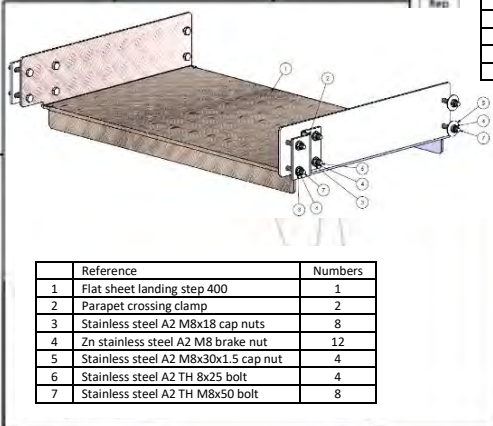

Reference	Numbers
1 Flat sheet landing step 400	1
2 Parapet crossing clamp	2
3 Stainless steel A2 M8x18 cap nuts	8
4 Zn stainless steel A2 M8 brake nut	12
5 Stainless steel A2 M8x30x1.5 cap nut	4
6 Stainless steel A2 TH 8x25 bolt	4
7 Stainless steel A2 TH M8x50 bolt	8

7.7 Assembly of ladderhead platform step 31.4" (800 mm) with no descent:

F600650800 : Landing step 800 mm

Reference	Numbers
1 Flat sheet landing step 400	2
2 Landing step 800 guardrail	4
3 Stainless steel A2 TH 8x25 bolt	3
4 Stainless steel A2 M8x18 cap nuts	3
5 Zn stainless steel A2 M8 brake nut	3

Without descend ladder

F600200199 (2x)

F600200045

F030800006 (2x)

Reference	Numbers
1 Flat sheet landing step 400	1
2 Parapet crossing clamp	2
3 Stainless steel A2 M8x18 cap nuts	8
4 Zn stainless steel A2 M8 brake nut	12
5 Stainless steel A2 M8x30x1.5 cap nut	4
6 Stainless steel A2 TH 8x25 bolt	4

Reference	Numbers
1 Stainless steel A2 M8x30x1.5 cap nut	4
2 Black closing plug 40x40	2
3 Zn stainless steel A2 M8 brake nut	2
4 Stainless steel A2 TH M8x60 bolt	2
5 Landing step 800 guardrail	1

7.8 Assembly of ladderhead platform step 31.4" (800 mm) with descent:

F600650800 : Landing step 800 mm

Reference	Numbers
1	2
2	4
3	3
4	3
5	3

Without descend ladder

F600200041

F600200045

Reference	Numbers
1	1
2	2
3	8
4	12
5	4
6	4
7	8

Reference	Numbers
1	4
2	2
3	2
4	2
5	1

7.9 Assembly of ladderhead platform step 39.4" (1000mm) with no descent:

F600651000 :
Landing step
1000 mm

Without descend
ladder

Reference	Numbers
1	2
2	1
3	1
4	1
5	4

F600200041

F600200199 (2x)

F600200045

F030800006 (2x)

Reference	Numbers
1	4
2	2
3	2
4	2
5	2

Reference	Numbers
1	1
2	2
3	8
4	12
5	4
6	4
7	8

Reference	Numbers
1	4
2	2
3	2
4	2
5	1

Reference	Numbers
1	1
2	2
3	8
4	12
5	4
6	4
7	8

7.10 Assembly of ladderhead platform step 39.4" (1000mm) with descent:

:

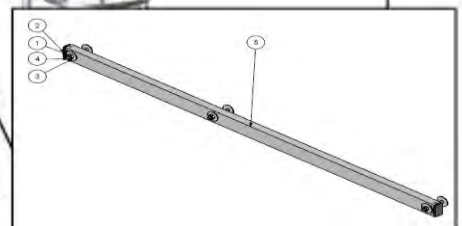
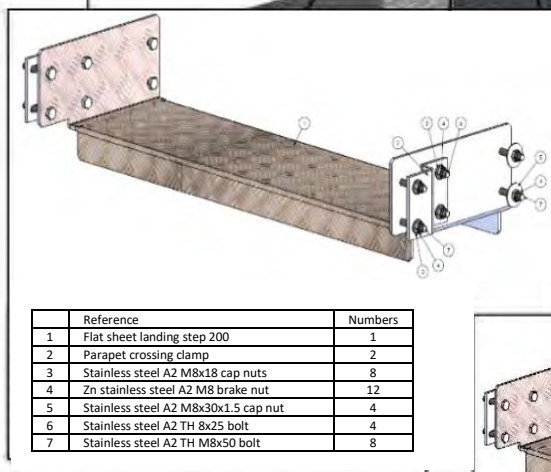
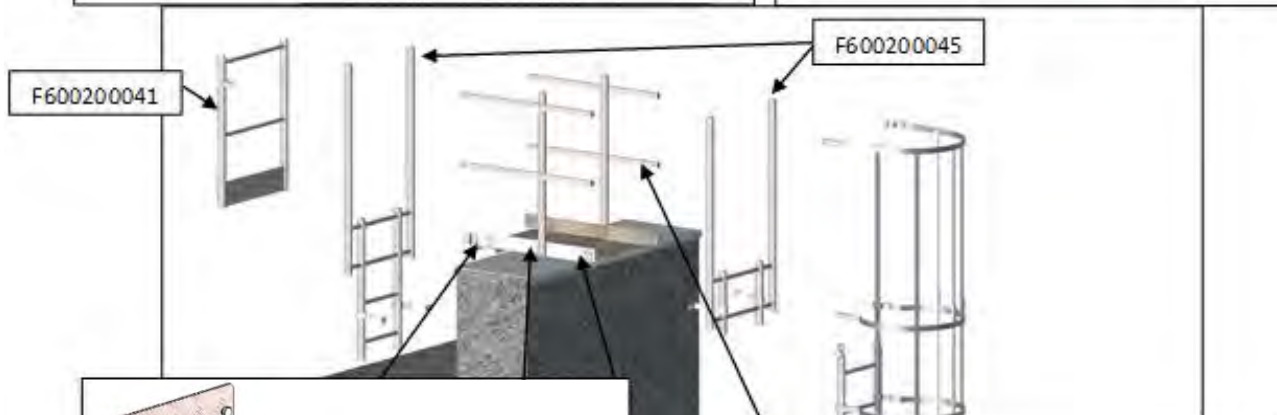
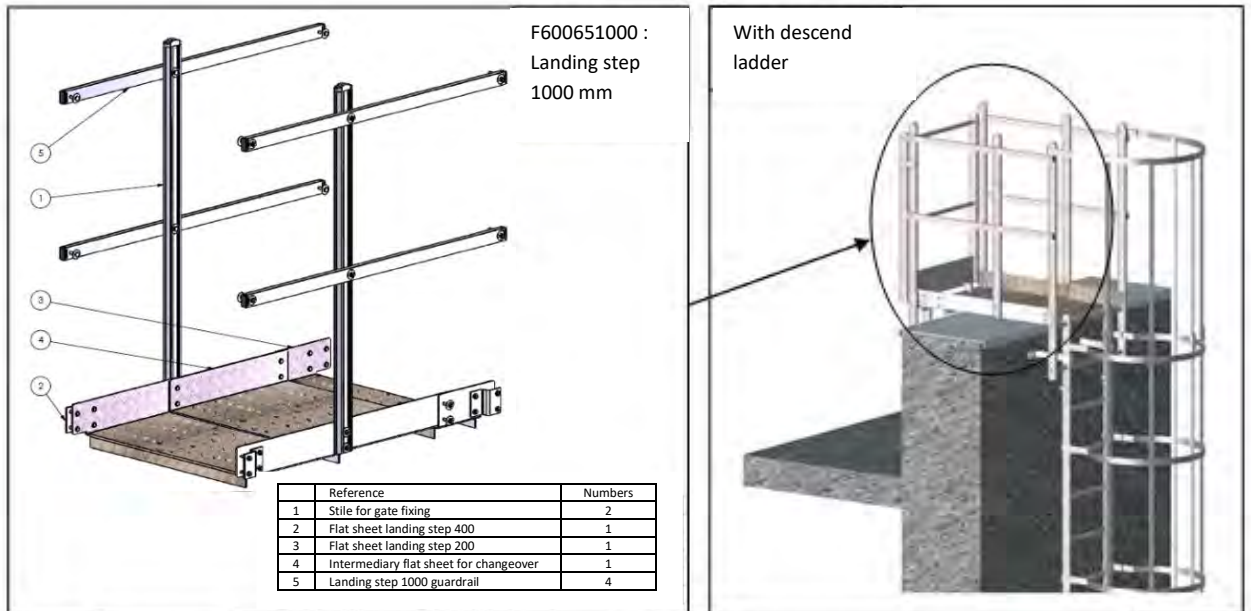

7.11 Assembly of ladderhead platform step 47.2" (1200mm) with no descent:

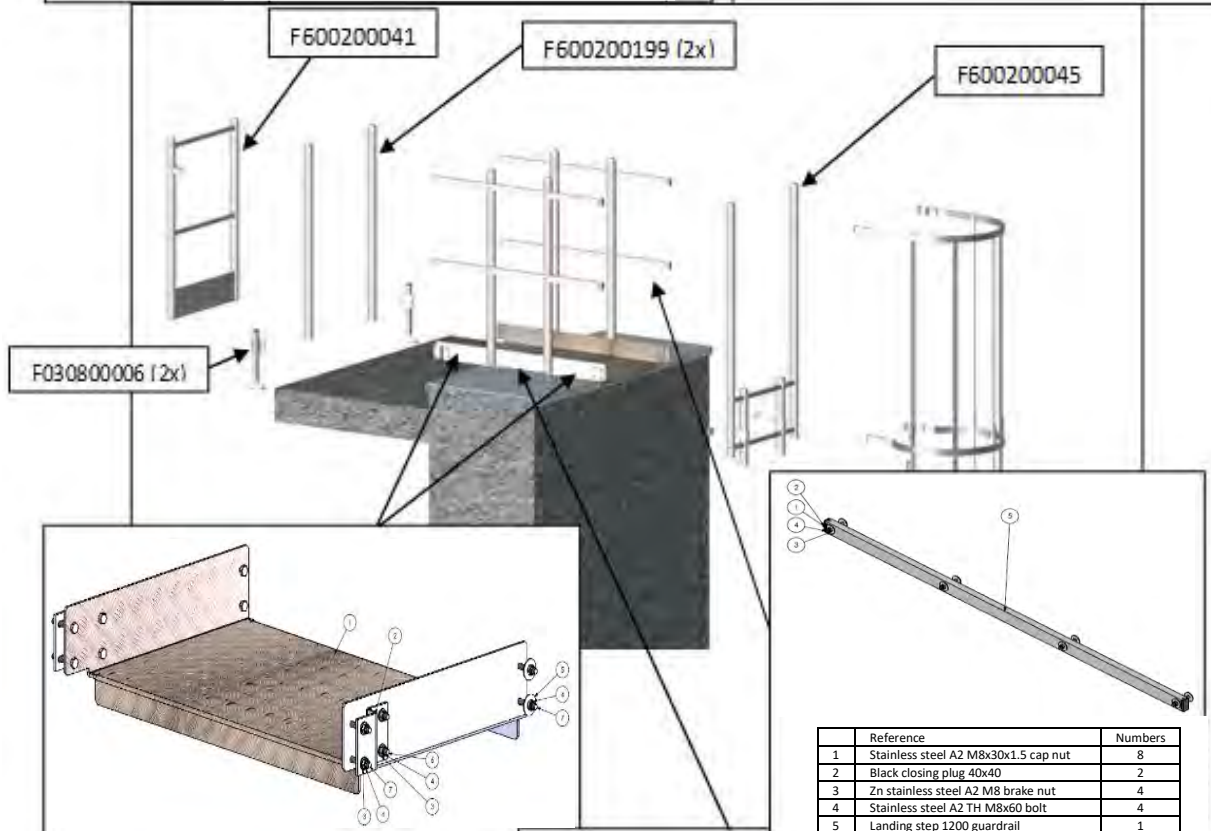
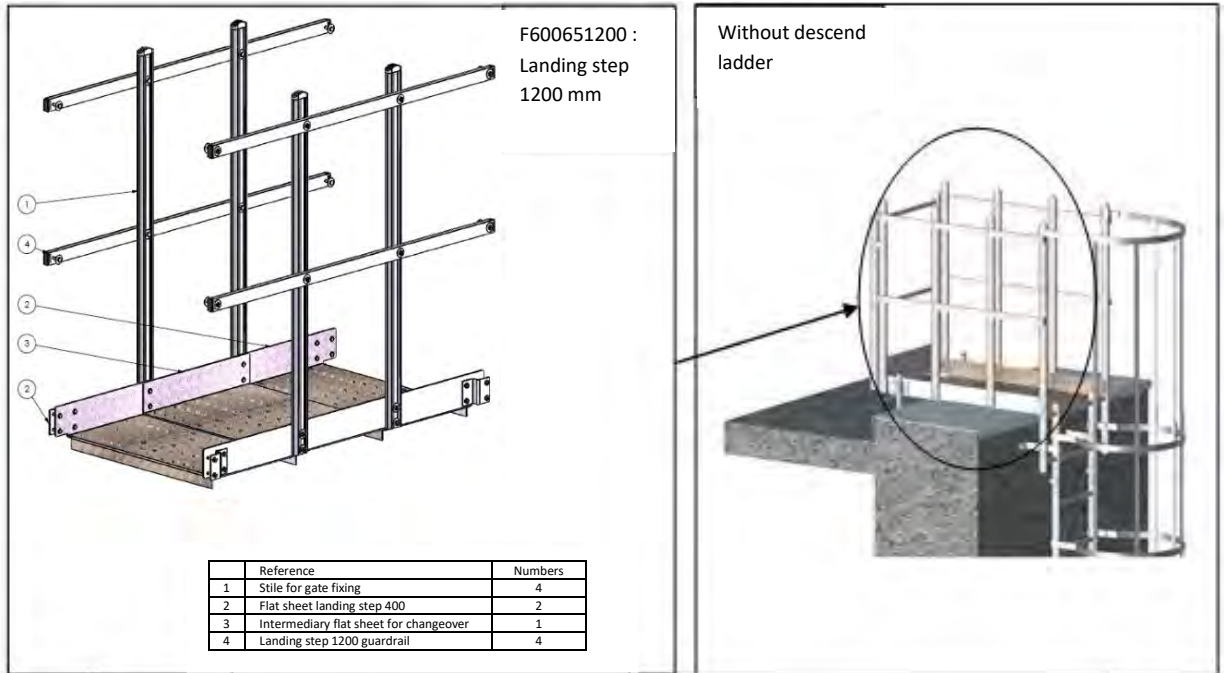

Reference	Numbers
1	1
2	2
3	8
4	12
5	4
6	4
7	8

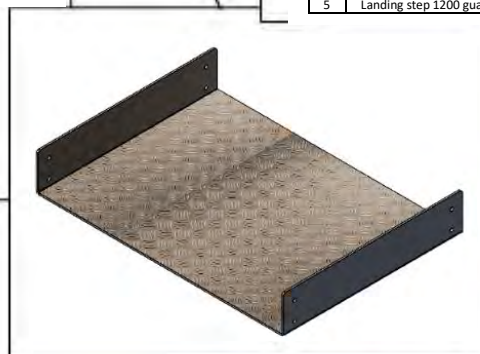

7.12 Assembly of ladderhead platform step 47.2" (1200mm) with descent:

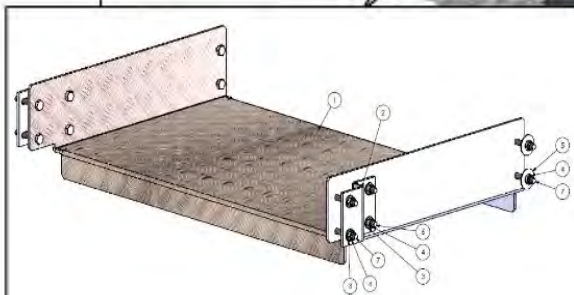
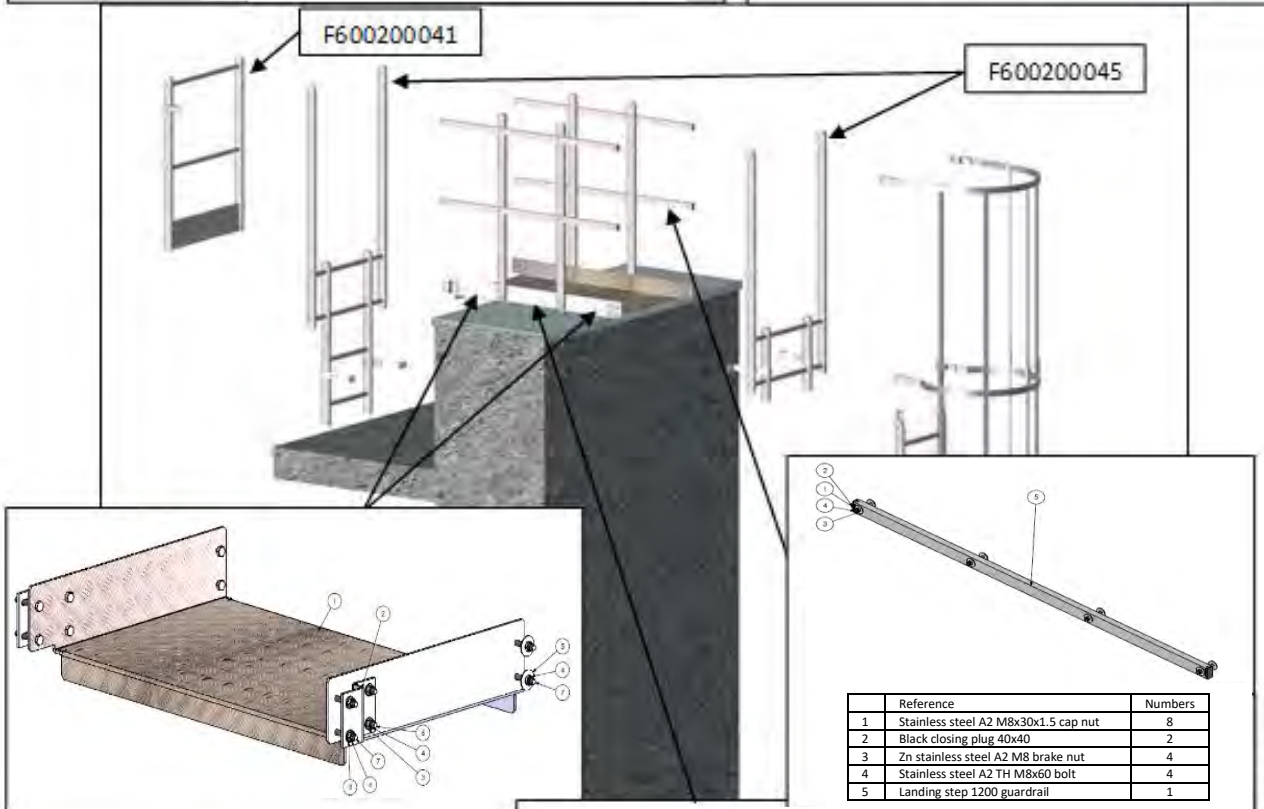
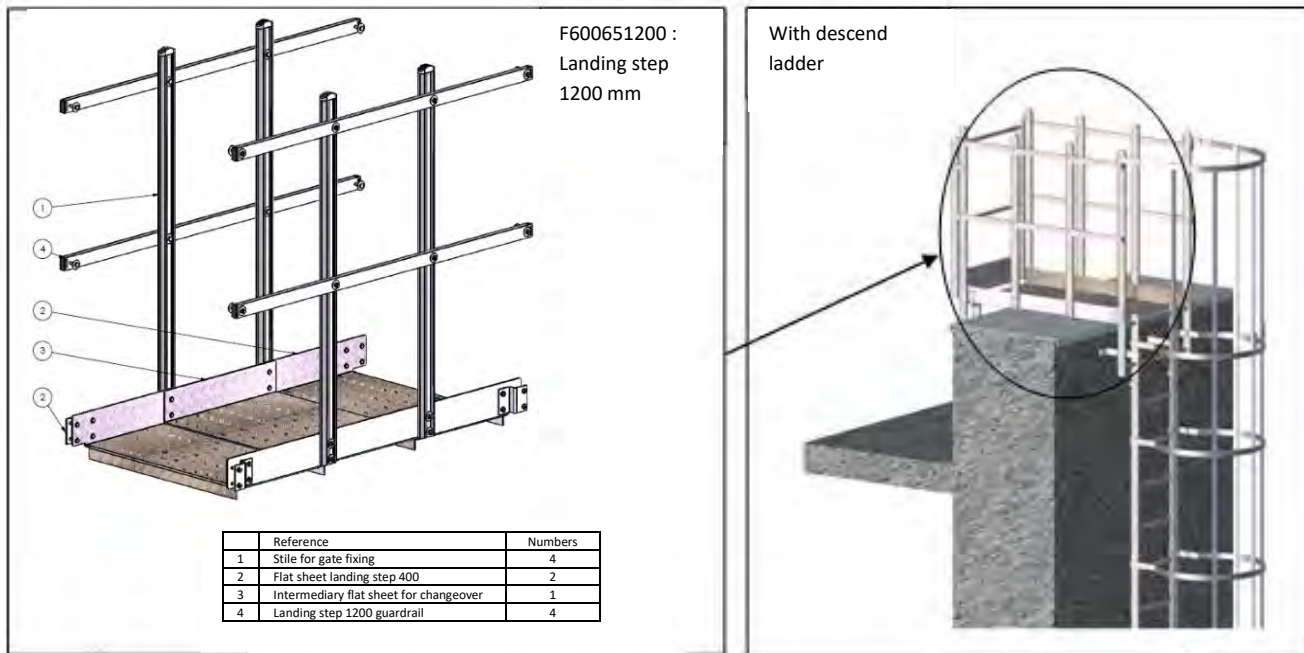

Reference	Numbers
1	1
2	2
3	8
4	12
5	4
6	4
7	8



8. SELECTING FIXINGS

Warning: these criteria are indicatives, refer to fixing manufacturer specifications.

→ Support type, size, function

Choose your fixing depending to:

- Support type and condition for provide an adequate anchoring:
 - o Crowded materials: concrete blocks (compression area: non-cracked concrete/tense area: cracked concrete), bricks, stones and building blocks, plaster blocks and aerated concrete.

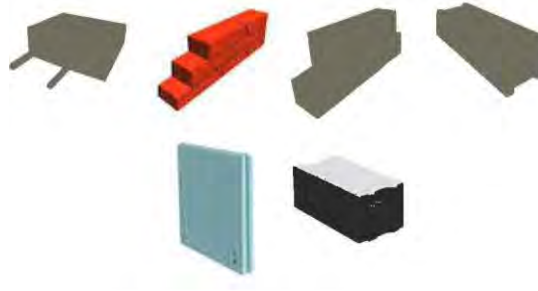

- o Hollow materials: bricks, building blocks, alveolar slabs, plaster blocks, alveolar partition and plasterboards.



- Support function: it's necessary to be sure that the dowel choice non-impact performances excepted from the support. Example: fire resistance, tightness, thermal and acoustic performances.

It's important to pay attention to mechanical properties would have been possible be alter.

→ Solitations

There are three load types:

- N: tractive effort for $0^\circ \leq a < 30^\circ$
- F: tractive effort for $30^\circ \leq a < 60^\circ$
- V: shearing effort for $60^\circ \leq a \leq 90^\circ$

Effort direction is defined by angle formed by the fixing axle and the applied load direction. The fixing type will be chosen according to sollicitation types which element to be fixed will subject.



Warning to the metals assemblage. The corrosion can be provided to the improper coupling between dowel and the piece to fix.

1. Installation conditions

Some installation conditions are required for anchoring characteristics (pullout, shearing resistance, ...) corresponding to the supplier announcement.

It's needed to check that following conditions are respected for the anchoring quality be guaranteed.

1. Distance conditions:
 1. Between dowels (between axes)
 2. Minimum distance from borders



2. Support conditions:
 1. Support condition and quality
 2. Support thickness

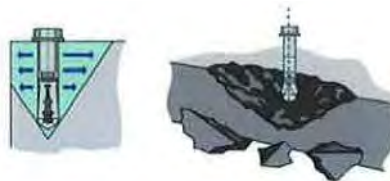

Choose the right fixing

Warning: these criteria are indicatives, refer to dowel manufacturer specifications.

DOWEL TYPE	Chemical			SUPPORT TYPE	
	Plastic mechanical <small>Nylon - Polyamide</small>	Hollow materials	Crowded materials		
Crowded materials					compression area: non-cracked concrete
					tense area: cracked concrete
					bricks, stones and building blocks
					plaster blocks
					aerated concrete
Hollow materials					bricks, building blocks
					Hollow plaster blocks
					alveolar slabs
					alveolar partition and plasterboards

Dowel adapted with support
1 Subject to test

Dowel non-adapted with support
2 According to supplier advice

DOWEL TYPE	Metal mechanical				SUPPORT TYPE	
	A Screwing expansion	Hit expansion (Type B)	A form locking (Type C)	Distortion		
Crowded materials					compression area: non-cracked concrete	
					tense area: cracked concrete	
					bricks, stones and building blocks	
					plaster blocks	
					aerated concrete	
Hollow materials					bricks, building blocks	
					Hollow plaster blocks	
					alveolar slabs	
					alveolar partition and plasterboards	

Dowel adapted with support
1 Subject to test

Dowel non-adapted with support
2 According to supplier advice

In case of building renovation, it's necessary to check that support is conform by doing a static test with an extractometer.

9. WARRANTY

FALLPROTEC guarantees the fixed ladder range (excepting specific clauses accepted by the customer and FALLPROTEC) for a period of 2 years from the delivery date (date given on the delivery slip) against all manufacturing defects, except for:

- Labour or travelling damages
- Wear and tear due to impacts, a lack of maintenance, shocks, etc.
- Use in inappropriate conditions or conditions that do not comply with those defined herein or installations that do not comply with the user installation instructions.

Any other compensation is formally excluded from the warranty, including operating loss, damage incurred and any prejudice whatsoever subsequent to using our manufactured products. Any modification, repair or replacement of parts during the warranty period does not extend the period of cover.

In case of installation in corrosive environment (example: plant with chemical products, less than one mile from sea side, any environment classified above C3 (ISO corrosivity categories)), the installer must contact Fallprotec prior to purchase and installation to verify compatibility.

Should our manufactured products be modified outside our production site without our prior written agreement, FALLPROTEC's liability cannot be involved.



Safety Rail Source, LLC
2570 Blvd. of the Generals
Suite 200
Norristown, PA 19403

Tel: (877) 723 3766
Fax: (610) 539 1630

www.safetyrailsource.com
Email: info@safetyrailsource.com