

power contactor, AC-3 17 A, 7.5 kW / 400 V 1 NO + 1 NC, 110 V AC, 50 Hz, 120 V, 60 Hz, 3-pole, Size S0, screw terminal



product brand name	SIRIUS
product designation	Power contactor
product type designation	3RT2

General technical data	
size of contactor	S0
product extension	
<ul style="list-style-type: none"> <li>function module for communication</li> </ul>	No
<ul style="list-style-type: none"> <li>auxiliary switch</li> </ul>	Yes
power loss [W] for rated value of the current	
<ul style="list-style-type: none"> <li>at AC in hot operating state</li> </ul>	2.7 W
<ul style="list-style-type: none"> <li>at AC in hot operating state per pole</li> </ul>	0.9 W
power loss [W] for rated value of the current without load current share typical	7.9 W
surge voltage resistance	
<ul style="list-style-type: none"> <li>of main circuit rated value</li> </ul>	6 kV
<ul style="list-style-type: none"> <li>of auxiliary circuit rated value</li> </ul>	6 kV
maximum permissible voltage for safe isolation	
<ul style="list-style-type: none"> <li>between coil and main contacts acc. to EN 60947-1</li> </ul>	400 V

<b>protection class IP</b>	
• on the front	IP20
• of the terminal	IP20
<b>shock resistance at rectangular impulse</b>	
• at AC	7,5g / 5 ms, 4,7g / 10 ms
<b>shock resistance with sine pulse</b>	
• at AC	11,8g / 5 ms, 7,4g / 10 ms
<b>mechanical service life (switching cycles)</b>	
• of contactor typical	10 000 000
• of the contactor with added electronically optimized auxiliary switch block typical	5 000 000
• of the contactor with added auxiliary switch block typical	10 000 000
<b>reference code acc. to IEC 81346-2</b>	Q

<b>Ambient conditions</b>	
• installation altitude at height above sea level maximum	2 000 m
<b>ambient temperature</b>	
• during operation	-25 ... +60 °C
• during storage	-55 ... +80 °C

<b>Main circuit</b>	
<b>number of poles for main current circuit</b>	3
<b>number of NO contacts for main contacts</b>	3
<b>operating voltage</b>	
• at AC-3 rated value maximum	690 V
<b>operational current</b>	
• at AC-1 at 400 V — at ambient temperature 40 °C rated value	40 A
• at AC-1 — up to 690 V at ambient temperature 40 °C rated value	40 A
— up to 690 V at ambient temperature 60 °C rated value	35 A
• at AC-3 — at 400 V rated value	17 A
— at 500 V rated value	17 A
— at 690 V rated value	13 A
• at AC-4 at 400 V rated value	15.5 A
• at AC-5a up to 690 V rated value	35.2 A
• at AC-5b up to 400 V rated value	14.1 A
• at AC-6a	

— up to 230 V for current peak value n=20 rated value	11.4 A
— up to 400 V for current peak value n=20 rated value	11.4 A
— up to 500 V for current peak value n=20 rated value	11.4 A
— up to 690 V for current peak value n=20 rated value	11.3 A
• at AC-6a	
— up to 230 V for current peak value n=30 rated value	7.6 A
— up to 400 V for current peak value n=30 rated value	7.6 A
— up to 500 V for current peak value n=30 rated value	7.6 A
— up to 690 V for current peak value n=30 rated value	7.6 A
<b>minimum cross-section in main circuit</b>	
• at maximum AC-1 rated value	10 mm <sup>2</sup>
<b>operational current for approx. 200000 operating cycles at AC-4</b>	
• at 400 V rated value	7.7 A
• at 690 V rated value	7.7 A
<b>operational current</b>	
• at 1 current path at DC-1	
— at 24 V rated value	35 A
— at 110 V rated value	4.5 A
— at 220 V rated value	1 A
— at 440 V rated value	0.4 A
— at 600 V rated value	0.25 A
• with 2 current paths in series at DC-1	
— at 24 V rated value	35 A
— at 110 V rated value	35 A
— at 220 V rated value	5 A
— at 440 V rated value	1 A
— at 600 V rated value	0.8 A
• with 3 current paths in series at DC-1	
— at 24 V rated value	35 A
— at 110 V rated value	35 A
— at 220 V rated value	35 A
— at 440 V rated value	2.9 A
— at 600 V rated value	1.4 A
<b>operational current</b>	

<ul style="list-style-type: none"> <li>• at 1 current path at DC-3 at DC-5 <ul style="list-style-type: none"> <li>— at 24 V rated value</li> <li>— at 110 V rated value</li> <li>— at 220 V rated value</li> <li>— at 440 V rated value</li> <li>— at 600 V rated value</li> </ul> </li> <li>• with 2 current paths in series at DC-3 at DC-5 <ul style="list-style-type: none"> <li>— at 24 V rated value</li> <li>— at 110 V rated value</li> <li>— at 220 V rated value</li> <li>— at 440 V rated value</li> <li>— at 600 V rated value</li> </ul> </li> <li>• with 3 current paths in series at DC-3 at DC-5 <ul style="list-style-type: none"> <li>— at 24 V rated value</li> <li>— at 110 V rated value</li> <li>— at 220 V rated value</li> <li>— at 440 V rated value</li> <li>— at 600 V rated value</li> </ul> </li> </ul>	<p>20 A</p> <p>2.5 A</p> <p>1 A</p> <p>0.09 A</p> <p>0.06 A</p> <p>35 A</p> <p>15 A</p> <p>3 A</p> <p>0.27 A</p> <p>0.16 A</p> <p>35 A</p> <p>35 A</p> <p>10 A</p> <p>0.6 A</p> <p>0.6 A</p>
<p><b>operating power</b></p> <ul style="list-style-type: none"> <li>• at AC-3 <ul style="list-style-type: none"> <li>— at 230 V rated value</li> <li>— at 400 V rated value</li> <li>— at 500 V rated value</li> <li>— at 690 V rated value</li> </ul> </li> </ul>	<p>4 kW</p> <p>7.5 kW</p> <p>7.5 kW</p> <p>11 kW</p>
<p><b>operating power for approx. 200000 operating cycles at AC-4</b></p> <ul style="list-style-type: none"> <li>• at 400 V rated value</li> <li>• at 690 V rated value</li> </ul>	<p>3.5 kW</p> <p>6 kW</p>
<p><b>operating apparent power at AC-6a</b></p> <ul style="list-style-type: none"> <li>• up to 230 V for current peak value n=20 rated value</li> <li>• up to 400 V for current peak value n=20 rated value</li> <li>• up to 500 V for current peak value n=20 rated value</li> <li>• up to 690 V for current peak value n=20 rated value</li> </ul>	<p>4.5 kV·A</p> <p>7.8 kV·A</p> <p>9.9 kV·A</p> <p>13.6 kV·A</p>
<p><b>operating apparent power at AC-6a</b></p> <ul style="list-style-type: none"> <li>• up to 230 V for current peak value n=30 rated value</li> <li>• up to 400 V for current peak value n=30 rated value</li> </ul>	<p>3 kV·A</p> <p>5.2 kV·A</p>

<ul style="list-style-type: none"> <li>• up to 500 V for current peak value n=30 rated value</li> <li>• up to 690 V for current peak value n=30 rated value</li> </ul>	6.6 kV·A 9.1 kV·A
<b>short-time withstand current in cold operating state up to 40 °C</b> <ul style="list-style-type: none"> <li>• limited to 1 s switching at zero current maximum</li> <li>• limited to 5 s switching at zero current maximum</li> <li>• limited to 10 s switching at zero current maximum</li> <li>• limited to 30 s switching at zero current maximum</li> <li>• limited to 60 s switching at zero current maximum</li> </ul>	225 A; Use minimum cross-section acc. to AC-1 rated value 225 A; Use minimum cross-section acc. to AC-1 rated value 180 A; Use minimum cross-section acc. to AC-1 rated value 115 A; Use minimum cross-section acc. to AC-1 rated value 96 A; Use minimum cross-section acc. to AC-1 rated value
<b>no-load switching frequency</b> <ul style="list-style-type: none"> <li>• at AC</li> </ul>	5 000 1/h
<b>operating frequency</b> <ul style="list-style-type: none"> <li>• at AC-1 maximum</li> <li>• at AC-2 maximum</li> <li>• at AC-3 maximum</li> <li>• at AC-4 maximum</li> </ul>	1 000 1/h 1 000 1/h 1 000 1/h 300 1/h
<b>Control circuit/ Control</b>	
<b>type of voltage of the control supply voltage</b>	AC
<b>control supply voltage at AC</b> <ul style="list-style-type: none"> <li>• at 50 Hz rated value</li> <li>• at 60 Hz rated value</li> </ul>	110 V 120 V
<b>operating range factor control supply voltage rated value of magnet coil at AC</b> <ul style="list-style-type: none"> <li>• at 50 Hz</li> <li>• at 60 Hz</li> </ul>	0.8 ... 1.1 0.8 ... 1.1
<b>apparent pick-up power of magnet coil at AC</b> <ul style="list-style-type: none"> <li>• at 50 Hz</li> <li>• at 60 Hz</li> </ul>	68 V·A 67 V·A
<b>inductive power factor with closing power of the coil</b> <ul style="list-style-type: none"> <li>• at 50 Hz</li> <li>• at 60 Hz</li> </ul>	0.72 0.74
<b>apparent holding power of magnet coil at AC</b> <ul style="list-style-type: none"> <li>• at 50 Hz</li> <li>• at 60 Hz</li> </ul>	7.9 V·A 6.5 V·A
<b>inductive power factor with the holding power of the coil</b>	

<ul style="list-style-type: none"> <li>• at 50 Hz</li> <li>• at 60 Hz</li> </ul>	0.25 0.28
<b>closing delay</b>	
<ul style="list-style-type: none"> <li>• at AC</li> </ul>	9 ... 38 ms
<b>opening delay</b>	
<ul style="list-style-type: none"> <li>• at AC</li> </ul>	4 ... 16 ms
<b>arcing time</b>	10 ... 10 ms
<b>control version of the switch operating mechanism</b>	Standard A1 - A2

#### Auxiliary circuit

<b>number of NC contacts for auxiliary contacts</b>	
<ul style="list-style-type: none"> <li>• instantaneous contact</li> </ul>	1
<b>number of NO contacts for auxiliary contacts</b>	
<ul style="list-style-type: none"> <li>• instantaneous contact</li> </ul>	1
<b>operational current at AC-12 maximum</b>	10 A
<b>operational current at AC-15</b>	
<ul style="list-style-type: none"> <li>• at 230 V rated value</li> <li>• at 400 V rated value</li> <li>• at 500 V rated value</li> <li>• at 690 V rated value</li> </ul>	10 A 3 A 2 A 1 A
<b>operational current at DC-12</b>	
<ul style="list-style-type: none"> <li>• at 24 V rated value</li> <li>• at 48 V rated value</li> <li>• at 60 V rated value</li> <li>• at 110 V rated value</li> <li>• at 125 V rated value</li> <li>• at 220 V rated value</li> <li>• at 600 V rated value</li> </ul>	10 A 6 A 6 A 3 A 2 A 1 A 0.15 A
<b>operational current at DC-13</b>	
<ul style="list-style-type: none"> <li>• at 24 V rated value</li> <li>• at 48 V rated value</li> <li>• at 60 V rated value</li> <li>• at 110 V rated value</li> <li>• at 125 V rated value</li> <li>• at 220 V rated value</li> <li>• at 600 V rated value</li> </ul>	10 A 2 A 2 A 1 A 0.9 A 0.3 A 0.1 A
<b>contact reliability of auxiliary contacts</b>	1 faulty switching per 100 million (17 V, 1 mA)

#### UL/CSA ratings

<b>full-load current (FLA) for 3-phase AC motor</b>	
<ul style="list-style-type: none"> <li>• at 480 V rated value</li> <li>• at 600 V rated value</li> </ul>	14 A 17 A
<b>yielded mechanical performance [hp]</b>	

<ul style="list-style-type: none"> <li>• for single-phase AC motor <ul style="list-style-type: none"> <li>— at 110/120 V rated value</li> <li>— at 230 V rated value</li> </ul> </li> <li>• for 3-phase AC motor <ul style="list-style-type: none"> <li>— at 200/208 V rated value</li> <li>— at 220/230 V rated value</li> <li>— at 460/480 V rated value</li> <li>— at 575/600 V rated value</li> </ul> </li> </ul>	<p>1 hp</p> <p>3 hp</p> <p>3 hp</p> <p>5 hp</p> <p>10 hp</p> <p>15 hp</p>
<b>contact rating of auxiliary contacts according to UL</b>	A600 / P600

### Short-circuit protection

<b>design of the fuse link</b>	
<ul style="list-style-type: none"> <li>• for short-circuit protection of the main circuit <ul style="list-style-type: none"> <li>— with type of coordination 1 required</li> <li>— with type of assignment 2 required</li> </ul> </li> <li>• for short-circuit protection of the auxiliary switch required</li> </ul>	<p>gG: 63A (690V,100kA), aM: 32A (690V,100kA), BS88: 63A (415V,80kA)</p> <p>gG: 25A (690V,100kA), aM: 20A (690V,100kA), BS88: 25A (415V,80kA)</p> <p>gG: 10 A (500 V, 1 kA)</p>

### Installation/ mounting/ dimensions

<b>mounting position</b>	+/-180° rotation possible on vertical mounting surface; can be tilted forward and backward by +/- 22.5° on vertical mounting surface
<b>fastening method</b>	screw and snap-on mounting onto 35 mm standard mounting rail according to DIN EN 60715
<ul style="list-style-type: none"> <li>• side-by-side mounting</li> </ul>	Yes
<b>height</b>	85 mm
<b>width</b>	45 mm
<b>depth</b>	97 mm
<b>required spacing</b>	
<ul style="list-style-type: none"> <li>• with side-by-side mounting <ul style="list-style-type: none"> <li>— forwards</li> <li>— upwards</li> <li>— downwards</li> <li>— at the side</li> </ul> </li> <li>• for grounded parts <ul style="list-style-type: none"> <li>— forwards</li> <li>— upwards</li> <li>— at the side</li> <li>— downwards</li> </ul> </li> <li>• for live parts <ul style="list-style-type: none"> <li>— forwards</li> <li>— upwards</li> </ul> </li> </ul>	<p>10 mm</p> <p>10 mm</p> <p>10 mm</p> <p>0 mm</p> <p>10 mm</p> <p>10 mm</p> <p>6 mm</p> <p>10 mm</p> <p>10 mm</p> <p>10 mm</p>

- downwards
- at the side

10 mm  
6 mm













## Connections/ Terminals

<b>type of electrical connection</b> <ul style="list-style-type: none"> <li>• for main current circuit</li> <li>• for auxiliary and control circuit</li> <li>• at contactor for auxiliary contacts</li> <li>• of magnet coil</li> </ul>	screw-type terminals screw-type terminals Screw-type terminals Screw-type terminals
<b>type of connectable conductor cross-sections</b> <ul style="list-style-type: none"> <li>• for main contacts               <ul style="list-style-type: none"> <li>— solid</li> <li>— solid or stranded</li> <li>— finely stranded with core end processing</li> </ul> </li> <li>• at AWG cables for main contacts</li> </ul>	2x (1 ... 2.5 mm <sup>2</sup> ), 2x (2.5 ... 10 mm <sup>2</sup> ) 2x (1 ... 2,5 mm <sup>2</sup> ), 2x (2,5 ... 10 mm <sup>2</sup> ) 2x (1 ... 2.5 mm <sup>2</sup> ), 2x (2.5 ... 6 mm <sup>2</sup> ), 1x 10 mm <sup>2</sup> 2x (16 ... 12), 2x (14 ... 8)
<b>connectable conductor cross-section for main contacts</b> <ul style="list-style-type: none"> <li>• solid</li> <li>• stranded</li> <li>• finely stranded with core end processing</li> </ul>	1 ... 10 mm <sup>2</sup> 1 ... 10 mm <sup>2</sup> 1 ... 10 mm <sup>2</sup>
<b>connectable conductor cross-section for auxiliary contacts</b> <ul style="list-style-type: none"> <li>• solid or stranded</li> <li>• finely stranded with core end processing</li> </ul>	0.5 ... 2.5 mm <sup>2</sup> 0.5 ... 2.5 mm <sup>2</sup>
<b>type of connectable conductor cross-sections for auxiliary contacts</b> <ul style="list-style-type: none"> <li>— solid or stranded</li> <li>— finely stranded with core end processing</li> </ul>	2x (0,5 ... 1,5 mm <sup>2</sup> ), 2x (0,75 ... 2,5 mm <sup>2</sup> ) 2x (0.5 ... 1.5 mm <sup>2</sup> ), 2x (0.75 ... 2.5 mm <sup>2</sup> )
<b>type of connectable conductor cross-sections at AWG cables for auxiliary contacts</b>	2x (20 ... 16), 2x (18 ... 14)
<b>AWG number as coded connectable conductor cross section</b> <ul style="list-style-type: none"> <li>• for main contacts</li> <li>• for auxiliary contacts</li> </ul>	16 ... 8 20 ... 14
<b>Safety related data</b>	
<b>B10 value</b> <ul style="list-style-type: none"> <li>• with high demand rate acc. to SN 31920</li> </ul>	1 000 000
<b>proportion of dangerous failures</b> <ul style="list-style-type: none"> <li>• with low demand rate acc. to SN 31920</li> <li>• with high demand rate acc. to SN 31920</li> </ul>	40 % 73 %
<b>failure rate [FIT]</b> <ul style="list-style-type: none"> <li>• with low demand rate acc. to SN 31920</li> </ul>	100 FIT
<b>product function</b>	



• mirror contact acc. to IEC 60947-4-1	Yes
T1 value for proof test interval or service life acc. to IEC 61508	20 y
touch protection against electrical shock	finger-safe
suitability for use safety-related switching OFF	Yes

## Certificates/ approvals

General Product Approval				EMC	
 CSA	 CCC	 UL	<a href="#">KC</a>		 RCM
Declaration of Conformity		Test Certificates		Marine / Shipping	
 EG-Konf.	<a href="#">Miscellaneous</a>	<a href="#">Type Test Certificates/Test Report</a>	<a href="#">Special Test Certificate</a>	 ABS	 BUREAU VERITAS
Marine / Shipping				other	
 LRS	 RINA	 RMRS	 DNV-GL DNVGL.COM/AF	<a href="#">Confirmation</a>	 VDE

## Further information

Information- and Downloadcenter (Catalogs, Brochures,...)

<https://www.siemens.com/ic10>

Industry Mall (Online ordering system)

<https://mall.industry.siemens.com/mall/en/en/Catalog/product?mlfb=3RT2025-1AK60>

Cax online generator

<http://support.automation.siemens.com/WW/CAXorder/default.aspx?lang=en&mlfb=3RT2025-1AK60>

Service&Support (Manuals, Certificates, Characteristics, FAQs,...)

<https://support.industry.siemens.com/cs/ww/en/ps/3RT2025-1AK60>

Image database (product images, 2D dimension drawings, 3D models, device circuit diagrams, EPLAN macros, ...)

[http://www.automation.siemens.com/bilddb/cax\\_de.aspx?mlfb=3RT2025-1AK60&lang=en](http://www.automation.siemens.com/bilddb/cax_de.aspx?mlfb=3RT2025-1AK60&lang=en)

Characteristic: Tripping characteristics, I<sup>t</sup>, Let-through current

<https://support.industry.siemens.com/cs/ww/en/ps/3RT2025-1AK60/char>

Further characteristics (e.g. electrical endurance, switching frequency)

<http://www.automation.siemens.com/bilddb/index.aspx?view=Search&mlfb=3RT2025-1AK60&objecttype=14&gridview=view1>

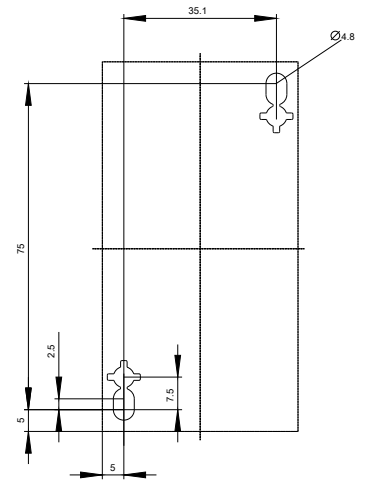
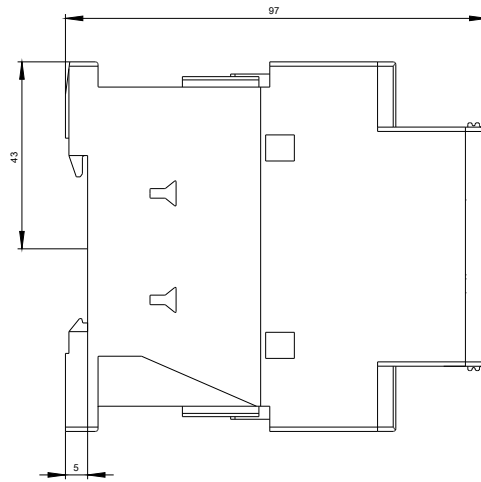
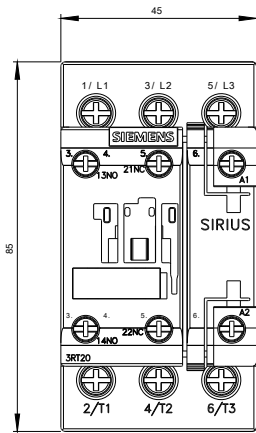



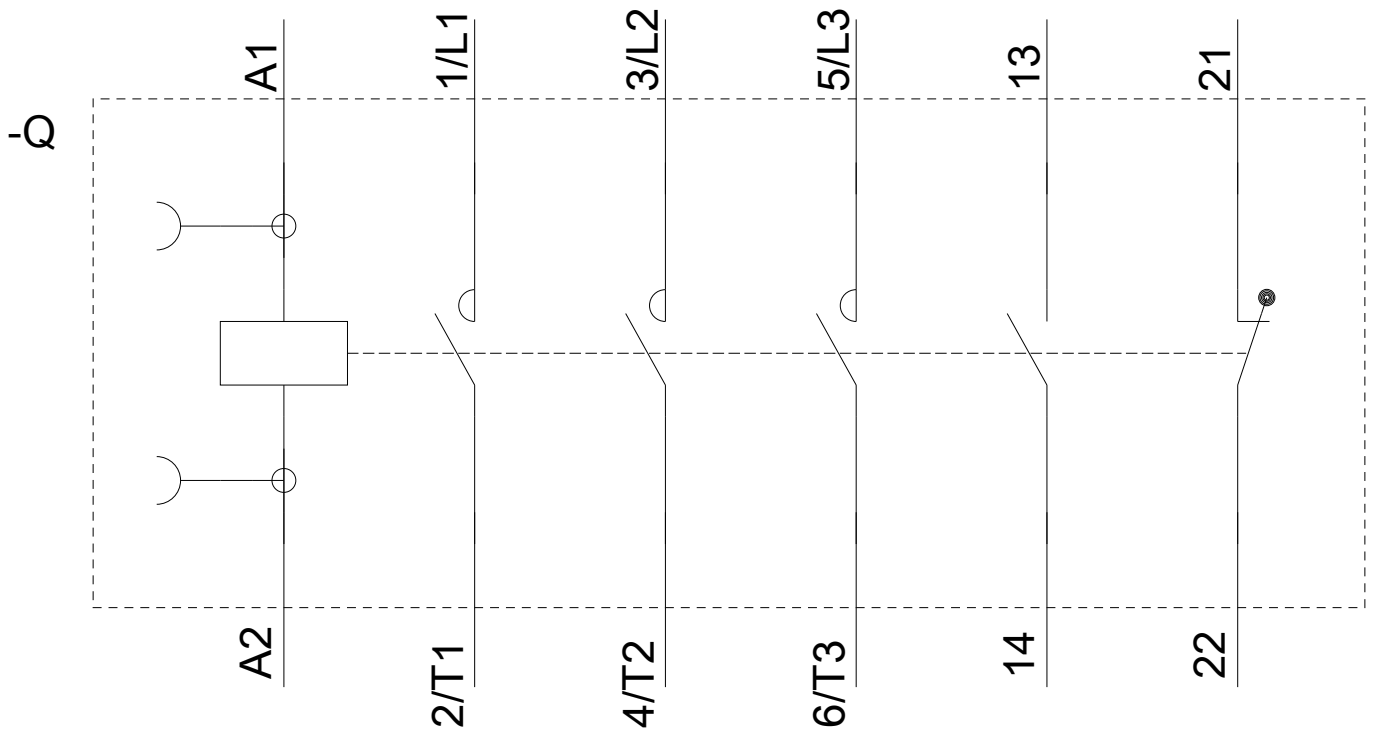

last modified:

11/23/2020