



BALL CHAIR USER GUIDE

#35955

SAFETY

Please read before using or setting up the Aeromat® Ball Chair

Not all exercises are suitable for everyone. To reduce the risk of injury, consult your physician before starting any exercise program with this product or any other exercise equipment. Please ensure that you do NOT have any medical or health conditions that could affect the safety or effectiveness of your exercise program. If you suffer from heart disease, high blood pressure, or any other health conditions, consult your physician before starting any exercise program. If at any time during your exercise you are experiencing discomfort or pain, stop the exercise immediately and consult your physician. The instruction presented herein is in no way intended as a substitute for medical counseling. Perform stretches and exercises in a slow and controlled manner. Stop and rest if you feel dizzy or short of breath.

Choose a generously sized area that is clear of furniture and other obstructions before performing stretches or exercises. Use the product only on smooth surfaces. Do not use balls if deep scratches or gouges are present. Use product only as intended. Please note that the ambient temperature and pressure will affect the ball size. Slight leakage is normal. Please adjust the inflation level as needed.

Lock casters firmly before performing stretches or exercises when using the chair

CAUTION: Weight on this product should NOT exceed 300 lbs.

CARE

1. Avoid exposing the ball to rough, sharp abrasive surfaces, heat and excessive sunlight.
2. Avoid placing or rolling ball on newspaper or other materials printed in ink as ink may permanently mark the ball.
3. Hand wash ball with a soft cloth and warm soapy water. Do not use harsh or abrasive chemicals or cleaning tools that may scratch the ball. Wipe chair with a damp cloth.
4. When using the ball chair, ensure all parts are firmly attached with the ball pumped to recommended size of 49 cm in circumference or to desired firmness. Leakage may occur over time. Re-inflate when necessary.

BALL INFLATION





















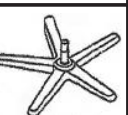

1. Remove the Aeromat® Ball Chair from the package and inspect for any shipping damages. Follow Ball Chair assembly instructions. Please note: It is normal for the ball to have slight creases when first inflated. Make sure that the ball is at room temperature before inflating.
 2. Use the hand pump to inflate the ball. DO NOT overinflate.
 3. Remove the hand pump and immediately insert the plug into hole.
- *The ball is made of burst resistant material.*

Ball may not inflate to 100% to size on initial inflation.

WAIT 24 HOURS. Deflate 50% and inflate again.

Due to the ball's material, the ball will increase to proper size with second Inflation.

PARTS LIST

No	Parts	QTY	No	Parts	QTY
A		1	J-1		2
B		1	K		2
C		1	L		1
D		2	M		2
E		1	N		7
F		1	O		2
G		1	P		1
H		1	Q		1
I		1	R		2
J		3	S		1
			T		1
			U		1

ASSEMBLY STEPS

STEP 1

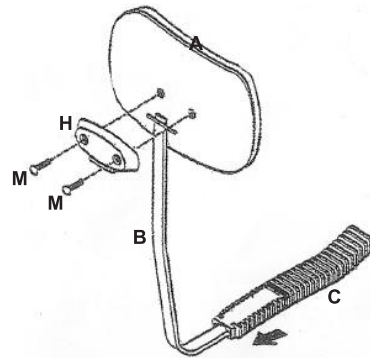

STEP 2

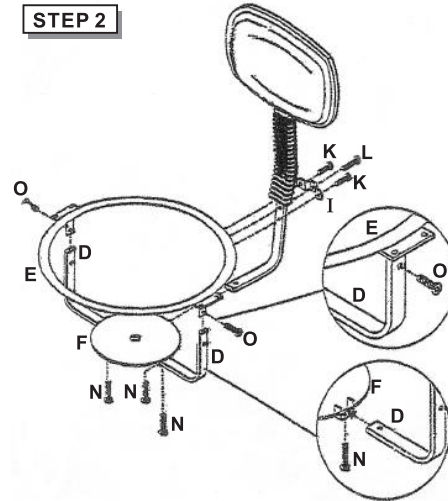

STEP 3

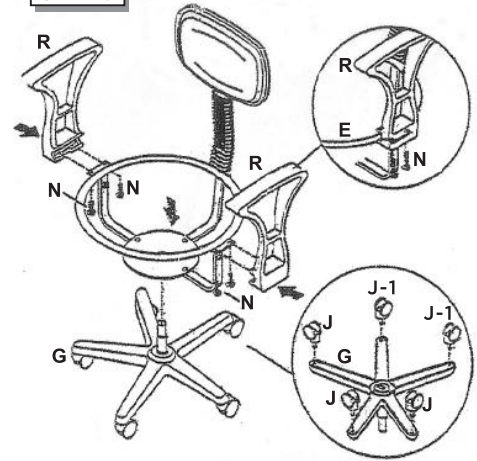

STEP 4

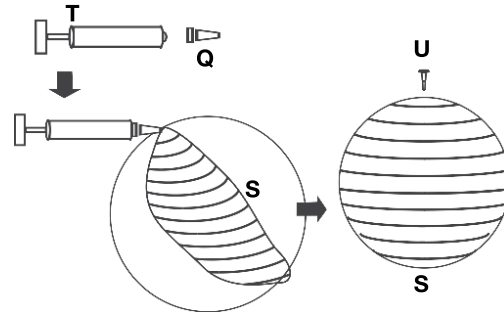

Ball may not inflate to 100% to size on initial inflation. **WAIT 24 HOURS. Deflate 50% and inflate again. Due to the ball's material, the ball will increase to proper size with second inflation**

Finished Figure

