

# ZENDURE

*Get Charged. Get Going.*

## SuperBase Pro 2000

## User Manual

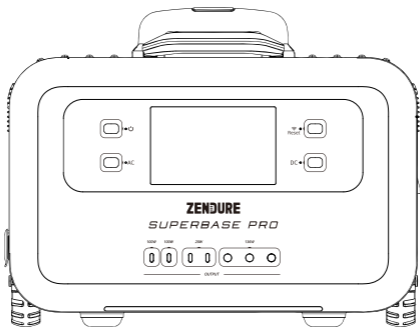

## DISCLAIMER

Read all safety guidelines, warnings and other product information in this manual carefully, and read any labels or stickers attached to the product before using. Users take full responsibility for the safe usage and operation of this product. Familiarize yourself with relevant regulations in your area. You are solely responsible for being aware of all relevant regulations and using Zendure products in a way that is compliant. Keep this manual for future reference.

## CONTENTS

<b>1.Specifications</b> .....	2
<b>2.Safety Guidelines</b> .....	3
2.1 Usage .....	4
2.2 Disposal Guide .....	4
<b>3.Getting Started</b> .....	4
3.1 Interface .....	4
3.2 Display .....	5
3.3 General Product Usage .....	6
3.4 AC Recharging .....	8
3.5 Solar Recharging .....	9
3.6 Car Recharging.....	10
3.7 Cell Network & GPS.....	10
3.8 Zendure App.....	10
3.9 AmpUp Mode .....	11
3.10 Sleep Mode .....	11
3.11 Offline UPS .....	11
<b>4.FAQs</b> .....	12
<b>5.Troubleshooting</b> .....	12
<b>6.What's in the Box</b> .....	13
<b>7.Storage &amp; Maintenance</b> .....	13

# 1. Specifications

<b>General</b>	
Weight	≈ 46.5lbs / 21.2kg
Dimensions	17.5 × 10.5 × 13.8in / 446 × 276 × 352mm
Capacity	2,096Wh (44.8Ah/46.8V)
Wi-Fi	Supported
Cell Network & GPS	Supported
<b>Outputs</b>	
AC (6*)	Pure Sine Wave, rated 2,000W (surge 4,000W), 110V~50/60Hz (US, JP version) or 220-240V~50/60Hz (Other versions)
USB-C (4)	USB-C1/2: 5-20V, 100W Max Each USB-C3/4: 5-12V, 20W Max Total
Car Charger (1)	13.6V $\overline{\text{---}}$ 10A, 136W** Max
DC5521 Output (3)	13.6V $\overline{\text{---}}$ 10A, 136W** Max Total

\* The EU version has 4 AC Outlets

\*\*136W refers to the combined maximum output power of the Car Outlet and the DC5521 ports together.

<b>Inputs</b>	
AC Charge	1,800W Max, 100-120V~50/60Hz (US, JP version) or 220-240V~50/60Hz (Other versions)
Solar Charge	12-60Vmp DC, 600W Max via XT60 input 60-160Vmp DC, 1,800W Max via AC input
Car Charge	Supports 12V/24V $\overline{\text{---}}$ 10A Battery
<b>Battery</b>	
Cell Chemistry	Li-NMC
Warranty	2 years
Cycle Life	3,000 cycles to 60%+ capacity

<b>Temperature</b>	
Optimal Operating Temperature	59°F to 95°F (15°C to 35°C)
Discharge Temperature	-4°F to 104°F (-20°C to 40°C)
Charge Temperature	32°F to 104°F (0°C to 40°C)
Storage Temperature	32°F to 110°F (0°C to 45°C)

## 2. Safety Guidelines

### 2.1 Usage

- 1.Store product in a cool and dry place.
- 2.Do not dispose of the product in heat or fire.
- 3.Do not expose to moisture or submerge it in liquid.
- 4.Do not use around strong static electricity or magnetic fields.
- 5.Do not disassemble the product. Consult official Zendure channels when service or repair is required. Incorrect disassembly or reassembly may result in a risk of fire or injury to persons.
- 6.When using the product, please strictly follow the operating environment temperature range specified in the user manual. If the temperature is too high, it may result in a fire or explosion; if the temperature is too low, the product performance may be severely reduced, or the product may cease to work.
- 7.Do not block or obstruct the fan during use or place the product in an unventilated or dusty area.
- 8.Ensure the product is not hit, dropped, or heavily vibrated. Securely fasten the product when transporting to avoid damage. If severely damaged, turn off the power source immediately and discontinue using the product.
- 9.If you accidentally drop the product into water during use, please place it in a safe open area, and stay away from it until it is completely dry. The dried product should not be used again and should be properly disposed of according to the Disposal Guide section of this manual.
- 10.Only clean the ports with a dry cloth.
- 11.Place on a flat surface to keep the product from falling over. If the product is overturned and severely damaged, turn it off immediately, place the battery in an open area, keep it away from people and combustibles, and dispose of it in accordance with local laws and regulations.
- 12.Keep out of reach of children and pets.

## 2.2 Disposal Guide

1. When possible, fully discharge the battery before disposing of it. Consult your local laws on battery recycling and disposal.
2. If the battery cannot be fully discharged due to product failure, contact a professional battery recycling company for further processing.
3. When disposing of secondary cells or batteries, keep cells or batteries of different electrochemical systems separate from each other.

## 3. Getting Started

### 3.1 Interface

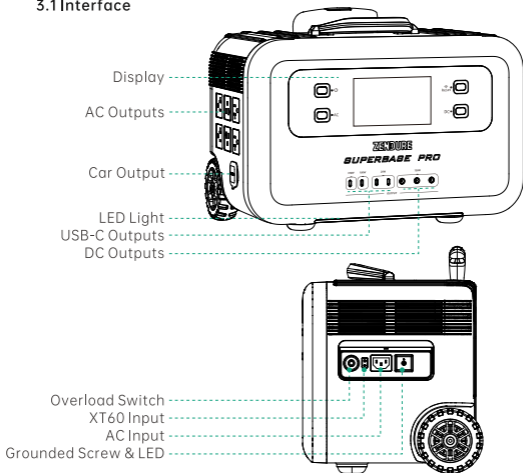

### 3.2 Display

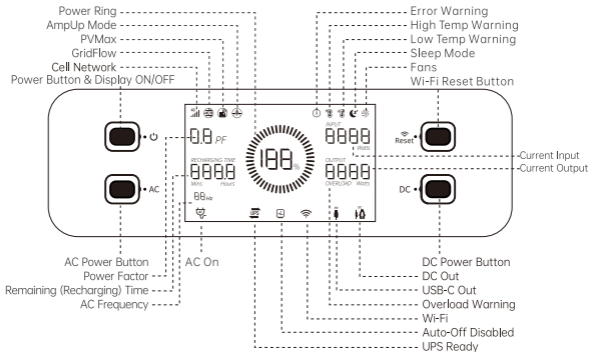

Power Ring Indicator	The ring fills up as the battery is charging. If the product is at 5% charge or less, the ring will flash.
Wi-Fi Status	After the Wi-Fi Reset Button has been pressed for 3 seconds, the Wi-Fi icon will flash to indicate the product is ready for pairing. Connect the product with the app, either by (1) finding the product on your phone's Wi-Fi connections or (2) connecting the product to the internet. If the former, the icon will keep flashing; if the latter, the icon will remain on constantly.
Cell Network Status	After the DC Power Button has been pressed for 3 seconds, the cell network icon will flash to indicate the product is connecting to a mobile network. If there is no network available, the icon will keep flashing; after a successful connection, the icon will remain on.

### 3.3 General Product Usage

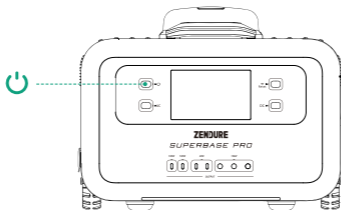

Press for 1s to Turn On, Long Press for 3s to Turn Off

#### Startup, Power Off, Display On

Press the Power Button for 1 second to turn on the product; the Display will light up and the power ring indicator will display.

The Display will automatically turn off after 1 minute of idle operation. You can change this through the Zendure App. When the product senses any load change or other changes to its operations, the Display will automatically light up.

To power off the product, press and hold the Power Button for 3 seconds. The default product standby time is 1 hour. With other buttons turned off and no other load access for 1 hour, the product will automatically shut down. The standby time can be set in the Zendure App.

## AC Output Port

With the device powered on, briefly press the AC Power Button. The AC Power indicator will illuminate. Briefly press the AC Power Button again to turn it off.

To change 50Hz or 60Hz, press and hold the AC Power Button for 3 seconds. The default standby time of the AC Output port is 1 hour. Without any load for 1 hour, the AC Power will automatically turn off.

Please turn off AC Output power when not in use to reduce energy consumption.

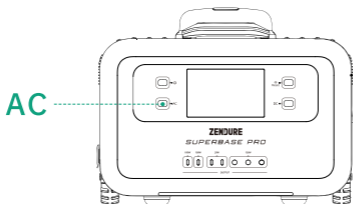

## DC Output Port

With the device powered on, briefly press the DC Power Button. The DC Power indicator will illuminate. Briefly press the DC Power Button again to turn it off.

The default standby time of the DC Output port is 1 hour. Without any load for 1 hour, the DC Power will automatically turn off.

Please turn off DC Output power when not in use to reduce energy consumption.

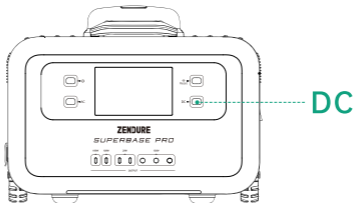



### 3.4 AC Recharging

Zendure's GridFlow fast charge technology is specifically for AC recharging, offering 1,800W of maximum input power. This limit can be modified in the Zendure app. In case of unusual situations where the AC input current remains higher than 20A, the AC input port will initiate a self-protection function, and the Overload Switch on the product will automatically pop up. After confirming that there is no product failure, you can press the Overload Switch to resume charging.

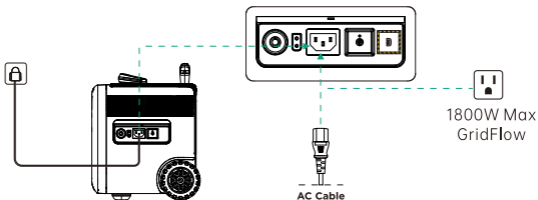

You can set the charging power in the Zendure App. Please use the AC Charging Cable included in the package for fast charging. Do not use other cables to charge. Plug directly into an AC wall outlet and make sure that the wall outlet and circuit are rated for more than 15A. Otherwise, reduce the unit charging speed via the Zendure App. Zendure assumes no responsibility for any consequences of product misuse, including but not limited to charging with an unsuitable wall outlet, circuit, or power cable.

### 3.5 Solar Recharging

Users can connect solar panels in series as shown in the figure to recharge the product. The product supports 12-160Vmp DC input, 11A max current, and 1,800W max charging power.

#### 600W Max via XT60 Input Port, 12-60Vmp DC

XT60 Connector

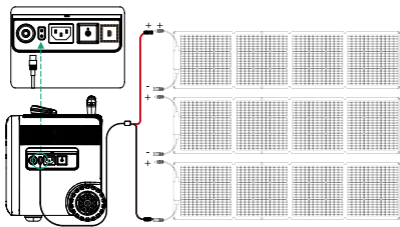

MC4 Connector

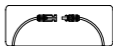

#### 1,800W Max via AC Input, 60-160Vmp DC, PVMax

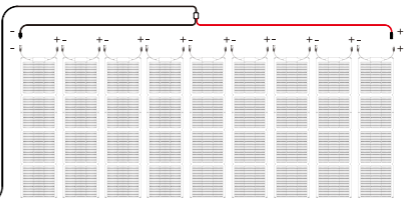
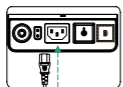

MC4 Connector

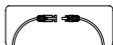

When using Zendure 200W Solar Panels (sold separately) to charge the product, please follow the instructions that come with the solar panels. Before connecting a solar panel, please ensure that the solar panel's output voltage is within 75Voc via XT60 input or 200Voc via AC input to avoid damaging the product.

### 3.6 Car Recharging

Users can recharge the product through the car cigarette lighter socket. This product supports 12V/24V car chargers with a 10A default charging current.

Please recharge using the car charger only while the car's engine is running, to avoid draining your car's battery. In addition, please make sure that the cigarette lighter port of the Car Outlet and the Car Charger Input Cable (not included) are in good condition. Zendure assumes no responsibility for any loss, damage, or injuries caused by misuse.

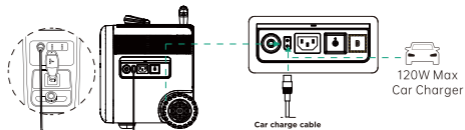

### 3.7 Using Cell Network & GPS

To activate or deactivate the cell network connection, press and hold the DC Power Button for 3 seconds. This will also activate GPS services. You can manually turn off the cell network or GPS services in the Zendure App.

The signal strength of cell networks and GPS services can vary. If you have any questions, please contact the Zendure team for support.

### 3.8 Zendure App

The Zendure App gives users the ability to control and monitor their Zendure power stations remotely.

Read the Zendure App user guide and access the download link here: <https://app.zendure.com/download>



### Privacy Policy

By using Zendure Products, Applications and Services, you consent to the Zendure Terms of Use and Privacy Policy, which you can access via the "About" section of the "User" page in the Zendure App.

### 3.9 AmpUp Mode

With Zendure AmpUp technology, the product can power a 3,000W max device while the rated output power remains 2,000W, avoiding operation failure due to overload protection.

You can turn on AmpUp Mode in the *Zendure App*.

AmpUp Tips:

1. AmpUp is not available when the AC output is turned on in a recharging state (in bypass mode).
2. AmpUp is not applicable for all electrical appliances; it's incompatible with appliances that have strict voltage requirements and a rated power over 2,000W. Appliances with voltage protection (such as precise instruments) are not supported. AmpUp mode is more suitable for heating devices. When using AmpUp with an untested device, please monitor its performance for any irregularities.

### 3.10 Sleep Mode

With Sleep Mode activated, SuperBase Pro will reduce the input power, deactivate the ambient light, and turn off all sounds.

You can turn on Sleep Mode in the *Zendure App*.

Any changes to input power setting, light, sound or standby time of the display will deactivate Sleep Mode.

### 3.11 Offline UPS

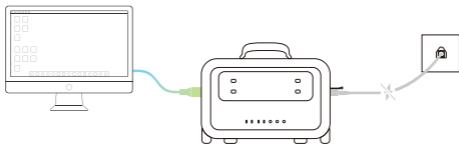

This product supports offline UPS. When you connect the grid power to the AC Input Port of the product through an AC cable, you can power electrical devices through the AC Output Port (AC power will come from the grid and not the power station in this situation). In case of a sudden blackout, the product can automatically switch to the battery-powered supply mode within 13ms. As an offline UPS, this function does not support 0ms switching. Please do not connect the product to any device that requires 0ms UPS, such as data servers and workstations. Please test and confirm compatibility before using the product as a UPS. We recommend that you only charge one device at a time and avoid using multiple devices simultaneously to avoid triggering overload protection. Zendure assumes no responsibility for any device failures or data losses caused by misuse of this product.



## 4. FAQs

1. What kind of battery does this product use?  
This product uses high-quality Li-NMC batteries.
2. What devices can the product's AC output port power?  
With 2,000W rated power and 4,000W peak power, the product's AC output port can power most household appliances. Before you use it, we recommend that you confirm the power requirements of your appliances and ensure the total power of all loaded appliances is lower than the rated power.
3. How long can the product charge or power my devices?  
The remaining discharge time is shown on the product's Display, which can be used to estimate the charging time of most appliances with stable power usage.
4. Can the firmware be upgraded?  
The firmware including ARM, DSP, IoT and BMS can be upgraded online through Zendure App.
5. How do I clean the product?  
Please gently wipe it with a dry, soft, clean cloth or paper towel.
6. How should I store the product?  
Before storing, please turn off the product, then store it in a dry, ventilated place at room temperature. Do not place it near water sources. For long-term storage, please discharge the battery to 30% and recharge it to 60% every three months to extend its battery life.
7. Can I bring the product on a plane?  
No, this product is not permitted aboard aircraft.

## 5. Troubleshooting

Indicator (Flash)	Issue	Troubleshooting
<i>OVERLOAD</i>	Overload Protection	Normal operation will be resumed automatically after you remove the overloaded device and restart the product. Electrical appliances should be used within rated power.
	High Temperature Protection	It can be resumed automatically after the battery cools down.
	Low Temperature Protection	It can be resumed automatically after the battery temperature rises above 32°F (0°C).
	Error Warning	Contact Zendure Customer Service for further information

## 6. What's in the Box



SuperBase Pro 2000



Quick Guide



Warranty Card



Accessory Pouch



MC4 to XT60 Cable 3m



AC Cable 1.5m



MC4 to AC Cable 3m



USB-C to USB Adapter

## 7. Storage & Maintenance

1. Ideally, use and store the product between 59°F and 95°F or 15°C and 35°C, and always keep it away from water, intense heat, and sharp objects. Do not store in temperatures above 110°F (45°C) or below 32°F (0°C) for an extended period.
2. Storing a battery with a low charge for a long period shortens its lifespan. SuperBase Pro mitigates the damage by putting the battery into hibernation mode. To get the most out of the battery, make sure it is about 60% charged before putting SuperBase Pro into long-term storage. Once every three months, discharge the battery to 30% and recharge it back to 60%.