

ZOOZBIKES™

THE ULTRA URBAN

Assembly Guide and User Manual

*QR Code for Assembly Video Inside.

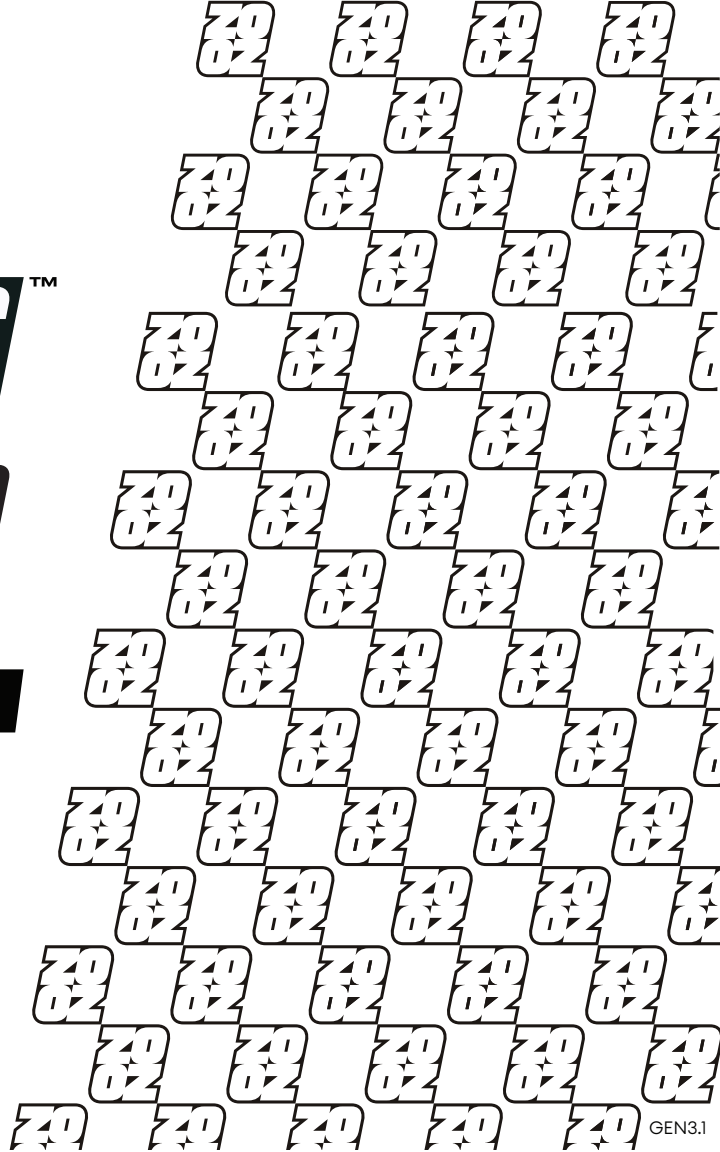

It's Official, YOU are a #ZOOZER

In order to properly operate your ZOOZ Ultra Urban, you must thoroughly read the owner's manual to become familiar with your bike's controls, features, capabilities and limitations. It is the owner and rider's responsibility to ride within the limits of their capabilities and to abide by local laws and regulations. We recommend wearing a helmet when riding for your safety whether or not it is required by your local laws.

This manual is intended to ensure safe and proper function of your ZOOZ electric bicycle. However, it is intended to serve as a general guideline, not a substitute for best bicycle practices, proper care and good judgment. If you are unfamiliar or unsure of the assembly, adjustment and use of this bike, it is strongly encouraged that you find a professional bicycle shop to perform such assembly and maintenance. Just like any other bike, your ZOOZ will need proper adjustment and systematic checks regularly. You should routinely perform these checks, especially if the bike is getting heavy use.

Please check your country or state's regulations on electric bikes before riding. There are variations on age limit, speed, motor wattage and road accessibility. Visit this website for more information:
www.peopleforbikes.org/electric-bikes/policies-and-laws

No liability or warranty shall be accepted if the use of the ZOOZ Bikes electric bicycle deviates from this intended use, if safety instructions are not observed, in the event of overloading, or if faults are not properly rectified. Similarly, no liability and warranty shall be accepted in the case of assembly errors, willful intent, accidents and/or if care and maintenance specifications are not followed. Any modifications or alterations to the electrical system (tuning) voids all claims under warranty and guarantees. Your ZOOZ Bikes electric bicycle is designed for use on paved paths only. You should therefore never ride on stairs, jump, or perform wheelies or similar activities. ZOOZ Bikes electric bicycles are not approved for participation in competitions. Commercial use does not form part of the intended use. Operation parameters, maintenance, guidelines and service instructions described in this manual are part of the intended use.

If you have any questions or concerns, please contact support@zoozbikes.com

The 2023 Ultra Urban Key Features

PATENTED DESIGN US D938, 313 S

SEAT.

Low seat height offers a neutral, upright riding position that allows the rider to sit in a natural place, forward or rearward depending on rider size.

BATTERY.

18650 Lithium-ion cells with an industry standard housing and mounting system. Removeable. Can be charged on or off the bike.

THROTTLE.

Power on demand thumb throttle.

DISPLAY.

Critical bike information with bluetooth connectivity.

CABLES.

Throttle, display, brakes and cut-off sensors. Water resistant cable connections and components.

TAIL LIGHT.

Safety brakelight is always active and becomes a running light when the headlight is on.

FRAME.

4130 chromoly steel is lightweight, absorbs road shock and delivers superb ride feel.

MOTOR.

Three punchy and powerful motors to choose from.

WHEELS & TIRES.

Lightweight double wall aluminum wheels with reinforced spoke eyelets. Round tire profile and sticky rubber offers maximum traction for fast, high lean cornering.

CRANKSET.

Bottom bracket/crankset now feature a 24mm hollow steel thru-spindle, a 4-bolt chainring & integrated chainguard. Redesigned pedal assist cadence sensor.

PEDALS.

Durable black polycarbonate.

BRAKES.

Mounting positions for ZOOZ front and rear racks.

NUMBERPLATE.

Number plate included on all models

HEADLIGHT STEM.

370 Lumen LED integrated into the aluminum stem.

RACK MOUNTING.

Mounting positions for ZOOZ front and rear racks.

ACCESSORY MOUNTS.

4 accessory mounts on the downtube.

CHARGER.

110 v Li-ion Battery.



SEPARATE ITEMS IN THE BOX.

Charger, Pedals, Battery Keys, Battery Stickers & Number Plate.

Assembly Guide & Proper Upkeep

SCAN THIS QR CODE FOR A STEP-BY-STEP ASSEMBLY GUIDE VIDEO.



Before you ride.

Be aware that bikes need maintenance and upkeep periodically. It is recommended to check all bolts and test all mechanical components before each ride.

The more intense you ride, the more attention you should give to the proper function of the bike.

E-bikes experience more wear and tear than normal bikes because of their weight and higher speeds.

Ride responsibly.

⚠ Warning: This bike must be assembled by a professional for proper and safe function. Improper unpacking and assembly can cause damage to the bike and/or bodily harm and is not covered by the ZOOZ Bikes warranty.

Assembly Technical Information.



Assembly Video.

Scan the QR Code with your phone to see our assembly video on YouTube.

Assembly Tip.

Hand tighten hardware initially, adjust and align your parts, then torque to the correct specs.

Tools

Torque Specifications

Hex Wrenches.

3 mm (Display & Throttle)

4 mm (Brake Perch & Rear Brake Light)

5 mm (Seat End Bolts & Brake Mounts)

6 mm (Stem Light & Crank Arm Bolts)

Hand Tighten (*do not over tighten)

8 Newton Meters

12 Newton Meters

23 Newton Meters

Wrenches.

8 mm (Axle Adjusters & Controller)

15 mm (Front Axle)

21 mm (Rear Axle)

8 Newton Meters

60 Newton Meters

60 Newton Meters

Specialty Wrenches.

15 mm Pedal Wrench

5 mm Short Hex Socket (Optional to Long Ball End)

5 mm Long Ball End (Seat Middle Bolts)

40 Newton Meters

12 Newton Meters

12 Newton Meters

Additional Info.

Tire Pressure

Chain Lubricant

Brake Fluid

Pedals

35 psi (softer ride) to 45 psi (more efficient roll)

Standard Chain Lube (always remove excess lube)

Any Certified Bicycle Mineral Oil (*Not DOT Brake Fluid)

Labeled 'L' and 'R'. (*L has reverse threads. Tightens forward)

Assembly Guide

⚠ Warning: This bike must be assembled by a professional for proper and safe function. Improper unpacking and assembly can cause damage to the bike and/or bodily harm and is not covered by the ZOOZ Bikes warranty.

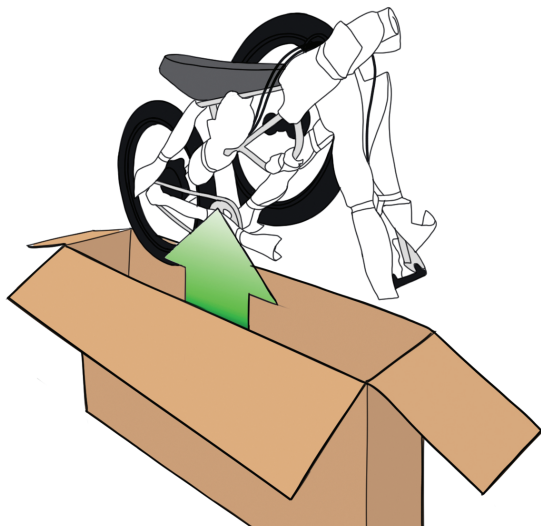

STEP 1

Open box. Be careful to not to damage you the bike or hurt yourself with any sharp tool. Locate and remove smaller box containing the charger. The bike will be mostly assembled inside the bike box with the front wheel and handlebars strapped to the frame of the bike. Lift the bike out of the box with another person's assistance. Carefully remove the zip ties and foam from the bike. Set the front wheel to the side. Damage occurring from unboxing or assembling is not covered in the warranty. Please have a professional assemble the bike.

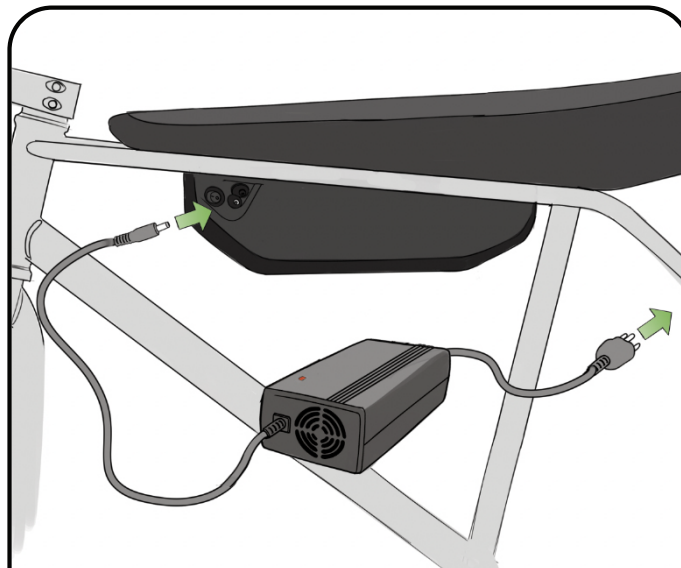

STEP 2

Unbox the charger and battery. Plug the charger into any standard wall socket, then plug the other end of the charger into the battery port, which has a rubber plug that can be flapped open next to the power switch. The light on the charger will turn red when plugged in and not completely charged. Charge the battery until the light turns green before taking your first ride. Indicator lights on the side of the battery display general charge when battery is removed from the bike. Battery charge indicator lights on the side of the battery will only work when the power switch is on. A red blinking light indicates an error.

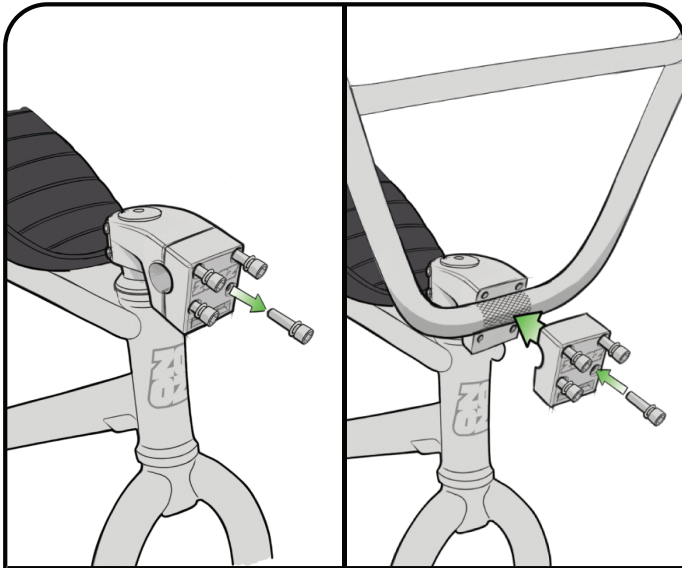

STEP 3

Hold the bike steady in an upright position on a soft floor surface to avoid scratching the frame or fork. Unscrew the 4 bolts from the top of the handlebar stem and remove the stem clamp. Position the handlebars with the knurling centered inside the handlebar clamp. Make sure that the control cables are not tangled, twisted, or kinked. Position the handlebars at an upright angle with a slight rearward or forward angle as per your preference. Tighten the handlebar clamp so the gaps of the clamp in the front and the rear of the clamp are equal. Give a gentle tighten on the handlebar clamp bolts for now. We will return to these bolts during adjustment and torquing.

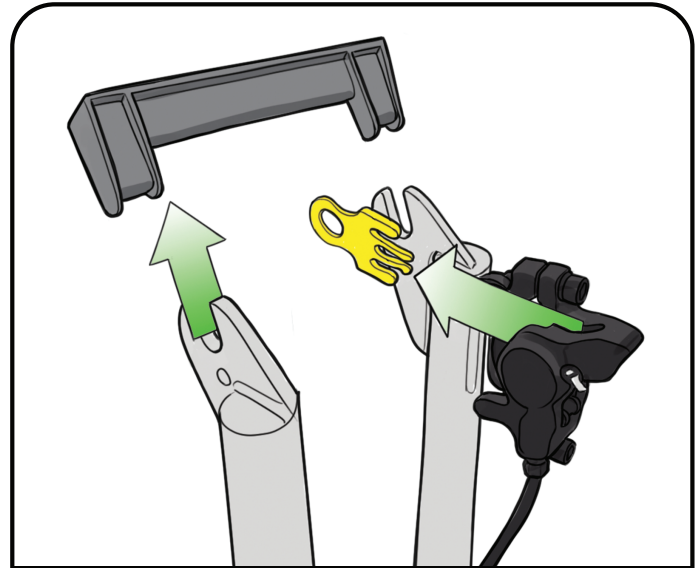

STEP 4

Remove the plastic brake caliper spacer and axle brace. Be sure not to squeeze the brake while the clip or the wheel is removed. If you have accidentally done this, use the brake caliper clip to gently spread the brake pads inside the brake caliper. Prepare the front wheel axle for mounting by removing the front axle nuts, flat washers and hook washers.

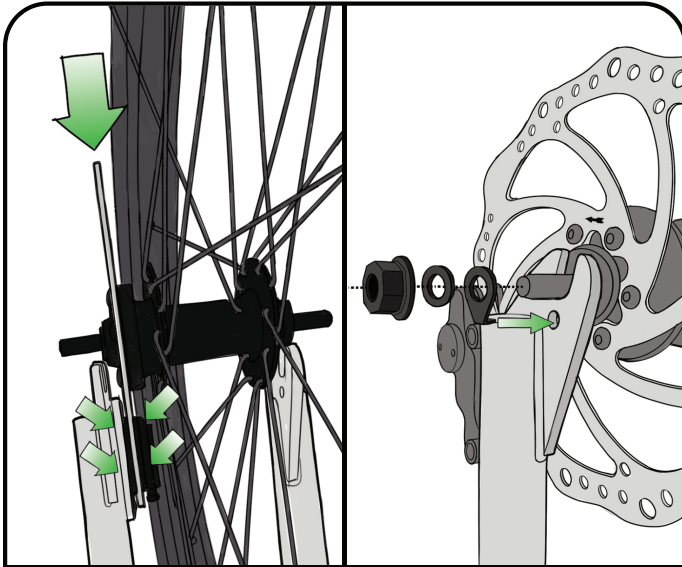

STEP 5

Lift the bike from the handlebars to lower the forks onto the front axle and guide the disc into the brake caliper and the axle slots into the axle plates. This is easiest to do with the help of another person. Slide on the hook washers so that the hook is seated in the small hole on the axle plate. Slide the flat washer on next, then thread the axle nut on by hand and give a gentle tighten with a 15mm closed-end wrench. We will return to these bolts during adjustment and torquing.

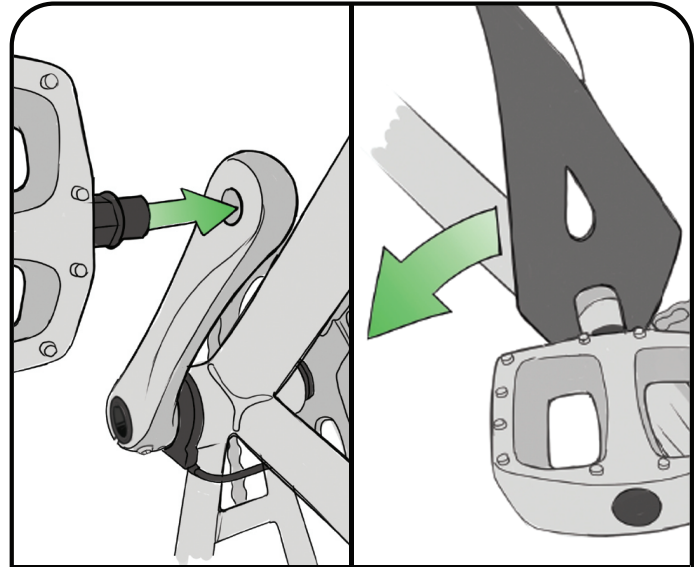

STEP 6

Each pedal screws into the crank arms with threads that spin in the opposite direction. Identify the pedals for each side by finding an R and L stamped on the threaded spindle of the pedals. Thread them onto the crank arms by hand. Rotating the pedals toward the front of the bike will tighten the pedals. Once threaded, tighten with a 15mm open-end wrench to tighten snugly. We will return to the pedals during adjustment and torquing.

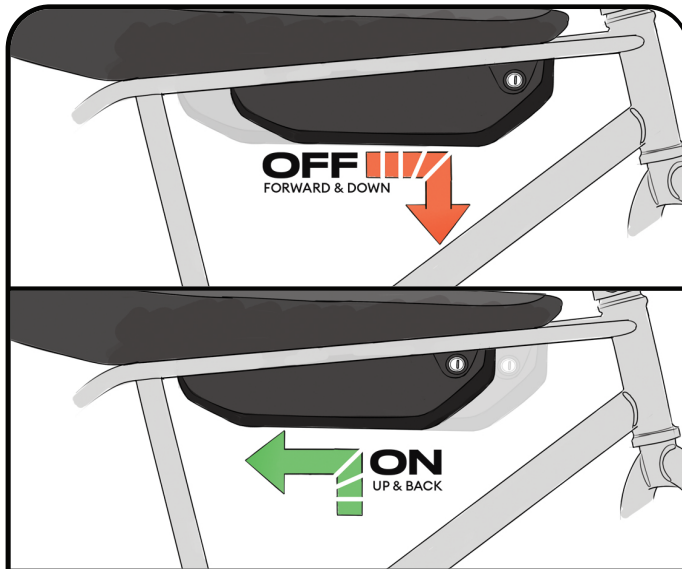

STEP 7

At times, it will be necessary to remove the battery; for cleaning, replacement or charging in small spaces. To do so, insert and turn the key 180 degrees into the “unlock” position. Grasp the battery in the middle and tug forward to slide it off. When placing the battery back on the bike, reverse the process, placing the battery at the front of the mounting plate and ensuring the tongue-and-groove is fully engaged, and slide it back. Give it a good tug rearwards to make sure it's fully seated. Insert and turn the key back to the locked position to secure it. It should be effortless to turn the key. If it's not turning easily, it means the battery is not properly seated. Remove it and try again.



Stop

The bike is now assembled, but you will need proper adjustment and systematic checks regularly, especially if the bike is getting heavy use. You should routinely perform the following checks in the following ‘Adjustment & Torquing’ section of this manual. Checking all bolts before each ride is highly recommended.

Adjustment & Torquing

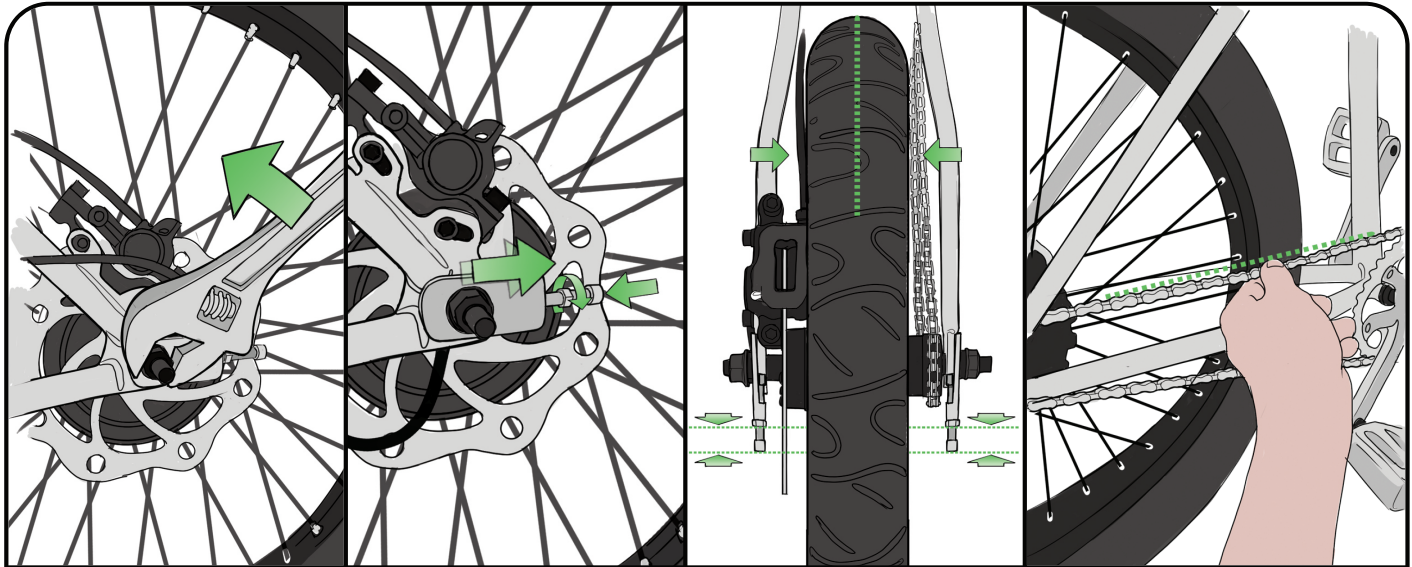

REAR WHEEL ALIGNMENT, CHAIN ADJUSTMENT

Rear wheel alignment and chain tension should be checked often. Electric bikes sustain higher speeds and forces than standard bikes. Movable/adjustable parts can move more frequently than regular bikes. Make sure that the rear wheel is properly aligned by equalizing the spaces between the rear wheel/tire and the frame on either side using the adjusters. You must also make sure that there is chain tension for proper function. To do this, slightly loosen each axle nut on the rear axle and the lockout nut on the adjusters until the axle slides freely in the axle slot. Align rear wheel while maintaining chain tension by tightening the adjuster bolts incrementally on each side. After the axle is in the right position, tighten the adjuster lock nuts then tighten axle nuts to 60 newton meters. The rear tire should be pressurized to fit rider weight and terrain. Lower pressures help smooth out rough terrain and provide more traction on some surfaces. 30-35 PSI for normal road terrain and rider 120-180 lbs. Add more PSI up to the maximum recommended pressure labeled on the side of the tire for heavier riders as needed. Visually inspect the chain and all mechanical parts daily and lubricate as necessary. Using standard chain lube periodically will keep your chain clean, quiet and functioning properly. Wipe away excess lube, grease and oil to prevent dirt buildup.

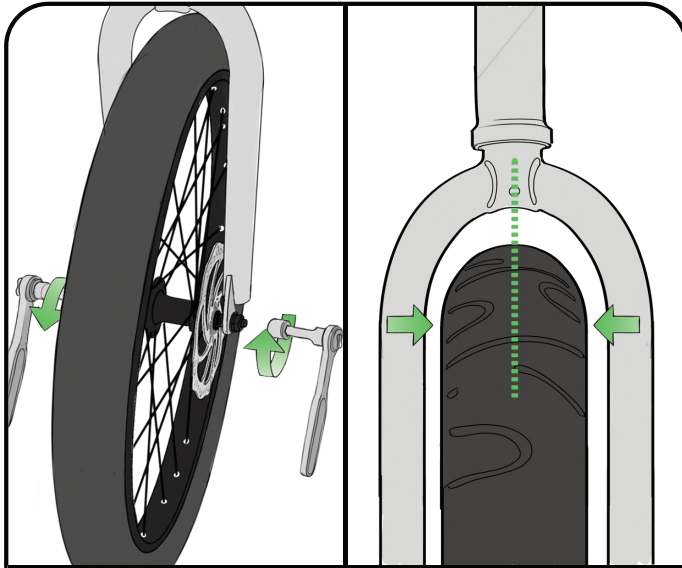

FRONT WHEEL ALIGNMENT

The front wheel should not ever come loose under proper assembly and torquing. However, you should be sure that the axle is completely settled in the axle slots, hook washers are in place and the axle nuts are torqued to 60 newton meters. The front tire should be pressurized to fit rider weight and terrain. Lower pressures help smooth out rough terrain and provide more traction on some surfaces. 30-35 PSI for normal road terrain and rider 120-180 lbs. Add more PSI up to the maximum recommended pressure labeled on the side of the tire for heavier riders as needed.

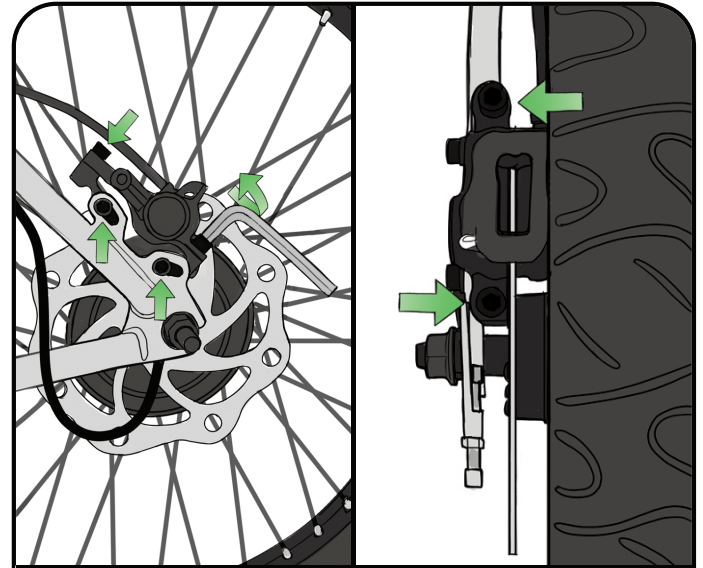

BRAKE CALIPER ALIGNMENT

Brake caliper alignment/adjustment. It is common to get some noise from brake discs if not perfectly aligned and in proper working order. This can occur after heavy use. Loosen the adjustment bolts and lightly position the brake caliper on the disc. An easy method to do this is to lightly hold the brake lever to center the brake caliper on the disc. Then tighten the bolts incrementally up to 12 newton meters. This can take a couple tries and may take some manual/eyeball adjustment. The brake caliper mounting brackets (frame/fork to brake caliper bracket) should always be securely tightened to 12 newton meters.

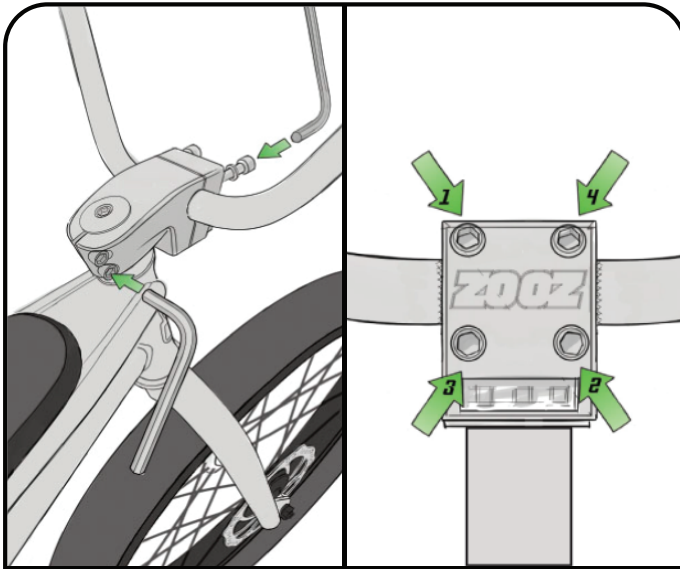

STEM, FORK, HANDLEBAR

This controls your handlebar alignment and must be snugly fitted for safe riding. The steerer tube and stem must be tight and exhibit no "play" or wobble in the steering head. You can check this by loosening the bolts on the side of the stem and tightening the cap bolt to pull the "stack" of steering bearings and spacers together. Do not over-tighten the cap bolt, but the stack of bearing and spacers on the steerer tube should be tight. Ensure that the stem is aligned with the front wheel. Once aligned, re-tighten the stem bolts that clamp the steerer tube. Now check alignment and angle of the handlebars and then tighten handlebar clamp bolts. All bolts on the stem should be torqued to 23 newton meters.

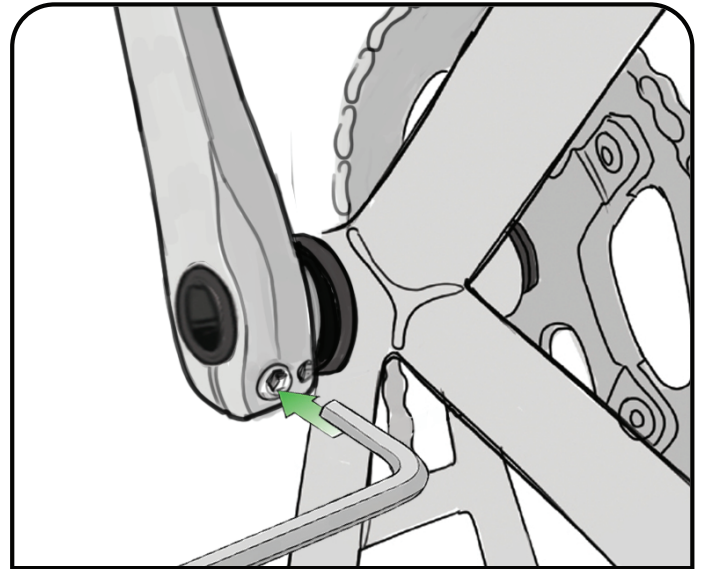

CRANK BOLTS

Crank bolts should be checked and torqued often to 23 newton meters. Apply light grease whenever re-assembling. Do not over tighten for risk of stripping the bolts.

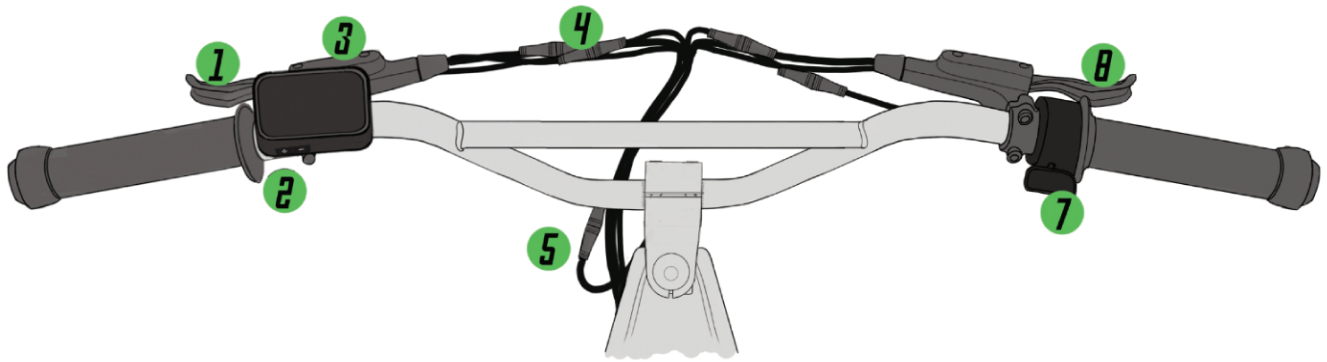

CONTROLS

Each control unit - brake levers, throttle and display have bolts that tighten to secure their position on the handlebar. You can loosen these bolts to adjust the angle of these controls and align them to a position that you find comfortable, but should make sure they are tightened to where they don't move during use. Hand tighten! Do not over-tighten.

- | | |
|--------------------------------|-------------------------|
| 1) Front brake lever | 5) Headlight connector |
| 2) Display | 6) Rear master cylinder |
| 3) Front brake master cylinder | 7) Throttle |
| 4) Control connectors | 8) Rear brake lever |



Ready to Ride!

SHOW US HOW YOU ZOOZ!

#FEELTHETHRILL

Wheels and Tires.

The ZOOZ Bikes electric bicycle has 24" x 2.5" tires and tubes that are designed for durability and safety for regular cycling activities. However, tires must be checked before each use for proper inflation and condition. We recommend 30-35 PSI. Proper inflation, good maintenance, and proper care will ensure proper performance. Check the condition of the tires and rims for damage, cracks, cuts or deformation. When tire wear becomes obvious or a hole in the tire is found, you must replace the tires and/or tubes before using the bike, otherwise injury to operators and/or damage to your bike could occur. In addition to proper inflation, correct wheel alignment helps to decrease tire wear. If you find a tire is worn unevenly, have a professional cycle mechanic check the wheel alignment.

Safety.

A properly fitting ANSI, SNELL, CE, or similarly approved bicycle safety helmet should be worn at all times when riding your bicycle, or as recommended per your local laws. Always wear a properly-fitted helmet that covers the forehead when riding a bicycle. Many states require specific safety devices. It is your responsibility to familiarize yourself with the laws of the state where you ride and to comply with all applicable laws, including properly equipping yourself and your bike as the law requires.

Reflectors are important safety devices that are designed as an integral part of your bicycle. Federal regulations require every bicycle to be equipped with front, rear, wheel and pedal reflectors and/or lights. These reflectors are designed to pick up and reflect street lights and car lights in a way that helps you to be seen and recognized as a moving bicyclist. Check reflectors and their mounting brackets regularly to make sure they are clean, straight, unbroken and securely mounted.

No liability or warranty shall be accepted if the use of the ZOOZ Bikes electric bicycle deviates from this intended use, if safety instructions are not observed, in the event of overloading, or if faults are not properly rectified. Similarly, no liability and warranty shall be accepted in the case of assembly errors, willful intent, accidents and/or if care and maintenance specifications are not followed. Any modification or alterations to the electrical system (tuning) voids all claims under warranty and guarantees.

Your ZOOZ Bikes electric bicycle is designed for use on paved paths only. You should therefore never ride on stairs, jump or perform wheelies or similar activities. ZOOZ Bikes electric bicycles are not approved for participation in competitions. Commercial use does not form part of the intended use. Operation parameters, maintenance, guidelines and service instructions described in this manual are part of the intended use.

Be careful to replace grips and/or bar ends that have been damaged as bar tube ends have been known to cause injury. Do not allow children to ride the bike if damage has occurred until it has been restored to original condition. Although ZOOZ Bikes have water resistant wiring connectors, excessive water and weather can damage electrical components. Limit riding and exposure in wet environments.

Battery Usage and Care Details.

The battery is the most important component of your ZOOZ Bikes electric bike. Following a few simple rules, you can optimize its life:

- The battery can be charged both mounted on the bike or separately from the bike. Two keys are supplied to lock/unlock and remove the battery.
- Plug the charger into a wall outlet. Connect the charger cable to the battery charging port. The battery will charge with the battery switch on or off.
- When the charging process starts, the charger LED turns red. Once the battery is charged, the LED will turn green.
- Do not store a discharged battery. It could go into deep discharge which will reduce its life.
- Make it a habit to recharge at the end of each ride, so your bike will always be ready to ride again.
- Even if it can withstand storage temperatures of 23°F - 104°F (-10°C - 40°C), you can optimize its shelf life by storing it at room temperature 65°-75°F (18° - 23°C).
- Observe operating conditions between 40°F - 85°F (4°C - 30°C).
- Do not leave your battery exposed to high temperatures or direct sunlight for long periods of time (for example, on the back of a car in direct sunlight).
- Please ensure that the contacts are always clean and do not insert any metal objects.
- Do not dispose of the battery in your trash. There are proper disposal methods for lithium-ion batteries. Please check your local waste management regulations.
- Keep out of reach of children.

Brake Wear and Care.

Brakes are an integral part of the operation of your bike and must be properly maintained, adjusted and replaced if necessary. If any of the below is not within your skill set we recommend taking your bike to an E-bike specialist or professional cycle mechanic. Hydraulic brakes require maintenance not only on the pads and rotors but also on the hydraulic brake line. For brake pad replacement, check to see if the rotor and pads have contact with each other. You can purchase replacement brake pads directly from ZOOZBikes.com

The ZOOZ Bikes electric bike brake orientation is as follows:

Rear brake = Right Lever

Front brake = Left Lever

On a hydraulic disc brake, pad wear is compensated for automatically. Simply check the alignment of the pads with the disc, and check that the wheel is fully pushed back. Good alignment ensures the absence of noise and a normal wear of the pads. To ensure maximum service life of the brake components, avoid contamination of the pads and the disc by greasy substances. Regularly check the condition of your cables, ducts or harness, and the wear of your pads. For better ergonomics and safety, we advise you to adjust the brake levers in a position that places it as a natural extension of the user's arms. If you have any questions or concerns, please contact ZOOZ Bikes.

Range.

The maximum range of a full charge depends on many variables such as: age of battery, type of terrain and incline, rider weight, speed, outside temperature, driving style, amount of pedaling and tire pressure.

Range in cold weather:

- In case of extreme cold, the range of your electric bike is reduced. It is a normal physical process, and in no way a sign of damage or defect of the battery. If you use your battery when temperatures rise, its energy will increase again.
- We advise you to store the battery and charge it at room temperature during cold days. The power consumption warms the battery and you benefit from a good battery life, even when it is cold outside. In winter, plan for shorter trips or pedal with a lower level of assistance.

Conditions that affect your battery's range:

- Temperature: Extreme cold and heat can affect the battery's capacity.
- Total Number of Charge Cycles: The battery has a total of 600 - 800 full cycles when it's new.
- As the battery ages, total capacity can decrease.
- Wind: Riding into a strong headwind can decrease range.
- Road Conditions: Excessively rough or hilly terrain requires the consumption of more power.
- Load: Carrying extra cargo on the bike or in a backpack will use more energy.
- Rider Weight: The weight of the rider can affect the energy usage of the bike, with more weight requiring more energy.
- Repeated acceleration from a standing start.
- Poor Maintenance: Issues like under-inflated tires, mal-adjusted brakes and a dry or dirty chain can decrease range.

Tips for Maximizing Range:

- Charge the battery at a comfortable temperature range between 65°F - 75°F (18.3°C-23.9°C).
- Lithium-ion batteries have no chemical memory, and it is not necessary to discharge the battery completely for the best performance. Charging a partially-full battery will have no negative effect.
- Maintain proper tire pressure and lube the chain regularly.
- Operating temperatures between 40°F - 85°F (4°C - 30°C) will significantly increase range.

Display, Interface and Features.

Display Definition.

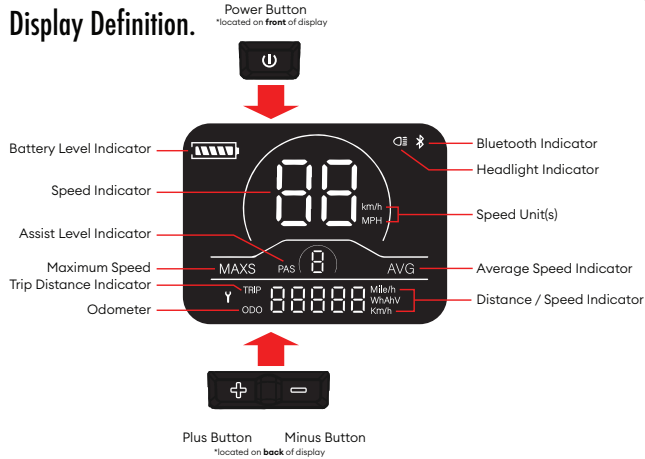

Button Definition.

The YL81C display has a three button interface. **U** (Power), **+** (Plus), and **-** (Minus). It will light up for night visibility when buttons are pressed.

Normal Operation.

Press-hold the **U** (Power) button for 2 seconds, the display turns on and opens the circuit between the battery and the controller making the system active and ready. The display will automatically power off after 10 minutes of no use or button interaction which also shuts down the entire system.

NOTE: Inactivity for more than 5 seconds in any screen, any mode, the screen will automatically go back to the default screen real-time speed and trip distance.

Display Interface.

Press/hold **U** button to power on. Display 1 (trip distance) is the default screen.

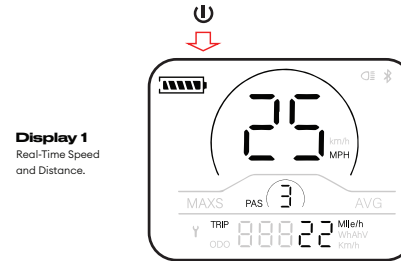

In display 1, press **U** button to enter display 2, press again for display 3 and 4.

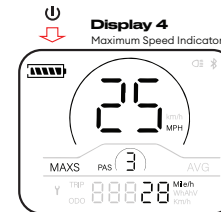
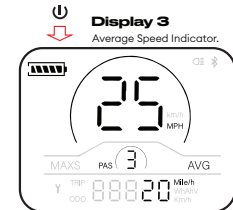
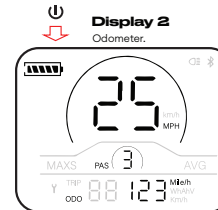

Pedal Assist.

The ZOOZ Urban Ultralight has both throttle and pedal assist power delivery options. Pedal assist is a feature that adds power to assist the rider when peddling the bike. There are five pedal assist levels, 1 (minimum) through 5 (maximum). You can also turn pedal assist off by adjusting down to 0.

The throttle is always dominant, so whether or not you are using the pedal assist and you press the throttle, the power level will switch to the throttle level.

At any time when the system is powered on, you can adjust the pedal assist level by pressing the **+** (Plus) or **-** (Minus). Adjusting the pedal assist while pedaling is normal.

No matter what display screen you are in, the pedal assist indicator is active and will display your current level.

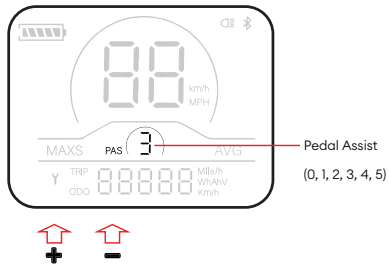

NOTE: By default, the system will reset PAS to level 1 every time it is powered on.

Headlight, Taillight and Display Light.

The ZOOZ Urban Ultralight is able to turn on the taillight, display light and headlight *if equipped at any time when the system is powered on.

Press and hold the **+** (Plus) button until the headlight display light comes on. The headlight indicator light will also appear on the display.

The lights will stay on as long as the system is powered on. To turn the lights off, press hold **+** (Plus) again until the display light and indicator shuts off.

NOTE: Whether or not the lights are on, the taillight will always illuminate when either brake lever is pulled.

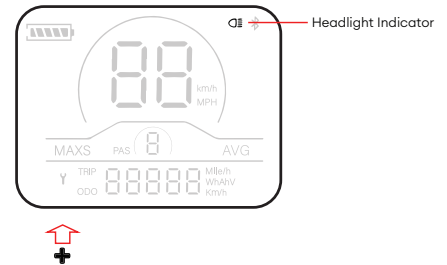

Battery Level.

The battery level indicator is located at the top of the screen and is always visible, no matter what screen you are in. There are five level indicators inside a frame in the shape of a cell battery. All five level indicators and the frame are shown when the battery is full. When the battery is empty the frame will flash indicating power failure.

The five level indicator percentages are as follows:

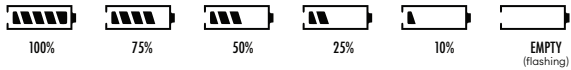

Battery Level Indicator

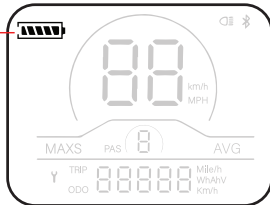

Trip Distance.

The trip distance is able to be cleared to zero at any time. If you do not clear the trip distance, it will keep adding distance from each ride just like the odometer.

To zero the trip distance press and hold the **⏻** (Power) and **-** (Minus) buttons at the same time for 2 seconds and it will reset to 0.

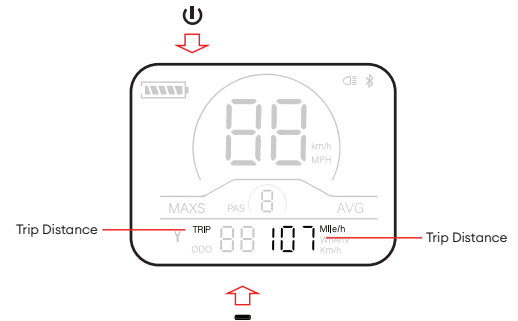

Metric / Imperial Units. (Km/h, MPH)

Your bikes default unit setting is imperial (Mph) but can be changed to metric (Kp/h) easily through the display.

To change the unit setting, press and hold **+** (Plus) and **-** (Minus) buttons at the same time for 2 seconds to enter into the 'P' settings mode. Once you see P1 on the display single-press the **U** (Power) button until you see P4 (cycle past P1, P2, P3). Then Press **+** (Plus) or **-** (Minus) buttons to choose between 00 (Metric-Kp/h) and 01 (Imperial - Mph).

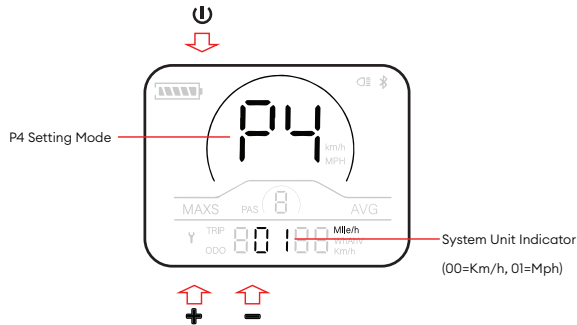

Speed Limit.

You can limit your bike's maximum speed if you desire. The default settings for each power level are set to achieve its maximum legal speed.

To change the maximum speed limit, press and hold **+** (Plus) and **-** (Minus) buttons at the same time for 2 seconds to enter into the 'P' settings mode. Once you see P1 on the display single-press the **U** (Power) button until you see P3 (cycle past P2). Then Press **+** (Plus) or **-** (Minus) buttons to adjust the speed limit number up or down.

Note: The speed limit number is always shown as km/h vs MPH.

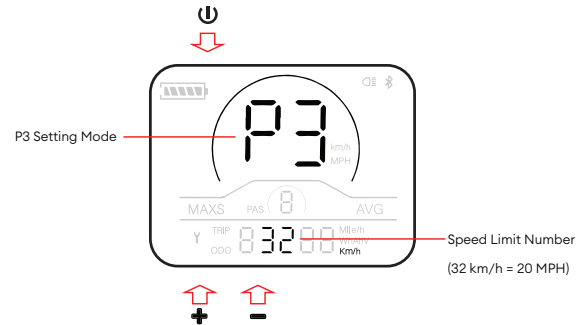

Now, go
FEEL THE THRILL
you crazy kids!



LIMITED WARRANTY

FEEL THE THRILL Co.

COVERING ALL MODELS, THEIR ACCESSORIES AND PARTS

Each new electronic bicycle sold by ZOOZ BIKES ("FEEL THE THRILL Co.," "us," "we," or "our") comes with a Limited Warranty (as defined below) for the original retail purchaser. PROOF OF PRODUCT REGISTRATION AND ORIGINAL PURCHASE RECEIPT IS REQUIRED FOR VALID WARRANTY COVERAGE.

1. Warranty. Subject to the terms, conditions and limitations herein, FEEL THE THRILL Co. warrants to the original retail purchaser of the bike that (i) the frame, fork and electronics of the bike will be free from defects in material and workmanship under normal use and service for one (1) year from the date of delivery, and (ii) the battery will be free from defects in material and workmanship under normal use and service for two (2) years from the date of delivery or 500 life cycles, whichever comes first (the "Limited Warranty"). The Limited Warranty exists for abovementioned defects that were already present at the time of delivery of the bike and covers the battery, motor, controller, display and sensors. Like any rechargeable battery, your FEEL THE THRILL Co. rechargeable battery pack will experience a decrease in capacity over time as it is subjected to charge and discharge cycles. FEEL THE THRILL Co. warrants that your battery pack will maintain 70% or higher capacity for at least 500 charge cycles or two years, whichever comes first. The battery warranty does not include damage from power surges, use of an improper charger, water damage, improper maintenance, or such other misuse or normal wear. This warranty is only valid for the first buyer. Any other remedy, such as compensation for damages of any kind or loss of use, is excluded. The warranty period cannot be extended by granting an additional warranty.

2. Remedies. If the original retail purchaser notifies FEEL THE THRILL Co., authorized dealer or the retail location from where the bike was purchased of a warranty claim within the applicable warranty period set forth above, FEEL THE THRILL Co. will evaluate the warranty claim. The purchaser will be responsible for shipping the bike and/or required parts to the location notified by FEEL THE THRILL Co.. If FEEL THE THRILL Co. determines that the defective part is covered by the Limited Warranty, FEEL THE THRILL Co. will replace or repair the defective part, at FEEL THE THRILL Co.'s sole discretion, without charge to the buyer and also reimburse the shipping cost incurred by the purchaser. If the defective part is not covered by the Limited Warranty, FEEL THE THRILL Co. will repair or replace the defective part at the purchaser's cost and the purchaser will also be responsible for the shipping costs.

3. Requirements for this Limited Warranty to apply.

- (a) The original purchaser provides proof that the bike was purchased from FEEL THE THRILL Co. or one of its authorized dealers or distributors.
- (b) The person seeking warranty coverage is the original and first owner of the bike (warranty is not transferable in the case of a re-sale).
- (c) The bike was used in accordance with its intended purpose. The FEEL THE THRILL Co. bike is intended for use on paved road in compliance with all local laws and regulations.
- (d) The electronics including connectors and cables have not been repaired or modified.

pg1 of 4

4. Exclusions. This Limited Warranty does not cover the following:

- (a) Normal wear and tear of the product.
- (b) Damage or failure from abuse, neglect, misuse, or accident.
- (c) Damage from off-road or stunt riding, ramp jumping, acrobatics or similar activities or any activity that is not consistent with the intended use of the bike.
- (d) Damages resulting from improper charging of the battery pack or use of any charger not supplied by FEEL THE THRILL Co. or its dealers.
- (e) Rust or damage surfaces during handling
- (f) Installation of any third-party parts, accessories, or electrical or mechanical components.
- (g) Any components that have been modified or tampered with, including but not limited to tires, brake pads, chains, lights, motors, battery packs, displays, controllers, etc.
- (h) Damage associated with commercial use or rental operations.
- (i) Lost or damaged keys.
- (j) Damage caused by stunt riding, racing, or other abusive treatment.
- (k) Product that has the serial number, bar code, warning labels or seal indicating stockers of any and all parts removed, defaced, damaged, altered or made illegible.
- (l) Any defects or damages caused by actions that are inconsistent with any guidance or warnings set forth in any owner's manuals or product instructions.
- (m) Products purchased or used outside the United States.
- (n) If the bike is used for any purpose other than the reasonable intended use of the bike.
- (o) If electrical parts have been repaired or modified by a person not authorized by FEEL THE THRILL Co.. This is a consumer warranty and does not apply to products used commercially or in rental operations.

5. Wear and Tear. Some components of your bike are subject to wear owing to their function. The extent of wear depends on the care, maintenance and nature of the use of your FEEL THE THRILL Co. product (mileage, climate and road conditions, etc.). Bikes that are often left outside can also be subject to increased wear due to weathering. For safety, the parts must be replaced once they reach their wear limit. This includes but is not limited to:

- (a) The drive chain or toothed belt;
- (b) The brake cables;
- (c) The brake pads;
- (d) The brake disc rotors;
- (e) The rubber hand grips;
- (f) The sprockets, pinions, or toothed belt discs;
- (g) The gear cables;

pg2 of 4

- (h) The tires;
- (i) The saddle cover;
- (j) The rims;
- (k) The bearings in the headset, hubs, and bottom bracket.

The brake pads and disc rotors are subject to wear owing to their function. Check the condition of the pads regularly and, if necessary, have them replaced by a specialist dealer. Brake disc rotors also wear out. Regularly have the thickness of the brake disc rotors checked as part of inspection and replace the components, if necessary. Replacing these parts due to wear, is not subject to the statutory warranty. Environmental factors cause wear on these moving parts. These areas must be regularly cleaned and maintained. Depending on the operating conditions, it cannot be ruled out that parts will have to be replaced due to wear (e.g. if bearing play starts to occur). You must contact your dealer before arranging repairs in order to ensure the quickest and most cost-effective way to deal with your issue. Shipping and disassembly instructions from either the dealer or FEEL THE THRILL CO. must be followed. Otherwise warranty service will not be provided. Failure to comply with the assembly specifications and inspection intervals can void the warranty and liability for defects. Parts which must be replaced due to wear are not covered under this Limited Warranty.

6. Other Limits to this Limited Warranty. *There are no other warranties by either party, expressed or implied.*

(a) EXCLUSIVITY OF WARRANTY. THIS LIMITED WARRANTY IS THE FULL EXTENT OF FEEL THE THRILL CO.'S RESPONSIBILITIES AND THE CUSTOMER'S SOLE AND EXCLUSIVE REMEDY AGAINST FEEL THE THRILL CO. WHETHER BASED UPON WARRANTY, STATUTE, CONTRACT, TORT (INCLUDING NEGLIGENCE, STRICT LIABILITY OR ANY OTHER THEORY OF LIABILITY), INDEMNITY, MISREPRESENTATION OR ANY OTHER BASIS. THIS LIMITED WARRANTY IS THE SOLE WARRANTY MADE BY FEEL THE THRILL CO. REGARDING THE BIKE AND IS IN LIEU OF ALL OTHER WARRANTIES, CONDITIONS AND REMEDIES, WHETHER WRITTEN, ORAL, STATUTORY OR IMPLIED, INCLUDING, BUT NOT LIMITED TO, THE IMPLIED WARRANTIES OR CONDITIONS OF MERCHANTABILITY, MERCHANTABILITY QUALITY, FITNESS FOR PARTICULAR PURPOSE AND THOSE ARISING BY STATUTE OR OTHERWISE IN LAW OR FROM THE COURSE OF DEALING OR USAGE OF TRADE. FEEL THE THRILL CO. DOES NOT REPRESENT OR WARRANT THAT THE BIKE (OR ANY COMPONENT THEREOF) WILL MEET ANY OR ALL OF THE CUSTOMER'S PARTICULAR REQUIREMENTS. THE CUSTOMER ACKNOWLEDGES AND ACCEPTS THAT ANY TERMS AND CONDITIONS INCONSISTENT WITH THE TERMS OF THIS LIMITED WARRANTY THAT MAY BE CONTAINED, OR REFERRED TO, IN ANY STANDARD TERMS AND CONDITIONS OF PURCHASE OF THE CUSTOMER (OR ANY OTHER DOCUMENT OR WRITING PRODUCED BY OR ON BEHALF OF THE CUSTOMER, INCLUDING WITHOUT LIMITATION, PURCHASE ORDERS, CONFIRMATIONS AND SPECIFICATIONS) ARE EXPRESSLY REJECTED AND EXCLUDED. THE CUSTOMER FURTHER ACKNOWLEDGES THAT IT IS NOT RELYING ON ANY STATEMENTS, REPRESENTATIONS OR WARRANTIES MADE BY ANY INDIVIDUAL ACTING ON BEHALF OF FEEL THE THRILL CO. AS SUCH INDIVIDUAL, WHETHER EMPLOYEE OR AGENT, IS NOT AUTHORIZED TO MAKE STATEMENTS, REPRESENTATIONS OR WARRANTIES THAT EXCEED THOSE SET FORTH IN THIS LIMITED WARRANTY. NOTHING IN ANY ASSEMBLY INSTRUCTION, PRODUCTION INFORMATION OR ADVERTISEMENTS IS INTENDED TO CREATE OR BE CONSTRUED AS AN EXPRESS WARRANTY OF ANY KIND WITH RESPECT TO THE BIKE. NO AGENT, EMPLOYEE, DEALER, REPRESENTATIVE OR RESELLER IS AUTHORIZED TO MODIFY OR EXTEND THIS LIMITED WARRANTY OR TO MAKE BINDING REPRESENTATIONS OR CLAIMS, WHETHER IN

ADVERTISING, PRESENTATION OR OTHERWISE. THE LIMITATIONS AND DISCLAIMERS CONTAINED IN THIS BASE WARRANTY MAY NOT BE MODIFIED, ALTERED OR WAIVED BY ANY ACTION, INACTION OR REPRESENTATIONS, WHETHER ORAL OR IN WRITING, EXCEPT IN WRITING SIGNED BY FEEL THE THRILL CO.'S DULY AUTHORIZED REPRESENTATIVE.

(b) LIMITATION OF LIABILITY. TO THE EXTENT PERMITTED BY LAW, IN NO EVENT WILL FEEL THE THRILL CO. OR ITS AFFILIATES, OR ITS AND ITS AFFILIATES' RESPECTIVE OFFICERS, DIRECTORS, EMPLOYEES, LICENSORS, MANUFACTURERS OR SUPPLIERS BE LIABLE TO CUSTOMER, ITS PARENT, SUBSIDIARIES, AFFILIATES OR CUSTOMERS OR ANY THIRD PARTY FOR ANY LOSS OF USE, INTERRUPTION OF BUSINESS, LOSS OF REVENUE OR PROFITS, INTEREST, LOST GOODWILL, WORK STOPPAGE, IMPAIRMENT OF OTHER GOODS, LOSS BY REASON OF SHUTDOWN OR NONOPERATION, INCREASED EXPENSES OF OPERATION, COST OF PURCHASE OF REPLACEMENT PARTS OR VEHICLES OR CLAIMS BY CUSTOMER OR CUSTOMER'S CUSTOMERS FOR SERVICE OPERATION OR INDIRECT, SPECIAL, INCIDENTAL, PUNITIVE, CONSEQUENTIAL, EXEMPLARY, AGGRAVATED OR RELIANCE DAMAGES, HOWEVER ARISING, WHETHER FOR BREACH OF WARRANTY, CONTRACT, STATUTE, TORT (INCLUDING NEGLIGENCE, STRICT LIABILITY OR ANY OTHER THEORY OF LIABILITY), MISREPRESENTATION OR OTHERWISE, EVEN IF FEEL THE THRILL CO. IS MADE AWARE OF THE POSSIBILITY OF SUCH DAMAGES. YOUR RIGHTS MAY VARY FROM STATE TO STATE. SOME STATES AND JURISDICTIONS DO NOT ALLOW LIMITATIONS ON HOW LONG AN IMPLIED WARRANTY LASTS, OR THE DISCLAIMER OR LIMITATION OF INCIDENTAL OR CONSEQUENTIAL DAMAGES, SO THE ABOVE LIMITATIONS AND DISCLAIMERS MAY NOT APPLY TO YOU, AND THEY DO NOT APPLY WHERE PROHIBITED BY LAW.

7. Dispute Resolution. FEEL THE THRILL CO. HAS the sole intention of creating bikes, community and culture. We will do our best to resolve disputes relating to a product or purchase under this Limited Warranty.

YOU AGREE THAT ALL DISPUTES WITH FEEL THE THRILL CO. ARISING IN ANY WAY FROM THIS LIMITED WARRANTY OR THE SALE, VALUE, CONDITION OR PERFORMANCE OF THE PRODUCT MUST BE RESOLVED EXCLUSIVELY THROUGH FINAL AND BINDING ARBITRATION AND NOT BY A COURT OR JURY. BY AGREEING TO ARBITRATION, YOU ARE WAIVING IMPORTANT RIGHTS, INCLUDING, BUT NOT LIMITED TO, THE RIGHT TO A TRIAL BY JURY AND THE RIGHT TO BRING AN ACTION IN A COURT OF LAW OR EQUITY.

The arbitration will be before a single arbitrator, whose award must not exceed, in form or amount, the relief allowed by the applicable law. The arbitration will be conducted in accordance with JAMS consumer arbitration rules and procedures or other arbitration procedures appropriate for use in consumer disputes. The arbitration provision is entered into pursuant to the Federal Arbitration Act, and the substantive laws of the State of Texas, without reference to its choice of law principles, will otherwise govern the interpretation of the Limited Warranty and all disputes that are subject to this arbitration provision. The arbitrator will decide all issues of interpretation concerning this Limited Warranty and the arbitration provision. Any such dispute will not be combined or consolidated with a dispute involving any other persons' or entity's product or claim, and specifically, without limitation of the foregoing, must not under any circumstances proceed as part of a class action or collective action. It is the intent of the parties that any and all disputes will be resolved on an individual basis only, and that the arbitrator will not have the power to award class or collective relief. Customer Inquiries. For all inquiries on warranty and returns, please contact us at: hello@zoozbikes.com.



A COMMUNITY LIKE NO OTHER.

Contact Us.

Home base
Customer Support
General Inquiries
Follow us

www.zoozbikes.com
support@zoozbikes.com
hello@zoozbikes.com
 [zoozbikes](https://www.instagram.com/zoozbikes)



*assembly video link



FEEL THE THRILL

Copyright FEEL THE THRILL Co. 2022