

YOKOTA - AIRTOOLS CATALOGUE - 2007/2008

Airtools

Hoists

Winches

Chisels & drills

Impact sockets

Accessories



www.impulstools.com

Preface

In this catalogue

In this catalogue you will find a survey of our delivery program, ranged by application. The tools are supplied as Yokota, Toku or Red Rooster air tools, Action impact sockets and SMC air treatment equipment. All products are of industrial quality, with exception of the Red Rooster Automotive range. These tools are especially used in (car) workshops. For an extended range of accessories you also can contact us.

Our tools are sold worldwide. Nevertheless we always keep in close contact with our customers. We think it is important to listen to the special requests of our customers and share knowledge and experience. Our worldwide sales- and service network also offers good advantages for exporting companies.



Airtools

- | | |
|---------------|-------------------------|
| Yokota | Air tools |
| Yokota Hi-Tec | Impulse wrenches |
| Toku | Air tools |
| Red Rooster | Air tools |
| Red Rooster | Automotive airtools |
| Red Rooster | Air chain hoists |
| Red Rooster | Winches |
| SMC | Air treatment equipment |
| Action | Impact sockets |

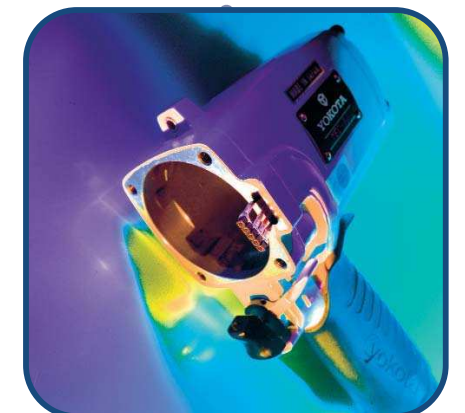

Technical specifications are subject to change without prior notification if necessary. Copyright © 2007 Yokota Europa BV.

Contents

All product groups

Contents



Impulse wrenches



TAG - angle grinders



Quickchange adapters



www.impulstools.com



Ratchet wrenches



Mini sanders

Product group	Page
<ul style="list-style-type: none"> ■ Explanation of brands 4 - 11 ■ Maintenance and use 13 ■ Quality of the air 15 ■ Warranty 17 ■ Guideline values & selection chart 18 - 19 	
1 Impact wrenches	20 - 27
2 Impulse wrenches Double chamber airmotor; lightweight design; shut off; standard; electronic bolt/torque control; battery impulse wrenches; Poka Yoke ⁺ ; system wrenches	28 - 45
3 Ratchet wrenches	46 - 49
4 Screwdrivers	50 - 55
5 Drills	56 - 59
6 Dowel pin pullers	60 - 63
7 Grinders & sanders Die grinders; angle grinders; vertical grinders; straight grinders; orbital-, wire brush-, mini-, beltsanders	64 - 75
8 Hammers	76 - 81
9 Needlescalers	82 - 85
10 Power cutters	86 - 89
11 Saws	90 - 95
12 Special assembly tools Tip dressers; hog ringers; tailor-made tools	96 - 99
13 Various Riveters; engraving pen; caulking gun; multi cutter; blow guns; pumps	100 - 105
14 Air chain hoists	106 - 119
15 Winches	120 - 131
16 Accessories Spring balancers; PU air hoses; kombi-kit; oil; mini-oilers; regulators	132- 137
17 Air treatment equipment	138 - 151
18 Impact sockets Impact sockets; Sleeve drive power sockets; quickchange adapters; extension bars; adapters; sets	152 - 187
19 Chisels & drills	188 - 203
Index	204 - 206
Notes	207 - 208



Yokota Hi-Tec

Yokota Hi-Tec impulse tools are a step ahead. With a range of normal impulse wrenches up to electronic controlled impulse wrenches the tools tighten the joints in an optimal way. The clamp force of the hard and soft joints is high and the relaxation low.

A big advantage of the impulse wrenches is the quick tightening time. This offers the possibility to decrease the assembly time during a process. Impulse wrenches have no kick-back, so they are comfortable to use. The optimal clamp force results in a better end product; the aim of every manufacturer!

Yokota Industrial

Yokota industrial air tools are manufactured to the highest quality. The tools have been developed for continuous use and are used in various industries. The Yokota grinders are produced with patented gears with little play. This is why vibration and wear are minimal.



Toku

Industrial quality tools



Toku

Our Toku program contains a large range of industrial air tools. Each tool is manufactured for long continuous use. The ball-bearings, gears and the air motor are produced with highest accuracy, smallest tolerances and therefore offer the best performance.

As with the Yokota tools, the Toku tools are also manufactured in Japan. In the Toku range you will find a.o. impact wrenches, ratchet wrenches, drills, grinders and hammers, among which paving breakers, clay diggers and rock drills.

The Toku impact wrenches are constructed with a closed hammer or Twin-hammer mechanism. The construction without loose hammerpin prevents pin breakage, while the twin-hammer has a high torque and long lifespan. All pistol models are executed with exhaust through handgrip and nearly all models have an adjustable silencer.

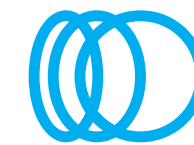

“Moving circle” - Toku’s corporate symbol

The corporate identity symbolizes new born power and the amplification of this new power for growth and development moving towards the new age. The meaning of the 3 circles represent: quality, reliability and continuity. Toku is using this corporate symbol as a flagship to challenge the 21st century. Today, Toku is considered as one of the leading manufacturers for pneumatic tools and hydraulic products in the world, having one of the most advanced production facilities and superior technology.

The automotive and industrial pneumatic tools are traditional products within Toku's product line. As a result of continuous development in this field for technology and design.

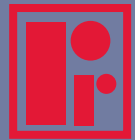

Red Rooster

A big range of applications

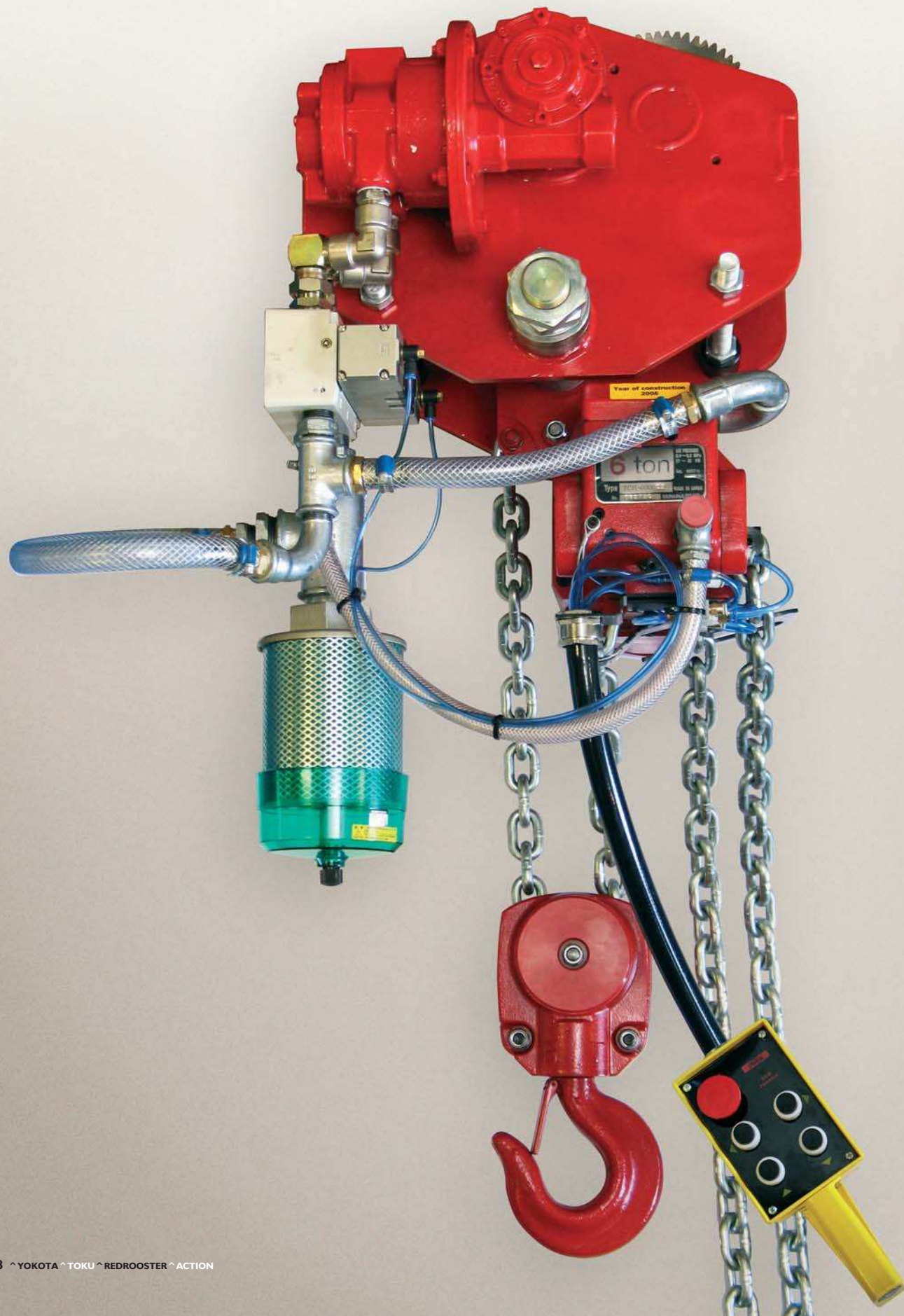

Red Rooster Air tools

Red Rooster is our private label. This selection of tools from various manufacturers, gathered in one brand, completes our program.

Red Rooster Industrial contains for example grinders and drills for continuous use. High quality tools selected from the product range of the best manufacturers.

Red Rooster Automotive covers the automotive after market.

Our Red Rooster program has been changed in the last few years. The number of industrial tools has been increased, while the number of Automotive tools has been decreased. Tools for the Automotive after market, workshops, etc. can be recognized by their type name starting with RRA.

Red Rooster Air chain hoists

The air hoists in our Red Rooster program are available from 0.125 up to 100 tonnes. The hoists are made by Toku and are of high industrial quality. They are in use with several well-known users (see page 107). Red Rooster air hoists can easily be delivered in spark resistant models. Standard with build-in load limiter. With a market share from 70% in Europe we can say that we have an interesting product for an interesting price that is available with short delivery times.

Red Rooster Winches

The Red Rooster winches are available from 0.2 up to 35 tons in electric, pneumatic and hydraulic models.



Action

Power impact sockets and chisels

Action Power impact sockets

Impact sockets for professionals! Action impact sockets are manufactured from the best materials: chrome-molybdenum alloy steel. Action impact sockets are made according to DIN3121 and DIN3129. The exact fitting causes less play between square drive and impact socket, and impact wrench and bolt. This results in a longer life of the tool and impact socket. As reference we have various big car manufacturers.

Sleeve Drive Sockets have been developed by Action at the request of Yokota to improve the quality of a joint tightening with impulse wrenches. Sleeve Drive Sockets have minimized play between socket and tool by reducing "wobble" and stabilizing the torque setting. The use of Sleeve Drive Sockets is not only of benefit to the actual joint but also reduces vibration to the tool and operator, also reducing noise levels and tool wear.



Action Chisels

Action chisels for air hammers are available in a large range. For each application a special size is available, resulting in an optimal power transmittance. For chisels not in this catalogue, please contact us directly. Show us your hammer, we supply you with the right chisel.



Maintenance and use

Air tools



How to use

Please take the following points into consideration before using new air tool(s). We advise you to oil your tool with resin and acid free oil through the air inlet. Check, before connecting the hose to the tool, whether the hose and quick coupler are clean.

Make sure that the air is dry and clean. We advise you to use air treatment equipment and a correctly adjusted lubricator. Use the correct oil (Yokota NO32 air tool oil). For a good lubrication we advise use of a hose between oiler and airtool of max. 8 m. (26 ft.). If you want to use a longer hose, it is possible to mount a SMC jet-oiler. The jet oiler has a reach of approx. 200 m. The air pressure of the tool has to be 0.63 MPa. The correct hose diameter is necessary to achieve the best performance.

Please note

When using impact wrenches and impulse wrenches, the torques shown will vary if used on a soft joint, e.g. washers, gaskets, etc.

Maintenance

Draw water from the air piping and compressor tank daily. Check if the lubricators are filled with (Yokota) air tool oil.



Quality of the air

Optimal functioning of the tool

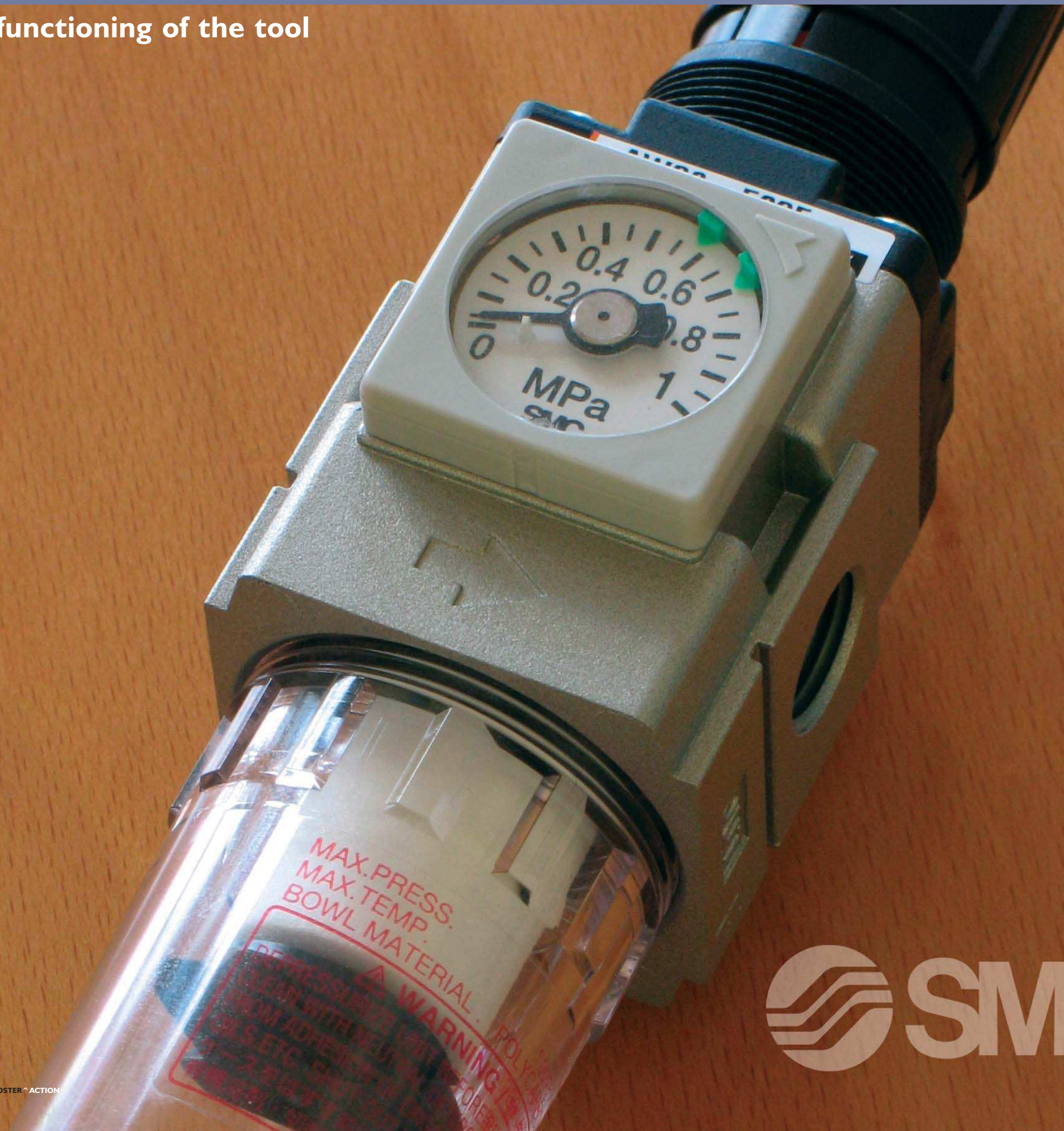

Pressure is too low!

If the pressure is too low the tool will show less performance and less precision, resulting in slow starting and less productivity. 1 bar pressure-reduction means 25% power loss!

Low pressure may occur if:

- The capacity of the compressor is insufficient,
- The air piping has been pitched incorrectly,
- There are air leaks,
- The air treatment equipment is not functioning properly and/or is not pitched correctly,
- The wrong size hose nipples or quick couplers are used,
- The tank is too small.

Quality of the air

Poor air quality can result in expensive production downtime, and will increase the time and costs of maintenance and will shorten the life of your tools.

Good quality air should be a first consideration, cost will earn itself back easily, as it will save your tools from damage.

Poor air quality can be caused by:

- Lack of necessary air treatment equipment,
- Poor quality and/or wrong installation of the air treatment equipment,
- Lack of maintenance of the air treatment equipment,
- Incorrect hose diameter.



Warranty

What you should know!



Warranty period

The warranty period from the date of purchase is as follows:

- 12 months Yokota, Red Rooster and Toku industrial air tools
- 12 months Red Rooster hoists and winches
- 12 months Red Rooster automotive air tools
- 3 months On repairs and replaced spare parts, which are repaired by either us or our official service workshops.

Warranty covers material and / or construction faults of the manufacturer, which are clearly definable. Replacement of parts or repair by an official Yokota/Toku/Red Rooster service workshop is free of charge when the tool is covered by warranty. Freight or postage is for the account of the customer.

Damage attributed to normal wear, overloading or incorrect use is excluded from warranty. Replacement of tools as a consequence of warranty claims is not part of the warranty arrangements.

Also claims for loss of production and/or other damages are excluded from this warranty. Repairs under warranty can only be considered, when the tool is in its original state and it is accompanied by the purchase invoice. Warranty claims have to be made through the distributor, who has supplied the tool concerned. We reserve the right to make unannounced changes to our tools. These warranty conditions are based on an 8 hour working day.



Assembly tools

Guideline values for tightening torques

DIN 267		3.6	4.6	4.8	5.6	5.8	6.8	8.8	10.9	12.9
Bolt	Socket size	Torque Nm	Torque Nm	Torque Nm	Torque Nm	Torque Nm	Torque Nm	Torque Nm	Torque Nm	Torque Nm
M4	7	0.85	1.1	1.5	1.4	1.9	2.3	2.9	4.1	4.9
M5	9	1.7	2.2	3.0	2.8	3.7	4.5	6	8.5	10
M6	10	2.9	3.9	5.1	4.8	6.4	7.7	10	14	17
M8	13	7	9.3	12	12	16	19	25	35	41
M10	17	14	19	25	23	31	37	49	69	83
M12	19	24	32	43	40	54	65	86	120	145
M14	22	39	51	68	64	86	105	135	190	230
M16	24	59	79	105	98	130	155	210	295	355
M18	27	81	110	145	135	180	215	290	405	485
M20	30	115	155	205	190	255	305	410	580	690
M22	32	155	205	275	260	345	415	550	780	930
M24	36	265	350	460	440	580	710	930	1290	1560
M27	41	295	390	520	490	650	780	1050	1500	1800
M30	46	395	530	710	660	880	1050	1450	2000	2400
M33	50	540	720	960	900	1200	1450	1900	2700	3250
M36	55	690	920	1250	1150	1550	1850	2450	3450	4150
M39	60	920	1200	1600	1500	2000	2400	3200	4500	5400
M42	65	1100	1500	1950	1850	2450	2950	3950	5550	6650
M45	70	1400	1850	2450	2300	3100	3700	4950	6950	8350
M48	75	1700	2250	3000	2800	3750	4450	5950	8400	10100
M52	80	2150	2900	3850	3600	4800	5750	7650	10800	12900
M56	85	2700	3600	4800	4500	5950	7150	9550	13400	16100
M60	90	3350	4450	5950	5550	7400	8900	11900	16700	20000
M64	95	4000	5350	7150	6700	8950	10700	14300	20100	24100
M68	100	4850	6500	8650	8100	10800	13000	17300	24300	29100

Please note:
Above torque values are only guidelines and are calculated with friction factor 0.125.

Selection chart

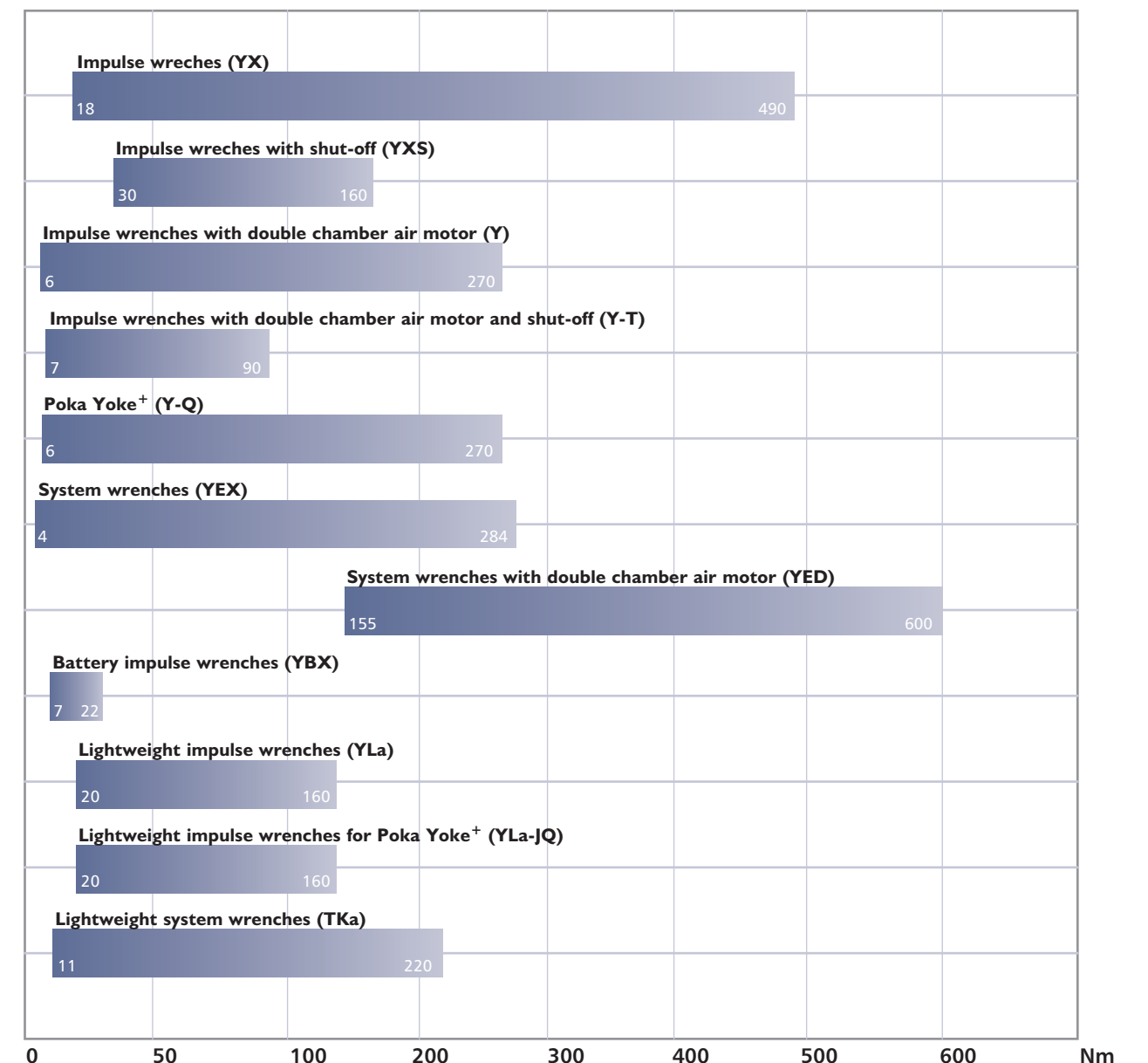
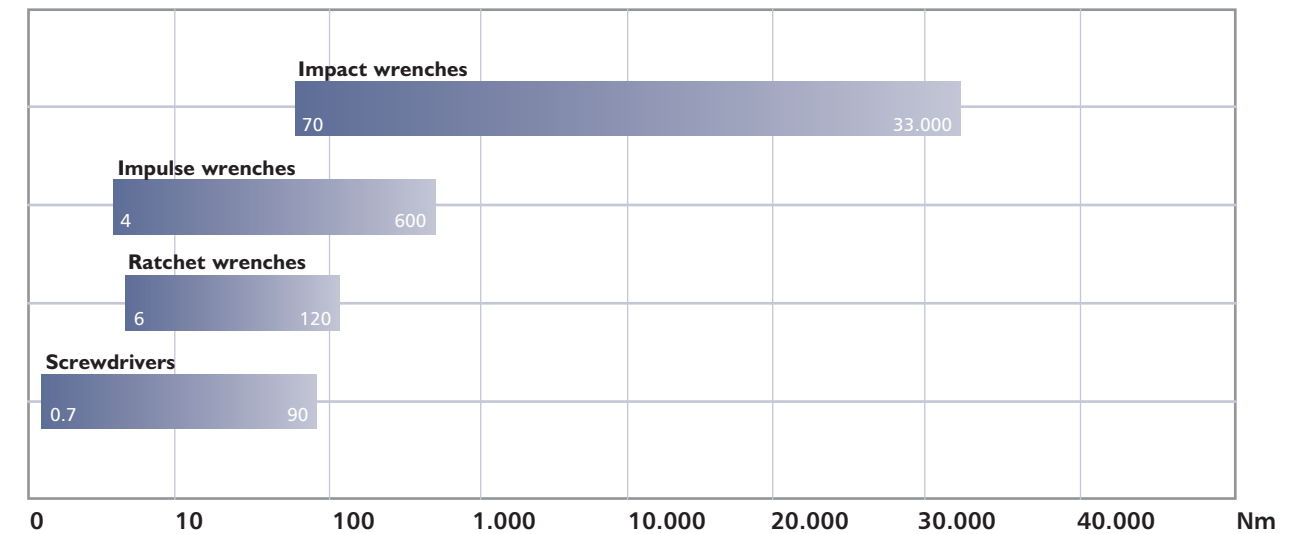

I. Impact wrenches

Application and mechanism



Yokota

The Yokota impact wrenches are used for industrial applications. These heavy duty models are produced with 1 or 2 hammer impact system. For specialised assembly applications we refer to the chapter impulse wrenches.

Toku

The Toku impact wrenches are used for industrial and heavy duty workshop applications. These high quality tools are produced with closed hammer mechanism, or with Twin-hammer mechanism.

Red Rooster

The Red Rooster impact wrenches are used for industrial and heavy duty workshop applications. The tools are produced with twin-hammer or 3-jaw mechanism, suitable for continuous use.

The Red Rooster Automotive impact wrenches are used for workshop applications in intermittent use, e.g. automotive repairshops, etc. Manufactured with 1-hammer mechanism.

Impact wrenches

Applications

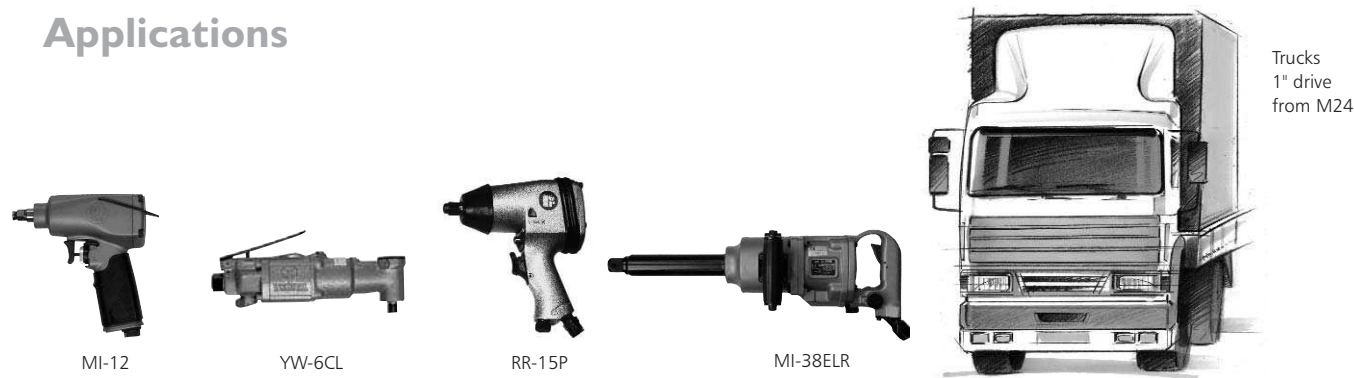

MI-12

YW-6CL

RR-15P

MI-38ELR

Trucks
1" drive
from M24

Nuts and bolts get stuck. Fortunately the impact wrench can untighten any joint without problems and without any major effort from the operator. Most common impact wrench used in garages are 1/2" square drive, and are suitable for nuts and bolts upto M14 - M16. Repairing vans and larger vehicles with bolt sizes of M22 - M24 requires a 3/4" square drive to be used. Lastly the 1" square drive impact wrenches are mainly used in truck and bus workshops. Besides (car)workshops, impact wrenches are also used in other industries for example on shipyards, at construction workshops and in the petrochemical industry.

The right choice

Most makes of impact wrenches look more or less the same. However the prices may differ. This is because of the quality of the impact mechanism. If the tool is only to be used once in a while, then it is advisable that you buy a cheaper model, if however the tool is going to be used more frequently then the industrial models are to be considered. Manufactured with stronger materials and better quality impact-mechanisms, they guarantee a longer, more durable and trouble free lifetime. Cheaper tools are mostly executed with the single hammer impact mechanism. The industrial ones however, have a pin-clutch (Dynamact) or twin hammer system.

Noise, vibration and weight also influence the price. An industrial wrench has a better silencer and less vibration. In tyre workshops where impact wrenches are used continuously, these are the most important factors. Fortunately more and more impact wrenches are executed with a rear exhaust (outgoing airflow through the hand grip), while most of the conventional wrenches have an exhaust which is situated at the front of the tool. This can cause brake dust to be blown into the face of the operator while untightening the wheel nuts. Very uncomfortable!

Torque

Often people think that the torque of an impact wrench is about the same as the performance of the tool. However it is incorrect to compare impact wrenches on torque figures alone, as there is no standard for measuring the torque. The specified torque is depending on various points: impact mechanism, weight, air consumption, quality.

Caution when tightening!

Impact wrenches were designed to untighten fixed joints. In practice they are also often used for the tightening nuts and bolts, but beware! Impact wrenches are, for example, a killer of hard joints. Because of the speed of the tool, the required torque will have been hit and over tightened very quickly. This could have serious consequences when it comes to the legal product responsibility regulations and the ISO certification. The tightening of nuts and bolts should be done by torque adjustable tools (see our impulse wrenches).

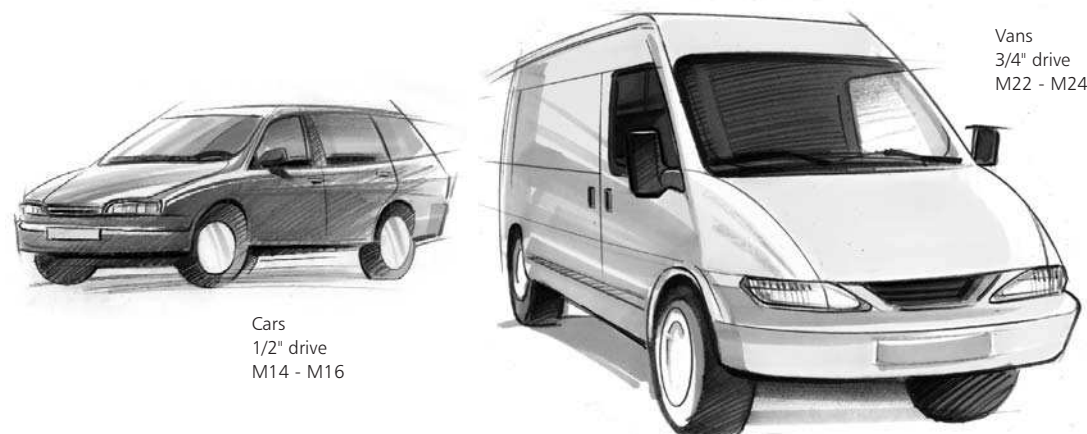

Cars
1/2" drive
M14 - M16

Vans
3/4" drive
M22 - M24

Mechanisms

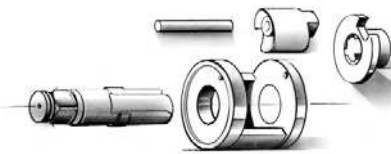

The 1-hammer system makes 1 impact per rotation at 1 side of the anvil. This causes a higher energy per blow. The impact wrenches with the 1-hammer system are especially suitable for disassembly jobs.

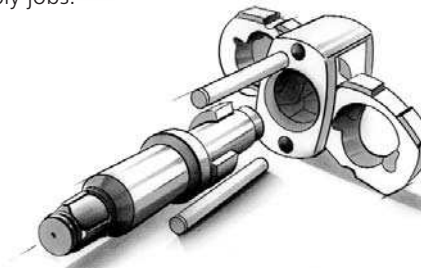

The twin-hammer system makes 2 impacts per rotation at both sides of the anvil. Same principal as the 2-hammer system, manufactured differently.

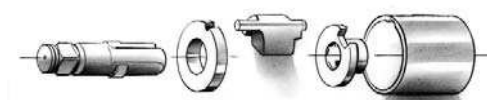

The closed hammer system; this construction, without loose hammerpin, will prevent breakage. The working principle is based on the 1-hammer system.

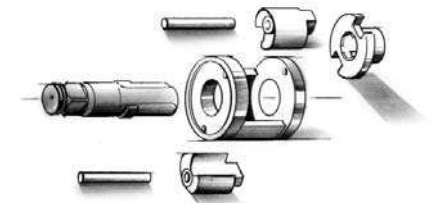

The 2-hammer system makes 2 impacts per rotation at both sides of the anvil.

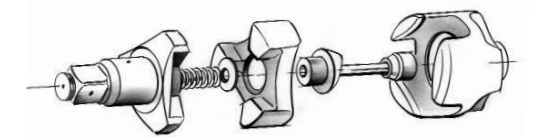

The 3-jaw system gives, per rotation, one impact on all 3 jaws of the anvil. This gives a high torque output. Impact wrenches with the 3-jaw system are *only suitable for hard joints*.

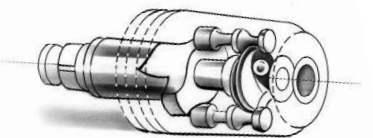

The Dynamact impact system has two pins hammering on the anvil, making 1 impact per rotation at both sides of the anvil at once. The system gives high torque output and is well balanced.

Air consumption

To choose the right compressor one needs to know how much air l/min a machine uses and how the machine will be used, continuously or intermittently. There are 2 ways to estimate the air consumption of air tools:
Method 1 Measure air consumption with continuous operation
Method 2 Measure with intermittent operation

Continuous operation

The total air consumption when the trigger is pulled for a period of one minute (this is what you will find in this catalogue). If you use our machine like this you need a compressor with the capacity stated.

Intermittent operation

The air consumption is measured when the trigger is pulled intermittently for say 25% of a minute, which gives 25% intermittence. If you use your machine like this you need a compressor with 25% of the capacity stated.

Intermittence

The average time that a machine is calculated to be in use during a normal working cycle (1 min.). Intermittence varies between different types of machines, for example a grinding machine is normally in use for long periods and therefore has a high intermittence. An impact wrench is normally used in short bursts and therefore has a lower intermittence.

An example. If at 100% intermittence, the air consumption is 800 l/min then at 25% intermittence the air consumption would be 200 l/min i.e. 25% of 800 l/min.

Impact wrenches

Pistol models

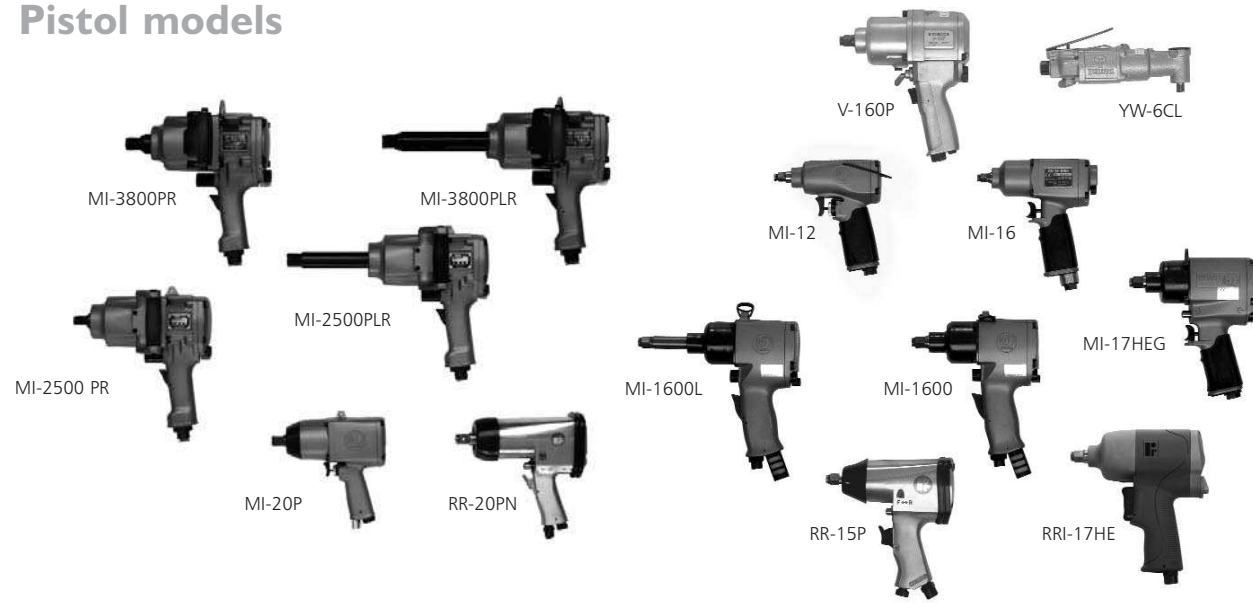

Type	Brand	Square-drive	Type#	Bolt capacity mm	Impact-mechanism	Rotations p/min	Torque Nm	Air-consumption l/sec	Weight kg	Inlet-thread	Hose-diameter mm	Vibration m/s ²	Noise-level dB(A)
YW-6CL*	YOKOTA	3/8"	H	6	1-Hammer	6.500	145	4.2	1.6	PT 1/4"	10	18	81
MI-12	TOKU	3/8"	R	12	Twin-Hammer	9.500	160	5.3	1.2	PT 1/4"	6.5	9.9	82
MI-16 3/8"	TOKU	3/8"	R	12	Twin-Hammer	6.200	270	5.3	1.5	PT 1/4"	9.5	4.6	87
MI-16 1/2"	TOKU	1/2"	R	12	Twin-Hammer	6.200	310	5.3	1.5	PT 1/4"	9.5	4.6	87
RR-15P	RRA	1/2"	-	14	1-Hammer	6.900	430	6.6	2.4	PT 1/4"	10	11	82
V-160P	YOKOTA	1/2"	R	16	1-Hammer	6.500	580	7.5	2.8	PT 1/4"	10	13	84
MI-1600R	TOKU	1/2"	R	16	Closed hammer	7.000	520	8.3	2.6	PT 1/4"	10	9	80
MI-1600	TOKU	1/2"	H	16	Closed hammer	7.000	520	8.3	2.6	PT 1/4"	10	9	80
MI-1600LR	TOKU	1/2"	R	16	Closed hammer	7.000	500	8.3	2.7	PT 1/4"	10	9	80
MI-1600L	TOKU	1/2"	H	16	Closed hammer	7.000	500	8.3	2.7	PT 1/4"	10	9	80
MI-17HEG	TOKU	1/2"	R	16	Twin-Hammer	5.500	650	8.3	2.4	PT 1/4"	9.5	7.4	88
RRI-17HE	RRI	1/2"	R	16	Twin-Hammer	7.000	750	9.8	2.1	PT 1/4"	9.5	4.6	87
MI-20P	TOKU	3/4"	R+H	24	Twin-Hammer	5.000	1.000	9.6	3.9	PT 3/8"	9.5	4.6	92
RRI-1045**	RRI	3/4"	H	20	Twin-Hammer	5.000	1.495	20.0	5.4	PT 3/8"	13	8	94
RR-20PN	RRA	3/4"	R+H	20	1-Hammer	4.800	720	9.2	4.6	PT 1/4"	10	4	87
MI-2500PR***	TOKU	1"	R+H	24	Closed hammer	5.500	1.150	11.7	8.3	PT 3/8"	10	6	86
MI-2500PLR***	TOKU	1"	R+H	24	Closed hammer	5.500	1.100	11.7	9.1	PT 3/8"	10	6	86
MI-3800PR	TOKU	1"	R+H	36	Closed hammer	4.500	2.100	15.0	9.3	PT 1/2"	13	8	84
MI-3800PLR	TOKU	1"	R+H	36	Closed hammer	4.500	2.000	15.0	9.9	PT 1/2"	13	8	84

* YW-6CL has an angled head for working in confined spaces
 ** Also available with 1" square drive / *** Also available with 3/4" square drive
 # Type: R = ring type / H = hole type / R + H = ring + hole type

L = Long anvil

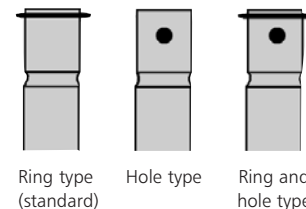

Straight models

Spare parts

Type	Spring ring	O-ring
TOKU 3/8"	13-08-03-092	13-11-01-004
TOKU 1/2"	13-08-03-106	13-11-17-108
TOKU 3/4"	13-08-03-113	13-11-01-013
TOKU 1"	13-08-03-144	13-11-05-013
V-160P	0208-0416-00-00	9010-3005-00-00
RR-15P	40303	40305
RR-20PN	280-016	00-4118
RRI-17HE	13-08-03-106	13-11-17-108
RRI-1051	1051-006-00	

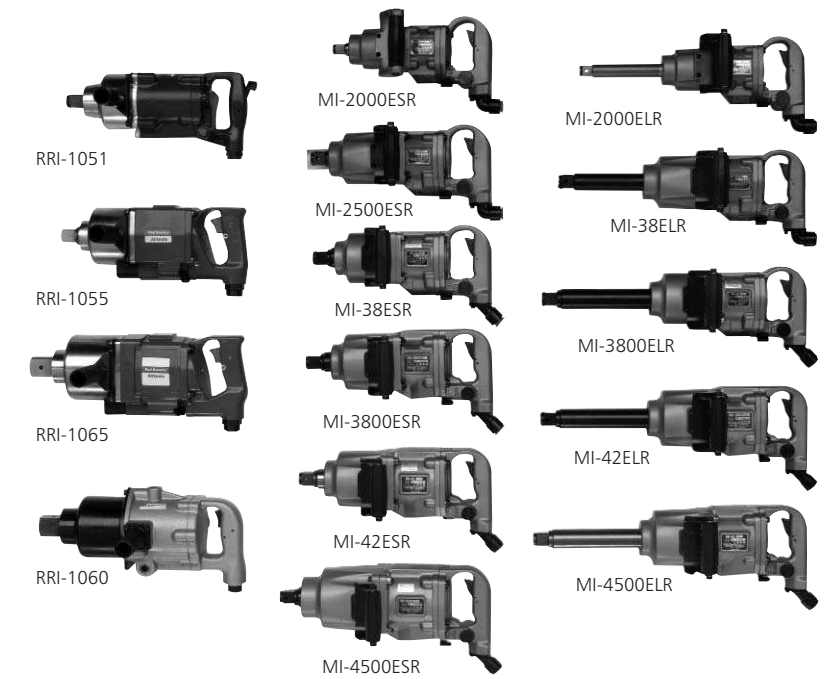

Type	Brand	Square-drive	Type#	Bolt capacity mm	Impact-mechanism	Rotations p/min	Torque Nm	Air-consumption l/sec	Weight kg	Inlet-thread	Hose-diameter mm	Vibration m/s ²	Noise-level dB(A)
MI-2000ESR	TOKU	3/4"	R+H	20	Closed hammer	5.000	775	9.6	5.4	PT 3/8"	10	4	82
MI-2000ELR	TOKU	3/4"	R+H	20	Closed hammer	5.000	725	9.6	5.8	PT 3/8"	10	4	82
MI-2500ESR*	TOKU	1"	R+H	24	Closed hammer	5.500	1.150	11.7	8.3	PT 3/8"	10	6	90
MI-2500ELR*	TOKU	1"	R+H	24	Closed hammer	5.500	1.100	11.7	9.1	PT 3/8"	10	6	90
MI-38ESR	TOKU	1"	R+H	38	Twin-Hammer	3.700	1.850	11.7	7.75	PT 1/2"	12.7	8.7	93
MI-38ELR	TOKU	1"	R+H	38	Twin-Hammer	3.700	1.800	11.7	7.95	PT 1/2"	12.7	8.7	93
RRI-1051	RRI	1"	R+H	36	3-Jaw	4.500	3.300	24.0	9.6	PT 1/2"	19	9	92
RRI-1055	RRI	1"	H	36	Twin-Hammer	5.000	2.700	25.0	10.0	PT 1/2"	19	12	96
MI-3800ESR	TOKU	1"	R+H	36	Closed hammer	4.500	2.100	15.0	9.3	PT 1/2"	13	8	84
MI-3800ELR	TOKU	1"	R+H	36	Closed hammer	4.500	2.000	15.0	9.9	PT 1/2"	13	8	84
MI-42ESR	TOKU	1"	R+H	42	Twin-Hammer	3.900	2.850	23.0	9.4	PT 1/2"	12.7	7.6	99
MI-42ELR	TOKU	1"	R+H	42	Twin-Hammer	3.900	2.800	23.0	10.6	PT 1/2"	12.7	7.6	99
MI-4500ESR	TOKU	1"	R+H	45	Closed hammer	3.700	2.900	23.0	13.4	PT 1/2"	13	7	84
MI-4500ELR	TOKU	1"	R+H	45	Closed hammer	3.700	2.900	23.0	14.5	PT 1/2"	13	7	84
RRI-1065	RRI	1 1/2"	H	45	Twin-Hammer	3.750	4.080	40.0	14.8	PT 1/2"	19	12	97
RRI-1060	RRI	1 1/2"	H	52	3-Jaw	3.000	4.500	27.0	16.0	PT 1/2"	19	5	97

* Also available with 3/4" square drive
 # Type: H = hole type / R + H = ring + hole type

L = Long anvil

All impact wrenches have a 4-step button regulator, with exception of type RR-20PN (stepless) and YW-6CL (stepless on request).

The air consumption of the impact wrenches has been measured under working conditions.

Impact wrenches

Heavy Duty - models

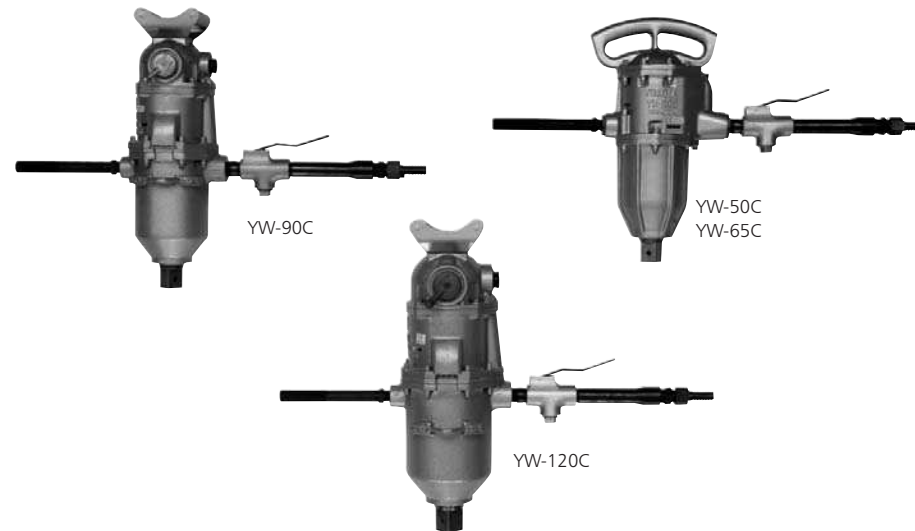

Type	Brand	Square drive	Type*	Bolt-capacity mm	Impact-mechanism	Rotations p/min	Torque Nm	Air-consumption l/sec	Weight kg	Inlet-thread	Hose-diameter mm	Vibration m/s ²	Noise level dB(A)
YW-50C	YOKOTA	1 1/2"	H	52	2-Hammer	3.000	4.500	30.0	27.0	PT 1"	19	2.3	90
YW-65C	YOKOTA	1 1/2"	H	64	2-Hammer	2.100	6.600	30.0	45.0	PT 1"	19	2.3	92
YW-90C*	YOKOTA	1 3/4"	H	90	2-Hammer	1.700	16.500	41.0	62.0	PT 1"	19	2.3	94
YW-120C	YOKOTA	2 1/2"	H	130	2-Hammer	1.800	33.000	68.0	115.0	PT 1"	19	5	93

* 1 1/2" Square drive on request / The air consumption of the impact wrenches has been measured under working conditions.
Type: H = hole type

Dimensions

Type	A mm	A* mm	B mm	C mm	D mm
MI-12	150	-	24	-	-
MI-16 3/8"	170	-	27	-	-
MI-16 1/2"	170	-	27	-	-
MI-17HE	178	-	31	-	-
MI-20P	215	-	38	-	-
MI-38ESR	337	-	50	-	-
MI-38ELR	-	515	50	-	-
MI-42ESR	370	-	60	-	-
MI-42ELR	-	517	60	-	-
MI-1600 (R)	180	-	33	-	-
MI-1600 L(R)	-	224	33	-	-
MI-2500 PR	265	-	50	-	-
MI-2500 PLR	-	383,5	50	-	-
MI-2500 ESR	341	-	50	-	-
MI-2500 ELR	-	459,5	50	-	-
MI-3800 PR	281	-	55	-	-
MI-3800 PLR	-	430	55	-	-
MI-3800 ESR	355	-	55	-	-
MI-3800 ELR	-	504	55	-	-
MI-4500 ESR	460	-	60	-	-
MI-4500 ELR	-	584	60	-	-
RR-15P	180	-	30	-	-
RR-20PN	239	-	38	-	-
RRI-17HE	180	-	31	-	-
RRI-1045	215	-	45	-	-
RRI-1051	320	-	55	-	-
RRI-1055	365	-	65	-	-
RRI-1060	400	-	78	-	-
RRI-1065	420	-	65	-	-
V-160P	182	-	34	-	-
YW-6CL	215	-	14	50	63
YW-50C	535	-	355	448	160
YW-65C	606	-	344	434	162
YW-90C	674	-	358	448	186
YW-120C	827	-	527	461	226

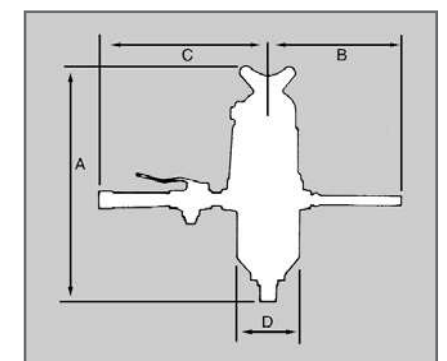
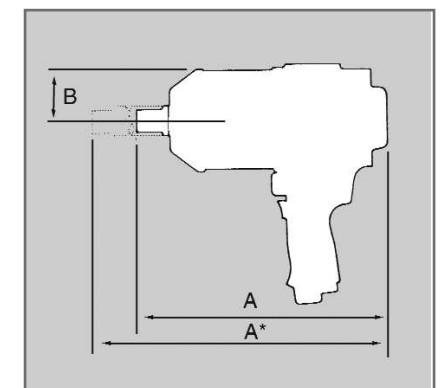
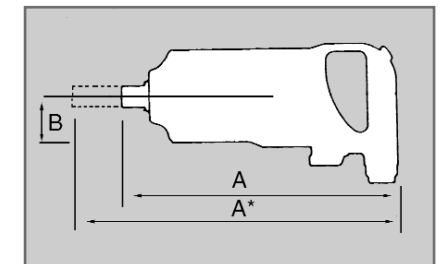
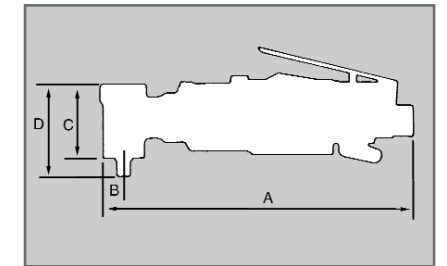

Impact sockets

Choose the right size impact socket for your impact wrench. If the sockets do not fit exactly this may cause a loss of power and wear of the anvil. For detailed information about the impact sockets we refer to the special chapter Action impact sockets. Extension bars, universal joints and adaptors are also available. Worn impact sockets cause wear on the square drive of your tools, giving more vibration to the operator.

2. Impulse wrenches

Application and impulse mechanism



Faster tools make assembly quicker

Yokota impulse wrenches are widely used for tightening jobs in the assembly industry, where accurate torque tolerances are necessary. Impulse tools are light, powerful, small and very importantly, have no kick-back. The Yokota range of impulse tools is increasing fast, starting at 6Nm to tighten small joints, and goes up to 600Nm. Evaluation of tightening processes in car assembly shows that tightening joints uses 10% of the total assembly time. Working with faster tools therefore can speed up assembly lines substantially.

A fail-safe system

Product liability is essential to carmakers. All tightened joints have to be correct. For this reason all bolted joints must be counted, documented and, of course, tightened with the right clamping force. In order to do this, you need an impulse wrench (with a built-in transducer) connected to a controller. If the controller establishes that the tightened joints do not meet the specifications, it can give a line-stop signal and the joints have to be checked manually. This fail-safe system fits perfectly in the Poka Yoke Strategy.

High repeatability

Impulse wrenches have a twin blade impulse mechanism for sealing oil which gives a high repeatability. The mechanism is designed so that the liner, rotated by the air motor gives an equal torque on both blades and instant rotation torque on the mainshaft (see figure below). A by-pass is designed in the liner so that the oil can escape from the area of high pressure to the area of low pressure at the moment of creating a pulse and the amount of oil flow can be adjusted by the relief valve to control the torque output. Depending on model and setting, the impulse wrenches give 10 - 40 impulses per second. The power is transmitted by oil pressure and therefore the impulse wrenches have a very low noise- and vibration level.

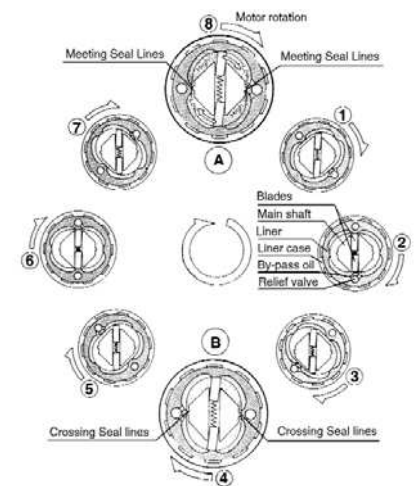

Impulse wrenches

New series Double chamber air motor, lightweight



Type	Square / Hex drive	Bolt-capacity mm	Revolutions p/min	Torque Nm*	Air-cons. l/sec	Weight kg	Inlet-thread	Hose diameter mm	Dimensions		Vibration m/s ²	Noise-level dB(A)
									A mm	B mm		
YLa70A	1/4" Hex	6-8	7.000	20-28	5.5	0.8	PT 1/4"	6.5	132	22	1.4	74
YLa80A	1/4" Hex	8	7.000	24-35	5.8	0.9	PT 1/4"	6.5	139	22	1.2	75
YLa70E	3/8" Square	6-8	7.000	20-35	5.5	0.8	PT 1/4"	6.5	132	22	1.4	74
YLa80E	3/8" Square	8	7.000	33-50	5.8	0.9	PT 1/4"	6.5	139	22	1.2	75
YLa90E	3/8" Square	8-10	6.500	47-70	6.7	1.0	PT 1/4"	9.5	148	24	1.2	78
YLa110E	1/2" Square	10-12	6.000	65-105	9.6	1.4	PT 1/4"	9.5	164	26	1.8	81
YLa120E	1/2" Square	12	6.600	80-130	10	1.8	PT 1/4"	9.5	172	28	2.2	82
YLa140E	1/2" Square	14	6.000	100-160	13	2.2	PT 1/4"	9.5	190	30	2.4	84

System impulse wrenches (see page 41)

TKa60A	1/4" Hex	6	6.000	10-16	4.5	1.3	PT 1/4"	6.5	179	22	2.1	71
TKa70A	1/4" Hex	6-8	7.000	20-27	5.3	1.3	PT 1/4"	6.5	179	22	2.1	75
TKa80A	1/4" Square	8	7.000	24-33	5.3	1.3	PT 1/4"	6.5	186	22	2.1	73
TKa60	3/8" Square	6	6.000	14-20	4.5	1.3	PT 1/4"	6.5	179	22	2.1	71
TKa70	3/8" Square	6-8	7.000	20-35	5.3	1.3	PT 1/4"	6.5	179	22	2.1	75
TKa80	3/8" Square	8	7.000	32-46	5.3	1.3	PT 1/4"	6.5	186	22	2.1	73
TKa90	3/8" Square	8-10	6.500	47-70	6.8	1.5	PT 1/4"	9.5	195	24	2.1	78
TKa110	1/2" Square	10-12	6.000	65-105	8.8	1.9	PT 1/4"	9.5	210	26	2.2	80
TKa120	1/2" Square	12	5.900	85-130	10	2.4	PT 1/4"	9.5	223	28	2.2	82
TKa140	1/2" Square	14	5.200	100-160	13	2.9	PT 1/4"	9.5	235	30	2.2	84
TKa150	1/2" Square	14-16	4.200	150-220	13	3.4	PT 1/4"	9.5	241	32	2.4	84

- No lube air motor to protect the environment
- Extended oil change intervals (new impulse mechanism design)
- Lightweight
- Low air consumption, high efficiency air motor
- High durability, due to improved air motor design features, with special patented air motor vanes
- Improved ergonomic design
- Low noise and vibration levels
- Low trigger-force

* Torque specifications

All specified torques are measured on the Yokota testers, series YET, at a dynamic airpressure of 0.63MPa. The Yokota testers have a static transducer, the specified torques are therefore to be used as a guidance only. In general the torque range will be lower in case of using lower airpressure, extension bars, torx or hexagon inset sockets, soft joints, etc.



Tailor-made tool:
YEX-150S with crowfoot



Tailor-made tool:
Y-70E with crowfoot

Accessories for impulse wrenches on pages 43 - 45.

More information on tailor-made tools on page 99. Please inform us about your specific request and we will make you a suitable proposal.

Double chamber air motor



Type	Square / Hex drive	Bolt-capacity mm	Revolutions p/min	Torque Nm*	Air-cons. l/sec	Weight kg	Inlet-thread	Hose diameter mm	Dimensions		Vibration m/s ²	Noise-level dB(A)
									A mm	B mm		
Y-40SA*	1/4" Hex	4-6	10.000	6-12	5.0	0.84	PT 1/4"	6.5	229	17	4.6	69
Y-41A	1/4" Hex	4-6	9.300	6-12	5.0	0.73	PT 1/4"	6.5	141	17	2.1	72
Y-46E	3/8" Square	5-6	8.000	16-30	5.8	0.87	PT 1/4"	9.5	158	18	1.0	80
Y-46A	1/4" Hex	5-6	8.000	16-26	5.8	0.87	PT 1/4"	9.5	158	18	1.0	80
Y-56E	3/8" Square	6-8	7.000	25-47	6.6	0.87	PT 1/4"	9.5	144	21	1.0	80
Y-56A	1/4" Hex	6-8	7.000	22-33	6.6	0.87	PT 1/4"	9.5	144	21	1.0	80
Y-61E	3/8" Square	6-8	5.500	34-54	6.6	0.96	PT 1/4"	9.5	155	21	1.0	74
Y-61A	1/4" Hex	6-8	5.500	27-41	6.6	0.96	PT 1/4"	9.5	155	21	1.0	74
Y-70	3/8" Square	8-10	5.500	44-72	7.5	1.4	PT 1/4"	9.5	170	25	2.0	75
Y-90E	1/2" Square	10-12	5.000	78-116	8.3	1.85	PT 1/4"	9.5	177	30	1.5	72
Y-100E	1/2" Square	12	5.000	100-145	11.8	2.0	PT 1/4"	12.7	188	32.5	2.1	80
Y-130E	1/2" Square	14	3.500	140-220	12.8	2.5	PT 1/4"	12.7	201	34	2.2	83
Y-140	3/4" Square	16	3.300	160-270	13.1	3.2	PT 1/4"	12.7	226	36	3.3	82

* The Y-40SA is a straight model, all other types are pistol models.

** Torque specifications

All specified torques are measured on the Yokota testers, series YET, at a dynamic airpressure of 0.63MPa. The Yokota testers have a static transducer, the specified torques are therefore to be used as a guidance only. In general the torque range will be lower in case of using lower airpressure, extension bars, torx or hexagon inset sockets, soft joints, etc.

For information about sleeve drive sockets please see page 43.



Y-40SA

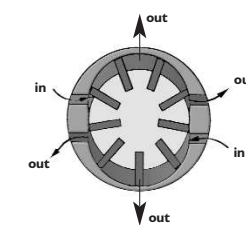

The Yokota Y-, YLa-, YED- and TKa-series impulse wrenches with double chamber air motor reach the required torque very quickly. The tools have a high number of impulses per second, and therefore very accurate torques can be realized, resulting in increased production speed.

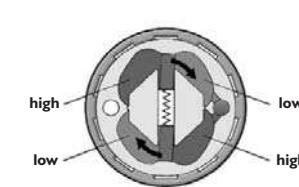

Patented twin blade impulse unit. Yokota's unique impulse mechanism reduces noise and vibration! High impulse frequency.

Impulse wrenches

Double chamber air motor & shut-off

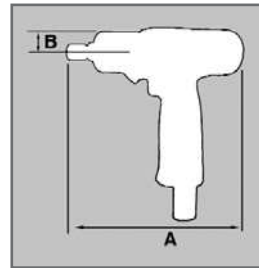

Type	Square / Hex drive	Bolt capacity mm	Rotations p/min	Torque Nm*	Air-cons. l/sec	Weight kg	Inlet-thread	Hose diameter mm	Dimensions		Vibration m/s ²	Noise level dB(A)
									A mm	B mm		
Y-T40A	1/4" Hex	4-5	6.000	8-13	6.0	0.95	PT 1/4"	6.5	182	18.5	2.2	82
Y-T45E	3/8" Square	6	7.000	17-25	5.8	1.10	PT 1/4"	9.5	187	21	1.6	74
Y-T45A	1/4" Hex	6	7.000	15-20	5.8	1.10	PT 1/4"	9.5	187	21	1.6	74
Y-T55E	3/8" Square	6-8	6.000	25-38	5.8	1.12	PT 1/4"	9.5	187	21	2.3	75
Y-T55A	1/4" Hex	6-8	6.000	20-30	5.8	1.12	PT 1/4"	9.5	187	21	2.3	75
Y-T70E	3/8" Square	10	5.500	40-55	6.6	1.50	PT 1/4"	9.5	207	25	2.1	82
Y-T90E	1/2" Square	10-12	5.000	60-90	7.5	1.90	PT 1/4"	9.5	200	31	1.5	85

* Torque specifications

All specified torques are measured on the Yokota testers, series YET, at a dynamic airpressure of 0.63MPa. The Yokota testers have a static transducer, the specified torques are therefore to be used as a guidance only. In general the torque range will be lower in case of using lower airpressure, extension bars, torx or hexagon inset sockets, soft joints, etc.

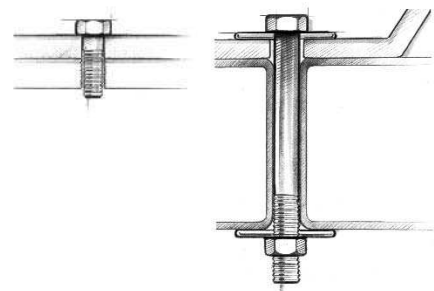

In order to get full benefit of all the advantage of impulse wrenches, it is most important that the correct tool is used for the correct application. Each joint has its own characteristics. Please ask us to help you to select the right tool for your application.

Accessories for impulse wrenches on pages 43 - 45.

Rubber protection covers for all Y and Y-T impulse wrenches are included in the box.

Battery impulse wrenches



Type	Square / Hex drive	Bolt capacity mm	Rotations p/min	Torque Nm*	Weight kg	Dimensions		Vibration m/s ²	Noise level dB(A)
						A mm	B mm		
YBX-50A	1/4" Hex	5-8	2.200	7-22	1.7	194	26	3	79
YBX-50E	3/8" Square	5-8	2.200	7-22	1.7	194	26	3	79

Type	Square / Hex drive	Bolt capacity mm	Rotations p/min	Torque Nm*	Weight kg	Dimensions		Vibration m/s ²	Noise level dB(A)
						A mm	B mm		
YBX-600T	3/8" Square	M6	2.000	20-30	1.5	170	-	-	-
YBX-800T	3/8" Square	M8	2.000	26-36	1.5	174	-	-	-

* Torque specifications

All specified torques are measured on the Yokota testers, series YET, at a dynamic airpressure of 0.63MPa. The Yokota testers have a static transducer, the specified torques are therefore to be used as a guidance only. In general the torque range will be lower in case of using lower airpressure, extension bars, torx or hexagon inset sockets, soft joints, etc.

YBX-600T and YBX-800T are very precise. ETC.

Battery: standard or with LED-indication. Chargers for 20 or 105 minutes can be supplied (see page 44). Multiple charger on request.

Accessories for impulse wrenches on pages 43 - 45.



YBX-50A - left/right switch



Better ergonomics and grip



Yokota impulse technology



YBX-50A - easy service

Poka Yoke⁺ system

Critical tightening



Type	Square / Hex drive	Bolt capacity mm	Rotations p/min	Torque Nm*	Air-cons. l/sec	Weight kg	Inlet-thread	Hose diameter mm	Dimensions A mm	B mm	Vibration m/s ²	Noise level dB(A)
Y-41A-JQ	1/4" Hex	4-6	9.300	6-12	5.0	0.73	PT 1/4"	6.5	141	17	2.1	72
Y-46E-JQ	3/8" Square	5-6	8.000	16-30	5.8	0.87	PT 1/4"	9.5	158	18	1.0	80
Y-56E-JQ	3/8" Square	6-8	7.000	25-47	6.6	0.87	PT 1/4"	9.5	144	21	1.0	80
Y-61E-JQ	3/8" Square	6-8	5.500	34-54	6.6	0.96	PT 1/4"	9.5	155	21	1.0	74
Y-70-JQ	3/8" Square	8-10	5.500	44-72	7.5	1.4	PT 1/4"	9.5	170	25	2.0	75
Y-90E-JQ	1/2" Square	10-12	5.000	78-116	8.3	1.85	PT 1/4"	9.5	177	30	1.5	72
Y-100E-JQ	1/2" Square	12	5.000	100-145	11.8	2.0	PT 1/4"	12.7	188	32.5	2.1	80
Y-130E-JQ	1/2" Square	14	3.500	140-220	12.8	2.5	PT 1/4"	12.7	201	34	2.2	83
Y-140-JQ	3/4" Square	16	3.300	160-270	13.1	3.2	PT 1/4"	12.7	226	36	3.3	82

New lightweight series

YLa 70 A-JQ	1/4" Hex	6-8	7.000	20-28	5.5	0.80	PT 1/4"	6.9	132	22	1.4	74
YLa 70 E-JQ	3/8" Square	6-8	7.000	20-35	5.5	0.80	PT 1/4"	6.5	132	22	1.4	74
YLa 80 A-JQ	1/4" Hex	8	7.000	24-35	5.8	0.90	PT 1/4"	6.5	139	22	1.2	75
YLa 80 E-JQ	3/8" Square	8	7.000	33-50	5.8	0.90	PT 1/4"	6.5	139	22	1.2	75
YLa 90 E-JQ	3/8" Square	8-10	6.500	47-70	6.7	1.00	PT 1/4"	9.5	148	24	1.2	78
YLa 110 E-JQ	1/2" Square	10-12	6.000	65-105	9.6	1.40	PT 1/4"	9.5	164	26	1.8	81
YLa 120 E-JQ	1/2" Square	12	6.600	80-130	10	1.8	PT 1/4"	9.5	172	28	2.2	82
YLa 140 E-JQ	1/2" Square	14	6.000	100-160	13	2.2	PT 1/4"	9.5	190	30	2.4	84

* Torque specifications

All specified torques are measured on the Yokota testers, series YET, at a dynamic airpressure of 0.63MPa. The Yokota testers have a static transducer, the specified torques are therefore to be used as a guidance only. In general the torque range will be lower in case of using lower airpressure, extension bars, torx or hexagon inset sockets, soft joints, etc.

System features

- Group control
- Controlled shut-off
- Double tightening detection
- Interlock with assembly line
- Error judgement on trigger release
- Teach-in mode for programming
- Oil deterioration indication

Controller YTC-3

- Power supply: 100 - 240V AC
- Input: 8
- Relay output: 4
(opening and shutting capacity: Max. DC-48W, AC-220VA)
- Output for solenoid valve: 1
(DC24V 2W)

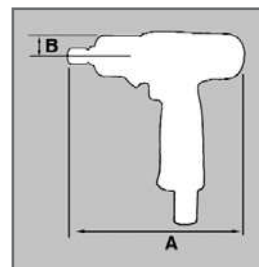

Poka Yoke⁺: function principle

The system is controlled by measuring the air pressure at the inlet side of the air motor. This air pressure varies from free running to impulsing. By this measured air pressure the controller detects contact of the bolt head (point 2). Upon contact, the adjustable timer gives the shut-off signal (point 3). Adjustability of the timer takes care of adoption to either hard or soft joints. Similar, the controller detects double hits and trigger release before shut-off.

Superior clampforces

In conventional shut-off tools point 2 is the shut-off point. Due to the above mentioned principle of the Poka Yoke⁺ controller, the relaxation is minimized and the correct torque and clamp-force are achieved. The torque is adjusted at the impulse mechanism. In combination with the parameters in the controller YTC-3, a reliable shut-off is achieved.

The whole system is more accurate than shut-off or standard impulse wrenches.

Typical air pressure curve of the impulse wrench

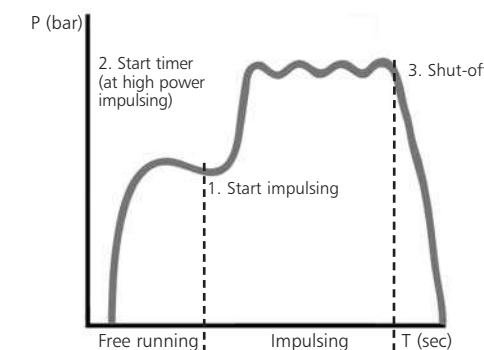

Impulse wrenches

Pistol models



Type	Square / Hex drive	Bolt capacity mm	Rotations p/min	Torque Nm*	Air-cons. l/sec	Weight kg	Inlet-thread	Hose diameter mm	Dimensions A mm B mm	Vibration m/s ²	Noise level dB(A)
------	--------------------	------------------	-----------------	------------	-----------------	-----------	--------------	------------------	----------------------	----------------------------	-------------------

Pistol models

YX-180E	3/8" Square	4-6	10.500	19-31	4.2	1.0	PT 1/4"	6	169 23	3	72
YX-180A	1/4" Hex	4-6	10.500	18-30	4.2	1.0	PT 1/4"	6	169 23	3	72
YX-280E	3/8" Square	6-8	10.500	25-38	5.0	1.02	PT 1/4"	6	180 23	2	70
YX-280A	1/4" Hex	6-8	10.500	20-34	5.0	1.02	PT 1/4"	6	180 20	2	70
YX-380E	3/8" Square	8	10.000	34-47	5.0	1.24	PT 1/4"	6	180 25	2.1	75
YX-380A	1/4" Hex	6-8	10.000	29-44	5.0	1.24	PT 1/4"	6	180 25.5	2.1	75
YX-500E	3/8" Square	8-10	8.200	31-55	5.8	1.4	PT 1/4"	6	173 26.5	2	68
YX-700E	3/8" Square	8-10	8.000	45-78	6.7	1.6	PT 1/4"	9	185 26.5	2	68
YX-900E	1/2" Square	10	6.500	70-111	6.7	2.0	PT 1/4"	9	201 30.5	2	72
YX-1100E	1/2" Square	10-12	4.700	85-123	7.5	2.2	PT 1/4"	9	210 30.5	2.5	72
YX-1400E	1/2" Square	12-14	6.000	102-148	8.3	2.7	PT 1/4"	9	214 33.5	2.6	78
YX-1900E	1/2" Square	12-14	5.800	140-201	8.3	3.4	PT 1/4"	9	224 35.5	3	79
YX-2400E	1/2" Square	14-16	4.200	175-279	9.2	4.1	PT 1/4"	9	236 37.0	5.3	77
YX-3000	3/4" Square	16-18	4.700	200-304	10.0	4.6	PT 1/4"	12.7	246 40.0	3.9	80
YX-4500	3/4" Square	18-20	3.400	392-490	11.6	9.8	PT 3/8"	12.7	300 65.0	3.9	87

* Torque specifications

All specified torques are measured on the Yokota testers, series YET, at a dynamic airpressure of 0.63MPa. The Yokota testers have a static transducer, the specified torques are therefore to be used as a guidance only. In general the torque range will be lower in case of using lower airpressure, extension bars, torx or hexagon inset sockets, soft joints, etc.

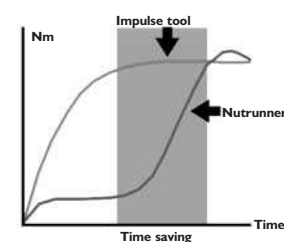

Save time - save money

Because of the principal of using hydraulics to reach a certain torque, impulse tools can run at a high rpm. The required torque is reached in a split second. All Yokota impulse wrenches can be used for hard and soft joints, and give a high accuracy / repeatability and a low relaxation.

Straight / Angle models



Type	Square / Hex drive	Bolt capacity mm	Rotations p/min	Torque Nm*	Air-cons. l/sec	Weight kg	Inlet-thread	Hose diameter mm	Dimensions A mm B mm	Vibration m/s ²	Noise level dB(A)
------	--------------------	------------------	-----------------	------------	-----------------	-----------	--------------	------------------	----------------------	----------------------------	-------------------

Straight models

YX-180SE	3/8" Square	4-6	10.500	19-31	4.2	0.96	PT 1/4"	6	220 23	3.3	73
YX-180SA	1/4" Hex	4-6	10.500	18-30	4.2	0.96	PT 1/4"	6	220 23	3.3	73
YX-280SE	3/8" Square	6-8	10.500	25-38	5.0	1.02	PT 1/4"	6	232 23	4	73
YX-280SA	1/4" Hex	6	10.500	20-34	5.0	1.02	PT 1/4"	6	232 23	4	73
YX-380SE	3/8" Square	8	10.000	32-47	5.0	1.18	PT 1/4"	6	232 25.5	3.3	75
YX-380SA	1/4" Hex	6-8	10.000	29-44	5.0	1.18	PT 1/4"	6	232 25.5	3.3	75
YX-500SE	3/8" Square	8-10	7.500	31-55	5.0	1.25	PT 1/4"	6	241 25.5	6.6	74
YX-700SE	3/8" Square	8-10	5.000	35-62	5.8	1.5	PT 1/4"	9	262 26.5	6.6	72

Angle models

YX-280C	3/8" Square	4-6	10.000	15-24	5.0	1.4	PT 1/4"	6	257 16.0	4	83
YX-500C	3/8" Square	6-8	7.500	30-45	5.0	1.5	PT 1/4"	6	266 18.0	10	73
YX-700C	3/8" Square	8-10	5.000	36-50	5.8	1.8	PT 1/4"	9	289 18.0	8.6	72

* Torque specifications

All specified torques are measured on the Yokota testers, series YET, at a dynamic airpressure of 0.63MPa. The Yokota testers have a static transducer, the specified torques are therefore to be used as a guidance only. In general the torque range will be lower in case of using lower airpressure, extension bars, torx or hexagon inset sockets, soft joints, etc.

For all impulse wrenches quick change couplings - 7/16" hex are available. You can choose out of 2 sizes:
 * DO9938-0-100 for 3/8" square drive
 * DO9912-0-100 for 1/2" square drive

Accessories for impulse wrenches on pages 43 - 45.

Impulse wrenches

Shut-off



Type	Square / Hex drive	Bolt capacity mm	Rotations p/min	Torque Nm*	Air-cons. l/sec	Weight kg	Inlet-thread	Hose diameter mm	Dimensions		Vibration m/s ²	Noise level dB(A)
									A mm	B mm		
YXS-500E	3/8" Square	8-10	8.200	30-50	6.0	1.74	PT 1/4"	6	199	35	2	68
YXS-700E	3/8" Square	8-10	8.000	45-70	6.6	1.94	PT 1/4"	9	211	36	1.6	68
YXS-900E	1/2" Square	10	6.500	65-101	6.6	2.45	PT 1/4"	9	227	40	2	72
YXS-1100E	1/2" Square	10-12	4.700	80-110	7.5	2.5	PT 1/4"	9	237	40	3	76
YXS-1900E	1/2" Square	12-14	5.800	100-160	8.3	3.9	PT 1/4"	9	259	46.5	2.4	79

Note: All YXS impulse wrenches are pistol models.

* Torque specifications

All specified torques are measured on the Yokota testers, series YET, at a dynamic airpressure of 0.63MPa. The Yokota testers have a static transducer, the specified torques are therefore to be used as a guidance only. In general the torque range will be lower in case of using lower airpressure, extension bars, torx or hexagon inset sockets, soft joints, etc.

Accessories for impulse wrenches on pages 43 - 45.

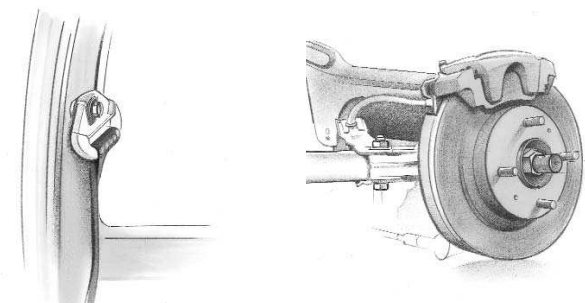

Bolt/torque control

Electronic control for YEX-, YED- and TKa series

Multi Fastening Controller YETC-200 / YETC-300

The YETC-200/300 are developed for accurate tightening and fit in a Poka Yoka assembly process. The controllers measure, judge, count and document all joints and if necessary, file them in a computer. Communication between the controller and the computer increases the number of facilities. One controller can operate four different impulse wrenches with different specifications (like torque adjustments). By programming different groups for each group of joints, the operator can switch tools without notifying the controller. The controller automatically switches to operate the next tool, after tightening all joints within the group according to the specifications. The controller is available in several executions for all kinds of applications and can be programmed in numerous ways, in relation to the various joints.



YETC-200

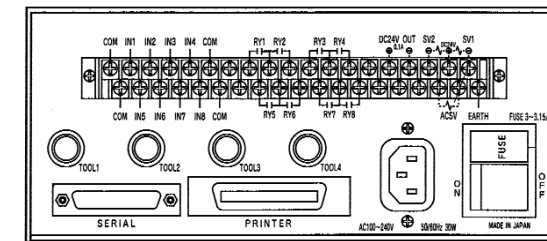

YETC-200



YETC-300



YETC-300

Features YETC-200 ETB

- Easy to program, according application specifications
- Improved electronics for even more accurate and fastertorque calculations
- Torque calculation over more impulses
- Standard 1 tool connection
- Optional 4 tool connection (not to operate at the same time)
- Compensation impulses to minimize relaxation
- Poka Yoke proof (group control, etc.)
- 2-step tightening possible
- Buzzer or LED version tool
- 8 setting groups-
- Parallel and RS-232 output for traceability
- External solenoid valves in air supply
- Integration in the production possible by means of many input- / output signals

Extra features YETC-200 EA

- 2-way communication by RS-232
- Automatic group change (sequence programmable)
- Real time clock
- Built in timer (for job)
- More input signals (see manual for details)
- More output signals (see manual for details)
- Can be integrated in the production any thinkable way (input - output signals)
- Statistics inside CPK
- Memory for 10.000 cycles

Extra features YETC-200 EA-LAN

- Ethernet (100 BASE-TX/10 BASE-T Autodetect function)
- Protocol: TCP/IP
- Connector: RJ-45

Features YETC-300

- Same functionality and parameters as in YETC-200
- Two tools can be used simultaneously

System wrenches

Documentation of the joint

Yokota has impulse wrenches with an integrated transducer (system wrenches). In combination with a controller YETC-200 / YETC-300 the torque can be set and judged. The measured torque can be stored in a computer or printed. With this system can be shown that the correct joint was made, in case of product liability claims. The system wrenches only need 1 to 2 seconds for each joint. The tools have no kick back and fit perfectly in a Poka Yoke assembly area.

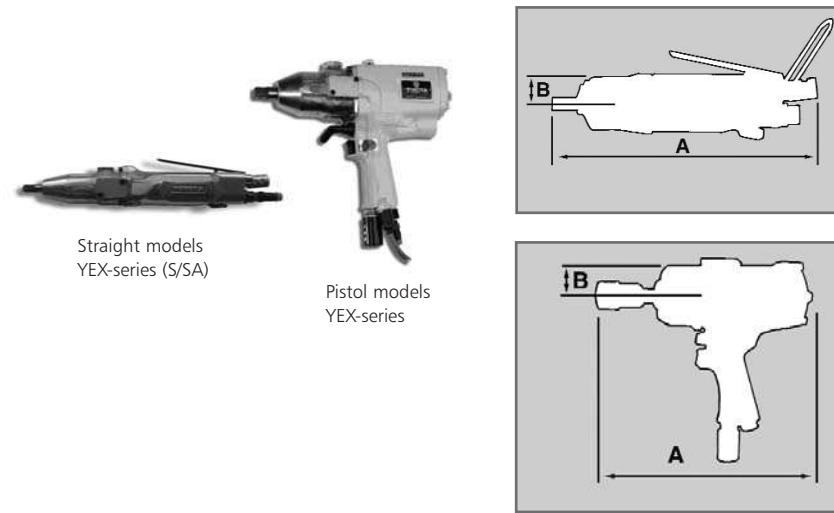

Type	Square / Hex drive	Bolt capacity mm	Rotations p/min	Torque Nm*	Air-cons. l/sec	Weight kg	Inlet-thread	Hose diameter mm	Dimensions		Vibration m/s ²	Noise level dB(A)
									A mm	B mm		
YEX-100SA	3/8" Hex	5	8.000	4.3 - 12	3.6	1.2	PT 1/4"	9.5	285	23	3	77
YEX-120	3/8" Square	4-5	9.000	13-17	4.2	1.43	PT 1/4"	9.5	222	23	3	72
YEX-120A	1/4" Hex	4-5	9.000	11-15	4.2	1.43	PT 1/4"	9.5	223	23	3	72
YEX-150	3/8" Square	5-6	9.000	19-27	4.2	1.43	PT 1/4"	9.5	222	23	3	72
YEX-150A	1/4" Hex	5-6	9.000	14-22	4.2	1.43	PT 1/4"	9.5	223	23	3	72
YEX-150S	3/8" Square	5-6	8.000	19-27	4.2	1.35	PT 1/4"	9.5	275	23	3.3	73
YEX-150SA	1/4" Hex	5-6	8.000	14-22	4.2	1.35	PT 1/4"	9.5	276	23	3.3	73
YEX-300S	3/8" Square	6	8.000	25-33	5.0	1.8	PT 1/4"	9.5	312	27	5.3	71
YEX-300SA	1/4" Hex	6	8.000	21-29	5.0	1.8	PT 1/4"	9.5	313	27	5.3	71
YEX-501	3/8" Square	6-8	8.200	25-52	5.3	2.0	PT 1/4"	9.5	234	26.5	1.6	68
YEX-501A	1/4" Hex	6-8	8.200	23-49	5.3	2.0	PT 1/4"	9.5	227	26.5	1.6	68
YEX-500S	3/8" Square	6-8	7.800	23-49	5.0	2.1	PT 1/4"	9.5	333	27	6.6	71
YEX-500SA	1/4" Hex	6-8	7.800	21-47	5.0	2.1	PT 1/4"	9.5	224	27	6.6	71
YEX-700S	3/8" Square	8	7.500	33-61	5.8	2.3	PT 1/4"	9.5	333	27	6.6	72
YEX-701	3/8" Square	8-10	8.000	45-75	6.7	2.2	PT 1/4"	9.5	246	26.5	1.6	71
YEX-901	1/2" Square	10	6.100	61-104	6.7	2.7	PT 1/4"	9.5	257	33.5	2.3	73
YEX-1400	1/2" Square	10-12	5.900	92-142	8.3	3.5	PT 1/4"	9.5	266	34	3	80
YEX-1900	1/2" Square	12	5.800	115-183	8.3	4.1	PT 1/4"	9.5	277	39	3	80
YEX-3000	3/4" Square	16	4.000	186-284	10.0	6.4	PT 1/4"	12.7	309	40	4	82

Note: All YEX-types are pistol models, with exception of the S and SA types.

* Torque specifications

All specified torques are measured on the Yokota testers, series YET, at a dynamic airpressure of 0.63MPa. The Yokota testers have a static transducer, the specified torques are therefore to be used as a guidance only. In general the torque range will be lower in case of using lower airpressure, extension bars, torx or hexagon inset sockets, soft joints, etc.

Special hose (type YP YEX) for protection of the signal cable minimizes production stops due to cable damage. Applicable on all YEX pistol models. Standard length: 7m (page 44).

Rubber protection covers for system wrenches are included in the box, with exception of the straight models (page 44).

Accessories for impulse wrenches on pages 43 - 45.

Double chamber air motor

The YED system wrenches are equal to the YEX-series, but with the added feature of a double chamber air motor. The system wrenches with double chamber air motor reach the required torque very quickly. The tools have a high number of impulses per second, and therefore very accurate torques can be realized. On top of that, Tka series have lighter weight, can run on oilfree air and offer best ergonomics. Tka-series can be delivered optionally with LED signalling instead of a buzzer.

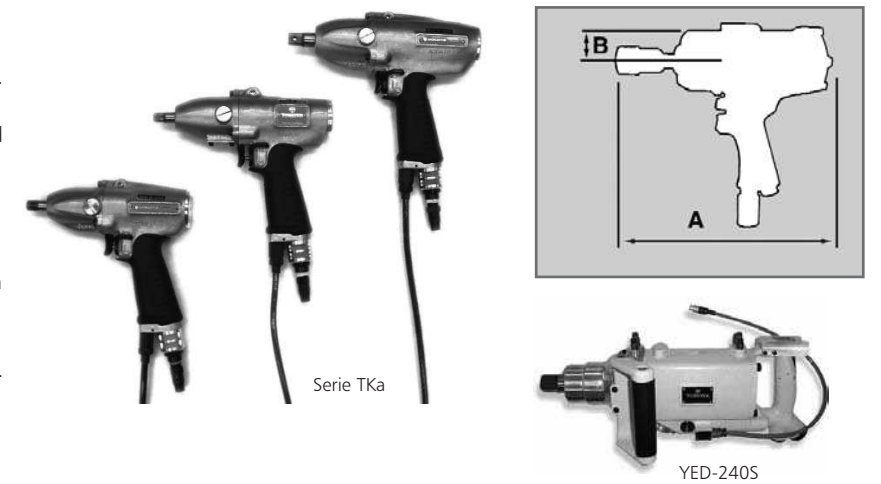

New lightweight series

Type	Square / Hex drive	Bolt capacity mm	Rotations p/min	Torque Nm*	Air-cons. l/sec	Weight kg	Inlet-thread	Hose diameter mm	Dimensions		Vibration m/s ²	Noise level dB(A)
									A mm	B mm		
TKa60A	1/4" Hex	6	6.000	11-16	4.5	1.3	PT 1/4"	6.5	179	22	2.1	71
TKa70A	1/4" Hex	6-8	7.000	20-27	5.3	1.3	PT 1/4"	6.5	179	22	2.1	75
TKa80A	1/4" Hex	8	7.000	24-33	5.3	1.3	PT 1/4"	6.5	186	22	2.1	73
TKa60	3/8" Square	6	6.000	14-20	4.5	1.3	PT 1/4"	6.5	179	22	2.1	71
TKa70	3/8" Square	6-8	7.000	20-35	5.3	1.3	PT 1/4"	6.5	179	22	2.1	75
TKa80	3/8" Square	8	7.000	32-46	5.3	1.3	PT 1/4"	6.5	186	22	2.1	73
TKa90	3/8" Square	8-10	6.500	47-70	6.8	1.5	PT 1/4"	9.5	195	24	2.1	78
TKa110	1/2" Square	10-12	6.000	65-105	8.8	1.9	PT 1/4"	9.5	210	26	2.2	80
TKa120	1/2" Square	12	5.900	85-130	10	2.4	PT 1/4"	9.5	223	28	2.2	82
TKa140	1/2" Square	14	5.200	100-160	13	2.9	PT 1/4"	9.5	235	30	2.2	84
TKa150	1/2" Square	14-16	4.200	150-220	13.2	3.4	PT 1/4"	9.5	242	32	2.4	84
YED-200	3/4" Square	20	3.400	155-360	18.3	6.8	PT 1/2"	12.7	309	40	4.2	86
YED-240S*	1" Square	24	3.000	250-600	28.3	11.2	PT 1/2"	12.7	452	52.5	15	92

* YED-240S is a straight model. ** See torque specifications on page 40.



Optional on Tka System Wrenches: integrated LED status-signal:

- Green = OK
- Red = not OK

Visible from every angle: left, right, from top and behind.

For a system YEX, YED or Tka you need:

- 1x Controller YETC-200 GTB or YETC-200 EA
- 1x Impulse wrench YEX, YED or Tka
- 1x Solenoid valve and tool cable (7m) YETC-2 SVC

Optional equipment:

- For two-step tightening YETC-2ETB SVD (2 solenoid valves, 2 air pressure regulators and a tool cable 7m)
- Printer YETC-3P and cable YETC-2PC
- Tool cables: YP7642-0908-01-38, connecting cable, YP7642-1400-00-00 (10m), YP7642-0908-01-19 (15m)
- Lamp tower
- Socket selector box
- Spiral hose with integrated toolcable, max. 15m (-misc010606).



The transducer for the YEX, YED and Tka

The strain gauges are positioned on the main shaft, picking up the twisting torque on the main shaft at each impulse as close as possible to the socket. The electric signals are transmitted by induction through the internal- and external coils. Due to this principle the Yokota transducer is very reliable, accurate and without wear.

System wrench

Yokota E-wrench



The Yokota E-wrench has been developed on request of the car industry in order to decrease the cost of production. This has been achieved by decreasing the energy consumption. The energy consumption of the E-wrench is only 10% of an comparable air tool. This benefits the environment as well.

Features

- Better ergonomics due to lower noise- and vibrationlevels, low trigger force and no reaction force
- The E-wrench has a high performance, which results in the same torque accuracy as the YEX/YED/TKa (air) system wrench
- High degree of reliability and safety

In comparison with continuous drive tools:

- Time savings up to 35% possible
- At the same torque level: higher clamp-forces and less relaxation



Type	Square-drive	Bolt capacity mm	Rotations p/min	Torque Nm*	Spindle-offset mm	Weight kg	Noise level under load dB(A)
e-M60	3/8"	6	3.500	10 - 25	23	1.9	73
e-M80	3/8"	8	3.500	20 - 40	23	2.6	73

* Torque specifications

All specified torques are measured on the Yokota testers, series YET. The Yokota testers have a static transducer, the specified torques are therefore to be used as a guidance only. In general the torque range will be lower in case of using lower airpressure, extension bars, torx or hexagon inset sockets, soft joints, etc.

System configuration

Using AC 100 - 240V as power source. Tightening with torque control function. Torque controller is common with YEX-system air operated wrenches. Driver unit is required to drive the motor. Controller (YETC-200/300) and driver unit (e-PDA-2) to be ordered separately.



Accessories

Sleeve drive impact sockets

Sleeve drive impact sockets are developed by Action on demand of Yokota, to improve the quality of tightenings with impulse wrenches. Sleeve drive impact sockets have less play between socket and anvil, thus reducing wobble and increasing the torque repeatability.



Less Vibration, less noise, less wear and better torque tolerance!

Sleeve drive impact sockets

An overview of our program:

- Hexagon sockets
- Normal or long execution
- Torx ®, internally and externally
- Magnetic executions
- Sockets for internal hexagon boltheads
- 3/8", 1/2" and 3/4" square drive
- Adapters and extensions

Ask for our special brochure on sleeve drive impact sockets.



Quickchange adapters

Accessories

For (system)impulse wrenches

Rubber protection cover



Order number	For type
0089-0029-00-00	YX-180
0081-0029-00-00	YX-280
0086-0029-00-00	YX-380
0077-0029-00-01	YX-500
0129-0029-00-01	YX-700
0237-0029-00-01	YX-900
0241-0029-00-00	YX-1100
0322-0029-00-00	YX-1400
0320-0029-00-00	YX-1900
0406-0029-00-00	YX-2400
0405-0029-00-00	YX-3000
0186-0029-00-00	TKa60
0186-0029-00-00	TKa70
0193-0029-00-00	TKa80
0181-0029-00-00	TKa90
0187-0029-00-00	TKa110
0342-0029-00-00	TKa120
0341-0029-00-00	TKa140
0343-0029-00-00	TKa150
0189-0029-00-00	YLa70
0191-0029-00-00	YLa80
0188-0029-00-00	YLa90
0190-0029-00-00	YLa110
0161-0029-00-00	Y-41
0160-0029-00-00	Y-46
0159-0029-00-00	Y-56
0158-0029-00-00	Y-61
0135-0029-00-00	Y-70
0141-0029-00-00	Y-90
0334-0029-00-00	Y-100
0335-0029-00-00	Y-130
0412-0029-00-00	Y-140
0164-0029-00-00	Y-T45
0164-0029-00-00	Y-T55
0166-0029-00-00	Y-T70
0167-0029-00-00	Y-T90
0409-0029-00-00	YED-200
0093-0029-00-00	YEX-120
0093-0029-00-00	YEX-150
0260-0029-00-00	YEX-501
0143-0029-00-00	YEX-701
0261-0029-00-00	YEX-901
0323-0029-00-00	YEX-1400
0321-0029-00-00	YEX-1900
0407-0029-00-00	YEX-3000

Battery for battery impulse wrenches



Order number	For type	Description
8530-3001-00-01	YBX-1/YBX-50	9,6 Volt / 2.0 AH, type EB-9B, Ni-Cad
8530-3002-00-00	YBX-1/YBX-50	9,6 Volt / 2.0 AH, type EB-9M, Ni-Cad with LED-indication
8530-3005-00-01	YBX-50	9.6 Volt / 3.0 AH, type EB-930H, Ni-Mn

Chargers for battery impulse wrenches



Order number	For type	Description
8530-4005-00-00	YBX-1/YBX-50	230 Volt, type UC24YC Charging time 20 minutes

Quickchange couplers 7/16" Hex



Order number	For type
D09938-0-100	3/8" Square drive
D09912-0-100	1/2" Square drive

Protection hose



Order number	For type
YP YEX	YEX and YED series

Spiral hose



Order number	For type
MISC010606	For all system wrenches

Tool holder



Order number	For type
SKK	YX-180 / YX-500 / YXS-500 / Y-40 / Y-61 / Y-T45 / Y-T55 / YEF-45 / YEF-55 / YEX-120 / YEX-150 / YED-60
SKZ	YX-500S / YX-1400 / YXS-700 / YXS-1100 / Y-70 / Y-90 / Y-130 / Y-T70 / Y-T90 / YEF-70 / YEF-90 / YEX-300 / YEX-1400 / YBX-50

Accessories

For maintenance and service

Service sets

You will need these service sets with spare parts if you are going to change the oil. For quick service we advise you to use a vacuum pump and oil tank (YEVP-1 + YEVP-1T).

Please note!

Always use oil with the right specifications when changing oil. Only then you will have an optimal tool power and a minimum oil consumption. We recommend NOBP oil for the impulse unit.

For type	Order number
YX-80	0095-0991-00-99
YX-180	0089-0991-01-99
YX-280	0089-0991-01-99
YX-380	0086-0991-01-99
YX-500S (C)	0086-0991-01-99
YX-500	0077-0991-02-99
YX-700 (S)	0129-0991-00-99
YX-700C	0281-0991-01-99
YX-900	0237-0991-01-99
YX-1100	0237-0991-01-99
YX-1400	0322-0991-00-99
YX-1900	0320-0991-00-99
YX-2400	0320-0991-00-99
YX-3000	0405-0991-00-99
YX-4500	0722-0991-00-99
YXS-500	0245-0991-00-99
YXS-700	0246-0991-00-99
YXS-900	0243-0991-01-99
YXS-1100	0243-0991-01-99
YXS-1900	0248-0991-00-99

TKa-60	0186-0991-00-99
TKa-70	0186-0991-00-99
TKa-80	0193-0991-00-99
TKa-90	0181-0991-00-99
TKa-110	0187-0991-00-99
TKa-120	0342-0991-00-99
TKa-140	0341-0991-00-99
TKa-150	0304-0991-00-99

Yokota torque measuring equipment (YET-series) is specially designed to check and test the functioning and performance of impulse wrenches. All specified torque figures in this brochure are measured on a Yokota torque tester (YET series), with 0.63 MPa air pressure (dynamic). This is a static torque tester. Torque values may differ with other measuring equipment and/or joints (hard/soft).

Model YET-501C	5 - 50 Nm
Model YET-2001C	20 - 200 Nm
Model YET-5001C	100 - 500 Nm



Service sets containing: O-rings, back-up rings and springs for impulse mechanisms required for oil change.

For type	Order number
YLa-70	0189-0991-00-99
YLa-80	0191-0991-00-99
YLa-90	0188-0991-00-99
YLa-110	0190-0991-00-99
Y-41	0095-0991-00-99
Y-46	0273-0991-01-99
Y-56	0259-0991-01-99
Y-61	0259-0991-01-99
Y-70	0135-0991-03-99
Y-90	0141-0991-00-99
Y-100	0334-0991-01-99
Y-130	0335-0991-00-99
Y-140	0412-0991-02-09
YBX-1	0259-0991-01-99
YBX-50	0259-0991-01-99
YED-200	0409-0991-00-99
YED-240S	0411-0991-01-99
YEX-120	0089-0991-01-99
YEX-150	0089-0991-01-99
YEX-300S	0086-0991-01-99
YEX-500S	0077-0991-02-99
YEX-501	0077-0991-02-99
YEX-700S	0143-0991-00-99
YEX-701	0143-0991-00-99
YEX-901	0237-0991-01-99
YEX-1400	0323-0991-00-99
YEX-1900	0320-0991-00-99
YEX-3000	0405-0991-00-99
Y-T40	0169-0991-00-99
Y-T45	0164-0991-02-99
Y-T55	0164-0991-02-99
Y-T70	0166-0991-00-99
Y-T90	0167-0991-01-99



3. Ratchet wrenches

Applications



Toku

Toku ratchet wrenches are used for industrial workshop applications.

Red Rooster

Red Rooster Automotive (RRA) ratchet wrenches are used for light workshop applications.

Yokota

Yokota ratchet wrenches are used where accurate torque is required while the accessibility is limited. By turning the wrench 180 degrees the connection can be loosened as well.

Impact sockets

Choose the right size impact socket for your ratchet wrench. If the sockets do not fit exactly this may cause a loss of power and wear of the anvil. For detailed information about the impact sockets we refer to the chapter with Action impact sockets. Extension bars, universal joints and adaptors are also available.

Ratchet wrenches

1/4" + 3/8" + 1/2" Square drive

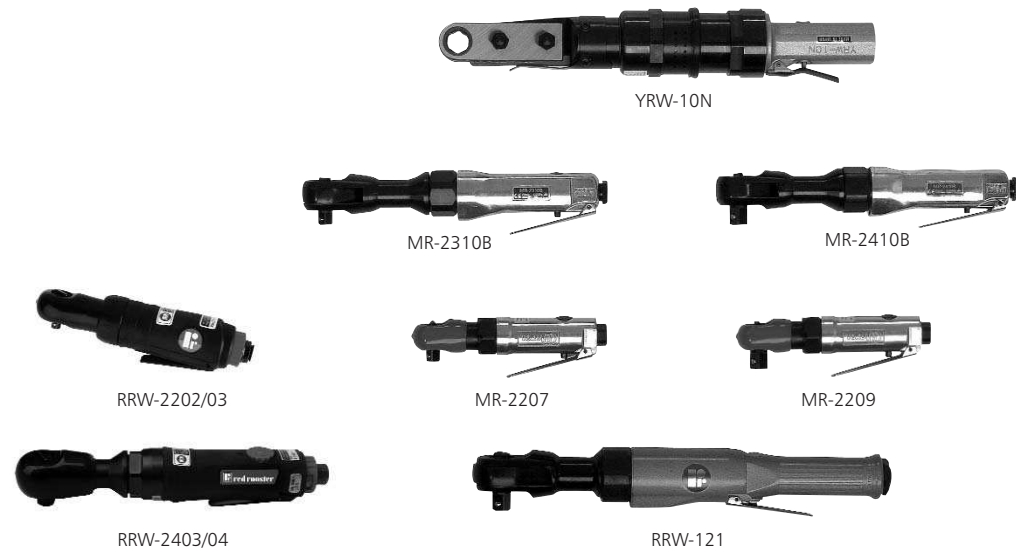

Dimensions

Type	A mm	B mm	C mm	D mm	E mm	F mm
MR-2207C	165	33	-	-	-	-
MR-2209C	165	33	-	-	-	-
MR-2310B	255	44	-	-	-	-
MR-2410B	255	50	-	-	-	-
RRW-121	357	57	-	-	-	-
RRW-2202	180	32	-	-	-	-
RRW-2203	180	32	-	-	-	-
RRW-2403	250	40	-	-	-	-
RRW-2404	250	45	-	-	-	-
YRW-6	320	13	13	88	20	10
YRW-8NS	350	18	13	105	25	12.5
YRW-10N	388	18	18	108	33	16.5

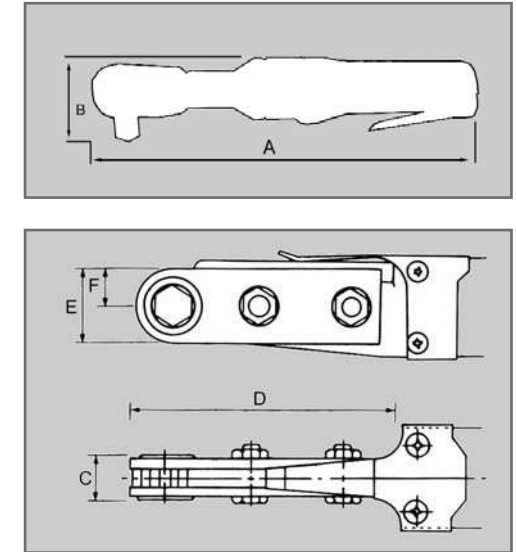

Type	Brand	Square-drive	Bolt capacity mm	Rotations p/min	Torque Nm	Air-cons. l/sec	Weight kg	Inlet-thread	Hose diameter mm	Vibration m/s ²	Noise level dB(A)
RRW-2202	RRA	1/4"	8	270	32	5.0	0.5	PT 1/4"	6.5	4.3	85
MR-2207C	TOKU	1/4"	8	250	28	5.0	0.5	PT 1/4"	6.5	2.7	81
RRW-2203	RRA	3/8"	10	270	32	5.0	0.5	PT 1/4"	6.5	4.3	85
MR-2209C	TOKU	3/8"	10	250	28	5.0	0.5	PT 1/4"	6.5	2.7	81
RRW-2403	RRA	3/8"	12	150	68	6.0	1.2	PT 1/4"	6.5	5.8	85
MR-2310B	TOKU	3/8"	12	175	78	6.0	1.2	PT 1/4"	6.5	3	85
RRW-2404	RRA	1/2"	12	150	68	6.0	1.2	PT 1/4"	6.5	5.8	85
MR-2410B	TOKU	1/2"	12	175	78	6.0	1.2	PT 1/4"	6.5	1.3	81
RRW-121	RRA	1/2"	12	135	120	8.0	1.9	PT 1/4"	10	2.3	88

Ratchet wrenches for the assembly industry

YRW-6	YOKOTA	8, 9, 10 *	6	200	13	4.6	1.15	PT 1/4"	9	2.5	81
YRW-8NS	YOKOTA	10, 12, 13, 14 *	8	250	30	8.3	2.00	PT 1/4"	9	2.5	82
YRW-10N	YOKOTA	14, 17 *	10	140	45	11.6	2.65	PT 1/4"	9	2.5	84

* Socket size in mm / standard for YRW-6 : 10 mm / YRW-8NS : 12 mm / YRW-10N : 17 mm
Please state socket size in your order.

Impact sockets

Choose the right size impact socket for your ratchet wrench. If the sockets do not fit exactly this may cause a loss of power and wear of the anvil. For detailed information about the impact sockets we refer to the special chapter Action impact sockets. Extension bars, universal joints and adaptors are also available.



4. Screwdrivers

Applications and mechanisms

Screwdrivers are available with various impact mechanisms. Each application has its own mechanism. Therefore please take note of the information below before purchasing a tool.

1-Hammer

The 1-hammer system makes 1 impact per rotation at 1 side of the anvil. This causes a higher energy per blow. The screwdrivers with the 1-hammer system are especially suitable for wood and steel screws.

2-Hammer

The 2-hammer system makes 2 impacts per rotation at both sides of the anvil. This mechanism is used for wood and steel screws and works more quiet than the 1-hammer system.

Direct drive

These direct drive screwdrivers are suitable for selftapping screws and wood screws.

Clutch mechanism

Screwdrivers with a clutch type mechanism are used for standard applications with normal joints. The mechanism works by means of spring pressure. When reaching the torque the mechanism slips.

Shut-off mechanism

To comply with the ever increasing demands for screwdriving accuracy and work safety, we present a new range of pneumatic screwdrivers with a maximum torque repeatability. Along with the exceptional torque accuracy, the new Jointech Plus 2 torque control system has automatic high speed air shut off to allow for a considerable reduction of the reaction to the operator's hand.

Screwdrivers

Hammermechanism / Direct drive



Type	Brand	Square / Hex drive	Bolt capacity mm	Model	Rotations p/min	Torque Nm	Air-cons. l/sec	Weight kg	Inlet-thread	Hose-diameter mm	Vibration m/s ²	Noise level dB(A)
------	-------	--------------------	------------------	-------	-----------------	-----------	-----------------	-----------	--------------	------------------	----------------------------	-------------------

1-Hammer

YD-3A ¹	YOKOTA	1/4" Hex	4	Straight	12.000	7.5	1.6	0.50	PT 1/8"	6.5	2.3	82
YD-4A ¹	YOKOTA	1/4" Hex	5	Straight	11.000	12.0	2.3	0.60	PT 1/8"	6.5	2	90
YD-5A ¹	YOKOTA	1/4" Hex	6	Straight	10.000	15.5	3.2	0.85	PT 1/8"	6.5	2.5	90

2-Hammer

MID-600 ²	TOKU	1/4" Hex	3-5	Pistol	9.500	90	5.0	0.9	PT 1/4"	8.0	3.6	82
YD-40PZ	YOKOTA	1/4" Hex	4	Pistol	14.000	15	1.6	0.52	PT 1/4"	6.5	4	80
YD-600SZ ²	YOKOTA	1/4" Hex	6	Straight	7.500	37	5.0	0.95	PT 1/4"	6.5	1.6	77
YD-670-RF ³	YOKOTA	1/4" Hex	6	Pistol	7.500	90	6.1	0.98	PT 1/4"	6.5	1.5	75

Direct drive

RR-8724	RRA	1/4" Hex	6	Pistol	800	10.5	10.3	1.4	PT 1/4"	10	8.5	86
RR-8725	RRA	1/4" Hex	6	Pistol	1.800	7.5	9.8	1.0	PT 1/4"	10	8.5	86

¹ = Supplied with regulator

² = Air supply adjustable with 4 step button

³ = Supplied with rubber protection cover

Clutch- / Shut-off mechanism



Type	Brand	Square / Hex drive	Bolt capacity mm	Model	Rotations p/min	Torque Nm	Air-cons. l/sec	Weight kg	Inlet-thread	Hose-diameter mm	Vibration m/s ²	Noise level dB(A)
------	-------	--------------------	------------------	-------	-----------------	-----------	-----------------	-----------	--------------	------------------	----------------------------	-------------------

Clutch type mechanism (adjustable)

YD-400SCA	YOKOTA	1/4" Hex	4	Straight	1.700	1.0-3.2	2.5	0.56	PT 1/8"	6.5	4	77
YD-5PHCA	YOKOTA	1/4" Hex	5	Pistol	1.650	1.0-6.6	5.8	1.20	PT 1/4"	6.5	2	77
RR-550	RRA	1/4" Hex	6	Pistol	750	5.0-16	10.0	1.50	PT 1/4"	6.4	1.6	80
RR-580	RRA	1/4" Hex	6	Straight	800	5.0-16	10.0	1.20	PT 1/4"	9.0	1.6	80

Shut-off mechanism (adjustable)

RRI-0830SP	RRI	1/4" Hex	4	Straight	1.300	1.0-3.0*	2.6	0.60	PT 1/8"	6.5	<2.5	70
RRI-0830SL	RRI	1/4" Hex	4	Straight	1.300	1.0-3.0*	2.6	0.65	PT 1/8"	6.5	<2.5	70
RRI-2580SP	RRI	1/4" Hex	5	Straight	1.000	2.5-8.0	8.0	0.87	PT 1/4"	9.0	<2.5	77
RRI-0445P	RRI	1/4" Hex	5	Pistol	950	0.4-4.5	6.0	0.72	PT 1/4"	9.0	<2.5	71
RRI-25100P	RRI	1/4" Hex	6	Pistol	500	2.5-10.0	6.3	1.10	PT 1/4"	9.0	<2.5	74

RRI-0251AOT	RRI	1/4" Hex	4	Pistol	550	0.2-5.1	6.3	0.9	PT 1/4"	6.5	<2.5	83
RRI-0345AOT	RRI	1/4" Hex	4	Pistol	1.100	0.3-4.5	6.3	0.9	PT 1/4"	6.5	<2.5	83
RRI-0529AOT	RRI	1/4" Hex	4	Pistol	1.700	0.5-2.9	6.3	0.9	PT 1/4"	6.5	<2.5	83
RRI-0251S	RRI	1/4" Hex	4	Straight	550	0.2-5.1	6.3	0.9	PT 1/4"	6.5	<2.5	83
RRI-0345S	RRI	1/4" Hex	4	Straight	1.400	0.3-4.5	6.3	0.9	PT 1/4"	6.5	<2.5	83
RRI-0529S	RRI	1/4" Hex	4	Straight	1.700	0.5-2.9	6.3	0.9	PT 1/4"	6.5	<2.5	83

* Hard joint

Soft joint: RRI-0830 SP/SL = 0.8 - 2.5

See next page for screwdriver controls.

Screwdrivers

Control and accessories



Push start
RRI-2580SP



Lever control
RRI-0830SL



Trigger start
RRI-25100P



4-step trigger
YD-670-RF



2-step trigger
YD-5PHCA



1-Hammer

YD-3A	Push start
YD-4A	Push start
YD-5A	Push start

2-Hammer

MID-600	Trigger start
YD-40PZ	2-step trigger
YD-600SZ	Lever control
YD-670A-RF	4-step trigger

Direct drive

RR-8724	Trigger start
RR-8725	Trigger start

Clutch type mechanism (adjustable)

YD-400SCA	Push start
YD-5PHCA	2-step trigger
RR-550*	Trigger start
RR-580*	Lever control

Shut-off mechanism (adjustable)

RRI-0830SP	Push start
RRI-0830SL	Lever control
RRI-2580SP	Push start
RRI-0445P	Trigger start + Push start
RRI-25100P	Trigger start + Push start

RRI-0251AOT*	Trigger start + Push start
RRI-0345AOT*	Trigger start + Push start
RRI-0529AOT*	Trigger start + Push start
RRI-0251S*	Push start
RRI-0345S*	Push start
RRI-0529S*	Push start

* Models are supplied with 3 different torque springs (light - medium - heavy), to set different levels of torque.

Spring balancers

In order to support the weight of tools, the use of a spring balancer should be considered. The performance of the tool will be speeded up due to good balance and reduced operator fatigue, when using a spring balancer. For more information we refer to the special chapter (page 136-137).

The YD-400SCA and YD-5PHCA are supplied as standard with set screw spanner number 2201-0234-00-00.

Automotive models RR-550 and RR-580 are supplied with 3 torque springs (10 Nm low, 12 Nm medium and 16 Nm high).

Dimensions

Type	A mm	B mm	C mm
MID-600	149	22	161
RR-550	227	150	155
RR-580	260	50	-
RR-8724	185	20	155
RR-8725	200	20	155
RRI-0445P	178	15	156
RRI-0830SP	220	15	-
RRI-0830SL	240	15	-
RRI-2580SP	245	20	-
RRI-25100P	245	20	155
RRI-0251AOT	220	14	140
RRI-0345AOT	220	14	140
RRI-0529AOT	220	14	140
RRI-0251S	240	15	-
RRI-0345S	240	15	-
RRI-0529S	240	15	-
YD-3A	168	13.5	-
YD-4A	180	16	-
YD-5A	200	19	-
YD-5PHCA	217	20	154
YD-40PZ	107	18	125
YD-400SCA	209	16.5	-
YD-600SZ	206	23	-
YD-670A-RF	149	22	167

Note: All screwdrivers adopt 1/4" standard type hexagon insert bits and are reversible.

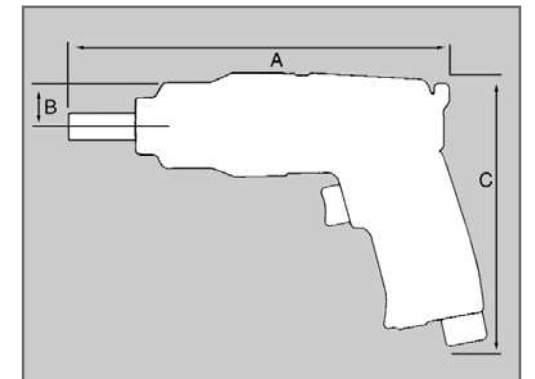
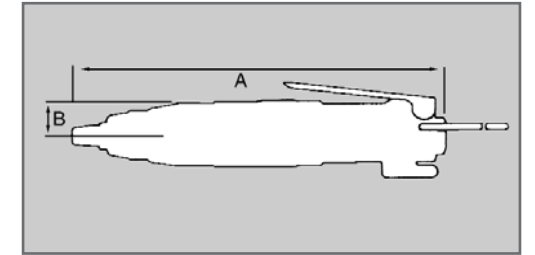

RR-8724



RR-580

5. Drills

Various models



Drills

The drills are suitable for a large number of applications. Both for use in the industry, steel and aluminium processing, car manufacturing, truck manufacturing, home electrical appliances, but also the general use in the workshop is covered.

The Yokota drills are executed with a 2-step trigger. The first step is used for setting the drill in the right spot of the workpiece, the second step is used for drilling the hole at high speed. The silencers can be turned 360 degrees.

Please take care to choose the right drill for the right capacity. Capacity and RPM of the tool are designed to fit to each other.

Drills

Capacity 6 - 16 mm



Type	Brand	Capacity steel mm	Spindle size	Rotation direction	Rotations p/min	Power kW	Air-cons. l/sec	Weight kg	Inlet-thread	Hose diameter mm	Vibration m/s ²	Noise level dB(A)
------	-------	-------------------	--------------	--------------------	-----------------	----------	-----------------	-----------	--------------	------------------	----------------------------	-------------------

Pistol models

RRI-2006	RRI	6.5	3/8" x 24 UNF	Right	5.000	0.21	10.8	0.65	PT 1/4"	8	3	79
RRI-2206/28	RRI	6.5	3/8" x 24 UNF	Right	2.800	0.26	7.6	0.60	PT 1/4"	8	0.4	84
RRI-2206/40	RRI	6.5	3/8" x 24 UNF	Right	4.000	0.26	7.6	0.60	PT 1/4"	8	0.6	86
YRD-6N BK	YOKOTA	6-8	3/8" x 24 UNF	Right	2.800	0.33	8.3	0.90	PT 1/4"	8	3	76
YRD-8N BK	YOKOTA	8-10	3/8" x 24 UNF	Right	1.900	0.38	10.0	1.30	PT 1/4"	8	3	75
MD-10L	TOKU	10	3/8" x 24 UNF	Right	2.300	0.30	8.0	0.90	PT 1/4"	8	1.3	73
10RD-2005 BK	RRA	10	3/8" x 24 UNF	Right	2.600	-	8.0	1.10	PT 1/4"	6.5	1.6	78
10RDR-1800 BK	RRA	10	3/8" x 24 UNF	L + R	1.800	-	8.0	1.36	PT 1/4"	6.5	4	78
YRD-10N BK	YOKOTA	10-13	1/2" x 20 UNF	Right	1.000	0.44	10.0	1.50	PT 1/4"	10	1.3	80
YRD-13N BK	YOKOTA	13	1/2" x 20 UNF	Right	700	0.50	13.3	1.6	PT 1/4"	10	0.8	79
13RD-755 BK	RRA	13	3/8" x 24 UNF	Right	500	-	7.7	1.8	PT 1/4"	6.5	0.8	78
RRI-2116P *	RRI	16	1/2" x 20 UNF	Right	950*	0.50	11.0	2.4	PT 1/4"	10	1.8	82

Angle models

MD-3312B	TOKU	10	3/8" x 24 UNF	L + R	1.900	-	6.0	0.91	PT 1/4"	6.5	2.3	77
----------	------	----	---------------	-------	-------	---	-----	------	---------	-----	-----	----

* Max. 950 p/min Min. 650 p/min

* Supplied with exhaust hose.

Dimensions / Accessories

Dimensions

Type	A mm	B mm	C mm
10RD-2005 BK	164	156	21
10RDR-1800 BK	156	165	21
13RD-755 BK	201	156	21
MD-10L	162	140	22
MD-3312B	205	93	20
RRI-2006	192	138	14
RRI-2206/28	128	116	14
RRI-2206/40	128	116	14
RRI-2116P	270	168	28
YRD-6N BK	151	140	21
YRD-8N BK	176	150	25
YRD-10N BK	209	150	25
YRD-13N BK	218	145	25

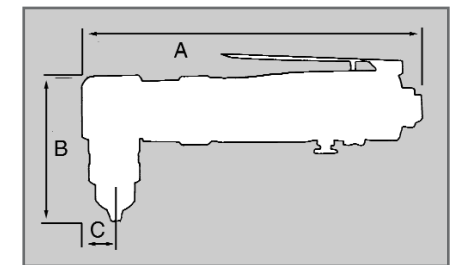
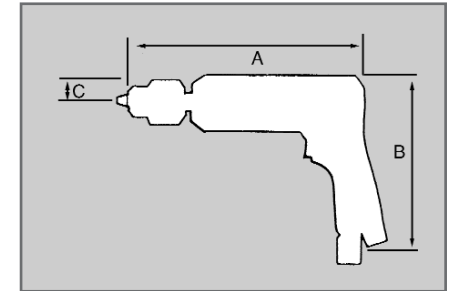

Accessories

■ Drill chucks

Type	Order number
MD-10L	* BH-10 mm 3/8" x 24
MD-3312B	* BH-10 mm 3/8" x 24
13RD-755BK	BH-13 mm 3/8" x 24
RRI-2206/28	* BH-6 mm 3/8" x 24
RRI-2206/40	* BH-6 mm 3/8" x 24
RRI-2116P	* Röhm BH P-16 1/2" x 20

■ Quickchange drill chucks

Type	Order number
10RD-2005 BK	* BHS-10 mm 3/8" x 24
10RDR-1800 BK	* BHS-10 mm 3/8" x 24
YRD-6N BK	* Röhm BHS-10 mm 3/8" x 24
YRD-8N BK	* Röhm BHS-10 mm 3/8" x 24
YRD-10N BK	* Röhm BHS-13 mm 1/2" x 20
YRD-13N BK	* Röhm BHS-13 mm 1/2" x 20
13RD-755 BK	* Röhm BHS-13 mm 1/2" x 20

■ Side handles

Type	Order number
13RD-755BK	* SM71239 + SM71240
RRI-2116P	* 2116-061-99

■ Keys for drill chucks

Type	Order number
MD-10L	* 90180
MD-3312 B	* 90180
RRI-2116P	* 90200
RRI-2206/28	* 90160
RRI-2206/40	* 90160

* Supplied as standard

6. Dowel pin pullers

For matrix, casting and press-moulding



Dowel pin pullers

The Yokota dowel pin puller is used in matrix, casting and press-moulding industries, for setting and removing dowel pins in moulds or presses. The dowel pin puller is an easily operated air tool and can simplify the pulling or hammering operation of the threaded dowel pins, saving time and improving working efficiency.

Dowell pin pullers

For matrix, casting and press-moulding

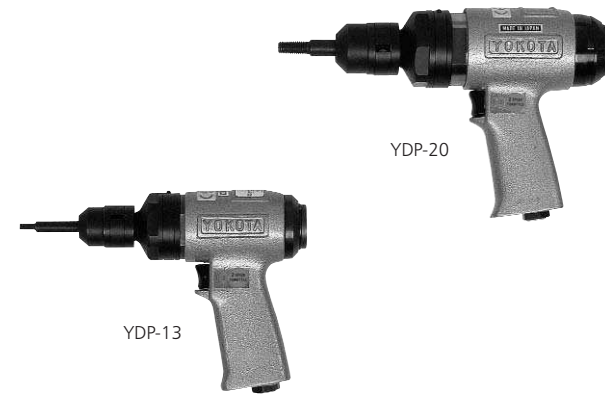

Type	Brand	Capacity pin mm	Stroke mm	Blows p/min	Air-cons. l/sec	Weight kg	Inlet-thread	Hose diameter mm
YDP-13	YOKOTA	13	30 x 25	5.000	3.3	1.35	PT 1/4"	9.5
YDP-20	YOKOTA	20	36 x 33	2.700	4.3	2.10	PT 1/4"	9.5

Dimensions / Accessories

Dimensions

Type	A mm	B mm
YDP-13	162	75
YDP-20	195	82

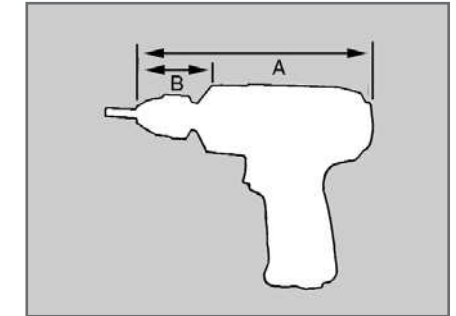

Accessories

Hanger bolts for YDP-13	Order number	Hanger bolts for YDP-20	Order number
M8 x 29L	6502-0022-00-01	M12 x 36L	6503-0022-00-01
M6 x 23L	6502-0022-00-02	M10 x 33L	6503-0022-00-02
M5 x 21L	6502-0022-00-03	M8 x 32L	6503-0022-00-03
M4 x 21L	6502-0022-00-04	M8 x 100L	6503-0022-00-04
M8 x 50L	6502-0022-00-05	M8 x 150L	6503-0022-00-05
M8 x 100L	6502-0022-00-06	M8 x 200L	6503-0022-00-06
M8 x 150L	6502-0022-00-07	M10 x 100L	6503-0022-00-07
M8 x 200L	6502-0022-00-08	M10 x 150L	6503-0022-00-08
M6 x 50L*	6502-0022-00-09	M10 x 200L	6503-0022-00-09
M6 x 100L	6502-0022-00-10	M12 x 100L	6503-0022-00-10
M6 x 150L	6502-0022-00-11	M12 x 150L	6503-0022-00-11
M6 x 200L	6502-0022-00-12	M12 x 200L	6503-0022-00-12
M5 x 50L*	6502-0022-00-13	M8 x 50L*	6503-0022-00-13
M5 x 100L	6502-0022-00-14	M10 x 50L*	6503-0022-00-14
M5 x 150L	6502-0022-00-15	M12 x 50L*	6503-0022-00-15
M5 x 200L	6502-0022-00-16	M6 x 50L	6503-0022-00-16
M4 x 50L*	6502-0022-00-17		
M4 x 100L	6502-0022-00-18		
M4 x 150L	6502-0022-00-19		
M4 x 200L	6502-0022-00-20		

L = Length
* = Supplied as standard

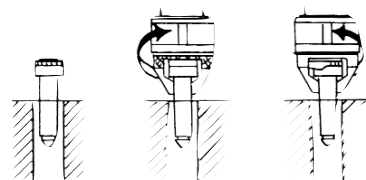

Pulling operation

- 1 Screw hanger bolt to threaded pin
- 2 Fit dowel pin to guide hole
- 3 Lock hanger bolt
- 4 Operate the tool to pull up the pin

Hammering operation

- 1 Screw hanger bolt to threaded pin
- 2 Fit dowel pin to guide hole
- 3 Operate the tool to hammer dowel pin
- 4 Start the tool

7. Grinders and sanders

Applications



Die grinders

Die grinders of the brands Yokota, Toku and Red Rooster are used for most light dressing / fettling applications on fabrications and die setting sets.

Angle grinders

Also angle grinders of the brands Yokota, Toku and Red Rooster are available. Suitable for fettling / fabrication of steel / cast iron.

Vertical grinders

Yokota's vertical grinders are used for various applications. Suitable for fettling / fabrication of steel / cast iron.

Straight grinders

Type GS-2EFS is a Yokota straight grinder. This grinder is used for fabrication and medium grinding applications. Type TSG are Toku straight grinders.

Sanders

The sanders are available in various models, suitable for metal finishing and woodworking applications.

Belt sanders

The Red Rooster belt sanders are suitable for nearly all materials, e.g. steel, aluminium, plastics and wood and for use as a de-burring method in difficult access fettling applications. All belt sanders are executed with safety handle and adjustable silencer.

Grinders

Die models

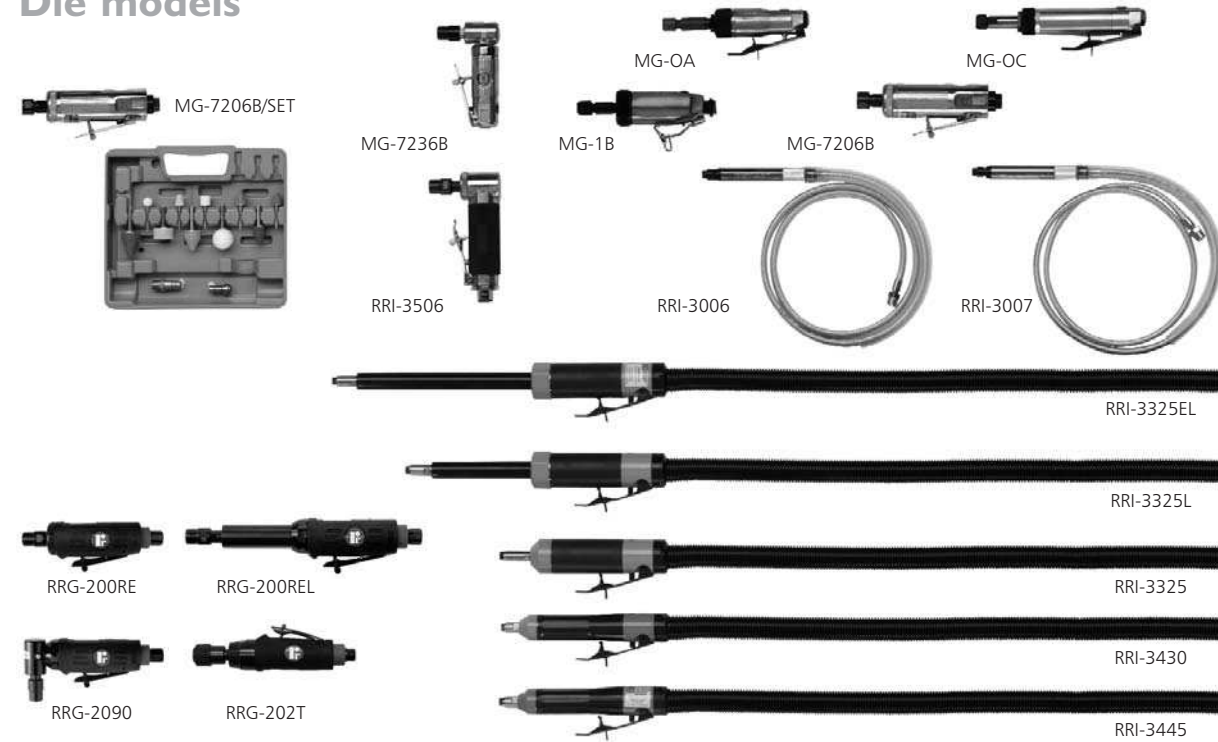

Type	Brand	Wheel size mm	Rotations p/min	Power kW	Collet chuck mm	Air cons. l/sec	Weight kg	Inlet-thread	Hose diameter mm	Vibration m/s ²	Noise Level dB(A)
RRI-3007	RRI	9	70.000	0.08	3	1.6	0.35	PT 1/4"	6.5	1.2	77
RRI-3006	RRI	12	58.000	0.10	3	1.6	0.35	PT 1/4"	6.5	0.8	80
RRI-3445	RRI	20	45.000	0.23	3 / 6	7.5	0.40	PT 1/4"	8	2.4	79
MG-OC	YOKOTA	25	33.000	0.13	6	3.0	0.39	PT 1/4"	10	3	78
RRI-3430	RRI	20	30.000	0.23	3 / 6	7.5	0.40	PT 1/4"	8	2.2	81
MG-OA	YOKOTA	20	25.000	0.24	6	6.2	0.45	PT 1/4"	10	5	78
RRI-3325	RRI	35	25.000	0.50	6	11.0	0.70	PT 1/4"	10	3	76
RRG-200RE	RRA	35	25.000	0.25	6	4.0	0.56	PT 1/4"	6.5	2.5	83
MG-7206B	TOKU	25	23.000	0.38	6	5.0	0.56	PT 1/4"	6.5	2.3	81
RRG-200REL	RRA	35	25.000	0.25	6	4.0	0.86	PT 1/4"	6.5	1.5	83
RRI-3325L	RRI	35	25.000	0.50	6	11.0	0.70	PT 1/4"	10	4	76
RRI-3325EL	RRI	35	25.000	0.50	6	11.0	0.75	PT 1/4"	10	4	76
RRG-2090*	RRA	35	20.000	0.23	6	4.0	0.56	PT 1/4"	6.5	2.4	84
RRI-3506*	RRI	40	18.000	0.22	6	4.9	0.55	PT 1/4"	10	1	80
MG-7236B*	TOKU	40	20.000	0.20	6	5.0	0.45	PT 1/4"	10	2	85
MG-1B	TOKU	45	18.000	0.28	6	8.0	0.55	PT 1/4"	10	1.3	77
RRG-202T**	RRA	80	2.500	0.3	7/16" HEX	4.0	1.1	PT 1/4"	6.5	2	84

* Angle model
** Tire buffer

Collet chucks for die grinders are supplied with the tool.

The RRI-3325L and RRI-3325EL are the same. However model RRI-3325EL is supplied with an extended spindle (not suitable for wire brushes).

Types MG-7236B, RRI-3506 and RRG-2090 can only be delivered with an angle head. The only exception with die-grinders! Note: *MG-7206B* and *RRG-200RE* also in set (including assortment of burrs).

Angle models



Type	Brand	Wheel size mm	Rotations p/min	Power kW	Spindle (Whitworth)	Air cons. l/sec	Weight kg	Inlet-thread	Hose diameter mm	Vibration m/s ²	Noise Level dB(A)
TAG-40FLH*	TOKU	100 x 6 x 16	13.000	0.55	M10	10.8	1.70	PT 3/8"	10	2.6	83
RRG-2034	RRA	100 x 6 x 16	12.500	0.45	M10	11.0	1.55	PT 1/4"	10	2.3	83
HS-4G	YOKOTA	100 x 6 x 16	12.000	0.48	M12 x 1,25	9.2	1.40	PT 1/4"	10	4	89
G-40SRF	YOKOTA	100 x 6 x 16	13.000	0.39	M8 x 1.25	7.5	0.90	PT 1/4"	6.5	6.6	79
G-40EF	YOKOTA	115 x 6 x 22	13.000	0.60	7/16"	10.8	1.40	PT 1/4"	10	6.6	79
G-40RF	YOKOTA	115 x 6 x 22	13.000	0.60	7/16"	10.8	1.30	PT 1/4"	10	6.6	79
TAG-45MLH*	TOKU	115 x 6 x 22	13.000	0.55	M14x2	10.8	1.80	PT 3/8"	10	2.7	83
RRG-2044	RRA	115 x 6 x 22	12.500	0.45	M14x2	11.0	1.60	PT 1/4"	10	2.4	83
G-50EF	YOKOTA	125 x 6 x 22	12.000	0.60	7/16"	10.8	1.50	PT 1/4"	10	4	77
G-50RF	YOKOTA	125 x 6 x 22	12.000	0.60	7/16"	10.8	1.40	PT 1/4"	10	4	77
TAG-50MLH*	TOKU	125 x 6 x 22	12.000	0.55	M14x2	10.8	1.80	PT 3/8"	10	2.7	83
RRG-2055	RRA	125 x 6 x 22	12.000	0.45	M14x2	11.0	1.60	PT 1/4"	10	2.4	83
G-70EF	YOKOTA	180 x 6 x 22	8.500	1.12	5/8"	16.7	2.90	PT 3/8"	13	2.3	82
TAG-700 QJL*	TOKU	180 x 6 x 22	8.500	1.10	**	16.6	3.10	PT 3/8"	13	2.6	82
TAG-900 QJL*	TOKU	230 x 6 x 22	6.500	1.10	**	16.6	3.10	PT 3/8"	13	3.6	82

EF safety trigger (all other grinders have a safety lever)

* Vibration reduced handle

** Adapters on page 71.

RRG-models are supplied with flanges for wheel thickness of 0,8 - 6 mm.

TAG-45MLH and TAG-50MLH are supplied with flanges for wheel thickness of 1,6 - 6 mm.

All angle grinders are supplied with regulator (for optimal safety and the correct RPM for best material removal).

All angle grinders are supplied with side handle, with exception of model G-40SRF. All TAG- and RRG-models are supplied with vibration reduced side handle.

Flanges for cup wheels and a tool service set for mounting the flanges are supplied with all grinders.

Grinders

Vertical / Straight



Type	Brand	Wheel size mm	Rotations p/min	Power kW	Spindle (Whitworth)	Air cons. l/sec	Weight kg	Inlet-thread	Hose diameter mm	Vibration m/s ²	Noise Level dB(A)
------	-------	---------------	-----------------	----------	---------------------	-----------------	-----------	--------------	------------------	----------------------------	-------------------

Vertical grinders

7VC-6500FS	YOKOTA	230 x 6 x 22	6.500	1.65	5/8"	23.0	4.2	PT 3/8"	13	3	82
7VC-8500FS	YOKOTA	180 x 6 x 22	8.500	1.85	5/8"	23.0	4.1	PT 3/8"	13	2.1	83

Straight grinders

GS-2EFS	YOKOTA	65 x 13 x 9.5	14.000	0.45	3/8" x 16	10.0	1.3	PT 1/4"	10	3	84
TSG-3L	TOKU	75 x 13 x 9.5	11.500	0.53	3/8"	8.3	1.6	PT 3/8"	13	0.8	73
TSG-4L	TOKU	100 x 19 x 12.7	9.000	1.05	5/8"	16.6	3.0	PT 3/8"	13	1.1	83
TSG-5L	TOKU	125 x 19 x 12.7	7.600	1.05	5/8"	16.6	3.0	PT 3/8"	13	1.5	79
TSG-6L	TOKU	150 x 25 x 15.9	6.000	1.58	5/8"	20.0	4.2	PT 3/8"	13	0.8	80

FS Silenced

Both Yokota and Toku straight grinders have double rows of bearings for long lifetime.

All vertical and straight grinders have a governor wheel for regulating the right speed of the grinding wheel. This reduces the risk of overspeeding and assures the best material removal.

Dimensions

Type	A mm	B mm	C mm	D mm	E mm
7VC-6500FS	195	180	180	160	-
7VC-8500FS	195	180	180	165	-
G-40EF	299	88	29	50	-
G-40RF	200	88	29	50	-
G-40SRF	196	65	25	40	-
G-50EF	299	88	29	50	-
G-50RF	200	88	29	50	-
G-70EF	341	107	37	60	-
GS-2EFS	350	51	-	-	-
HS-4G	125	118	145	105	-
MG-OA	170	29	15	55	62
MG-OC	197	33	20	50	56
MG-1B	162	43	19	46	48
MG-7206B	164	40	-	-	-
MG-7236B	125	35	17	75	-
RRG-200RE	162	40	18	30	34
RRG-200REL	258	40	18	116	135
RRG-2090	167	40	-	-	-
RRG-202T	233	44	31	52	92
RRG-2034	215	95	25	50	-
RRG-2044	215	95	25	50	-
RRG-2055	215	95	25	50	-
RRI-3006	151	16	10	-	-
RRI-3007	151	16	10	-	-
RRI-3325	194	42	12	31	-
RRI-3330	193	35	13	15	-
RRI-3335	193	35	13	15	-
RRI-3325 L	315	42	12	150	-
RRI-3325 EL	400	42	12	240	-
RRI-3430	190	34	14	16	22
RRI-3445	190	34	14	16	22
RRI-3506	154	38	20	32	-
TAG-40FLH	267	85	33	50	-
TAG-45MLH	267	85	33	50	-
TAG-50MLH	267	85	33	50	-
TAG-700 QJL	307	103	36	62	-
TAG-900 QJL	307	103	36	62	-
TSG-3L	305	51	-	-	-
TSG-4L	400	80	-	-	-
TSG-5L	400	80	-	-	-
TSG-6L	430	80	-	-	-

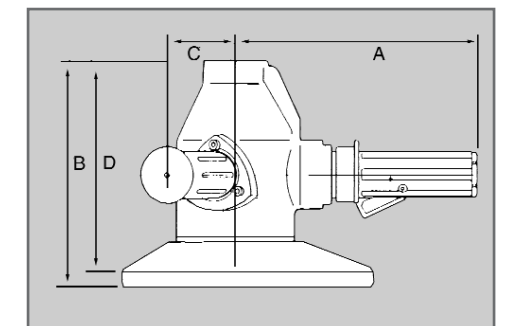
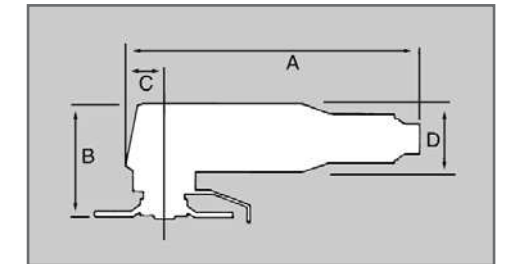
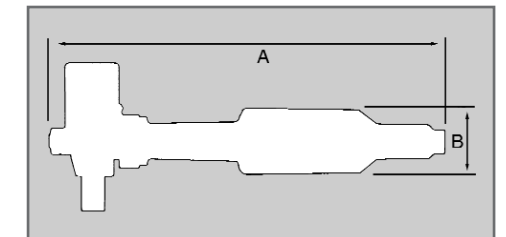
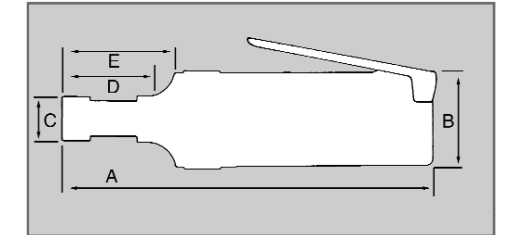

Flanges for cup wheels and a tool service set for mounting the flanges are supplied with all grinders.

Grinders

Accessories



Collet chucks

MG-7206B	NVK-A10	3 mm
GS-2EFS / TSG-3L	1104-0661-01-99	6 mm
	1001-0659-00-01	3 mm
MG-OC	1011-0661-00-00	* 6 mm
MG-OA	1013-0661-01-99	* 6 mm
MG-1B	42-04-90-K10	* 6 mm
MG-7206B	EG7206033	* 6 mm
MG-7236B	3003-035-00	* 6 mm
RRI-3325(L/EL)	3320-030-00	* 6 mm



Adapters

MG-OC	1001-0659-00-01	3 mm
MG-OA		for 6 mm
MG-1B		collet chuck
MG-7206B		
MG-7236B		
RRI-3325(L/EL)		



Tools for mounting grinding wheels

HS-4G	8081-0021-00-00	* Spanner H36
HS-4G	8100-2001-00-00	* Forked wrench
G-40	8100-1003-00-00	* Bar wrench
G-50		
G-40	8100-2001-00-00	* Forked wrench
G-50		
G-40	8100-3001-00-00	* L-wrench
G-50		
G-70EF	8100-5002-00-00	* Twin wrench
7VC6500FS		
7VC8500FS		
G-70EF	8081-0020-00-00	* Spanner H32
7VC6500FS		
7VC8500FS		
TAG-40FLH	8081-0022-00-00	* Spanner H41
TAG-45MLH		
TAG-50MLH		
TAG-700QJL		
TAG-900QJL		
TAG-40FLH	9610-1010-00-00	* Hex wrench H10
TAG-45MLH		
TAG-50MLH		
TAG-700QJL		
TAG-900QJL		

* Supplied as standard.

** These products are supplied in sets with rubber pads and flanges.



Rubber pads

G-40SRF	9310-3001-00-00	Disc
TAG-40FLH		90 x 16 mm
HS-4G		Paper
		100 x 16 mm
TAG-45MLH	9310-3008-00-00	Disc
TAG-50MLH		100 x 22 mm
		Paper
		115 x 22 mm
G-40EF/RF	9310-3003-00-00	** Disc
		110 x 16 mm
		Paper
		115 x 22 mm
G-50EF/RF	9310-3004-00-00	** Disc
		120 x 16 mm
		Paper
		125 x 22 mm
G-70EF	9310-3006-00-00	** Disc
7VC-6500FS		175 x 22 mm
7VC-8500FS		Paper
		180 x 22 mm
TAG-700 QJL	9310-3007-00-00	Disc
		175 x 22 mm
		Paper
		180 x 22 mm



Accessories for rubber pads

G-40EF/RF	1120-0658-00-00	** Outer flange
G-50EF/RF		
G-40RF/EF	1120-655-00-00	** Outer wheel screw
G-50RF/EF		
G-70EF	1508-0653-01-02	** Inner flange
7VC-6500FS		
7VC-8500FS		
G-70EF	1508-0654-05-05	Outer flange
7VC-6500FS		
7VC-8500FS		



Standard flanges and outer wheel screws

G-40EF/RF	9310-3003-00-99	Disc
		110 x 16 mm
		Paper
		115 x 22 mm
G-50EF/RF	9310-3004-00-99	Disc
		120 x 16 mm
		Paper
		125 x 22 mm
G-70EF	9310-3006-00-99	Disc
7VC-6500FS		175 x 22 mm
7VC-8500FS		Paper
		180 x 22 mm



Standard flanges and outer wheel screws

TAG-40FLH	42-05-77-171	* Outer flange
	13-17-08-020	* Outer wheel screw
TAG-45MLH	42-05-80-H00	* Outer flange
TAG-50MLH		*
TAG-700 QJL	2700-040-00	* Outer flange
	2700-041-00	* Outer wheel screw
G-40SRF	1105-0654-02-02	* Outer flange
	1105-0656-02-00	* Outer wheel screw
G-70EF	1422-0653-00-99	* Inner flange
7VC-6500/8500	1508-0654-00-01	* Outer flange
	1508-0655-00-00	* Outer wheel screw
HS-4G	1205-0653-00-00	* Inner flange
	1205-0654-00-01	* Outer flange
	1126-0655-00-00	* Outer wheel screw
RRG-2034	5D-619238	* Inner flange
RRG-2044	5D-619240	* Outer flange
RRG-2055		
RRG-2044	QN-M14	M14x2 quicknut
RRG-2055		



Grinding wheel

GS-2EFS	9300-0005-00-00	65 x 13 x 9.5
---------	-----------------	---------------

Exhaust hose / silencer kit

RRG-2034	5D-619249	
RRG-2044		
RRG-2055		



Adapter

TAG-700 QJL	2700-090-00	for wire brushes
TAG-900 QJL		M14



Accessories for flat cut-off discs

G-70EF	1508-0653-00-03	Inner flange
7VC-6500FS		
7VC-8500FS		
G-70EF	1508-0654-00-02	Outer flange
7VC-6500FS		
7VC-8500FS		



Accessories for cup stones / cup brushes

7VC-6500FS	1508-0653-01-02	Inner flange
7VC-8500FS		
7VC-6500FS	8100-4003-00-01	Angle spanner
7VC-8500FS		
7VC-6500FS	8100-1005-00-00	Pin spanner
7VC-8500FS		
7VC-6500FS	8100-5001-00-00	Double key spanner
7VC-8500FS		



Accessories for grinding wheels

G-40/G-50 EF/RF	1117-0653-00-01	Inner flange
		16 mm
G-40/G-50 EF/RF	1117-0654-00-01	Outer flange
		16 mm
G-40/G-50 EF/RF	1117-0653-00-02	* Inner flange
		22 mm
G-40/G-50 EF/RF	1117-0654-00-02	* Outer flange
		22 mm
G-40/G-50 EF/RF	1126-0655-00-00	* Outer wheel screw
		for 22 mm flange

Sanders

Orbital- and wire brush sanders



Type	Brand	Pad size mm	Rotations p/min	Power kW	Spindle	Air cons. l/sec	Weight kg	Inlet-thread	Hose diameter mm	Vibration m/s ²	Noise Level dB(A)
------	-------	-------------	-----------------	----------	---------	-----------------	-----------	--------------	------------------	----------------------------	-------------------

Orbital sanders

HS-4	YOKOTA	127 x 22	8.000 + 12.000	0.5	7/16" x 20	9.2	1.1	PT 1/4"	10	2	79
MS-4125B	TOKU	125 x 22	20.000	0.5	7/16" UNF	8.3	1.0	PT 1/4"	9	2.3	90
MS-230	TOKU	228 x 93	13.000	-	-	6.3	2.2	PT 1/4"	9	3.5	81
RRI-6NV ⁽²⁾	RRI	150	10.000	0.3	5/16" UNF	4.9	0.87	PT 1/4"	10	3.1	79
RRI-6NV-3 ⁽¹⁾	RRI	150	10.000	0.3	5/16" UNF	4.9	0.87	PT 1/4"	10	3.1	79
RRI-6CV ⁽²⁾	RRI	150	10.000	0.3	5/16" UNF	4.9	0.87	PT 1/4"	10	3.1	79
RRI-6CV-3 ⁽¹⁾	RRI	150	10.000	0.3	5/16" UNF	4.9	0.87	PT 1/4"	10	3.1	79
RRI-6SV ⁽²⁾	RRI	150	10.000	0.3	5/16" UNF	4.9	0.87	PT 1/4"	10	3.1	79
RRI-6SV-3 ⁽¹⁾	RRI	150	10.000	0.3	5/16" UNF	4.9	0.87	PT 1/4"	10	3.1	79

Wire brush sander

RRB-280	RRI	80 ⁽³⁾	8.000	0.45	M14 x 2 ⁽⁴⁾	9.6	1.5	PT 1/4"	10	9	80
---------	-----	-------------------	-------	------	------------------------	-----	-----	---------	----	---	----

- ⁽¹⁾ Stroke 3 mm
- ⁽²⁾ Stroke 5 mm
- ⁽³⁾ Size wire brush (supplied without wire brushes)
- ⁽⁴⁾ Spindle stainless steel

RRI-6 series are standard supplied with Velcro pad. Adhesive pads are optional.
 NV = non vacuum
 CV = for central vacuum
 SV = self vacuum, supplied with dustbag

Belt- and mini sanders



Type	Brand	Belt size mm	Rotations p/min	Power kW	Air cons. l/sec	Weight kg	Inlet-thread	Hose diameter mm	Vibration m/s ²	Noise Level dB(A)
------	-------	--------------	-----------------	----------	-----------------	-----------	--------------	------------------	----------------------------	-------------------

Belt sanders

RRG-3617K	RRI	6/10 x 330	16.000	0.28	6.7	0.75	PT 1/4"	8	0.6	80
RRG-3611	RRI	10 x 330	16.000	0.28	6.7	0.75	PT 1/4"	8	0.6	80
RRG-3621	RRI	20 x 520	16.000	0.34	8.7	1.40	PT 1/4"	8	2.5	79
RRG-3630	RRI	30 x 540	12.000	0.52	10.3	2.20	PT 1/4"	10	2	79

Type	Brand	Pad size mm	Rotations p/min	Power kW	Spindle	Air cons. l/sec	Weight kg	Inlet-thread	Hose diameter mm	Vibration m/s ²	Noise Level dB(A)
------	-------	-------------	-----------------	----------	---------	-----------------	-----------	--------------	------------------	----------------------------	-------------------

Mini sanders

RRS-6001 2K	RRA	50	15.000	0.3	ROLOC™	4.9	0.75	PT 1/4"	10	0.74	88
RRS-6001 3K	RRA	75	15.000	0.3	ROLOC™	4.9	0.75	PT 1/4"	10	0.74	88
RRS-6004 3K	RRA	75	2.500	0.3	-	4.9	0.90	PT 1/4"	10	0.74	88

The ROLOC™ system ensures fast and secure change of discs



RRS-6001 2K RRS-6001 3K RRS-6004 3K

RRS-6001 and RRS-6004 are supplied in a blow mould case, complete with the first sets of abrasives: 10 x grain 80, 10 x grain 100, 10 x grain 120 and surface prep-pads.

The Red Rooster belt sanders are suitable for nearly all materials, e.g. steel, aluminium, plastics and wood and for use as a de-burring method in difficult access fettling applications. All belt sanders are executed with safety handle and adjustable silencer.

RRG-3617K is the same as model RRG-3611, however supplied as set. This set contains a sanding arm 6 x 330 and a sanding arm 10 x 330 mm (1 tool, 2 applications).

Sanders

Accessories



Sanding pads	Order nr.	
HS-4	9350-1002-00-00*	Fiber, 115 x 22 mm
MS-4125B		
RRI-6CV/SV	6000-048-02	Adhesive-, Ø 150 mm
RRI-6CV/SV	6000-048-03	Velcro/adhesive-, Ø 150 mm
RRI-6NV	6000-045-02	Adhesive-, Ø 150 mm
RRI-6NV	6000-045-03	Velcro/adhesive-, Ø 150 mm



Side handle	Order nr.	
HS-4	1203-0013-00-99*	
TAG-** / RRG-20**	2400-046-11*	



Polishing pads	Order nr.	
RRS-6004	ROAS-75543VC	Yellow pad 3 1/2"
RRS-6004	ROAS-75653VC	White pad 3 1/2"
RRS-6004	ROAS-77213VC	Bonnett 3 1/2"



Sanding belt for 6 mm sanding arm		
SSB60660	6 x 330 mm	Grain 60
SSB60680	6 x 330 mm	Grain 80
SSB606100	6 x 330 mm	Grain 100
SSB606120	6 x 330 mm	Grain 120
SSB606150	6 x 330 mm	Grain 150

Sanding belt for 10 mm sanding arm		
SSB61060	10 x 330 mm	Grain 60
SSB61080	10 x 330 mm	Grain 80
SSB610100	10 x 330 mm	Grain 100
SSB610120	10 x 330 mm	Grain 120
SSB610150	10 x 330 mm	Grain 150

Sanding belt for 20 mm sanding arm		
SSB62060	20 x 520 mm	Grain 60
SSB62080	20 x 520 mm	Grain 80
SSB620100	20 x 520 mm	Grain 100
SSB620120	20 x 520 mm	Grain 120
SSB620150	20 x 520 mm	Grain 150

Sanding belt for 30 mm sanding arm		
SSB63060	30 x 540 mm	Grain 60
SSB63080	30 x 540 mm	Grain 80
SSB63100	30 x 540 mm	Grain 100
SSB63120	30 x 540 mm	Grain 120
SSB63150	30 x 540 mm	Grain 150

Dimensions

Type	A mm	B mm	C mm	D mm
HS-4	125	102	145	127
MS-230	170	90	115	-
MS-4125B	150	110	-	-
RRB-280	225	85	28	50
RRG-3610	50	265	-	-
RRG-3616K	50	265	-	-
RRG-3620	60	420	-	-
RRG-3630	60	490	-	-
RRI-6NV	150	106	-	-
RRI-6NV-3	150	106	-	-
RRI-6CV	150	106	-	-
RRI-6CV03	150	106	-	-
RRI-6SV	150	106	-	-
RRI-6SV-3	150	106	-	-
RRS-6001 2K	116	140	-	-
RRS-6001 3K	116	140	-	-
RRS-6004 3K	131	140	-	-

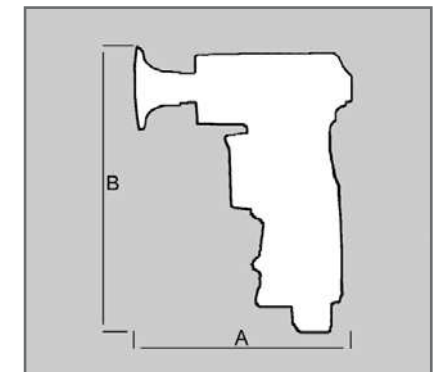
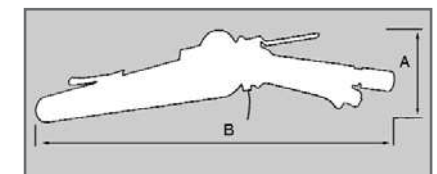
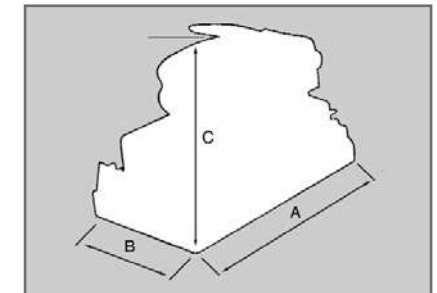
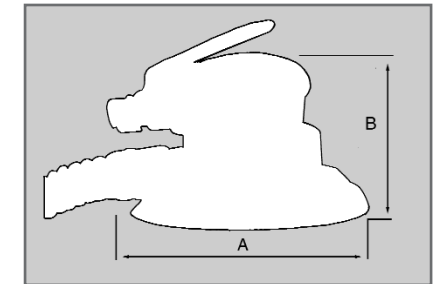
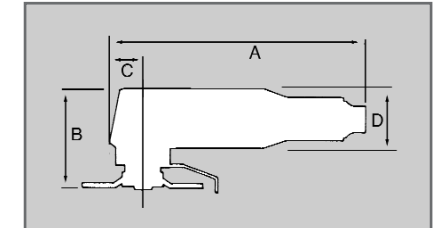

* Supplied as standard.

8. Hammers

Applications



The right hammer for every application

The air-hammers are developed for different uses. Whether you need to chip welding flux, do after-working on casted material, or even want to open up the asphalted street, we will supply the right hammer.

Vibration-reduced

Apart from noise generated by hand held pneumatic air tools, the inherent vibrations are a health risk for everyone who has to work with such tools over a longer period of time. People who work with pneumatic hammers on a daily basis are subject to the so called "white finger disease". Painful inflammation can be the result and under special circumstances, such as hard knocks hairline cracks in the bone mass can appear.

Passive measures to reduce vibration such as special gloves have not provided the desired success. Red Rooster has reduced the vibration through design measures to an acceptable level.

Hammers

Chippers & clay diggers



Type	Brand	Shank size mm	Bore diameter mm	Stroke mm	Blows p/min	J/Blow	Air cons. l/sec	Weight kg	Inlet-thread	Hose diameter mm	Vibration m/s ²	Noise Level dB(A)
TFC-200F	TOKU	□ 12.7	20	10	12.000	-	4.1	1.55	PT 1/4"	10	14.3	91
TFC-257L	TOKU	□ 12.7	20	10	12.000	-	4.1	1.55	PT 1/4"	10	14	92
F-25	YOKOTA	□ 12.3 x 16 x 28	25	22	4.000	-	6.0	1.8	PT 1/4"	10	12	91
RR-0315	RRA	□ 12.3 x 16 x 28	25	32	4.000	-	3.0	2.6	PT 1/4"	10	9.4	93
BRH-6	YOKOTA	○ 10.2 x 40	20	60	3.500	2.2	6.6	1.4	PT 1/4"	10	17	95
RRH-4210	RRA	○ 10.2 x 40	19	50	3.500	2.0	4.0	1.5	PT 1/4"	10	8	90
RRH-4210K	RRA	◇ 10.5 x ○ 12.5 x 50	19	50	3.500	2.0	4.0	1.5	PT 1/4"	10	8	90
RRI-4021/3	RRI	◇ 10.5 x ○ 12.5 x 50	18	30	4.500	1.5	5.0	2.2	PT 1/2"	10	3.5	88
AA-OB*	TOKU	◇ 12.7 x ○ 15 x 55	20	50	3.600	7.0	5.8	2.6	PT 3/8"	10	12	89
AA-1.3B**	TOKU	◇ 14.8 x ○ 17.3 x 60	24	58	2.800	11.7	7.5	4.5	PT 3/8"	10	10	93
AA-3B**	TOKU	◇ 14.8 x ○ 17.3 x 60	28.5	79	2.400	21.6	11.7	5.8	PT 3/8"	13	10	94
THH-2B H	TOKU	◇ 14.8 x ○ 17.3 x 60	28.5	51	2.300	14.5	14.2	6.1	PT 3/8"	13	11.6	93
THH-3B H	TOKU	◇ 14.8 x ○ 17.3 x 60	28.5	64	2.200	18.3	15.0	6.4	PT 3/8"	13	8	93
THH-4B H	TOKU	◇ 14.8 x ○ 17.3 x 60	28.5	102	1.800	29.1	15.8	8.1	PT 3/8"	13	11.6	92
RRI-4596/1	RRI	◇ 22 x 82	34	114	1.590	30.0	15.0	10.6	PT 3/4"	13	16	101
RRI-4596 R	RRI	○ 25 x 75	34	114	1.590	30.0	15.0	10.6	PT 3/4"	13	16	101
TCD-20	TOKU	◇ 22 x 82	43	60	2.000	38.7	18.0	11.3	PT 1/2"	13	16	105

* Shank size ◇ 11.0 x ○ 12.7 x 45 on request

** Shank size ◇ 14.8 x ○ 17.5 x 60 on request

Type	A	B	C	D	Type	A	B	C	Type	A	B	Type	A	B
TFC-200F	51	23	21	9.5	F-25	16	12.3	28	BRH-6	40	10.2	RRH 4210	40	10.2
					RR-0315	16	12.3	28	RRI-4596R	75	25			
					TFC-257L	13	12.7	27						

Breakers & rock drills

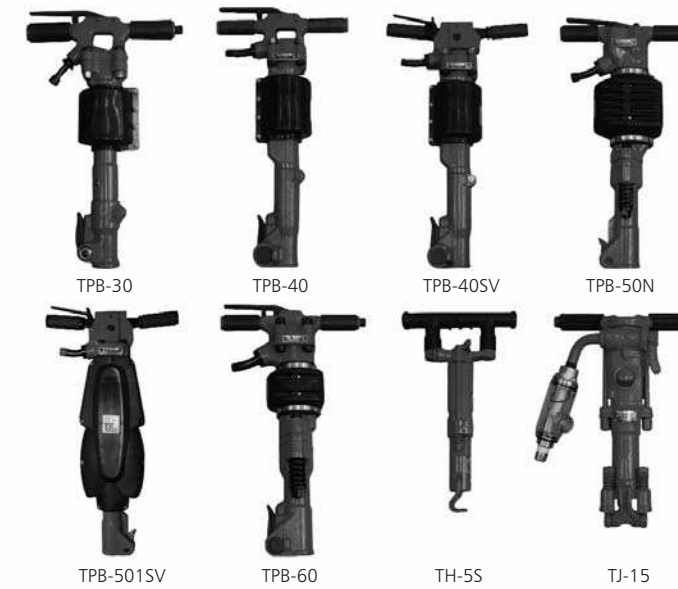

Paving breakers

Type	Brand	Shank size mm	Bore diameter mm	Stroke mm	Blows p/min	J/Blow	Air cons. l/sec	Weight kg	Inlet-thread	Hose diameter mm	Vibration m/s ²	Noise Level dB(A)
TPB-30	TOKU	◇ 25 x 108	44.5	85	1.550	59	23	15	PT 1/2"	13	11.7	107
TPB-40	TOKU	◇ 25 x 108	44	146	900	98	26	19	PT 3/4"	19	19	106
TPB-40SV	TOKU	◇ 25 x 108	40	143	1.050	98	20	20	PT 3/4"	19	5.5	108
TPB-50N	TOKU	◇ 32 x 160	50	156	1.050	137	23	22	PT 3/4"	19	17.2	107
TPB-501SV	TOKU	◇ 32 x 160	50	156	1.250	137	25	23	PT 3/4"	19	14	107
TPB-60	TOKU	◇ 32 x 160	57	127	1.400	115	27	32	PT 3/4"	19	9.7	111

Rock drills

Type	Brand	Shank size mm	Bore diameter mm	Stroke mm	Blows p/min	Rotations p/min	J/Blow	Air cons. l/sec	Weight kg	Inlet-thread	Hose diameter mm	Vibration m/s ²	Noise Level dB(A)
TH-5S	TOKU	○ 19 x ◇ 14.8 x 89	38	31	3.400	420	15.6	14	5.8	PT 3/8"	13	-	-
TJ-15LBS	TOKU	◇ 22 x 108	54	45	2.450	250	41	26	14	PT 3/4"	19	-	-
TJ-15SBS	TOKU	◇ 22 x 82	54	45	2.450	250	41	26	14	PT 3/4"	19	-	-

Type	A	B	C	Type	A	B	C	Type	A	B	Type	A	B	C
RRH-4210K	50	12.5	10.5	AA-OB	55	15	12.7	RRI-4596/1	82	22	TH-5S	89	14.8	19
RRI-4021/3	50	12.5	10.5	AA-1.3B	60	17.3	14.8	TCD-20	82	22				
				AA-3B	60	17.3	14.8	TPB-30/40/40SV	108	25				
				THH-2B H	60	17.3	14.8	TPB-50N/501SV	160	32				
				THH-3B H	60	17.3	14.8	TPB-60	160	32				
				THH-4B H	60	17.3	14.8	TJ-15LBS/SBS	108/82	22				

Hammers

Models

Straight model

F-25
RR-0315
TFC-200F



Straight model
F-25

Pistol model

BRH-6
RRH-4210
RRH-4210K



Pistol model
RRH-4210

Open handle

RRI-4021/3
AA-OB
THH-2B H
THH-3B H
THH-4B H



Open handle
AA-OB

Closed handle

AA-1.3B
AA-3B
RRI-4596



Closed handle
AA-1.3B

T-grip

TPB-30
TPB-40
TPB-40SV
TPB-50N
TPB-501SV
TPB-60
TJ-15
TH-5S



T-Grip
TPB-501SV

Chisels page 188 and onwards.

Model RRI-4021/3 is vibration reduced
Vibration level 3.5 m/s²



Dimensions / Accessories

Dimensions

Type	A mm	B mm
AA-OB	245	-
AA-1.3B	300	76
AA-3B	300	87
BRH-6	200	149
F-25	310	43
RRH-4210	217	131
RRH-4210K	217	131
RRI-4021/3	255	-
RRI-4596	480	118
TFC-200F	189	40
THH-2B H	350	-
THH-3B H	422	-
THH-4B H	430	-
TCD-20	520	-
TPB-30	564	-
TPB-40	660	-
TPB-40SV	649	-
TPB-50N	642	-
TPB-501SV	714	-
TPB-60	645	-
TJ-15	468	-
TH-5S	425	-

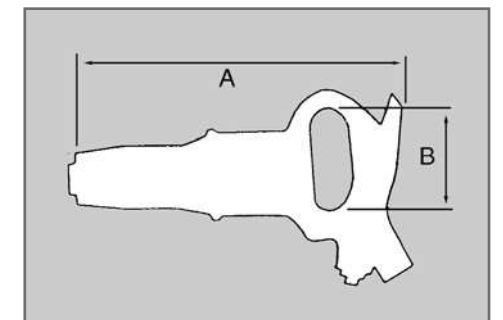
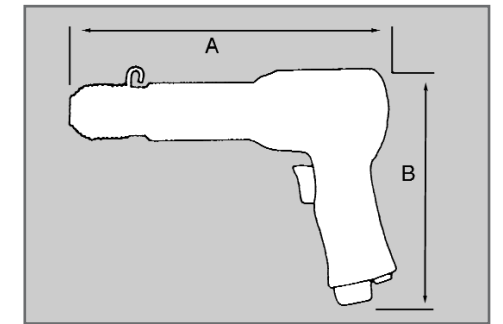
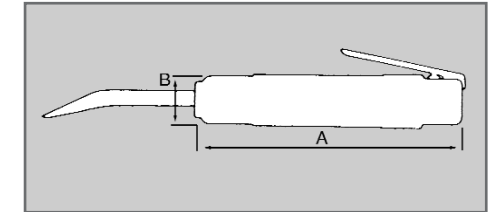

Accessories

Quickchange chisel retainer

BRH-6	PT-2311
RRH-4210	PT-2311

Chisel retainer

RRI-4021/3	4221-310-01	*
THH-2B H	60513	*
THH-3B H	60513	*
THH-4B H	60513	*

Rubber ring for chisel retainer

RRI-4021/3	4221-321-00	*
------------	-------------	---

Chisel retainer spring

THH-2B H	60511	*
THH-3B H	60511	*
THH-4B H	60511	*

Open spring

BRH-6	6101-0822-00-03	*
RRH-4210	2309	*
AA-OB	60029	*
AA-1.3B	63112	*
AA-3B	63112	*

Closed spring

BRH-6	6101-0822-00-01	*
AA-OB	60029-A	*
AA-1.3B	63112-A	*
AA-3B	63112-A	*

Spring and rubber ring

AA-OB	60029-R
AA-1.3B	63112-R
AA-3B	

Rubber ring

AA-OB	60040
AA-1.3B	63112-RU
AA-3B	63112-RU

* Supplied as standard.

9. Needle scalers

Applications



Surface treatment

The needle scalers can be used to remove rust, old paint-layers or concrete from surfaces. Also the removal of welding flux from the welding seam is made easy by using the appropriate needle scaler. A wide range of shapes and sizes is available.

RSI

Repetitive strain injury, repetitive stress injury, or RSI is a term that most people have heard of. RSI is really a blanket name that is used to describe many different types of soft tissue injury including carpal tunnel syndrome and tendonitis. A mixture of bad ergonomics, poor posture, stress, and repetitive motion usually causes it.

If you work with needle scalers on a daily basis you are certainly at risk from repetitive strain injury. It may not be life threatening, but RSI has the potential to cause crippling disability and pain. Early treatment is the key to success, because recovery can be a very slow process. Better of course is prevention.

How to avoid RSI?

- A well-balanced power to weight ratio
- Vibration reduced to a minimum
- A rubber handgrip will dampen some of the vibrations and gives the operator a smooth and good grip.

Needle scalars

Straight - / Pistol models



Type	Brand	Bore diameter mm	Stroke mm	Blows p/min	Air cons. l/sec	Weight kg	Inlet-thread	Hose diameter mm	Vibration m/s ²	Noise Level dB(A)
YK-2*	YOKOTA	24.0	33.0	8.000	6.0	2.5	PT 3/8"	13	5.6	85
TFC-N200	TOKU	20.0	10.0	12.000	4.1	1.12	PT 1/4"	10	14.3	91
F-25N	YOKOTA	25.0	22.0	4.000	6.0	2.3	PT 1/4"	10	10.0	78
RR-0315 NS	RRA	25.0	32.0	4.000	3.0	2.6	PT 1/4"	10	9.4	93
RR-2110 NS	RRA	23.5	33.0	3.000	3.0	2.5	PT 1/4"	10	20.0	96
RRI-4006	RRI	23.5	34.0	3.000	2.6	2.6	PT 1/4"	10	17.0	90
RRI-4007 VL**	RRI	34.4	30.5	3.000	2.6	3.4	PT 1/4"	10	1.9	95
RRI-4007	RRI	30.5	30.5	2.500	3.3	4.3	PT 1/4"	10	12.0	91
RRI-4008	RRI	33.0	35.5	2.100	4.8	5.9	PT 1/4"	13	13.0	90

* Scaler / scabler

** Vibration reduced

F-25N, TFC-N200 and RR-0315 NS are straight -, the others are pistol models.

All needle scalars are supplied as standard with 3 mm needles.

Needles for type	Number 2 mm	Number 3 mm	Number 4 mm
TFC-N200	21	12	-
F-25N	-	19	-
RR-0315 NS	-	19	-
RR-2110 NS	-	19	-
RRI-4006	51	19	-
RRI-4007 VL	65	28	19
RRI-4007	65	28	19
RRI-4008	-	49	35

Dimensions / Needleholders and needles

Dimensions

Type	A mm	B mm
YK-2	489	126
F-25N	412	43
RR-0315 NS	415	45
RR-2110 NS	340	175
RRI-4006	330	48
RRI-4007	460	57
RRI-4007 VL	330	48
RRI-4008	475	66
TFC-N200	273	36

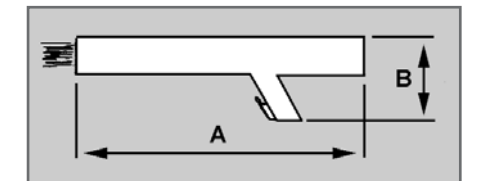
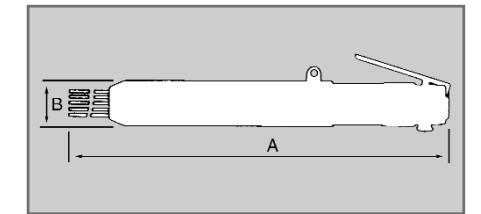
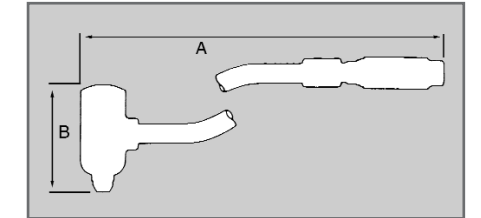

Needleholders

For type	2 mm	3 mm	4 mm
TFC-N200	Y30612220	Y30612220	-
F-25N	-	6203-0829-02-00	-
RR-0315NS	-	SG0315NS-25	-
RR-2110NS	SG-2110NS-24	SG-2110NS-17	-
RRI-4006	218	217	-
RRI-4007VL	601.3020	601.3030	601.3040
RRI-4007	330	314	353
RRI-4008	-	414	453

Needles

For type	Order number	Diameter	Model
RRI-4006	6203-0827-02-01	2 mm	Blunt, hardened steel
RRI-4007 (VL)			
TFC-N200	Y30612210	3 mm	
	Y3061004B	2 mm	
For all needle scalars	6203-0827-03-01	* 3 mm	Blunt, hardened steel
	6203-0827-03-02	3 mm	Chisel point, hardened steel
F-25N	6203-0827-03-03	3 mm	Copper-beryllium
RR-0315 NS	6203-0827-03-04	3mm	Stainless steel, flat
RRI-4007 (VL)	6203-0827-04-01	4 mm	Blunt, hardened steel
RRI-4008			

* Supplied as standard.



YK-2

10. Power cutters

Applications



Cutting and pressing

Power cutters have simplified cutting and pressing in mass production. Versatile applications of the power cutter by selection of suitable blades, make it possible to increase production. The working pressure is 4 - 5 bar. Blades for power cutters are delivered separately.

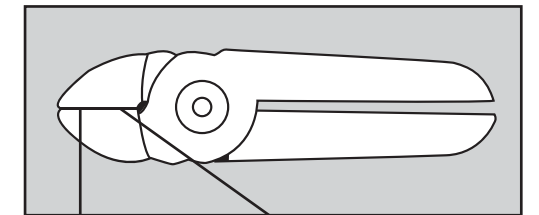

Note: Only cut your piece of work in this area of the blade. Do not twist the tool when cutting!

Cutting here will cause damage to the blade!

Power cutters

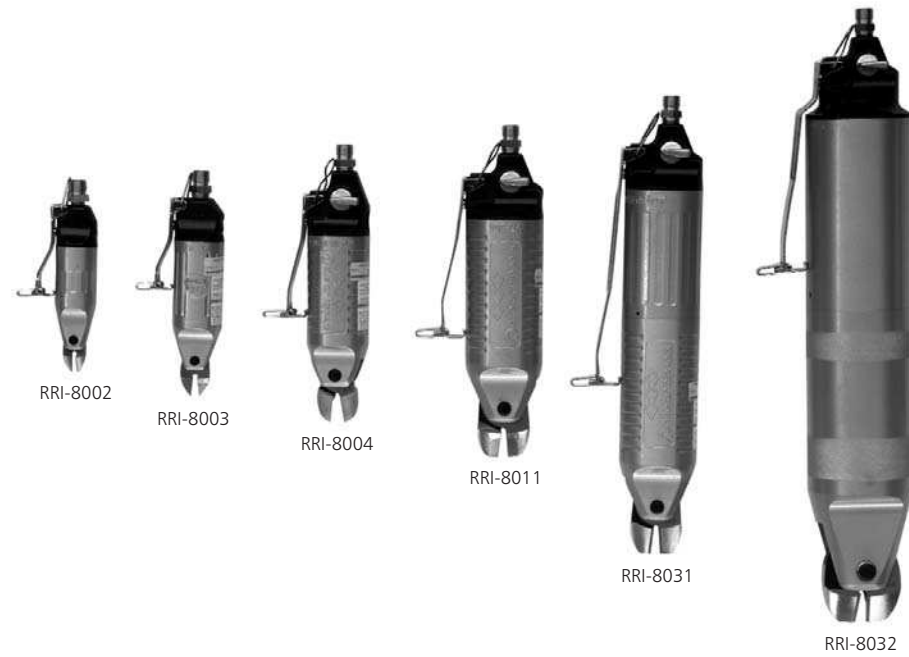

Dimensions / Blades

Dimensions

Type	A mm	B mm
RRI-8002	30	104
RRI-8003	36	124
RRI-8004	45	156
RRI-8011	56	192
RRI-8031	56	280
RRI-8032	75	390

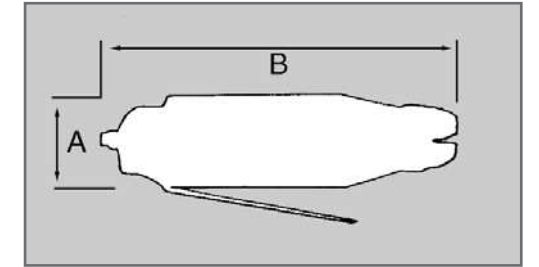

Type	Brand	Capacity copper mm	Capacity steel* mm	Capacity plastics mm	Capacity crimping mm	Power midway on blade kg	Air cons. l/stroke	Weight kg**	Inlet-thread	Hose diameter mm	Vibration m/s ²	Noise Level dB(A)
RRI-8002	RRI	1.0	0.5	-	-	40	0.064	0.13	PT 1/4"	6	0.2	71
RRI-8003	RRI	1.6	1.0	4.0	-	60	0.116	0.20	PT 1/4"	6	0.4	72
RRI-8004	RRI	2.6	2.0	7.0	-	140	0.23	0.34	PT 1/4"	6	0.3	73
RRI-8011	RRI	3.3	2.8	10.0	2.0	280	0.584	0.52	PT 1/4"	6	1.0	76
RRI-8031	RRI	4.8	4.0	13.0	5.5	450	0.956	0.83	PT 1/4"	6	1.0	75
RRI-8032	RRI	7.0	6.0	-	-	790	2.7	2.0	PT 1/4"	6	1.5	78

* Steel FE 370
** Without blades

Blades - cutting capacity

Type	Copper mm	Steel FE 370 mm	Piano wire mm	Plastics mm	Crimping mm	Blade type
RRI-8002	1.0	0.5	-	-	-	S-2
	1.0	0.5	0.3	-	-	G-2
	-	-	-	0.2	-	F-1
RRI-8003	1.6	1.0	-	-	-	S-4
	1.6	1.0	0.5	-	-	Z-4
	-	-	-	4.0	-	F-3
RRI-8004	2.6	2.0	-	-	-	P-6, CR-6, EP-6, S-5
	2.6	2.0	1.0	-	-	Z-6 (carbide tip)
	-	-	-	7.0	-	F-5, FD-5
	-	-	-	-	-	-
RRI-8011	3.3	2.8	-	-	-	P-8P, CR-8P
	3.3	2.8	1.2	-	-	Z-8P (carbide tip)
	-	-	-	10.0	-	F-9P, FD-9P
	-	-	-	-	2.0	A-8P
RRI-8031	4.8	4.0	-	-	-	P-8P, CR-8P
	-	-	-	13.0	-	F-9P, FD-9P
	-	-	-	-	5.5	A-8P
	-	-	-	-	-	SH-8P0
RRI-8032	7.0	6.0	-	-	-	P-120, CR-120

Power cutters are supplied without blade, please order separately from the list above.

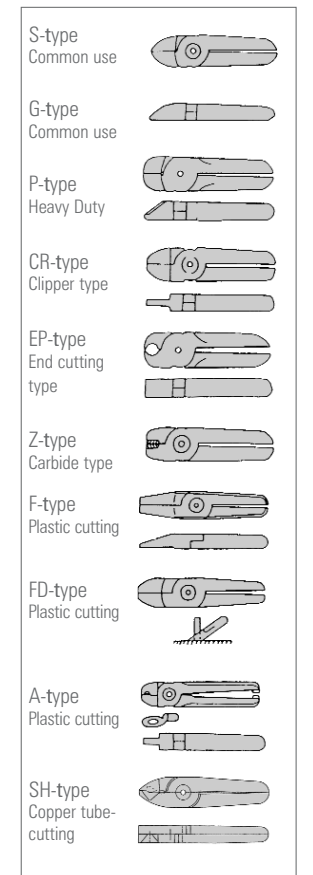
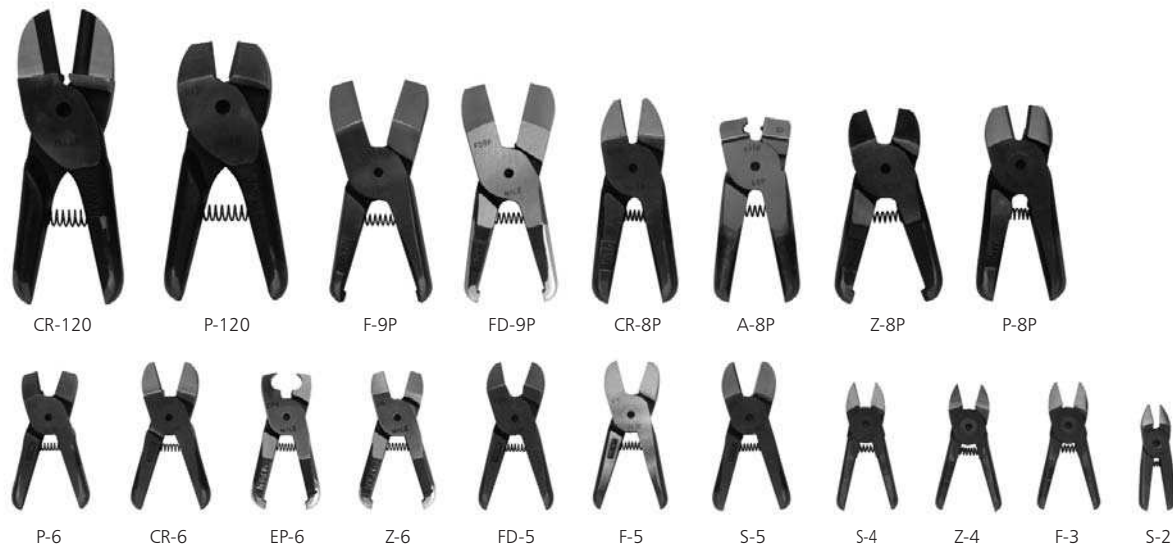

II. Saws

Applications



In our program you will find five saws for four different applications:

Red Rooster jig saw RRI-8100

Suitable for wood working and light metals. Type RRI-8100 is executed with the SDS-Clic System. This saw is often used for coach-work building

Red Rooster reciprocating saws RRI-8205 and RRI-8210

Especially suitable for coach work. Also for other materials like aluminium, plastics, wood, steel, etc. Both models are vibration reduced.



Red Rooster pipe saw RRI-8460

This saw can be used for pipe sawing up to a diameter of 530 mm The saw has noise reduction and is suitable for all standard available saw blades. Clamps are optional.

Red Rooster chain saw RRI-8550

The chain saw is for use on general timber cutting and is supplied with the Sandvik blade and chains.

Saws

Jig saw / Reciprocating saws



RRI-8100



RRI-8205



RRI-8210

Jig saws

Type	Brand	Capacity metal mm	Capacity plastics mm	Capacity wood mm	Strokes p/min	Stroke mm	Power kW	Air cons. l/sec	Weight kg	Inlet-thread	Hose diameter mm	Vibration m/s ²	Noise Level dB(A)
RRI-8100*	RRI	10	20	60	2.400	2.6	0.4	11.3	1.5	PT 1/4"	10	2	80

* Executed with the SDS-clic system.

Reciprocating saws

Type	Brand	Capacity steel mm	Capacity aluminium mm	Strokes p/min	Stroke mm	Power kW	Air cons. l/sec	Weight kg	Inlet-thread	Hose diameter mm	Vibration m/s ²	Noise Level dB(A)
RRI-8205*	RRA	10	12	5.000	25	0.2	3.0	0.96	PT 1/4"	10	9	85
RRI-8210*	RRA	3.1	3.9	9.500	10	0.2	3.0	0.51	PT 1/4"	10	9	85

* Standard supplied in set. Sawblades and universal air inlet joint are supplied as standard. Accessories for saws on page 94.

Chain saw / Pipe saw

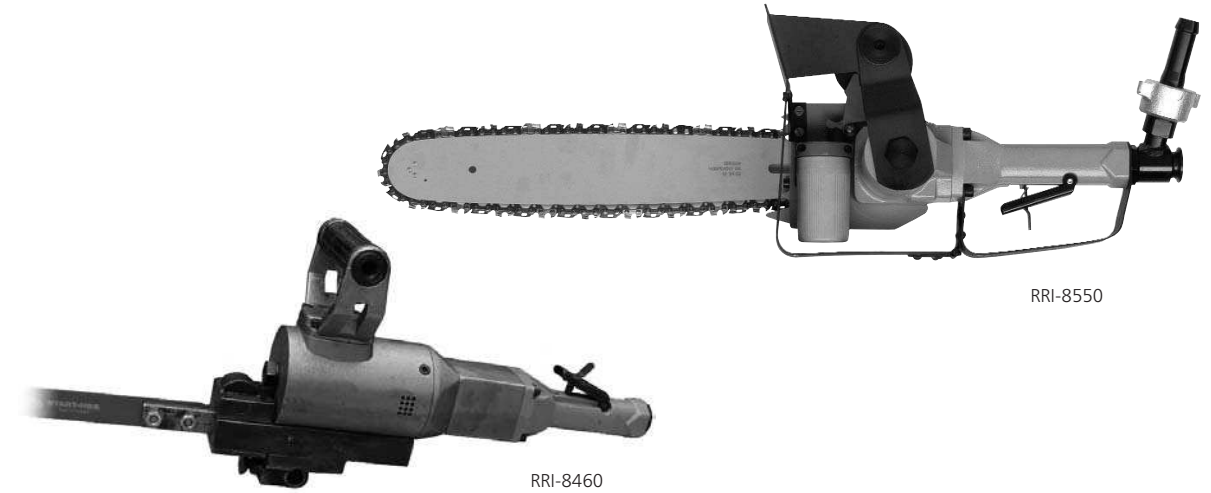

RRI-8550

RRI-8460

Chain saw

Type	Brand	Length sawblade Zoll	Rotations p/min	Power kW	Air cons. l/sec	Weight kg	Inlet-thread	Hose diameter mm	Vibration m/s ²	Noise Level dB(A)
RRI-8550	RRI	14"	11.400	1.1	20	5	BSP 3/4"	13	6	92

Pipe saw

Type	Brand	Capacity metal Ø mm	Strokes p/min	Stroke mm	Power kW	Air cons. l/sec	Weight kg	Inlet-thread	Hose diameter mm	Vibration m/s ²	Noise Level dB(A)
RRI-8460	RRI	45-530	300	65	1.1	20	8.0	BSP 3/4"	19	6	81

Accessories for saws on page 94.

Saws

Accessories



For RRI-8100

5-pack sawblades	8100-100-00	Chipboard, fiber plate, hard and soft wood - 50 mm., soft synthetic materials up to 15 mm, straight saw cut.
5-pack sawblades	8100-110-00	St37, non-iron plate, aluminium - 4 mm, stainless steel - 2mm., marble, fiber glass, reinforced plastics up to 2 mm
5-pack sawblades	8100-120-00	Hard- and soft wood - 60 mm., polyamide, polystyrene, soft synthetics up to 50 mm, rough saw cut.



For RRI-8205 & RRI-8210

Hex wrench	13-40-01-001	*	2 mm
Hex wrench	13-40-01-003	*	3 mm
Sawblade	13-41-03-011	14 teeth/inch ST37, V2A, wood, plastics, metal plate up to 2.5 mm	
Sawblade	13-41-03-010	32 teeth/inch St37, V2A, non-ferro, metal plate up to 1 mm	
5-pack sawblades	8150-532-00	32 teeth/inch, St37, V2A, Aluminium, metal plate up to 1 mm	
5-pack sawblades	8150-524-00	24 teeth/inch St37, V2A, Aluminium, metal plate up to 2 mm	
5-pack sawblades	8150-518-00	18 teeth/inch, St37, V2A, wood, plastics, metal plate up to 2.5 mm	
5-pack sawblades	8150-514-00	14 teeth/inch, wood, plastics, metal plate up to 2.5 mm	



For RRI-8460

Pipe clamp	8460-200-100	6"	
	8460-201-100	12"	
	8460-205-100	20"	
Profile clamp	99417	300 x 35 x 2.0	4 teeth/inch
	99418	300 x 35 x 2.0	6 teeth/inch
	99420	400 x 35 x 2.0	6 teeth/inch
	HSS-sawblades	Z22-10	200 x 25 x 1.5
	Z22-6	300 x 25 x 1.5	16 teeth/inch
	Z22-7	400 x 25 x 1.5	16 teeth/inch
	Z22-72	500 x 28 x 2.0	14 teeth/inch
	Z22-73	600 x 28 x 2.0	14 teeth/inch
	Z22-75	770 x 28 x 2.0	12 teeth/inch
	Z22-31	300 x 25 x 1.5	12 teeth/inch
	Z22-30	530 x 28 x 1.5	12 teeth/inch
	Z22-9	200 x 25 x 1.5	8 teeth/inch
	Z22-29	400 x 25 x 1.5	8 teeth/inch
	ZA91150	530 x 28 x 1.5	4 teeth/inch
	Z22-74	600 x 28 x 2.0	8 teeth/inch
	Z22CT-06	300 x 25 x 2.0	Carbide teeth
HSS-sawblades, heavy duty, long	Z22-37	940 x 32 x 2.0	12 teeth/inch



For RRI-8550

Sawblade	V014 PKU 50 SSR	*	Sandvik
Chain	V050 RG 52	*	Sandvik

Dimensions

Type	A mm	B mm	C mm	D mm
RRI-8100	202	224	-	-
RRI-8205	367	65	-	-
RRI-8210	365	80	-	-
RRI-8460	460	537	240	-
RRI-8550	185	650	20	200

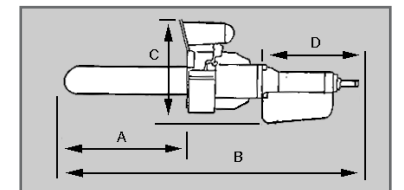
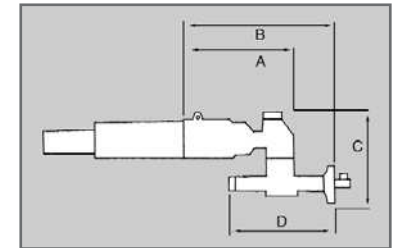
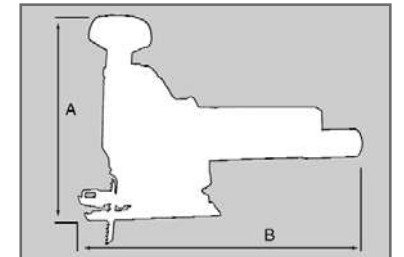
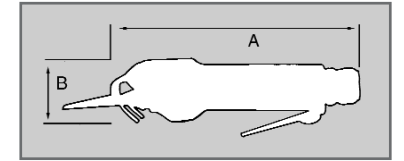

* Supplied as standard.

12. Special tools

For the (assembly) industry



Tip dressers

Everybody knows of the problems with worn tips when working with spotwelding machines. They produce either poor welds or no welds at all. It reflects the quality and productivity of your work. Of course you can replace the tips for new ones, but it might be a better idea to recondition the worn tips by means of Yokota tip dressers.

Dressing can either be done by the operator by hand (YNR-type) or the tip dressers are integrated into the cycles of a spotwelding robot and programmed according to your own needs and wishes (TDN-type). The Yokota tip dressers do not only clean the surface, but also the original shape and edges of the tips are restored.

Hog ringers

The Yokota hog ringers are used for the assembly of car-seats, chairs, beds, fencing, etc. This tool is used to fix the cushion material or the leather material on the seat-frame with hog rings.

Special tools

For the (assembly) industry

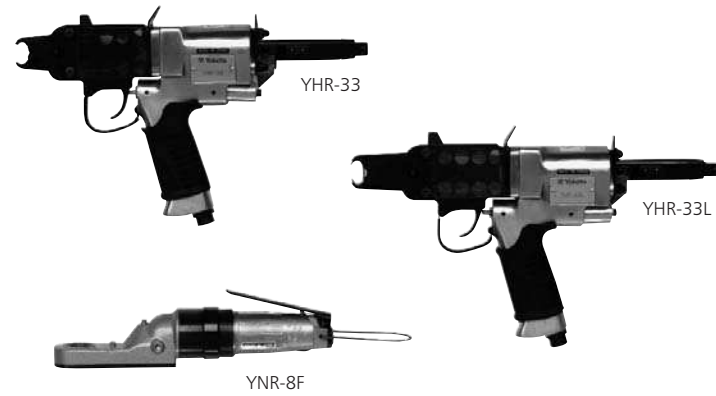

Tip dressers

Type	Brand	Tip capacity mm	Rotations p/min	Rotation L / R	Max. jaw capacity kg	Air cons. l/sec	Weight kg	Inlet-thread	Hose diameter mm	Vibration m/s ²	Noise Level dB(A)
YNR-8F*	YOKOTA	16	1.400	Right	-	6.7	1.2	PT 1/4"	9.5	-	-
TDN-5D	YOKOTA	24	320	Right	50	11.7	2.9	PT 3/8"	9.5	-	83
TDN-6	YOKOTA	24	320	L + R	170 / 650	15.8	6.5	PT 3/8"	13.0	-	84

Hog ringers

Type	Brand	Max. number of rings	Ring size mm	Trigger-pressure kg	Stroke trigger mm	Air cons. l/sec	Weight kg	Inlet-thread	Hose diameter mm	Vibration m/s ²	Noise Level dB(A)
YHR-33	YOKOTA	120	8.0	0.6	7	0.8	1.5	PT 1/4"	6	1.66	79
YHR-33L**	YOKOTA	120	8.0	0.6	7	0.8	1.5	PT 1/4"	6	1.66	79

* Hand model

** Extended nose

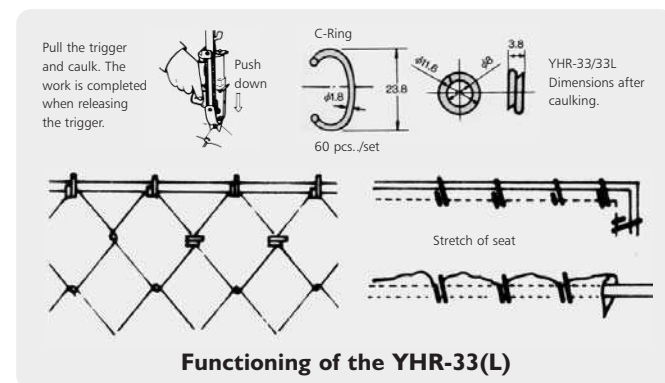

Blades for tip dressers are separately available and will be custom made on tip specifications. On request we can supply you with detailed information.

Other special tailor-made tools on request. Some examples on the next page.

Dimensions / Tailor-made tools

Dimensions

Type	A mm	B mm	B* mm	C mm
YNR-8F	257	19.5	-	24
TDN-5D	162	190	171	19
TDN-6	217	161	142	19
YHR-33	346	188	-	-
YHR-33L	361	188	-	-

Tailor-made tools

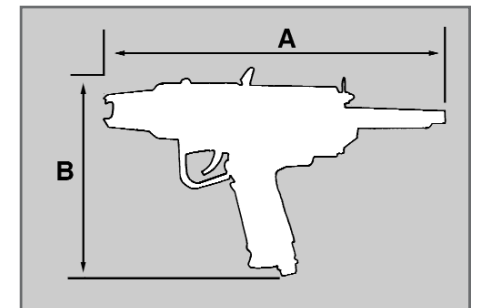
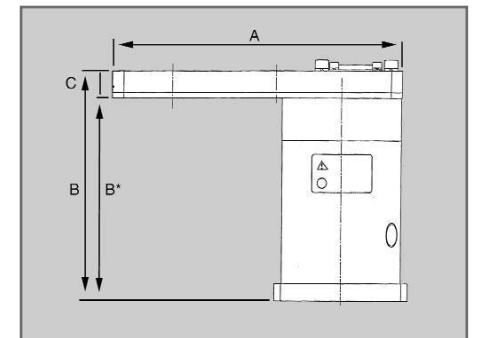
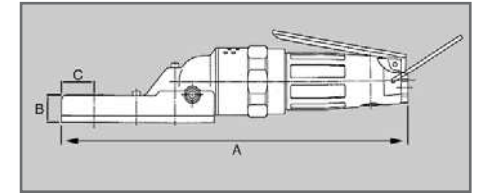
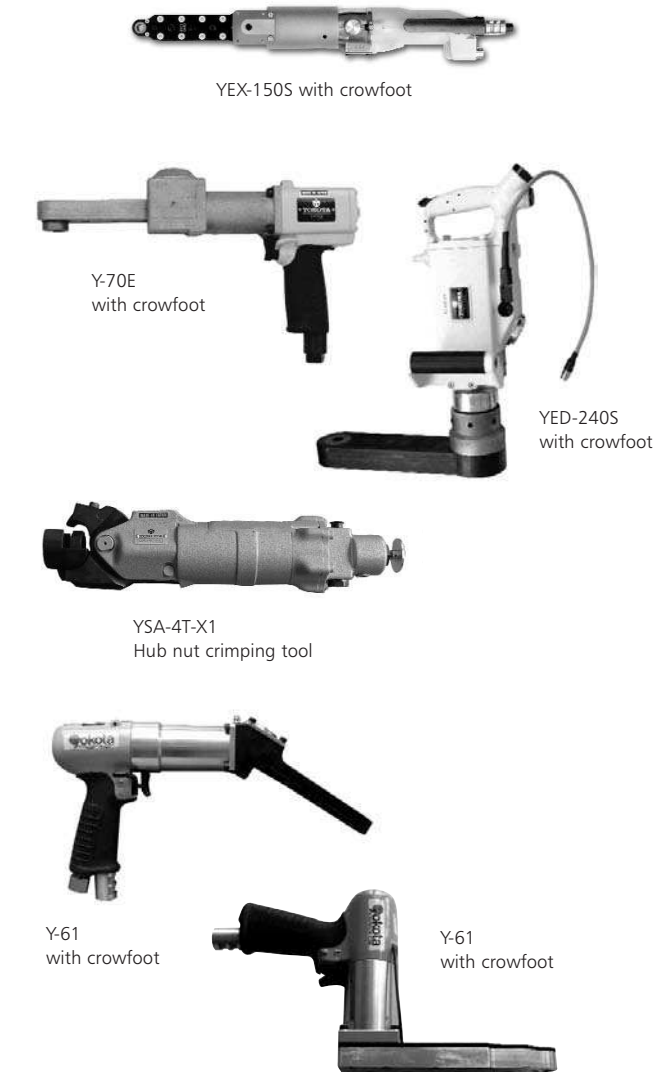

Please inform us about your specific application needs, so we can make you a suitable proposal.



13. Various tools

For several applications



For every workshop

These airtools should be available in every workshop. The engraving pen helps you to mark your (hand-)tools and produce type. Blow guns can be supplied in a simple Red Rooster variant or in a SMC model which will save you air... and thus money.

Riveters

The Red Rooster riveters work with the most usual sizes of rivets. If the current handtools for the rivets are a burden to your employees, use the Red Rooster air-riveter.

Multi-cutter

The Red Rooster multi-cutter RR-476 is a true multi-talent. Sawing, sanding and cutting with only one tool.

Pumps

The Yokota YP pumps are high-quality sump pumps for use on board of ships. The pumps are made of bronze and especially suitable to use in acid environments.

The Yokota barrelpump YPP-1 is developed to pump liquids from barrels, such as fuel, oil, water or chemicals.

Various tools

For several applications



Riveters

Type	Brand	Traction kg	Capacity rivets diameter	Air cons. l/stroke	Weight kg	Inlet-thread	Hose diameter mm	Vibration m/s ²	Noise Level dB(A)
RRI-4010	RRI	900	bis 4,8	1.15	1.5	PT 1/4"	6	1.5	76
RRI-4011	RRI	1045	bis 6,4	1.80	2.0	PT 1/4"	6	0.4	76

Engraving pen

Type	Brand	Needles diameter mm	Strokes p/min	Air cons. l/sec	Weight kg	Inlet-thread	Hose diameter mm	Vibration m/s ²	Noise Level dB(A)
RRI-9010	RRI	1.7	36.000	0.5	0.25	BSP 1/4"	4	0.7	62

Caulking gun

Type	Brand	Tube Ø x mm	Working pressure bar	Air cons. l/sec	Weight kg	Inlet-thread	Hose diameter mm	Vibration m/s ²	Noise Level dB(A)
RRP-203	RRA	50 x 215	2 - 4	-	1.1	PT 1/4"	6.5	-	-

Multi-cutter

Type	Brand	Sawing capacity mm	Movements p/min	Air cons. l/sec	Weight kg	Inlet-thread	Hose diameter mm	Vibration m/s ²	Noise Level dB(A)
RR-476	RRA	1	0 - 22.000	6.5	1.1	PT 1/4"	6.5	2.6	90

Blow guns

Type	Brand	Air cons. l/sec	Weight kg	Inlet-thread	Hose diameter mm	Vibration m/s ²	Noise Level dB(A)
RRI-21930	RRI	5	0.2	PT 1/4"	6.5	-	-
VMG	SMC	1 - 6 *	0.2	PT 1/4"	6.5	-	-

* Depending on nozzle size, to be ordered separately. See next page.

Dimensions / Accessories

Dimensions

Type	A mm	B mm
RRI-4010	159	299
RRI-4011	198	315
RRI-9010	160	-
RRP-203	268	135
RRI-21930	80	250
RR-476	195	79
VMG	140	164

Accessories

For type	Accessory	Order number	
RRI-4010	Nose piece 3.2 mm	10416-1	*
	Nose piece 4.0 mm	10416-2	*
	Nose piece 4.8 mm	10416-3	*
	Bottle for spent rivets	10448	*
	Wrench	10447	*
RRI-4011	Nose piece 3.2 mm	14464	*
	Nose piece 4.0 mm	14465	*
	Nose piece 4.8 mm	14466	*
	Nose piece 6.4 mm	14468	*
	Rivet deflector	14470	*
	Rivet collector (cloth)	612903	
	Set key	14499	*
RRI-9010	Engraving needle, fine	2-01-011-90	
	Engraving needle, medium	2-01-011-91	*
	Engraving needle, coarse	2-01-011-92	
VMG	Nozzle diameter 1 mm	KN-R02-100	
	Nozzle diameter 1.5 mm	KN-R02-150	
	Nozzle diameter 2 mm	KN-R02-200	
	Nozzle diameter 2.5 mm	KN-R02-250	

RR-476 Accessories on page 104.

* Supplied as standard.

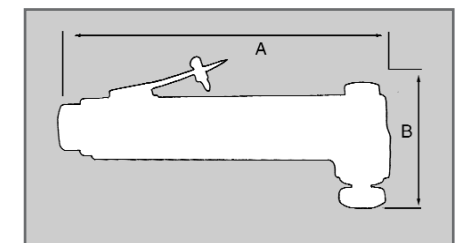
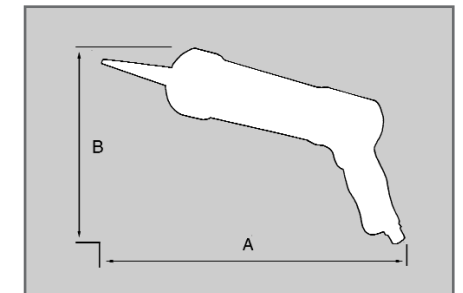
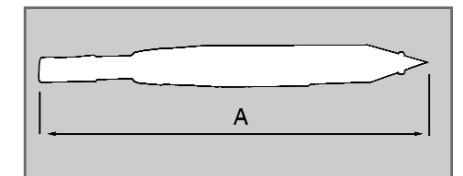
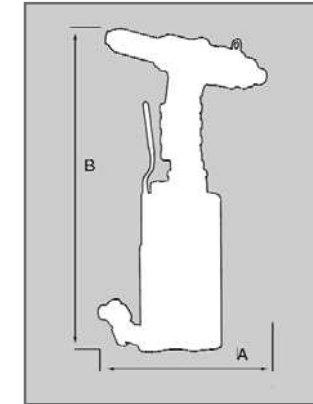

Type RR-476 can be used as saw (with sawblade), for cutting urethane-bonded windows (with various blades) and as a sander (with triangle sanding pad).



Engraving needles fine, medium, coarse.

Various tools

Accessories for RR-476

RR-476	Type	Order number	Dimension
	475G26	639-03-121-018	56/26 mm
	475G35	639-03-073-011	56/35 mm
	475G40	639-03-176-015	74/40 mm

RR-476	Type	Order number	Dimension
	475L16	639-03-122-011	16 mm
	475LR16	639-03-099-010	16 mm
	475L23	639-03-173-010	23 mm
	475L25	639-03-124-013	25 mm
	475L27	639-03-174-018	27 mm
	475L45	639-03-168-018	45 mm
	475LR46	639-03-179-011	46 mm
	475LR54	639-03-160-015	54 mm
	475LR58	639-03-097-018	58 mm
	475L55	639-03-123-015	55/32 mm
	475L80	639-03-171-013	80/70 mm
	475L85	639-03-081-013	85/60 mm
	475L85-1	639-03-125-017	85/70 mm
	475L110	639-03-194-016	110 mm

RR-476	Type	Order number	Dimension
	475VZ14	639-03-120-019	14 mm
	475VZ35	639-03-103-017	35 mm
	475VZ35-1	639-03-104-015	35 mm
	475VZ35-2	639-03-109-018	35 mm
	475VZ35-3	639-03-164-019	35 mm
	475VZ35-4	639-03-172-016	35 mm

RR-476	Type	Order number	Dimension
	475M12	639-03-129-050	12 mm
	475M13	639-03-113-016	13 mm
	475M17	639-03-144-011	17 mm
	475M18-1	639-03-146-018	18 mm
	475M25	639-03-105-019	25 mm
	475M25-1	639-03-131-017	25 mm

RR-476	Type	Order number	Dimension
	M17		
	M13		
	M12		
	M18		
	M25		
	M25-1		
	475N10	639-03-132-010	-

RR-476	Type	Order number	Dimension
	475L16	639-03-122-011	16 mm
	475KR11*	639-03-189-010	11 mm
	475KR14	639-03-082-016	14 mm
	475KR16-1	639-03-133-014	16 mm
	475KR16*	639-03-089-016	16 mm
	475KR16/35	639-03-143-013	16/35 mm
	475KR18/39	639-03-170-014	18/39 mm
	475KR20/35	639-03-189-015	20/35 mm
	475KR32/46	639-03-195-010	32/46 mm
	475KR39	639-03-152-018	39 mm
	475KR42/60	639-03-182-015	42/60 mm
	475K45	639-03-072-17	45 mm
	475KR60/76	639-03-169-012	60/72 mm

RR-476	Type	Order number	Dimension
	475U10	639-03-083-010	10 mm
	475U16	639-03-095-011	16 mm
	475U16-2	639-03-108-014	16 mm
	475U18	639-03-087-019	18 mm
	475U18-1	639-03-127-014	18 mm
	475U19	639-03-118-013	19.5 mm
	475U22	639-03-115-018	22 mm
	475U24	639-03-076-016	24 mm
	475U28	639-03-163-011	28 mm
	475U32-2	639-03-191-011	32 mm
	475U32	639-03-114-014	32 mm
	475U32-1	639-03-147-012	32 mm
	475U36	639-03-079-012	36 mm
	475U40	639-03-110-010	40 mm
	475U40-1	639-03-156-017	40 mm
	475U45	639-03-154-010	45 mm
	475U52	639-03-153-012	52 mm
	475U60	639-03-101-010	60 mm
	475U60-2	639-03-107-016	60 mm
	475U60-3	639-03-157-011	60 mm
	475U70	639-03-155-014	70 mm
	475U95	639-03-111-019	95 mm

RR-476	Type	Order number	Dimension
	475X19	639-03-208-010	19 mm
	475X24	639-03-153-012	24 mm
	475X25	639-03-207-012	25.4 mm

Sawblade	475101	Ø 63 mm - Steel 1 mm
Sawblade	475801	Ø 80 mm - HSS
Scraper	475501	Removing coating
Sanding pad	475380	Grain 80
Sanding pad	4753150	Grain 150
Sanding pad	4753240	Grain 240
Sanding pad	476TP	Triangle

For specifications of the required blades per brand and type car, you can require the special leaflet from our sales department.

Pumps

Sump- and barrelpumps

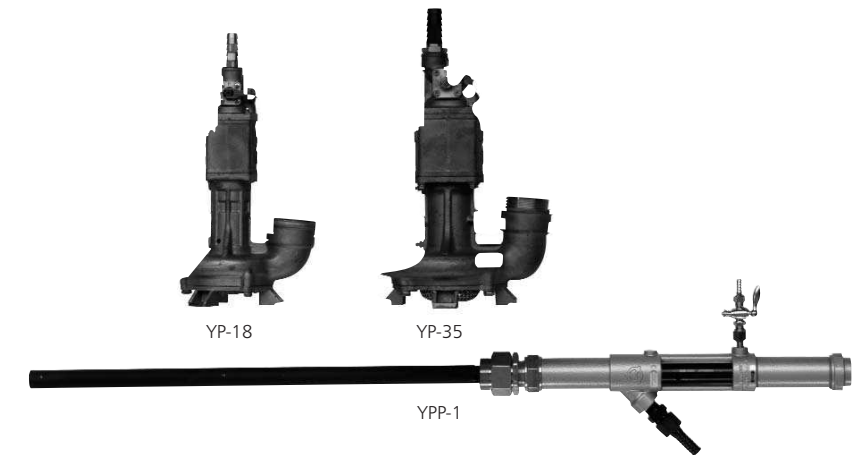

Type	Brand	Description	Max. capacity	Total head m	Air-cons. l/sec	Weight kg	Air hose Ø mm	Outlet hose Ø mm	Air return hose Ø mm
YPP-1*	YOKOTA	Piston pump	65 l/min	40	7.5	8.8	10	19	-
YP-18	YOKOTA	Bronze sump pump	55 t/h	25	33.0	19.0	19	65	25
YP-35	YOKOTA	Bronze sump pump	80 t/h	41	73.0	32.0	25	65	38

* YPP-1: Connection thread PT 1 1/2" / Inlet thread PT 1/4" / Outlet thread PT 3/4".

Option Teflon packings/seals for YPP-1
 7003-1009-11-11 8010-0315-11-11
 7003-1014-11-11 9010-1026-11-11

Dimensions

Type	A mm	B mm	C mm
YPP-1	606	68	-
YP-18	525	189	250
YP-35	550	270	320

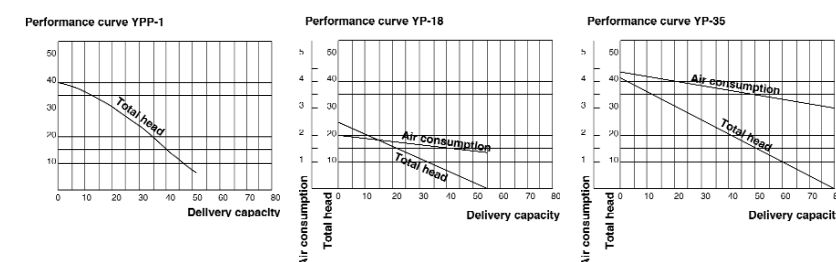
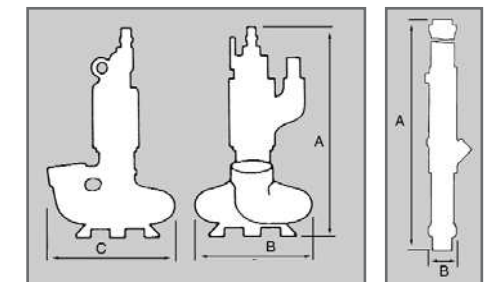

Type YPP-1 has been developed for pumping liquids from drums. The pump fits on standard oil-drums with a normal 1 1/2" pipe thread opening. The models YP-18 and YP-35 are manufactured throughout in bronze and are suitable to pump aggressive liquids, like seawater.

14. Air chain hoists

0.125 - 100 tonnes



Red Rooster

The Red Rooster range of hoists is widely used both On- and Off-shore, throughout the world; typically in marine, shipbuilding, chemical and petrochemical, food, paint and papermaking industries, wherever reliability of performance and safety in use are paramount.

Red Rooster air chain hoists are compact in design and low in headroom. The hoists have infinitely variable speed, and are rated for continuous use. Another advantage of the air hoists is the soft start and stop. Air hoists do not impose shock loading during acceleration and deceleration. The Red Rooster air hoists are of compact construction with cast iron bodies for durability and safety.

Various models

The hoists may be of hook suspension or supplied with the options of manual or pneumatically driven trolleys. Load chain conforms to EN-818-7. All models are supplied with cord (C), which affords the user simple but precise control of the hoist. Additional options are pilot pendant (P) or light weight pendant (for applications in zone 1 areas). Hoists from 0,5 tons and bigger are supplied with built-in load limiter. All hoists are supplied with internal disc brake.

Design F.O.S. 5, proof load 1.5 x W.W.L., internal silencers, explosion proof motor, automatic upper and lower limit switches. Spark resistant air chain hoists are available on request.

Air trolleys

The air trolleys have a good price/quality ratio. The wheels are made of steel or bronze (on request). Constructed with sealed wheel bearings. Adjustable to cover a range of beam flange widths. A worm gear box prevents run on.

Users

Shell UK, BP, Marathon, Mobil, Unocal, ICI, Pfizer, P&O, Triumph, Rockwater, British Coal, Leyland DAF, Thyssen, Repsol, Basf.

Mini hoists

Light, strong and compact



TCR-250



Trolley for mini hoists

If you are looking for a technically advanced, flexible and compact air hoist of industrial quality to work in a variety of applications, you will find the TCR-range mini hoists of light aluminium will meet all your demands.

Advantages

- Well-balanced
- Built-in disc brake system
- Explosion proof motor
- No limit in lifting height
- Precise position-finding afforded by variable lifting/lowering speed
- Available both "hook suspension" and "trolley-mounted"
- Very portable

Type	Capacity t	Lifting speed full load m/min	Lifting speed without load m/min	Air consumption full load l/sec	Weight kg
TCR-125 C/DP	0.125	14.0	19.0	11.7	6.3
TCR-250 C/DP	0.25	9.3	19.0	11.7	6.3
TCR-500/2 C/DP	0.5	4.5	9.5	11.7	8.5
TCS-500 C/P*	0.5	17	33	33.3	15.9

* Chain bag (standard supplied) for 8m chain
- Detailed information on pages 112-113.

For example

The headroom of the TCR-250 is 305 mm. Weighing only 6.3 kg. - including 3 m (10 ft) lift - the hoist will lift 250 kg. at a speed of 9,3 m/min. Available with a cord control (C) or a pendant control with emergency stop (DP). Both have variable speed.



A

TCR-125

Description	Model	Type	Max. m
Chain bag	A	SW-0	12
Chain bag	A	SW-00	20

TCR-250

Description	Model	Type	Max. m
Chain bag	A	SW-0	12
Chain bag	A	SW-00	20

TCR-500/2

Description	Model	Type	Max. m
Chain bag	A	SW-0	6
Chain bag	A	SW-00	10

Compact hoists

For material handling



TMM-140AE

The red rooster compact hoists are excellent for material handling, particularly for production handling to and from bench level of for mating of component parts during assembly. The controls are mounted adjacent to the bottom hook, enabling the operator to precisely control the load whilst raising and lowering, with one hand.

The hoist operates up to two meters lift height (as far as a man can reach in comfort). Where the process requires the load to be raised traversed and then lowered, the hoist may be combined with a trolley on an overhead runway or C track. Top and bottom end limits are included to prevent over-hoisting and over-lowering, whilst an Emergency Stop (red, mushroom head) is located immediately adjacent to the control levers (cutting off the air supply in the event of an emergency).

Type	Capacity t	Lifting speed full load m/min	Lifting speed without load m/min	Air consumption full load l/sec	Weight kg
TMM-140AE	0.14	11.0	15.0	8	9

Detailed information on pages 112-113.

The TMM-140AE has a reversible handgrip for left or right hand operation. The handgrip is rubber covered. The raise and lower operating triggers afford the operator precise, variable speed control.



TMM-140AE

1. Push buttons near the bottom hook
2. The operator can steer the package with one hand
3. Better comfort and safety for the operator

Air chain hoists

0.25 - 6 tonnes

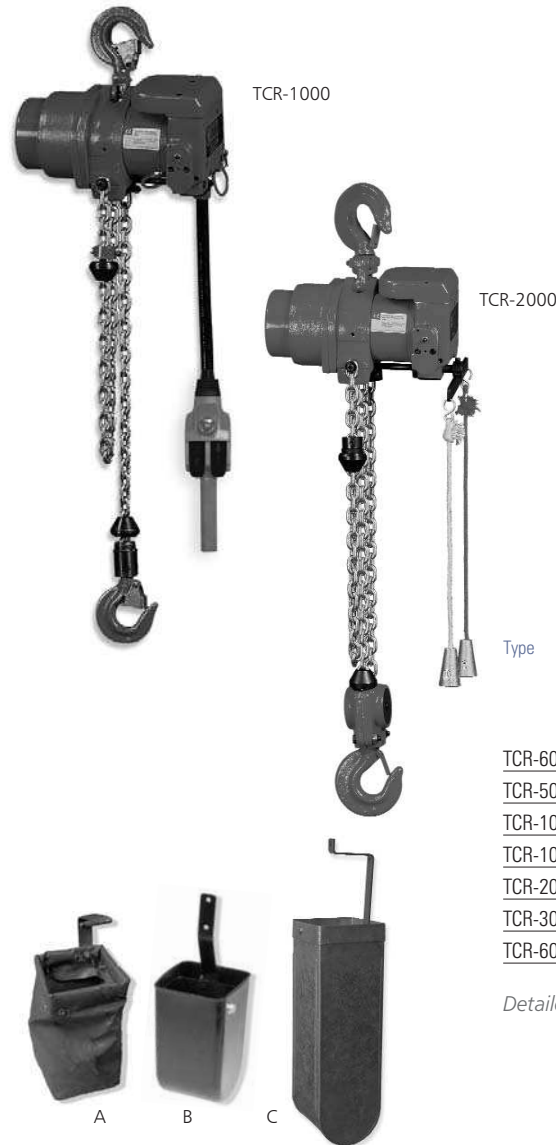

This Red Rooster hoists have a cast steel body and feature proportional speed control via the fail-safe control valve. Mechanical paddle action upper and lower limit switch prevents over hoisting and over lowering, whilst the bottom hook (with safety latch) is mounted on low friction bearings enabling it to rotate under load.

In standard form the hoist may be used in CENELEC Zone 2 hazardous areas (explosive gases), whilst all types are also available in "spark resistant" form for use in CENELEC Zone 1 hazardous areas. Full details of "spark resistant" hoists can be found on page 016 of this catalogue. The hoists are also available in "Clean Area" form for use in the pharmaceutical, food and research industries.

Type	Capacity t	Lifting speed full load m/min	Lifting speed without load m/min	Air consumption full load l/sec	Weight kg
TCR-600250 C/P	0.25	14.0	19.0	21.6	30
TCR-500 C/P	0.5	10.5	20.5	25	31
TCR-1000/2 C/P	1	5.3	10.3	25	34
TCR-1000 C/P	1	6.0	11.3	25	35
TCR-2000/2 C/P	2	3.0	5.7	25	40
TCR-3000 C/P	3	2.8	5.7	33	69
TCR-6000/2 C/P	6	1.4	2.9	33	90

Detailed information on pages 112-113.

TCR-600250

Description	Model	Type	Max. m
Chain bag	A	SW-1	14
Chain bucket	B A		7
Chain bucket	B D		11
Chain bucket	B E		17
Chain bucket	B F		34
Chain bucket	B G		46
Chain bucket	C GB-600520/6		6
Chain bucket	C GB-600520/12		12
Chain bucket	C GB-600520/18		18
Chain bucket	C GB-600520/24		24
Chain bucket	C GB-600520/30		30
Chain bucket	C GB-600520/36		36

TCR-500

Description	Model	Type	Max. m
Chain bag	A	SW-1	14
Chain bucket	B A		7
Chain bucket	B D		11
Chain bucket	B E		17
Chain bucket	B F		34
Chain bucket	B G		46
Chain bucket	C GB-600520/6		6
Chain bucket	C GB-600520/12		12
Chain bucket	C GB-600520/18		18
Chain bucket	C GB-600520/24		24
Chain bucket	C GB-600520/30		30
Chain bucket	C GB-600520/36		36

TCR-1000/2

Description	Model	Type	Max. m
Chain bag	A	SW-1	7
Chain bucket	B A		4
Chain bucket	B D		6
Chain bucket	B E		8
Chain bucket	B F		18
Chain bucket	B G		23
Chain bucket	C GB-601040/3		3
Chain bucket	C GB-601040/6		6
Chain bucket	C GB-601040/9		9
Chain bucket	C GB-601040/12		12
Chain bucket	C GB-601040/15		15
Chain bucket	C GB-601040/18		18

F/G/FF/GG = From these chain lengths onward, a counterbalance or safety sling is necessary. Other chain bags or - buckets for bigger hoists available on request.

10 - 100 tonnes



Red Rooster specializes in the design of hoisting systems tailored to meet specific applications. Internal silencing, fail-safe totally enclosed disc brake, sealed precision epicyclic gearbox, precision machined and hardened load and idler wheels and line pull limiter serve to make the hoists safe, reliable and well engineered production tools. All pendant control types are available with an emergency stop (red, mushroom head) to meet European Machinery (Safety) Directive. All types may be supplied with hook top suspension or combined with trolleys.

Type	Capacity t	Lifting speed full load m/min	Lifting speed without load m/min	Air consumption full load l/sec	Weight kg
RRI-610040 C/P	10	1.5	2.5	90	190
TCR-12000 C/P	12	0.9	1.5	33	170
TCR-15000 C/P	15	0.7	1.0	33	221
RRI-615060 C/P	15	1.0	1.4	90	190
RRI-620080 C/P	20	0.8	1.2	90	240
RRI-625040 C/P	25	0.8	1.3	120	320
RRI-635060 C/P #	37.5	0.6	1.0	120	850
RRI-650080 C/P #	50	0.4	0.7	120	1.100
RRI-675120 C/P #	75	0.25	0.4	120	1.500

= Also available in shackle execution
Detailed information on pages 112-113.

TCR-1000

Description	Model	Type	Max. m
Chain bag	A	SW-2	10
Chain bucket	B AA		7
Chain bucket	B DD		10
Chain bucket	B EE		15
Chain bucket	B FF		28
Chain bucket	B GG		40
Chain bucket	C GB-601020/3		3
Chain bucket	C GB-601020/6		6
Chain bucket	C GB-601020/9		9
Chain bucket	C GB-601020/12		12
Chain bucket	C GB-601020/15		15
Chain bucket	C GB-601020/18		18

TCR-2002/2

Description	Model	Type	Max. m
Chain bag	A	SW-2	5
Chain bucket	B AA		3
Chain bucket	B DD		5
Chain bucket	B EE		7
Chain bucket	B FF		14
Chain bucket	B GG		20
Chain bucket	C GB-602040/3		3
Chain bucket	C GB-602040/6		6
Chain bucket	C GB-602040/8		8
Chain bucket	C GB-602040/12		12
Chain bucket	C GB-602040/15		15
Chain bucket	C GB-602040/18		18

TCR-3000

Description	Model	Type	Max. m
Chain bag	A	SW-3	6
Chain bucket	C GB-603020/3		3
Chain bucket	C GB-603020/6		6
Chain bucket	C GB-603020/8		8
Chain bucket	C GB-603020/12		12
Chain bucket	C GB-603020/15		15
Chain bucket	C GB-603020/18		18

TCR-6000/2

Description	Model	Type	Max. m
Chain bag	A	SW-3	3
Chain bucket	C GB-606040/3		3
Chain bucket	C GB-606040/6		6
Chain bucket	C GB-606040/8		8
Chain bucket	C GB-606040/12		12
Chain bucket	C GB-606040/15		15
Chain bucket	C GB-606040/18		18

F/G/FF/GG = From these chain lengths onward, a counterbalance or safety sling is necessary. Other chain bags or - buckets for bigger hoists available on request.

Air chain hoists

0.125 - 100 tonnes

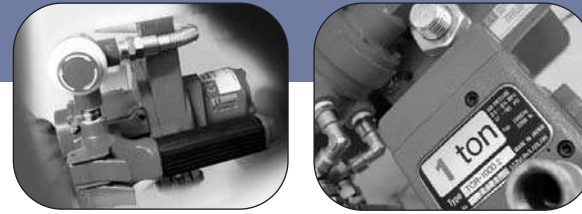

RRI-610040

Druckluftbezüge 0.125 - 100t

Type	Capacity t	Lifting speed full load m/min	Lowering speed full load m/min	Lifting speed without load m/min	Lowering speed without load m/min	Number of chain falls	Air consumption full load l/sec	Inlet-thread	Hose diameter mm	Weight incl. 3 m lift kg	Load limiter	Air trolley	4-button control with emergency stop (VTP-4E)	Chain size mm	Chain weight kg/m	Chain bag/chain bucket	SMC air treatment unit
TCR-125 C/DP	0.125	14.0	16	19.0	13	1	11.7	PT 3/8"	13	7	-	+	+	4.0 x 12.0 (HD)	0.35	+	AC30A-F03E
TMM-140AE	0.14	11.0	15	15.0	11	1 (wire-rope)	8	PT 3/8"	13	9	-	+	-	-	-	-	AC30A-F03E
TCR-250 C/DP	0.25	9.3	17	19.0	13	1	11.7	PT 3/8"	13	7	-	+	+	4.0 x 12.0 (HD)	0.35	+	AC40A-F04E
TCR-600250 C/P	0.25	14.0	18	19.0	13	1	21.6	PT 1/2"	13	30	-	+	+	6.3 x 19.1	0.9	+	AC40A-F04E
TCR-500/2 C/DP	0.5	4.5	8,5	9.5	6,5	2	11.7	PT 3/8"	13	8.5	-	+	+	4.0 x 12.0 (HD)	0.35	+	AC30A-F03E
TCS-500 C/P	0.5	17	43	33	19	1	33	PT 1/2"	13	15.9	-	+	+	6.3 x 19.1	0.9	+	AC40A-F04E
TCR-500 C/P	0.5	10.5	17,9	20.5	13,4	1	25	PT 1/2"	13	31	*	+	+	6.3 x 19.1	0.9	+	AC40A-F04E
TCR-1000/2 C/P	1	5.3	9,0	10.3	6,7	2	25	PT 1/2"	13	34	*	+	+	6.3 x 19.1	0.9	+	AC40A-F04E
TCR-1000 C/P	1	6.0	10,3	11.3	6,8	1	25	PT 1/2"	13	35	*	+	+	7.1 x 21	1.1	+	AC40A-F04E
TCR-2000/2 C/P	2	3.0	5,2	5.7	3,4	2	25	PT 1/2"	13	40	*	+	+	7.1 x 21	1.1	+	AC40A-F04E
TCR-3000 C/P	3	2.8	4,6	5.4	3,3	1	33	PT 1/2"	19	69	*	+	+	11.2 x 34	2.2	+	AC40A-F04E
TCR-6000/2 C/P	6	1.4	2,3	2.7	1,7	2	33	PT 1/2"	19	90	*	+	+	11.2 x 34	2.2	+	AC40A-F04E
RRI-610040 C/P	10	1.5	2,3	2.2	1,8	2	90	PT 1"	25	190	*	+	+	16 x 45	5.0	+	AC50A-F06E
TCR-12000 C/P	12	0.7	1,2	1.4	0,8	4	33	PT 1/2"	19	170	*	+	+	11.2 x 34	2.2	+	AC40A-F04E
TCR-15000 C/P	15	0.6	0,9	1.1	0,7	5	33	PT 1/2"	19	221	*	+	+	11.2 x 34	2.2	+	AC40A-F04E
RRI-615060 C/P	15	1.0	1,5	1.7	1,2	3	90	PT 1"	25	190	*	+	+	16 x 45	5.0	+	AC50A-F06E
RRI-620080 C/P	20	0.8	1,2	1.2	0,9	4	90	PT 1"	25	240	*	+	+	16 x 45	5.0	+	AC50A-F06E
RRI-625040 C/P	25	0.5	0,7	0.7	0,5	2	120	PT 1"	25	320	*	+	+	22 x 66	10.0	+	AC60A-F10E
RRI-635060 C/P#	37.5	0.3	0,5	0.5	0,3	3	120	PT 1"	25	850	*	+	+	22 x 66	10.0	+	AC60A-F10E
RRI-650080 C/P#	50	0.25	0,35	0.35	0,25	4	120	PT 1"	25	1.100	*	+	+	22 x 66	10.0	+	AC60A-F10E
RRI-675120 C/P#	75	0.2	0,2	0.2	0,2	6	120	PT 1"	25	1.500	*	+	+	22 x 66	10.0	+	AC60A-F10E

* Supplied as standard | + = on request | # = also available in shackle execution
 C = cord control | DP = direct pendant control with emergency stop | P = pilot pendant control with emergency stop

Note - Chain, SMC filter and SMC lubricator are supplied on request.
 - 4- or 6- pendant control with emergency stop on request

All hoists are supplied as standard with 2 m. control, with exception of type TMM-140A; standard with cable, air hose, pilot pendant control and 2 m. height of lift.

Features of the shackle execution: a lower head room, lower weight, easier to load the hoist and easy mounting by double pad eye.

EN-818-7 chain is standard for all air chain hoists, with exception of models TCR-125 and TCR-250. For these models a Heavy Duty (HD) chain is available. All chains supplied on request.



SMC AF Filter



SMC AL Lubricator

Air trolleys

0.125 - 50 tonnes

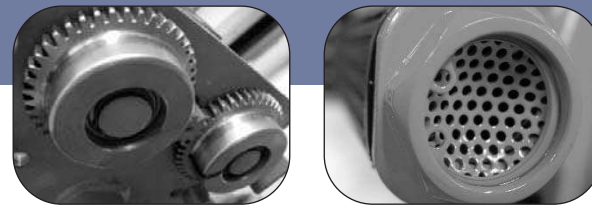

TCR-2000/2 with ATPSR-602040/1

Air trolleys - standard

For hoists	Type	For Capacity t	Type air trolley	Flange width mm	Trav. speed full load m/min	Min. bend radius m	Number of wheels	Driven wheels	Air consumption l/sec	Inlet-thread
TCR-125	ATP500	0.125	1N	56-178	0.12	1.5	4	2	13	PT 3/8"
TCR-250	ATP500	0.250	1N	56-178	0.12	1.5	4	2	13	PT 3/8"
TCR-500/2	ATP500	0.5	1N	56-178	0.12	1.5	4	2	13	PT 3/8"
TCR-600250	ATP600250/1	0.5	1N	56-170	0-9.5	1.5	4	2	25	PT 1/2"
TCR-500	ATP600520/1	0.5	2N	171-300	0-9.5	1.5	4	2	25	PT 1/2"
TCS-500	ATP600520/1	0.5	2N	171-300	0-9.5	1.5	4	2	25	PT 1/2"
TCR-1000/2	ATP601040/1	1.0	1N	56-170	0-9.5	1.5	4	2	25	PT 1/2"
TCR-1000	ATP601040/2	1.0	2N	171-300	0-9.5	1.5	4	2	25	PT 1/2"
TCR-2000/2	ATP602040/1	2.0	1N	56-170	0-9.5	1.5	4	2	25	PT 1/2"
	ATP602040/2	2.0	2N	171-300	0-9.5	1.5	4	2	25	PT 1/2"
TCR-3000	ATP603020/1	3.0	1N	65-150	0-9.5	2.0	4	2	50	PT 3/4"
	ATP603020/2	3.0	2N	155-300	0-9.5	2.0	4	2	50	PT 3/4"
TCR-6000/2	ATP606040/1	6.0	1N	82-170	0-9.5	2.5	4	2	50	PT 3/4"
	ATP606040/2	6.0	2N	180-300	0-9.5	2.5	4	2	50	PT 3/4"
RRI-610040	ATP610040/1	10.0	1N	110-190	0-9.5	2.5	4	2	50	PT 3/4"
	ATP610040/2	10.0	2N	200-300	0-9.5	2.5	4	2	50	PT 3/4"
TCR-12000	ATP612080/1	12.0	1N	110-190	0-9.5	3.0	4	2	50	PT 3/4"
	ATP612080/2	12.0	2N	200-300	0-9.5	3.0	4	2	50	PT 3/4"
TCR-15000	ATP-615100/1	15.0	1N	110-190	0-9.5	3.0	4	2	80	PT 3/4"
RRI-615060	ATP-615100/2	15.0	2N	200-300	0-9.5	3.0	4	2	80	PT 3/4"
RRI-620080	ATP-620080/1	20.0	1N	110-190	0-9.5	3.0	4	2	80	PT 1"
RRI-615060	ATP-615060/2	20.0	2N	200-300	0-9.5	3.0	4	2	80	PT 1"
RRI-625040	ATP-625040/1	25.0	1N	110-190	0-9.5	3.0	4	2	80	PT 1"
	ATP-625040/2	25.0	2N	200-300	0-9.5	*	8	4	100	PT 1"
RRI-635060	ATP-635060/1	35.0	1N	110-190	0-6.3	*	8	4	150	PT 1 1/4"
	ATP-635060/2	35.0	2N	200-300	0-6.3	*	8	4	150	PT 1 1/4"
RRI-650080	ATP-635060/1	50.0	1N	110-190	0-4.0	*	8	4	150	PT 1 1/4"
	ATP-635060/2	50.0	2N	200-300	0-4.0	*	8	4	150	PT 1 1/4"
RRI-650080	ATP-650080/1	50.0	1N	110-190	0-6.3	*	16	8	200	PT 1 1/2"
	ATP-650080/2	50.0	2N	200-300	0-6.3	*	16	8	200	PT 1 1/2"

* Straight only
Note Air trolleys for lower minimum bending radius on request / Air trolleys with extremely low head room on request.

Air trolleys - spark resistant

For hoists	Type	For Capacity t	Type air trolley	Flange width mm	Trav. speed full load m/min	Min. bend radius m	Number of wheels	Driven wheels	Air consumption l/sec	Inlet-thread
TCR-600250	ATPSR-600250/1	0.25	1SR	56-170	0-9.5	1.5	4	2	25	PT 1/2"
TCR-500	ATPSR-600520/2	0.5	2SR	171-300	0-9.5	1.5	4	2	25	PT 1/2"
TCS-500	ATPSR-600520/2	0.5	2SR	171-300	0-9.5	1.5	4	2	25	PT 1/2"
TCR-1000/2	ATPSR-601040/1	1.0	1SR	56-170	0-9.5	1.5	4	2	25	PT 1/2"
TCR-1000	ATPSR-601040/2	1.0	2SR	171-300	0-9.5	1.5	4	2	25	PT 1/2"
TCR-2000/2	ATPSR-602040/1	2.0	1SR	56-170	0-9.5	1.5	4	2	25	PT 1/2"
	ATPSR-602040/2	2.0	2SR	171-300	0-9.5	1.5	4	2	25	PT 1/2"
TCR-3000	ATPSR-603020/1	3.0	1SR	56-150	0-9.5	2.0	4	2	50	PT 3/4"
	ATPSR-603020/2	3.0	2SR	155-300	0-9.5	2.0	4	2	50	PT 3/4"
TCR-6000/2	ATPSR-606040/1	6.0	1SR	82-170	0-9.5	2.5	4	2	50	PT 3/4"
	ATPSR-606040/2	6.0	2SR	180-300	0-9.5	2.5	4	2	50	PT 3/4"
RRI-610040	ATPSR-610040/1	10.0	1SR	110-190	0-9.5	2.5	4	2	50	PT 3/4"
	ATPSR-610040/2	10.0	2SR	200-300	0-9.5	2.5	4	2	50	PT 3/4"
TCR-15000	ATPSR-615100/1	15.0	1SR	110-190	0-9.5	3.0	4	2	80	PT 3/4"
RRI-615069	ATPSR-615100/2	15.0	2SR	200-300	0-9.5	3.0	4	2	80	PT 3/4"
RRI-625040	ATPSR-625040/1	25.0	1SR	110-190	0-9.5	3.0	4	2	80	PT 1"
RRI-625040	ATPSR-625040/2	25.0	2SR	200-300	0-9.5	*	8	4	100	PT 1"

* Straight only
Note Push & geared trolleys on request built on and hook on (also for spark resistant models).

All Red Rooster air trolleys are adjustable for various runway beam widths and types. Flanged trolley wheels running on sealed bearings are driven by an open precision machined pinion. The powerful rotary vane motor and enclosed gearbox afford the user proportional, smooth speed control and positive braking.

Standard trolleys are supplied with cast iron wheels. The spark resistant models have been manufactured with bronze wheels. Air trolleys for air chain hoists up to 100 t on request.



Bronze wheels

Anti-drop plates and anti-tip rollers are included as standard safety features; whilst rack and pinion drive, pneumatic end limits and swivel top suspension bearings (for use on board ship and for BOP handling on offshore drilling rigs), are available as options.

Dimensions

Air chain hoists

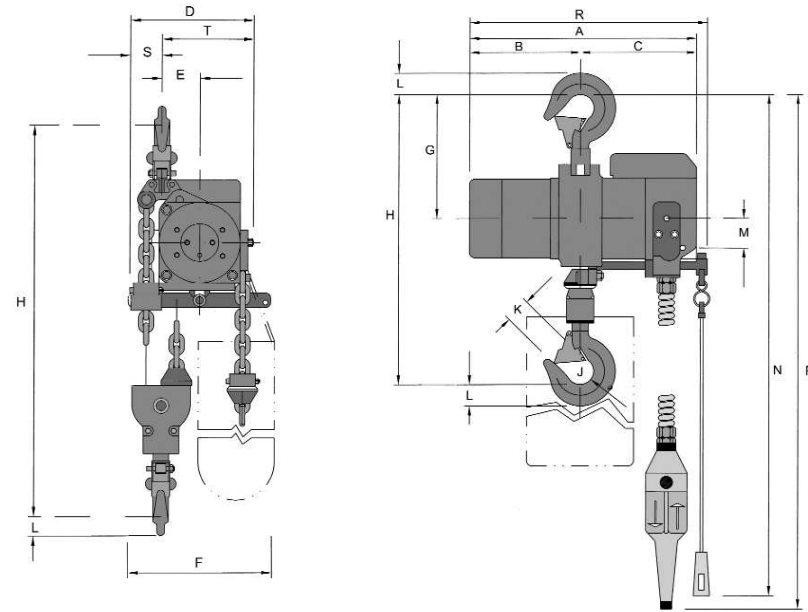

Air chain hoists

Type	A mm	B mm	C mm	D mm	E mm	F mm	G mm	H mm	J mm	K mm	L mm	M mm	N mm	P mm	R mm	S mm	T mm
TCR-125	230	110	120	95	20	102	240	305	36	29	15	-	2180	2580	230	35	60
TMM-140AE	550	225	115	237	23	115	90	572	35	29	15	-	-	-	224	110	127
TCR-600250	321	156	165	149	32	212	177	472	40	34	29	40	2260	2650	355	40	109
TCR-250	230	110	120	95	20	102	240	305	36	29	15	-	2180	2580	230	35	60
TCR-500	321	156	165	149	32	212	177	472	40	34	29	40	2260	2650	355	40	109
TCR-500/2	230	110	120	140	40	105	240	365	36	25	*	-	2180	2580	230	45	95
TCS-500	365	193	161	140	58	161	156	410	36	34	16	-	2060	2460	365	28	120
TCR-1000/2	321	156	165	180	56	212	177	529	40	34	29	40	2260	2650	355	47	133
TCR-1000	321	156	165	157	32	212	177	476	40	34	29	40	2260	2650	355	40	117
TCR-2000/2	321	156	165	194	59	212	203	563	45	32	37	40	2285	2675	355	50	144
TCR-3000	430	202	228	245	43	212	249	563	50	41	45	40	2350	2850	464	47	168
TCR-6000	430	202	228	275	87	212	275	673	65	50	49	40	2350	2850	464	63	212

* L top = 17 / L bottom = 23

Type	B mm	C mm	H mm	K mm	R mm	S mm	T mm
RRI-610040	247	302	1.270	70	549	165	277
RRI-615060	247	302	1.250	85	549	180	290
RRI-620080	247	302	1.350	100	549	200	300
RRI-625040	335	375	1.400	80	710	165	275
RRI-635060	335	375	1.550	100	710	250	400
RRI-650080	335	375	1.980	100	710	250	350
RRI-650080*	335	375	1.505	-	710	250	350

* Shackle execution

Air trolleys

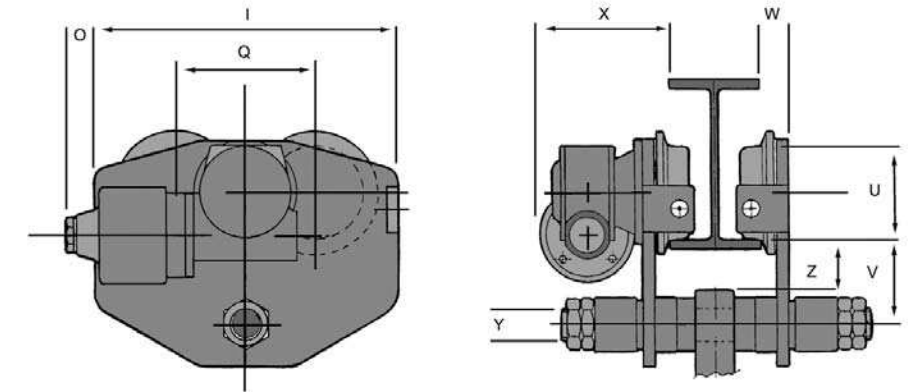

Air trolleys

Capacity t	Number of wheels	Weight kg	I mm	Q mm	U mm	V mm	W mm	X mm	Y mm	Z mm
Mini's	4	9	250	100	60	42	20	130	20	22
0-2	4	27	230	106	70	67	27	140	35	27
3	4	40	320	148	100	90	29	142	35	45
6	4	71	460	216	150	100	38	220	45	55
10	4	140	460	216	150	100	43	225	45	50
12	4	140	460	216	150	100	43	225	45	50
15	4	150	530	252	180	110	43	260	50	50
20	4	200	630	300	230	120	48	320	60	50
25	4	200	630	300	230	120	48	320	60	50
25	8	360	940	216	150	105	260	260	60	50
35	8	450	1100	252	180	125	320	320	70	50
50	8	620	1280	300	180	125	320	320	70	50
50	16	940	2060	252	150	125	260	260	70	50



Chain selection!

Standard	Heavy Duty
6.3 x 19,1	6.3 x 19.1 S
7.1 x 21	7.1 x 21 S
11.2 x 34	11.2 x 34 S
16 x 45	16 x 45 S
22 x 66	22 x 66 S

Red Rooster hoists are standard supplied with a galvanized chain according to EN-818-7. If the hoist is intensively operated, constantly max. loaded, or used for rental jobs, we advise to use the higher quality chain. A Heavy Duty chain has a much higher resistance against wear. Lubrication of the chain may increase the life-time to 10 times.

Dimensions

Air chain hoists

Hoist and trolley combined

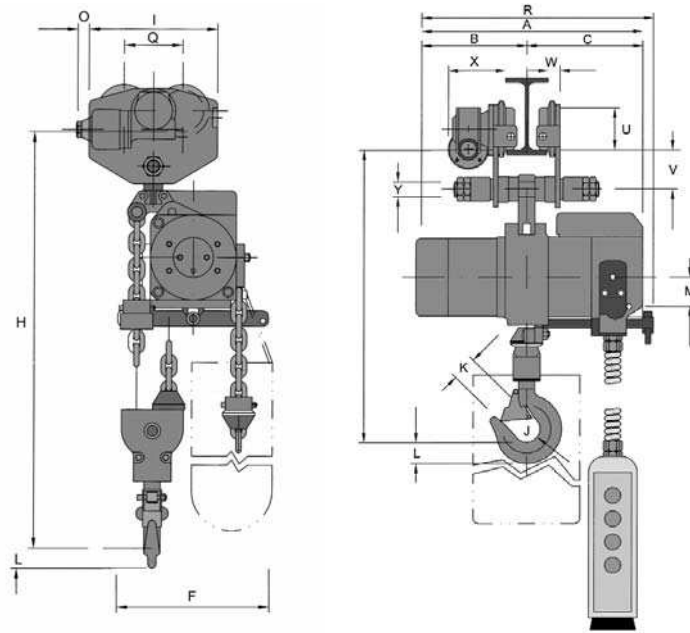

Hoist and trolley combined

Type	A mm	B mm	C mm	H mm	J mm	K mm	L mm	M mm	R mm	U mm	V mm	W mm	X mm	Y mm
TCR-125	230	110	120	300	36	29	15	-	230	60	45	19	130	20
TCR-600250	318	153	165	513	40	34	29	40	330	70	67	27	140	35
TCR-250	230	110	120	300	36	29	15	-	230	60	45	19	130	20
TCR-500	318	153	163	513	40	34	29	40	330	70	67	27	140	35
TCR-1000/2	318	153	163	583	40	34	29	40	330	70	67	27	140	35
TCR-1000	323	156	157	500	40	34	29	40	340	70	67	27	140	35
TCR-2000/2	323	156	167	555	45	32	37	40	340	70	67	27	140	35
TCR-3000	430	226	202	620	64	41	48	43	443	100	90	29	142	45
TCR-6000	428	202	226	695	65	50	19	40	445	150	100	38	220	45

Note Larger models available on request
TCS-500 on request

Spark resistant

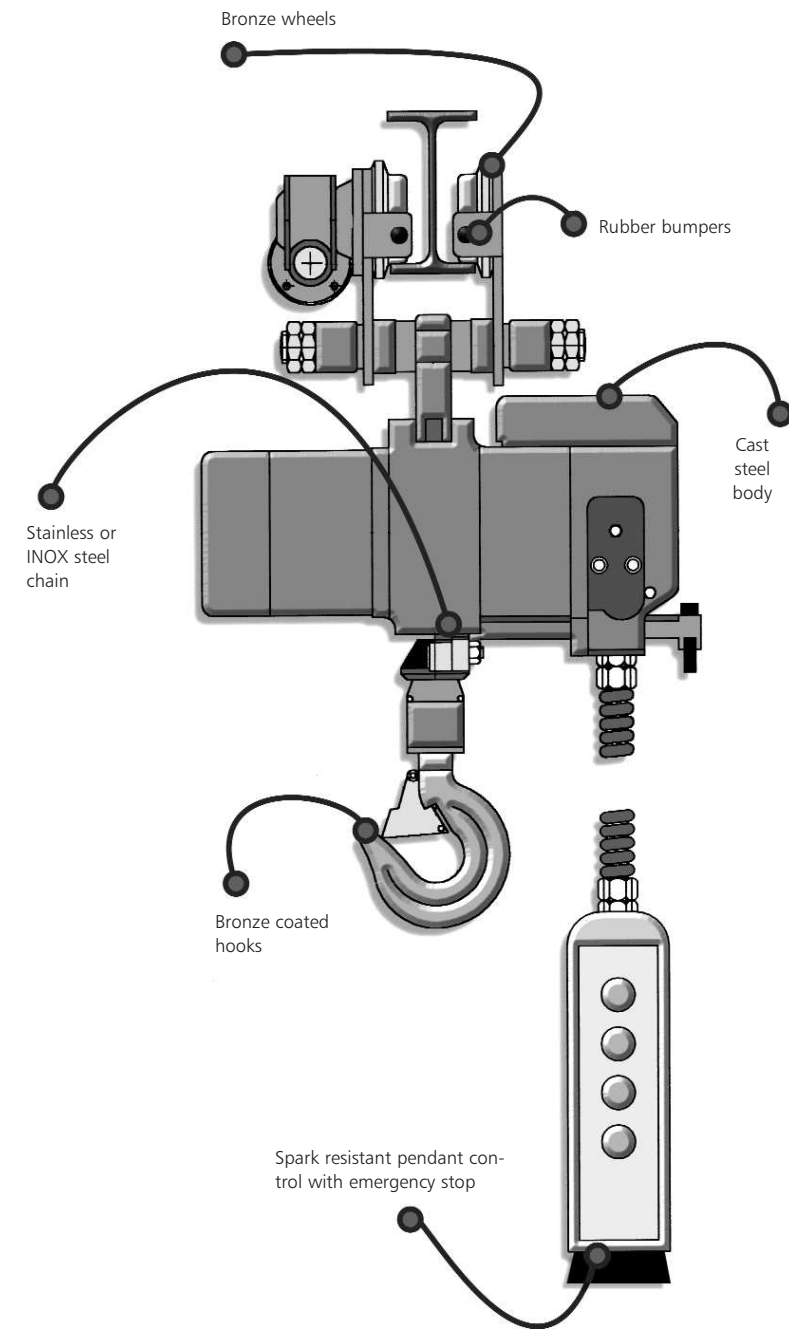

In production- and storage operations, inflammable gases, vapours and mist combined with air, may form an explosive atmosphere. Such gases and vapours are classified under European norms. These hoists are therefore supplied with an "ATEX" certificate.

Our standard hoists are classified as follows: E Ex II A T6 CE Ex II 3GD (and may be used in zone 2).

Our spark resistant hoists are classified as follows: E Ex IIA/IIB T6 CE Ex II 2GD (and may be used in zone 1).

Exception is the mini hoist TMM-140AE.

Red Rooster spark resistant hoists are executed with:

- Cast steel body ¹⁾²⁾
- Bronze coated hooks ³⁾
- Stainless or INOX steel chain
- Spark resistant pendant control with emergency stop
- Heavy Duty rubber collision bumpers on trolley
- Bronze wheels on trolley
- Nickered hook used for the food industry

- ¹⁾ Copper plated sprockets on request
- ²⁾ Marine paint on request
- ³⁾ Stainless steel on request

Applications

Our spark resistant hoists are widely used in a.o. the On- and Off-shore, (petro)chemical industry, mining, paint industry, paint spraying, chemical production and -storage, pharmaceutical industry, tank-cleaning.



VTP-4E

4-button control with emergency stop to operate hoist and trolley at the same time.

All hoists are dynamically tested in our workshop with actual load. All overload tests are carried out with 150% x W.W.L. Hoists are supplied with a test certificate. The test bench itself has been calibrated and certificated by TNO certification and meets the requirements according to NEN-EN 818.

15. Winches

0.2 - 35 tonnes

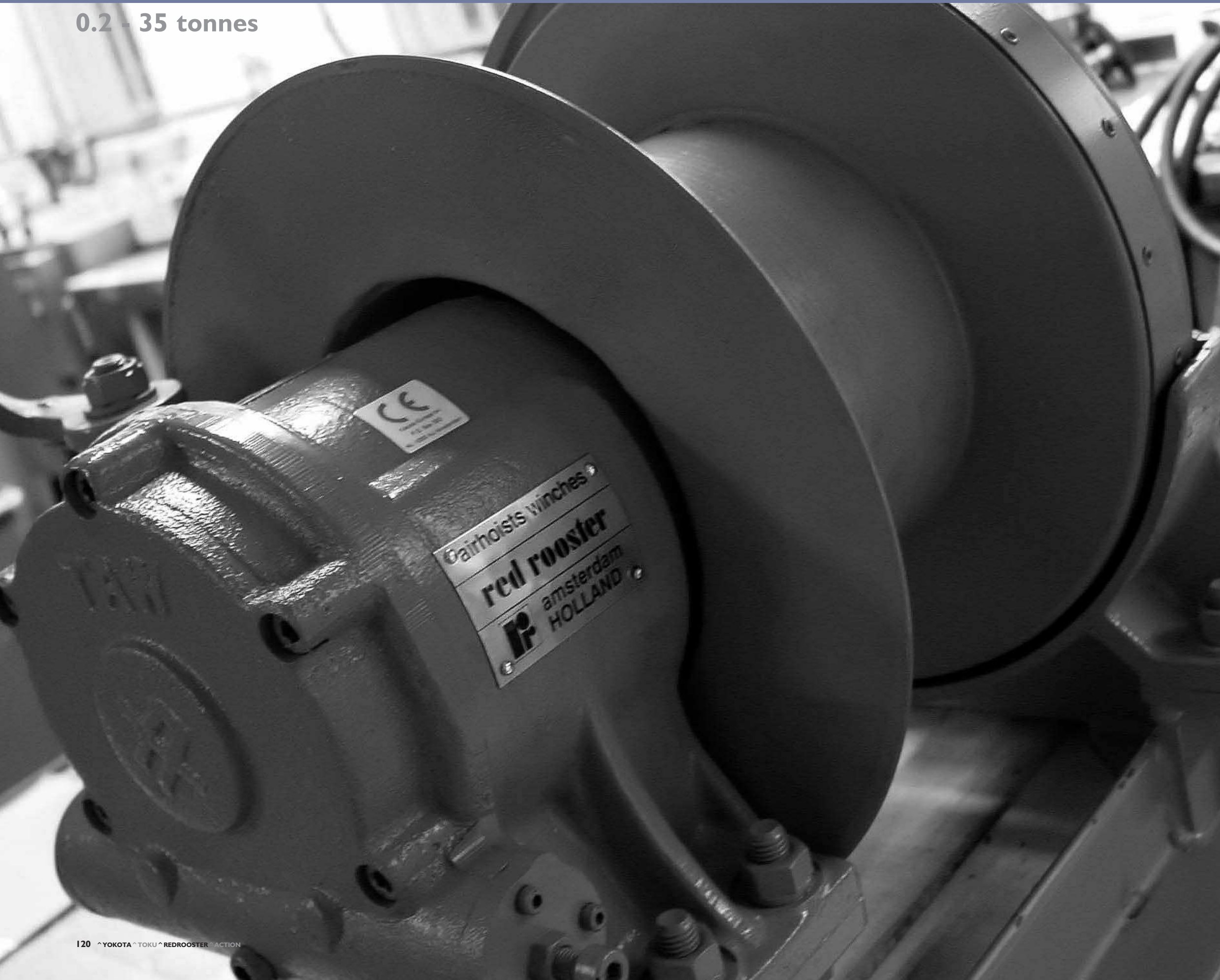

Red Rooster air winches are custom made products. Many constructions are possible, and there are many norms and selection criteria for choosing a winch. In this foreword we discuss several of these to help you in your selection.

Applications

Hoisting and pulling of various equipment and loads on ships, offshore, shipyards etc. For manrider winches, please send your enquiry.

Standard winches, RRI series

- Vane type motor
- Standard band brake and automatic brake
- Free-wheel
- Very compact design as air motors are partially contained inside the drums
- Rugged but lightweight construction
- Easy installation and removal
- Safety type throttle provides flexible speed control, shuts of automatically when released
- All steel

Optional

- Silencers
- Air treatment unit, consisting of filter, regulator and lubricator

Elektrical winches, RRI series

Please contact your local supplier!

Winches

RRI series - standard pneumatic winches

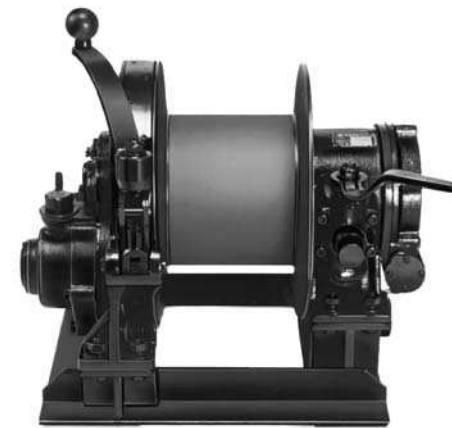

RRI-700500

RRI series

Type	Brand	Capacity t	Drive	Cable length m	Cable diameter mm	Cable speed m/min	Air consumption l/sec	Weight without cable kg	Hose diameter mm
RRI-700500	RRI	0.5	Pneumatisch	100	8	20	57	70	19
RRI-701000	RRI	1.0	Pneumatisch	100	10	6.7	57	80	19
RRI-701500	RRI	1.5	Pneumatisch	80	12	5.5	57	88	19
RRI-702000	RRI	2.0	Pneumatisch	65	16	5.0	70	130	19

Dimensions

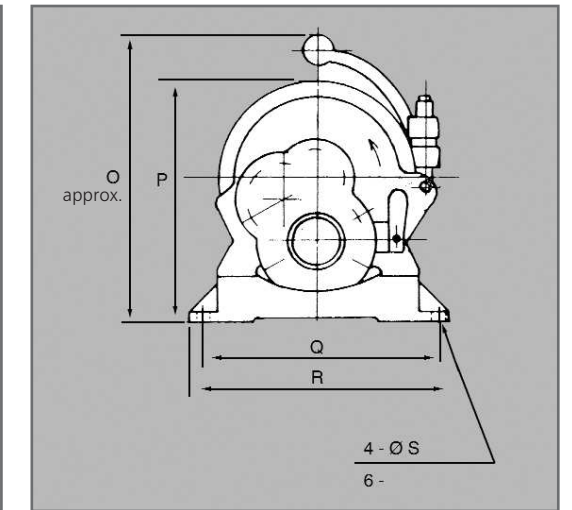
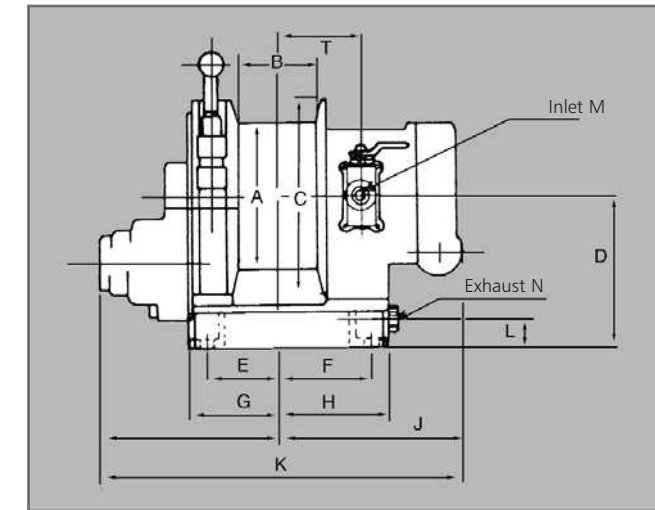

Dimensions RRI series

Type	A mm	B mm	C mm	D mm	E mm	F mm	G mm	H mm	I mm	J mm	K mm	L mm	O mm	P mm	Q mm	R mm	S mm	T mm
RRI-700500	180	150	308	225	200	160	220	180	255	219	474	58	455	379	310	350	14	124
RRI-701000	200	243	340	225	254	208	270	226	317	266	583	58	475	395	310	350	14	171
RRI-701500	200	243	340	225	254	208	270	226	317	266	583	58	475	395	310	350	14	171
RRI-702000	300	236	460	286	250	206	270	226	317	266	583	58	587	516	420	460	14	171



RRI-702000

Winches

LV series - pneumatic wormgear winches

For pneumatic winch applications demanding light weight construction, this range of explosion proof winches provides the solution. The use of vane type motors and inherently safe self braking worm gears ensures trouble free operation and low maintenance is required. These winches find their use in general industry, oil and gas exploration, and in many places where compact explosion proof hoisting gear is required.

The range includes two fast speed types, the LV-256 and LV-508, which also have optional carrying handles, and slower speed types up to 2000 kg lifting capacity.

The self braking characteristics of the worm gear drive combined with closed ports is sufficient for almost all hoisting purposes. For accurate positioning of a load an additional brake may be necessary. Please consult our sales department in this case.



LV series

LV series

Type	Brand	Capacity 1st. layer kg	Capacity 3rd. layer kg	Cable diameter mm	Speed 1st. layer m/min	Drum cap. 1st. layer m	Drum cap. 3rd. layer m	Air consumption l/sec	Pressure drop bar
LV 256	RR1	250	200	5	12	10	32	45	6
LV 508	RR1	500	400	7	12	6	22	80	6
LV 425	RR1	425	350	6	5	10	32	35	6
LV 750	RR1	750	600	8	5.5	7	25	65	6
LV 1250	RR1	1250	1000	10	6	11	36	95	6
LV 2000	RR1	2000	1550	13	6	11	38	125	6

Standard features

- Self braking worm gear transmission
- Rotary vane motor
- Steel drum (not grooved) with cable fixing point at flange
- Two drum supports
- Single layer 1 component conservation (color BS 20 medium blue).

Options

- Manual disengaging clutch
- Band brake, manual or automatic fail safe
- Grooved drum
- Drum pressure roller
- Alternative speeds
- Alternative drum dimensions / split drums / additional rope anchors, etc.
- Motor position vertically up
- Drum guard
- Emergency cranking
- Marine / offshore coating system

Available control options

- Proportional control valve, local or remote
- Pneumatic limit switch
- Pneumatic slack wire switch

Dimensions

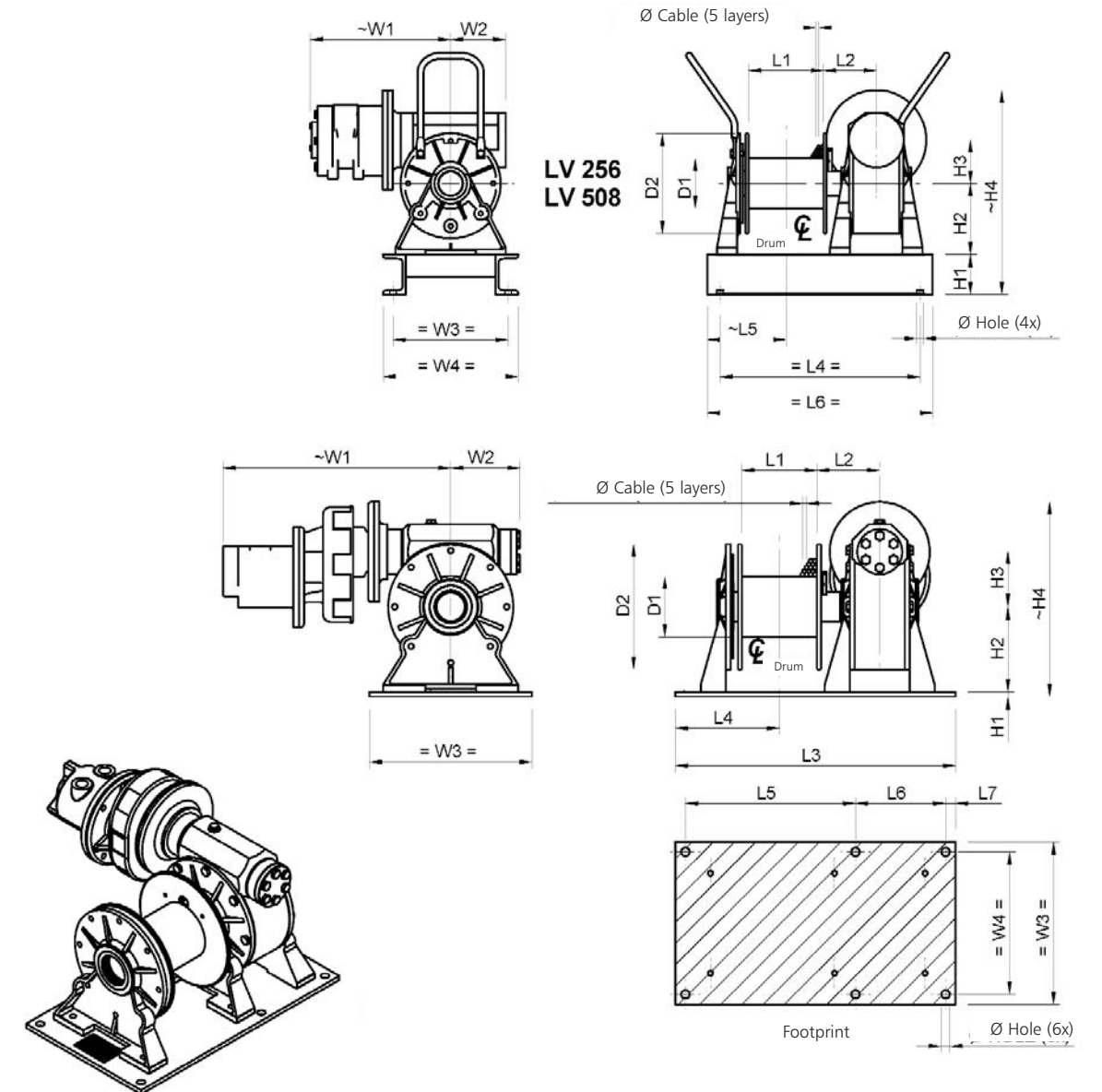

Dimensions LV series

Type	Weight kg	D1 mm	D2 mm	L1 mm	L2 mm	L3 mm	L4 mm	L5 mm	L6 mm	L7 mm	H1 mm	H2 mm	H3 mm	H4 mm	W1 mm	W2 mm	W3 mm	W4 mm	Hole diam.
LV-256	58	100	200	150	105.5	450	157	400	-	-	80	142	86.9	408.9	278	110	270	230	13
LV-425	59	100	200	150	105.5	500	186	320	150	15	10	142	86.9	408.9	374	110	270	240	13
LV-5008	65	100	200	150	105.5	450	157	400	-	-	80	142	86.9	408.9	281	110	270	230	13
LV-750	93	121	250	150	125.5	560	208	340	180	20	10	170	110	390	455	132	325	285	17
LV-1250	149	159	280	200	146.5	640	232.5	415	185	20	15	195	130	440	490	154.3	370	320	17
LV-2000	192	178	320	250	155	710	265	470	200	20	15	220	150	510	609	154	410	360	17

Winches

SB series - standard build planetary winches

The standard build SB type winch provides the basis of the solution to many pulling and lifting winch applications. The winch is constructed in the conventional manner with motor, gearbox and drum in line. This range of capacities can go up to 70 tonnes lifting capacity. Although the name of this winch indicates different, these winches are very suitable to fit to your specific winch application. Many options can be offered on these highly versatile winches.

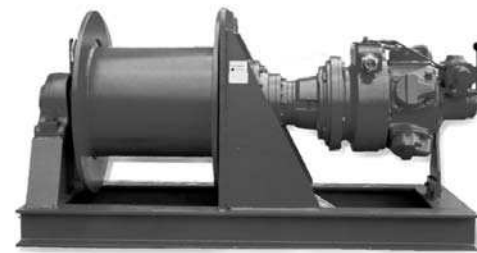

SB series

SB series

Type	Brand	Capacity 1st. layer kg	Capacity 3. layer kg	Cable diameter mm	Speed 1st. layer m/min	Speed 5th. layer m/min	Drum cap. 1st. layer m	Drum cap. 5th. layer m	Motor power kW	Pressure drop bar	Air cons. l/min
SB-300 E	RRI	1.200	860	10	7	9	32	190	1.5	-	-
SB-301 E	RRI	2.100	1.400	12	7	10	27	167	3	-	-
SB-303 E	RRI	2.500	1.700	15	8	12	27	167	4	-	-
SB-305 E	RRI	4.000	2.850	16	8	11	31	186	5.5	-	-
SB-306 E	RRI	5.500	3.970	18	12	17	32	194	11	-	-
SB-307 E	RRI	7.000	4.950	22	12	17	31	184	15	-	-
SB-309 E	RRI	9.000	6.300	26	14	19	29	176	22	-	-
SB-310 E	RRI	13.000	8.950	28	9	13	28	171	22	-	-
SB-311 E	RRI	16.000	10.660	34	10	15	25	157	30	-	-
SB-313 E	RRI	20.000	13.600	38	6	8	27	160	22	-	-
SB-315 E	RRI	32.000	21.700	48	7	11	26	156	45	-	-
SB-303 H	RRI	2.500	1.700	15	20	29	27	167	9	130	50
SB-305 H	RRI	4.000	2.850	16	26	37	31	186	19	215	55
SB-306 H	RRI	5.500	3.970	18	27	37	32	194	27	215	80
SB-307 H	RRI	7.000	4.950	22	30	42	29	184	39	185	130
SB-309 H	RRI	9.500	6.630	26	26	37	29	176	45	225	125
SB-310 H	RRI	13.000	8.950	28	12	18	28	171	30	200	55
SB-311 H	RRI	14.000	9.700	32	10	15	25	157	30	210	115
SB-313 H	RRI	20.000	13.600	38	10	15	27	160	38	170	120
SB-315 H	RRI	32.000	21.700	48	8	12	26	156	50	190	160

SB series - Continued

Type	Brand	Capacity 1st. layer kg	Capacity 3rd. layer kg	Cable diameter mm	Speed 1st. layer m/min	Speed 5th. layer m/min	Drum cap. 1st. layer m	Drum cap. 5th. layer m	Motor power kW	Pressure drop bar	Air cons. l/min
SB-300 LPR2	RRI	1.000	680	10	12	18	27	166	-	7	75
SB-303 LPR2	RRI	2.300	1.575	13	7	10	27	167	-	7	85
SB-303 LPR3	RRI	2.300	1.575	13	14	19	31	186	-	7	130
SB-305 LPR3	RRI	4.000	2.850	16	9	13	31	186	-	7	150
SB-305 LPR4	RRI	4.000	2.850	16	15	21	31	186	-	7	220
SB-306 LPR4	RRI	5.000	3.600	18	11	15	31	180	-	7	230
SB-307 LPR4	RRI	7.000	4.960	22	9	13	30	184	-	7	220
SB-307 LPR5	RRI	7.000	4.960	22	14	20	29	184	-	7	400
SB-309 LPR4	RRI	9.000	6.280	26	7	10	29	177	-	7	200
SB-309 LPR5	RRI	9.000	6.280	26	10	14	29	177	-	7	350
SB-310 LPR4	RRI	13.000	9.000	28	6	8	29	171	-	7	225
SB-310 LPR5	RRI	13.000	9.000	28	8	10	29	171	-	7	350
SB-311 LPR5	RRI	13.000	9.000	30	8	12	28	173	-	7	350
SB-313 LPR6	RRI	20.000	16.500	34	7	9	30	180	-	7	450

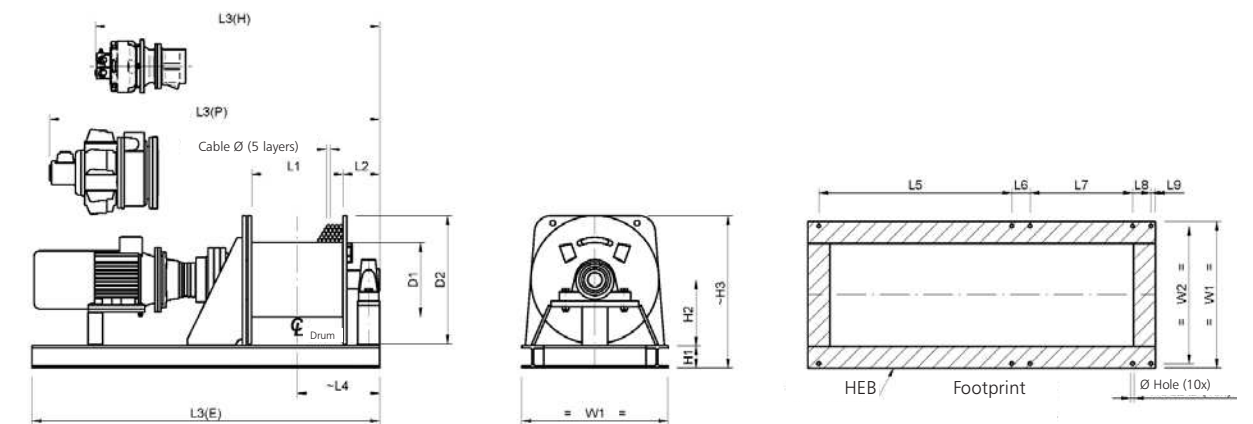

Dimensions SB series

Type	Weight kg	D1 mm	D2 mm	L1 mm	L2 mm	L3(E) mm	L3(H) mm	L3(P) mm	L4 mm	L5 mm	L6 mm	L7 mm	L8 mm	L9 mm	H1 mm	H2 mm	H3 mm	W1 mm	W2 mm	Heb mm	Hole diam.
300	245	195	410	500	155	1400	-	1450	405	630	80	540	80	20	100	215	520	500	460	100	14
301	260	195	410	500	155	1500	-	-	405	730	80	540	80	20	100	215	520	500	460	100	14
303	340	244	500	500	155	1500	1300	1600	405	720	80	550	80	20	100	260	610	600	560	100	14
305	400	298	500	500	155	1600	1300	1600	405	820	80	550	80	20	100	260	610	600	560	100	14
306	620	355	600	500	165	1900	1500	1800	415	1110	80	560	80	20	100	310	710	700	660	100	17
307	790	406	700	500	200	1900	1550	1900	450	1055	100	560	100	25	120	360	830	800	750	120	19
309	1065	455	750	500	215	1950	1550	1950	465	1070	110	560	110	30	140	385	900	900	840	140	22
310	1360	470	850	500	259	2000	1600	1950	509	1050	120	590	120	40	160	435	1020	1000	940	160	26
311	1575	508	950	500	159	2050	1650	1950	509	1100	120	590	120	40	160	495	1130	1100	1040	160	26
313	2220	610	1100	500	260	2100	1800	2150	510	1140	120	590	120	40	180	570	1300	1300	1230	180	32
315	2450	660	1200	500	299	2500	2100	-	549	1490	140	590	140	40	200	620	1420	1500	1420	200	36

Standard features

- Heavy duty planetary gearbox
- SB E: IP 54 aluminium braked motor 400 VAC / 3 phase / 50 Hz. (440VAC / 3 phase / 60 Hz)
- SB H: orbit or radial piston type hydraulic motor complete with brake valve
- SB LPR: radial piston type air motor complete with hand control valve and mufflers
- Steel drum with cable fixing point at flange
- Two drum supports
- Single layer 1 component conservation, (colour BS 20 medium blue).

Options

- IP56 TENV cast iron motor for marine applications
- Explosion proof motors
- Protective steel motor cover
- Drum pressure roller
- Band brakes: manual/failsafe autom.
- Manual disengaging clutch
- Alternative speeds
- Alternative supply voltages
- Drum guards
- Spooling gears
- Grooved drums
- Manual emergency crank
- Slip ring mounting
- Alt. drum dimensions / split drums / add. rope anchors / etc.
- Warping head
- Marine / offshore coating systems

Available control options

- Control box IP 55 with push buttons and emergency stop built acc. to NEN 1010
- Control box IP 55 with low voltage IP 65 remote control built acc. to NEN 1010
- Load limiter (required by CE for applications exceeding 1000 kg W.L.L.)
- Radio /infra red remote control
- Frequency inverter for variable speed control
- Limit switches (electric, pneumatic or hydraulic)
- Slack wire switches (electric, pneumatic or hydraulic)
- Proportional local or remote control valve (pneumatic or hydraulic)

Winches

FD series - planetary crane winches

Specially designed for applications where space is at a premium, these compact and light weight lifting winches are ideally suited for installation on cranes, davits and derricks. The single drum support enables the rope to leave the drum at any angle. The heavy duty planetary drive is partly located within and protected by the drum core. The large drum diameters ensure a healthy drum to cable diameter ratio and a sufficient working length despite the short drums.

Working loads up to 8 tons could be possible for these winches, please ask for our offer.



FD series

FD series

Type	Brand	Capacity 1st. layer kg	Capacity Top Lage kg	Cable diameter mm	Speed 1st. layer m/min	Speed Top Lage m/min	Drum cap. 1st. layer m	Drum cap. alle Lagen m	Motor power 400V AC kW	Pressure drop bar	Air cons. l/min
FD-300 E	RRI	950	800/4	8	15	18	17	70/4	2.2	-	-
FD-301 E	RRI	1.850	1.500/4	11	15	19	12	53/4	5.5	-	-
FD-303 E	RRI	2.300	2.000/3	12	12	14	14	43/3	5.5	-	-
FD-305 E	RRI	3.350	2.800/3	14	14	17	13	42/3	7.5	-	-
FD-306 E	RRI	4.100	3.500/3	16	11	13	18	59/3	7.5	-	-
FD-307 E	RRI	5.250	4.500/3	18	15	18	19	60/3	11	-	-
FD-300 H	RRI	950	800/4	8	20	24	17	70/4	-	130	65
FD-301 H	RRI	1.850	1.500/4	11	15	19	12	53/4	-	120	70
FD-303 H	RRI	2.300	2.000/3	12	12	14	14	43/3	-	135	52
FD-305 H	RRI	3.350	2.800/3	14	14	17	13	42/3	-	140	50
FD-306 H	RRI	4.100	3.500/3	16	11	13	18	59/3	-	130	70
FD-307 H	RRI	5.250	4.500/3	18	15	18	19	60/3	-	140	70
FD-300 LPR1	RRI	800	675/4	8	8	10	17	70/4	-	7	30
FD-300 LPR2	RRI	950	800/4	8	18	20	17	70/4	-	7	85
FD-301 LPR2	RRI	1.850	1.500/4	11	9	11	12	53/4	-	7	85
FD-303 LPR2	RRI	2.300	2.000/3	12	7	8	14	43/3	-	7	90
FD-303 LPR3	RRI	2.300	2.000/3	12	15	18	14	43/3	-	7	140
FD-305 LPR3	RRI	3.350	2.800/3	14	12	14	13	42/3	-	7	150
FD-306 LPR4	RRI	4.100	3.500/3	16	15	18	18	59/3	-	7	225
FD-307 LPR4	RRI	5.250	4.500/3	18	13	15	19	60/3	-	7	240

Dimensions

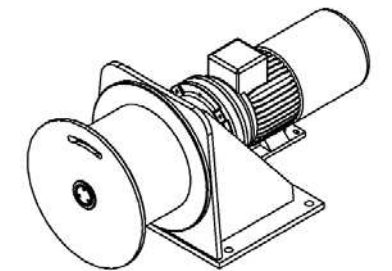
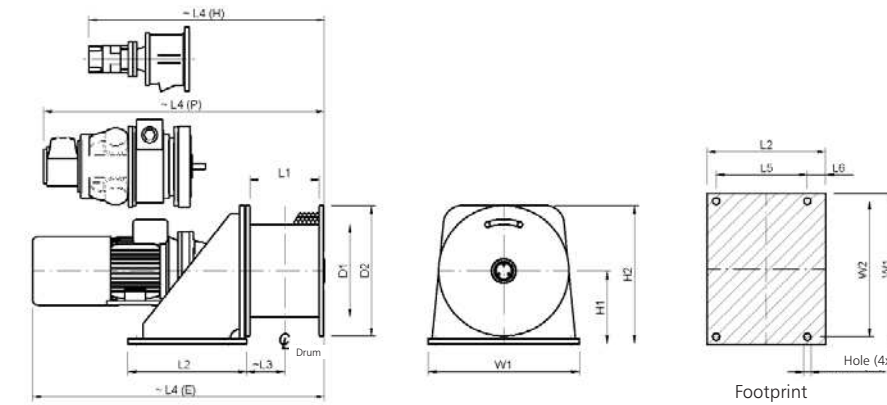

Dimensions FD series

Type	Weight kg	D1 mm	D2 mm	L1 mm	L2 mm	L3 mm	L4(E) mm	L4(H) mm	L4(P) mm	L5 mm	L6 mm	H1 mm	H2 mm	W1 mm	W2 mm	Hole diam.
300	120	244	380	176	310	93	774	548.5	742	240	44	215	405	440	400	18
301	140	244	380	176	310	93	832	557.5	765	240	44	215	405	440	400	18
303	200	272	410	191	350	107.5	894	623	928	275	50	235	440	500	450	22
305	240	272	410	210	350	116	1064	669	1054	275	50	235	440	500	450	22
306	370	355	500	266	455	146	1120	831	1110	350	70	280	530	580	520	27
307	590	406	625	270	510	150	1332	922	1258	400	75	355	668	750	680	27

Standard features

- Heavy duty planetary gearbox
- FD E: IP 54 aluminium braked motor 400 VAC / 3 phase / 50 Hz. (440VAC/ 3 phase / 60 Hz)
- FD H: orbit or radial piston type hydraulic motor complete with brake valve
- FD LPR: radial piston type air motor complete with hand control valve and mufflers
- Steel drum with cable fixing point at flange
- Single drum support
- Single layer 1 component conservation, (colour BS 20 medium blue).

Options

- IP56 TENV cast iron motor for marine applications
- Explosion proof motors
- Protective steel motor cover
- Drum pressure roller
- Alternative speeds
- Alternative supply voltages
- Drum guards
- Marine / offshore coating systems

Available control options

- Control box IP 55 with push buttons and emergency stop built acc. to NEN 1010
- Control box IP 55 with low voltage IP 65 remote control built acc. to NEN 1010
- Load limiter (required by CE for applications exceeding 1000 kg W.L.L.)
- Radio / Infra red remote control
- Frequency inverter for variable speed control
- Limit switches
- Slack wire switches
- Radio / Infrared remote control

Winches

OAW series - Offshore air winches

A range of compact lifting and pulling air winches specially designed for offshore applications and any other hazardous environment where space is limited. The heavy duty planetary gearbox and brake are mounted within the drum core, which both save space and protect from any external damage. Winches designed to meet independent third party requirements, like Lloyds, ABS, DNV, etc.

These standard winches can be fitted with several options and accessories. Further two of the winches are man riding prepared, adding some options and reducing the W.L.L. means that the winch can be used for man riding applications too. For Pod Line and Guide Line operations two standard winches are available with tall flanges and longer drums to accommodate cables up to 2000 meters.

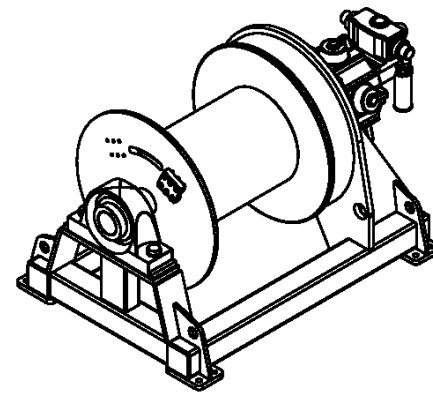

OAW series

Dimensions

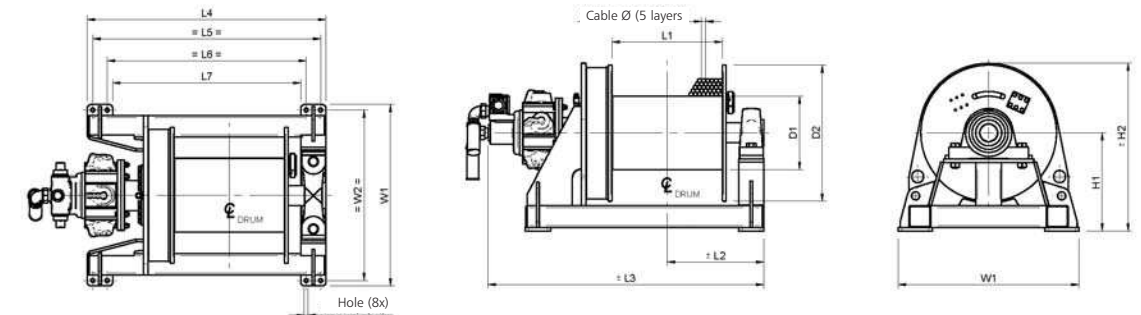

OAW series

Type	Brand	IR equivalent	Capacity 1st. layer kg	Capacity 5th. layer kg	Rope diameter mm	Speed 5th. layer m/min	Drum cap. 5th. layer m	Pressure drop bar	Air cons. l/min
OAW2.0	RRI		2810	2000	13	20	250	7	160
		FA2-24XK1	2730	2000	13	14	234	6.3	160
OAW2.5 LS	RRI	N.A.	3300	2500	16	11	211	6	130
OAW2.5	RRI		3300	2500	16	44	211	7	330
OMR1.5	RRI		2000	1500	13	41	250	5	250
		FA2.5AMR24MK1G	1940	1420	13	61	234	6.3	265
OAW4.5	RRI		6300	4500	19	23	210	7	330
		FA5-24XK1	6900	5000	19	16	224	6.3	330
OMR3.0	RRI		4400	3150	19	23	210	5.5	280
		FA5MR24MK1G	3921	2841	19	36	224	6.3	285
OAW6.5	RRI		9100	6500	22	17	208	7	350
		FA5-24XK1	6900	5000	19	16	224	6.3	330
		FA7-24XK1	9880	7000	22	12	208	6.3	355
OAW6.5 GL	RRI		3760	1545 (17)	19	36 (17)	2000 (17)	6	180
		FA7TGL42	3545	1545 (17)	19	32 (17)	2000 (17)	6.3	355
OAW6.5 PL	RRI		11280	4636 (17)	19	25 (17)	2000 (17)	7	350
		FA7TPL42	10364	4636 (17)	19	20 (17)	2000 (17)	6.3	355
OAW7.0	RRI		9880	7000	22	14	208	7	350
		FA5-24XK1	9880	7000	22	12	208	6.3	355
OAW8.5	RRI		11800	8500	25	12	226	7	350
		FA7-24XK1	9880	7000	25	12	189	6.3	355
OAW10.5	RRI		14000	10500	29	10	231	7	330
		FA-10XK1	14320	10000	28	7	200	6.3	380

Dimensions OAW series

Type	Weight kg	D1 mm	D2 mm	L1 mm	L2 mm	L3 mm	L4 mm	L5 mm	L6 mm	L7 mm	H1 mm	H2 mm	W1 mm	W2 mm	Hole diam.
OAW 2.0	520	298	550	610	470	1468	1120	1060	940	880	395	675	700	660	14
OAW 2.5 LS	520	298	550	610	470	1468	1120	1060	940	880	395	675	700	660	14
OAW 2.5	550	298	550	610	470	1468	1120	1060	940	880	395	675	700	660	14
OAW 1.5	550	298	550	610	470	1468	1120	1060	940	880	395	675	700	660	14
OAW 4.5	800	355	700	610	500	1556	1220	1180	1020	980	475	835	840	790	19
OAW 3.0	800	355	700	610	500	1556	1220	1180	1020	980	475	835	840	790	19
OAW 6.5	1125	406	750	610	535	1576	1320	1260	1100	1040	540	925	1000	940	22
OAW 6.5 GL	1410	406	1070	1067	764	2039	1780	1720	1560	1500	590	1125	1200	1140	22
OAW 6.5 PL	1535	406	1070	1067	764	2039	1780	1720	1560	1500	590	1125	1200	1140	22
OAW 7.0	1125	406	750	610	535	1576	1320	1260	1100	1040	540	925	1000	940	22
OAW 8.5	1615	508	900	610	524	1789	1370	1300	1100	1030	625	1090	1120	1050	26
OAW 10.5	1880	609	1010	610	529	1789	1370	1300	1100	1030	680	1205	1220	1150	26

Standard features

- Heavy duty planetary gearbox integrated in gearbox
- Cast steel five cylinder radial piston motor
- Proportional biased throttle valve
- Exhaust silencing mufflers
- Steel drum, length 610 mm with cable fixing point at flange
- Two drum supports
- Standard temp. range -10° to 50°C
- Oil bath disc brake
- Lifting lugs
- Offshore multi layer 2 component conservation (color RAL 1023 yellow).

Options

- Alternative drum lengths
- Drum pressure rollers / Drum guards
- Drum locking pins / Drum dividers
- Band brakes (manual or automatic failsafe)
- Spooling gears
- Grooved drums
- Tubular offshore frame construction
- Special temp. range -40°C to +50°C
- Natural gas driven

Available control options

- Emergency main shut off valves
- Load limiters
- Limit switches (pneumatic)
- Slack wire switches (pneumatic)
- Proportional remote control valve
- Air service units
- Matching frame with IR, Atlas, Beebe, Chicago or Gardner

16. Accessories

For air tools



Accessories program

Our delivery program is completed with a range of accessories for air tools. In this chapter you will find:

- (Spring)balancers
- Polyurethane air hoses
- Kombi-Kit
- Lubricating oil
- Mini-oilers
- Regulators

(Spring)balancers

Standard / Hosereel with integrated cable

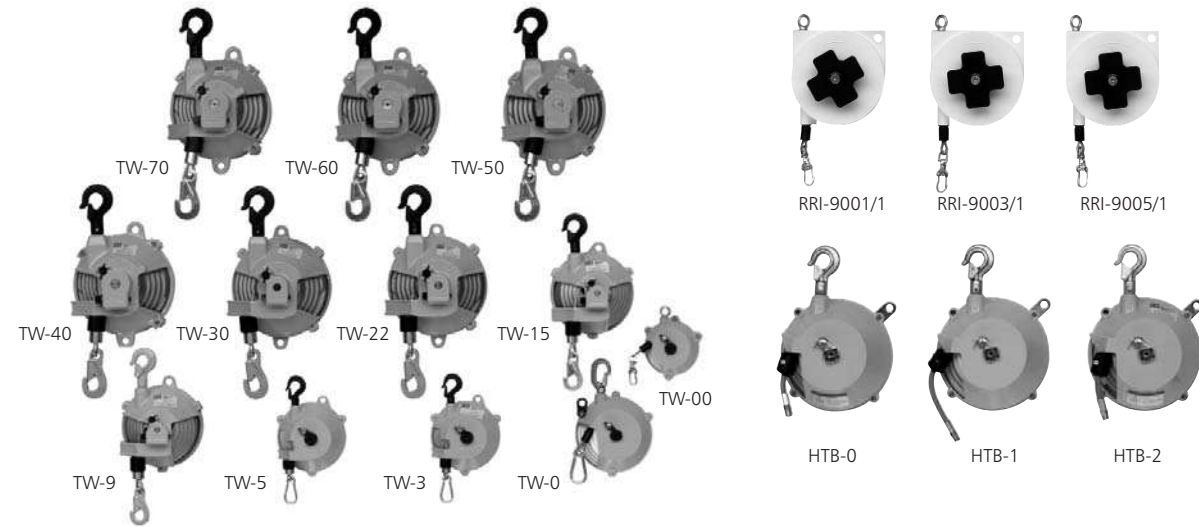

Standard models

Type	Brand	Capacity kg	Cable length m	Weight kg	Hose diameter mm	Air consumption l/min	Inlet-thread
RRI-9001/1	RRI	0.5 - 1.5	2.0	0.5	-	-	-
RRI-9003/1	RRI	1.0 - 3.0	2.0	0.7	-	-	-
RRI-9005/1	RRI	2.5 - 5.0	2.0	0.9	-	-	-
TW-00	RRI	0.5 - 1.5	0.5	0.2	-	-	-
TW-0	RRI	0.5 - 1.5	1.0	0.5	-	-	-
TW-3	RRI	1.0 - 3.0	1.3	1.4	-	-	-
TW-5	RRI	2.5 - 5.0	1.3	1.5	-	-	-
TW-9	RRI	4.5 - 9.0	1.3	3.4	-	-	-
TW-15	RRI	9 - 15	1.3	3.8	-	-	-
TW-22	RRI	15 - 22	1.5	7.2	-	-	-
TW-30	RRI	22 - 30	1.5	7.6	-	-	-
TW-40	RRI	30 - 40	1.5	9.8	-	-	-
TW-50	RRI	40 - 50	1.5	10.4	-	-	-
TW-60	RRI	50 - 60	1.5	11.6	-	-	-
TW-70	RRI	60 - 70	1.5	11.8	-	-	-
ETP-14	RRI	120 - 140	1.2	24.1	-	-	-
ETP-15	RRI	140 - 170	1.2	28.7	-	-	-
ETP-16	RRI	170 - 200	1.2	29.7	-	-	-

Hosereel with integrated cable

HTB-0	RRI	0.5 - 1.5	1.3	1.58	6.5	700	PT 1/4"
HTB-1	RRI	1.5 - 3.0	1.3	1.66	6.5	700	PT 1/4"
HTB-2	RRI	3.0 - 5.0	1.3	1.73	6.5	700	PT 1/4"

Long stroke / Ratchet mechanism

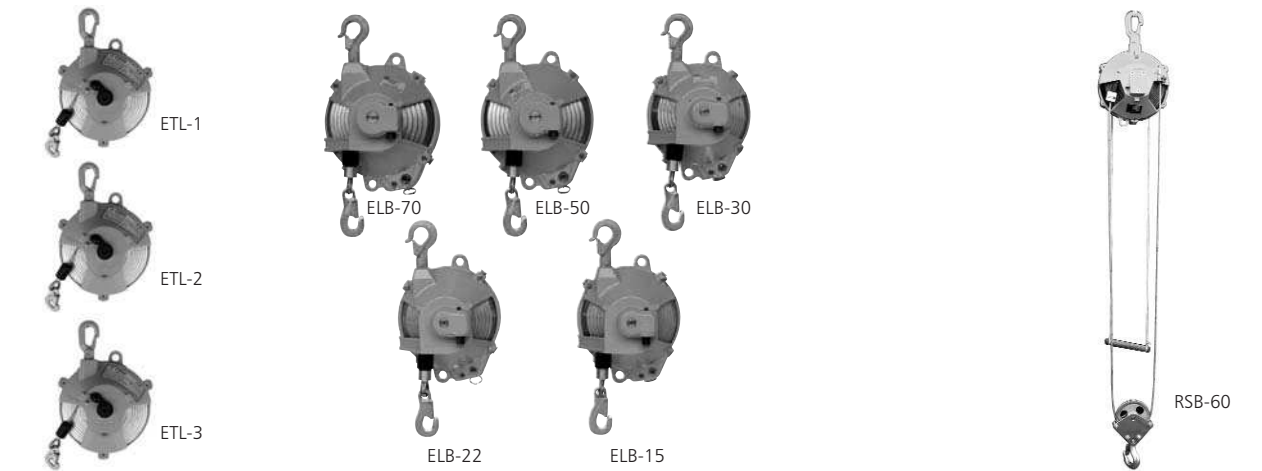

Long stroke

Type	Brand	Capacity kg	Cable length m	Weight kg
ETL-1	RRI	1.5 - 3.0	2.5	4.1
ETL-2	RRI	2.5 - 5.0	2.5	4.2
ETL-3	RRI	5 - 9	2.5	4.7
ELB-15	RRI	9 - 15	2.5	10.0
ELB-22	RRI	15 - 22	2.5	10.2
ELB-30	RRI	22 - 30	2.5	11.0
ELB-40	RRI	30 - 40	2.5	14.0
ELB-50	RRI	40 - 50	2.5	14.5
ELB-60	RRI	50 - 60	2.5	17.0
ELB-70	RRI	60 - 70	2.5	18.0

Ratchet mechanism

RSB-15	RRI	9 - 15	1.5	7.4
RSB-22	RRI	15 - 22	1.5	7.7
RSB-30	RRI	22 - 30	1.5	8.1
RSB-40	RRI	30 - 40	1.5	8.5
RSB-45	RRI	30 - 45	1.0	10.9
RSB-60	RRI	45 - 60	1.0	11.5

In order to support the weight of pneumatic, hydraulic and electric tools, the use of a spring balancer should be considered. The performance of the tools will be speeded up due to good balance and reduced operator fatigue, when using a spring balancer.

Applications

- When heavy tools/machines have to be portable
- Fitting of centre lathe chuck
- Transportation of parts in a production line

Extra safety

- The models ETP, ETL, ELB and TW from TW-9 upwards have a safety mechanism which starts working in case of spring breakage.

Air hoses

Polyurethane

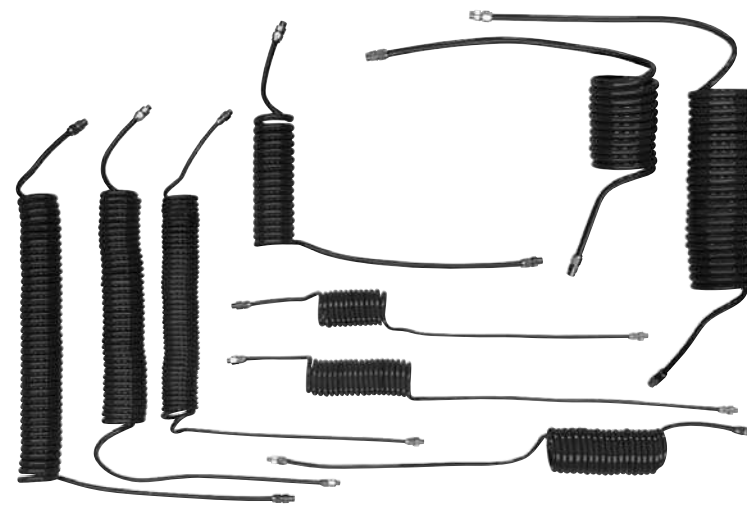

Optimal functioning

Polyurethane air hoses

Type	Brand	Working-length m	Total length m	Inside diameter mm	Outside diameter mm	Joint connection
PT-02510SJ	RR	2	2.5	6.5	9.5	1/4"
PT-02525SJ	RR	4	5	6.5	9.5	1/4"
PT-02550SJ	RR	9	10	6.5	9.5	1/4"
PT-03525SJ	RR	4	5	8	12	1/4"
PT-03550SJ	RR	9	10	8	12	1/4"
PT-04525SJ	RR	4.2	4.7	9.5	13.5	3/8"
PT-04550SJ	RR	9	10	9.5	13.5	3/8"

No kinks after bending!

The hose stretches easily and retracts automatically. This increases productivity and safety.

Features

- Both ends executed with universal swivel-joints
- Provided with straight ends from 10 and 50 cm
- Increased flexibility, no kinks after bending
- Max. pressure 8 bar
- Oil and petrol resistant
- Temperature -20°C to +60°C
- Swivel executed with ballbearings
- Very well suitable for combination with balancers

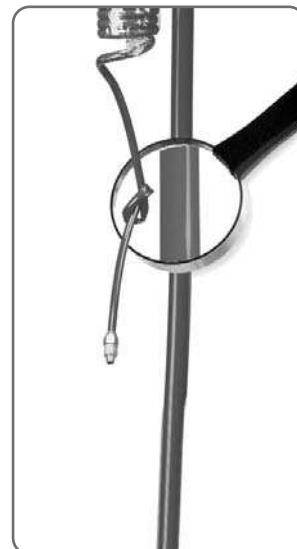

Combi-kit / Various

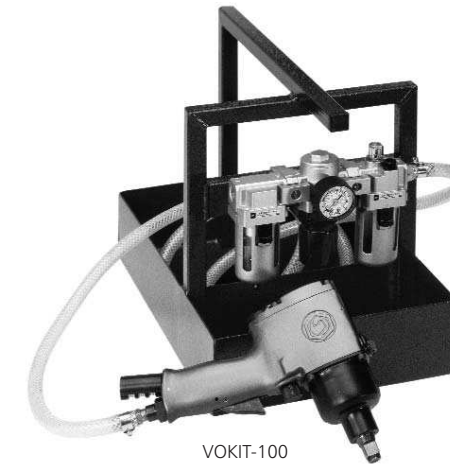

VOKIT-100



8130-1001-00-00

PT-1025

VOKIT-100 Combi-kit

Type	Brand	Description	Height cm	Width cm	Depth cm	Height box cm
VOKIT-100	RR	Combi-kit	40.5	25.5	32	7

Various

Type	Brand	Description	Quantity Liter*	Air consumption l/min	Air pressure max. bar	Inlet-thread
NO32	RR	Lubricating oil	1	-	-	-
NOBP	RR	Oil for impulse wrenches	1	-	-	-
PT-1025	RR	Mini-oiler	-	880	6.3	PT 1/4"
8130-1001-00-00	RR	Regulator	-	-	-	PT 1/8"
8130-1002-00-00	RR	Regulator	-	-	-	PT 1/4"

The combi-kit is a tool carrier complete with SMC filter/regulator/lubricator unit 3/8", type AC30-F03E + pressure gauge.

Yokota NO32 oil is especially developed for the lubrication of air tool systems. The oil increases the life span of your air tools considerable.



NO32 oil

17. Air treatment equipment

Applications

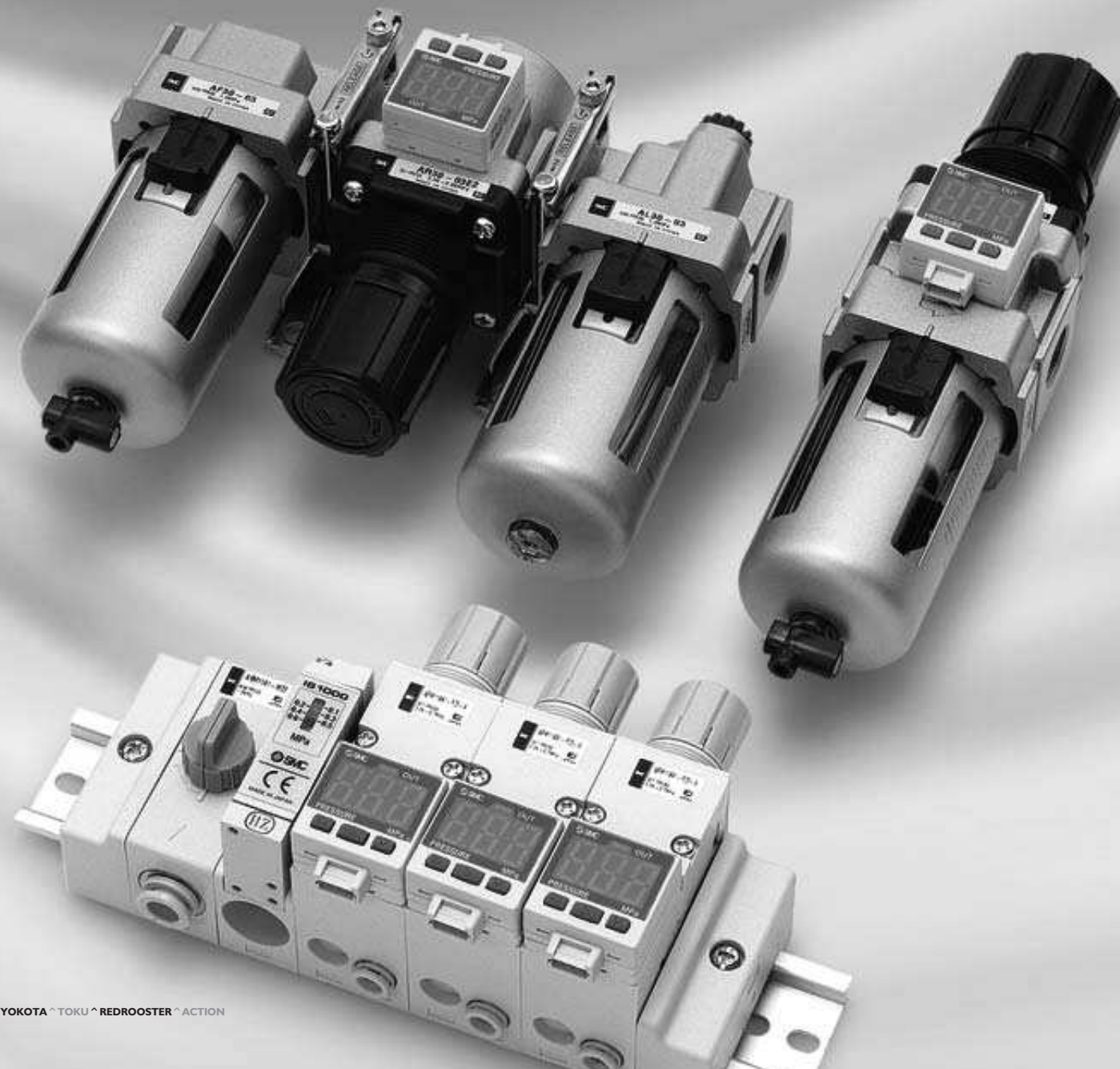

SMC

If the pressure is too low the tool will show less performance and less precision, resulting in slow starting and less productivity. 1 bar pressure reduction means 25% power loss.

Low pressure may occur if:

- The capacity of the compressor is insufficient
- The air piping has been pitched incorrectly
- There are air leaks
- The air treatment equipment is not functioning properly and/or is not pitched correctly
- The wrong size hose nipples or quick couplers are used
- The tank is too small

Waterseparators

With the SMC AMG water separators you can remove easily and cheaply 99% of water droplets. The water separators are compact and light weight. Available port sizes from 1/8" up to 2", therefore suitable for compressors (1-75 kW). Standard equipped with automatic drain for long term jobs.

Filters

The SMC filters have exceptional large air flow and a high rate of filtration. The filters guarantee a high level of the air quality due to separation of condensate by the centrifugal working and filtration of pollution.

Regulators

SMC regulators guarantee a constant secondary pressure, apart from fluctuations in port pressure or pressure decreases.

Lubricators

For precise lubrication of machine components. From series 3.000 oil can be filled under pressure. Easy and precise adjustment. Lubrication already takes place with slight pressure drop.

Air combination sets

Combination sets exist of AF (filter), AR (regulator) and AL (lubricator). Or the AW (filter/regulator combination) and AL (lubricator).

Refrigerated air dryers

The SMC refrigerated air dryer series IDFA removes humidity from your compressed air system and extends thereby the life span of all of your air tools.



Water separators

AMG series



AMG series - water separators

Type	Brand	Compressor kW	NI/min	Port size Rc	Weight kg	Mounting brackets	Filter elements
AMG150-F02C	SMC	2.2	300	1/4"	0.38	BM51	AMG-EL150
AMG250-F03D	SMC	5.5	750	3/8"	0.55	BM52	AMG-EL250
AMG250-F04D	SMC	5.5	750	1/2"	0.55	BM52	AMG-EL250
AMG350-F04D	SMC	11	1.500	1/2"	0.9	BM53	AMG-EL350
AMG350-F06D	SMC	11	1.500	3/4"	0.9	BM53	AMG-EL350
AMG450-F06D	SMC	15	2.200	3/4"	1.4	BM54	AMG-EL450
AMG450-F10D	SMC	15	2.200	1"	1.4	BM54	AMG-EL450
AMG550-F10D	SMC	22	3.500	1"	2.1	BM55	AMG-EL550
AMG650-F14D	SMC	37	6.000	1 1/2"	4.2	BM56	AMG-EL650
AMG850-F20D	SMC	75	12.000	2"	10.5	BM57	AMG-EL850

Working pressure: 1.5 - 10 bar / temperature working area: -5 to 60° C.
Accessories like mounting brackets and filterelements available on request.

You can use a water separator when:

1. Air does not have to be dry for 100%
2. Air dryer cannot be used
3. Air dryer is too expensive for needs

Note Mount filter as far away as possible from the compressor for optimal functioning.

With the SMC water separators you can remove easily and cheaply 99% of water droplets. The water separators are compact and light weight. Available port sizes from 1/8" up to 2", therefore suitable for compressors (1-75 kW). Standard equipped with automatic drain for long term jobs. Long life due to the special resin with large mesh to reduce clogging.

Combination sets

AC series - filter-regulator-lubricator (modular)



AC series - combination of AF (filter), AR (regulator), AL (lubricator) and pressure gauge

Type	Brand	Port size	NI/min	Filter micron	Bowl	Bowl with bajonet connection
AC20-F02E	SMC	1/4"	500	5 μ	Polycarbonate	o
AC30-F03E	SMC	3/8"	2.000	5 μ	Polycarbonate	s
AC40-F03E	SMC	3/8"	4.000	5 μ	Polycarbonate	s
AC40-F04E	SMC	1/2"	4.000	5 μ	Polycarbonate	s
AC40-F06E	SMC	3/4"	4.500	5 μ	Polycarbonate	s
AC50-F06E	SMC	3/4"	5.000	5 μ	Polycarbonate	s
AC50-F10E	SMC	1"	5.000	5 μ	Polycarbonate	s
AC60-F10E	SMC	1"	7.000	5 μ	Polycarbonate	s

o = optional, s = standard
Max. supply pressure: 15 bar / max. working pressure: 10 bar / temperature working area: -5 to 60° C.

AC series - combination of AW (filter/regulator combination), AL (lubricator) and pressure gauge

Type	Brand	Port size	NI/min	Filter micron	Bowl	Bowl with bajonet connection
AC20A-F02E	SMC	1/4"	500	5 μ	Polycarbonate	o
AC30A-F03E	SMC	3/8"	1.700	5 μ	Polycarbonate	s
AC40A-F04E	SMC	1/2"	3.000	5 μ	Polycarbonate	s

o = optional, s = standard
Max. supply pressure: 15 bar / max. working pressure: 10 bar / temperature working area: -5 to 60° C.

On request

- Other combinations
- Automatic drain, normally opened (add CE for E in order number). For good functioning the drain line should have min. 8 mm diam. and should not be longer than 5 m
- Filtration 2, 10, 20, 40, 70, 100 μ
- Metal- or nylon bowls.

Polycarbonate bowls may be damaged and could possibly fail if they are exposed to synthetic oils, thinner solvents, trichloorethylene, kerosene and other aromatic hydrocarbons. If used in above atmosphere, please use a metal bowl (see page 149).

Filters

AF series (modular)



AF

AF series - filters

Type	Brand	Port size	Nl/min	Filter micron	Bowl	Bowl with bajonet connection	Mounting brackets
AF20-F02	SMC	1/4"	750	5 μ	Polycarbonate	o	AF20P-050AS
AF30-F02	SMC	1/4"	1.450	5 μ	Polycarbonate	s	AF30P-050AS
AF30-F03	SMC	3/8"	3.900	5 μ	Polycarbonate	s	AF30P-050AS
AF40-F03	SMC	3/8"	3.900	5 μ	Polycarbonate	s	AF40P-050AS
AF40-F04	SMC	1/2"	3.900	5 μ	Polycarbonate	s	AF40P-050AS
AF40-F06	SMC	3/4"	3.900	5 μ	Polycarbonate	s	AF40P-070AS
AF50-F06	SMC	3/4"	6.500	5 μ	Polycarbonate	s	AF50P-050AS
AF50-F10	SMC	1"	6.500	5 μ	Polycarbonate	s	AF50P-050AS
AF60-F10	SMC	1"	9.800	5 μ	Polycarbonate	s	AF50P-050AS
AF800-12	SMC	1 1/4"	12.000	5 μ	Polycarbonate	s	-
AF800-14	SMC	1 1/2"	12.000	5 μ	Polycarbonate	s	-
AF900-20	SMC	2"	20.000	5 μ	Polycarbonate	s	-

o = optional, s = standard

Max. supply pressure: 15 bar / max. working pressure: 10 bar / temperature working area: -5 to 60° C.

AFM and AFD series (modular)



AFM / AFD

AFM series - microfilters

Type	Brand	Port size	Nl/min	Filter micron	Bowl	Bowl with bajonet connection	Mounting brackets
AFM20-F02	SMC	1/4"	200	0.3 μ	Polycarbonate	o	AF20P-050AS
AFM30-F02	SMC	1/4"	450	0.3 μ	Polycarbonate	s	AF30P-050AS
AFM30-F03	SMC	3/8"	450	0.3 μ	Polycarbonate	s	AF30P-050AS
AFM40-F03	SMC	3/8"	1.100	0.3 μ	Polycarbonate	s	AF40P-050AS
AFM40-F04	SMC	1/2"	1.100	0.3 μ	Polycarbonate	s	AF40P-050AS
AFM40-F06	SMC	3/4"	1.100	0.3 μ	Polycarbonate	s	AF40P-070AS

Max. supply pressure: 15 bar / max. working pressure: 10 bar / temperature working area: -5 to 60° C.

AFD series - submicrofilters

Type	Brand	Port size	Nl/min	Filter micron	Bowl	Bowl with bajonet connection	Mounting brackets
AFD20-F02	SMC	1/4"	120	0.01 μ	Polycarbonate	o	AF20P-050AS
AFD30-F02	SMC	1/4"	240	0.01 μ	Polycarbonate	s	AF30P-050AS
AFD30-F03	SMC	3/8"	240	0.01 μ	Polycarbonate	s	AF30P-050AS
AFD40-F03	SMC	3/8"	600	0.01 μ	Polycarbonate	s	AF40P-050AS
AFD40-F04	SMC	1/2"	600	0.01 μ	Polycarbonate	s	AF40P-050AS
AFD40-F06	SMC	3/4"	600	0.01 μ	Polycarbonate	s	AF40P-070AS

Max. supply pressure: 15 bar / max. working pressure: 10 bar / temperature working area: -5 to 60° C.

On request

- Other combinations
- Automatic drain, normally opened (order number + C). For good functioning the drain line should have min. 8 mm diam. and should not be longer than 5 m
- Filtration 2, 10, 20, 40, 70, 100 μ
- Metal- or nylon bowls.

Polycarbonate bowls may be damaged and could possibly fail if they are exposed to synthetic oils, thinner solvents, trichloorethylene, kerosene and other aromatic hydrocarbons. If used in above atmosphere, please use a metal bowl (see page 149).

On request

- Automatic drain, normally opened (order number + C). For good functioning the drain line should have min. 8 mm diam. and should not be longer than 5 m
- Metal- or nylon bowls.

The microfilters do have an exceptional large air flow and a high rate of filtration. They remove more than 99,9% oil. The filter should be replaced if the decrease of air pressure is 1 bar or more.

Regulators

AR series (modular)



AR

AR series - regulators

Type	Brand	Port size	Nl/min	Port size pressure gauge	Working pressure (bar)	Mounting nut	Mounting brackets
AR20-F02E	SMC	1/4"	500	Integrated	0.5 - 8.5	AR20P-260S	AR20P-270AS*
AR30-F03E	SMC	3/8"	2.800	Integrated	0.5 - 8.5	AR30P-260S	AR30P-270AS*
AR40-F03E	SMC	3/8"	4.300	Integrated	0.5 - 8.5	AR40P-260S	AR40P-270AS*
AR40-F04E	SMC	1/2"	4.300	Integrated	0.5 - 8.5	AR40P-260S	AR40P-270AS*
AR40-F06E	SMC	3/4"	4.300	Integrated	0.5 - 8.5	AR40P-260S	AR40P-270AS*
AR50-F06E	SMC	3/4"	7.000	Integrated	0.5 - 8.5	-	AR50P-270AS**
AR50-F10E	SMC	1"	7.000	Integrated	0.5 - 8.5	-	AR50P-270AS**
AR60-F10E	SMC	1"	9.000	Integrated	0.5 - 8.5	-	AR50P-270AS**
AR825-12	SMC	1 1/4"	14.000	R1/4	0.5 - 8.5	-	-
AR825-14	SMC	1 1/2"	14.000	R1/4	0.5 - 8.5	-	-
AR925-20	SMC	2"	18.000	R1/4	0.5 - 8.5	-	-

* Supplied with mounting nuts

** Supplied with mounting screws

Max. supply pressure: 15 bar / max. working pressure: 10 bar / temperature working area: -5 to 60° C.

AR series - high pressure regulators

AR40-F03-X425	SMC	3/8"	4.500	R1/4	0,5 - 15	AR40P-260S	AR40P-270AS*
AR40-F04-X425	SMC	1/2"	5.000	R1/4	0,5 - 15	AR40P-260S	AR40P-270AS*
AR60-F10-X425	SMC	1"	8.000	R1/4	0,5 - 15	-	AR50P-270AS**

* Supplied with mounting nuts

** Supplied with mounting screws

Max. supply pressure: 30 bar / max. working pressure: 20 bar / temperature working area: -5 to 60° C.

Filter/regulators

AW series (modular)



AW30

AW20

AW series - filter/regulators

Type	Brand	Port size	Nl/min	Port size press. gauge	Working press. (bar)	Filter micron	Bowl	Mounting nut	Bowl with bajonet connection	Mounting brackets
AW20-F02E	SMC	1/4"	500	Integrated	0.5 - 8.5	5 μ	Polycarbonate	AR20P-260S	o	AW20P-270AS*
AW30-F03E	SMC	3/8"	1.550	Integrated	0.5 - 8.5	5 μ	Polycarbonate	AR30P-260S	s	AR30P-270AS*
AW40-F04E	SMC	1/2"	2.800	Integrated	0.5 - 8.5	5 μ	Polycarbonate	AR40P-260S	s	AR40P-270AS*
AW40-F06E	SMC	3/4"	4.000	Integrated	0.5 - 8.5	5 μ	Polycarbonate	AR40P-260S	s	AR40P-270AS*
AW60-F10E	SMC	1"	9.000	Integrated	0.5 - 8.5	5 μ	Polycarbonate	-	s	AW60P-270 AS**

* Supplied with mounting nuts

** Supplied with mounting screws

o = optional, s = standard

Max. supply pressure: 15 bar / max. working pressure: 10 bar / temperature working area: -5 to 60° C.

On request

- Automatic drain, normally opened (add CE for E in order number). For good functioning the drain line should have min. 8 mm diam. and should not be longer than 5 m
- Filtration 2, 10, 20, 40, 70, 100 μ
- Metal- or nylon bowls.

Lubricators

AL series (modular)



AL

AL series - lubricators

Type	Brand	Port size	NI/min	Lubricating from NI/min	Sight dome	Bowl	Bowl with bajonet connection	Mounting brackets
AL20-F02	SMC	1/4"	1.550	15	AL20P-080AS	Polycarbonate	o	AF20P-050AS
AL30-F03	SMC	3/8"	3.100	30	AL20P-080AS	Polycarbonate	s	AF30P-050AS
AL40-F03	SMC	3/8"	7.800	40	AL20P-080AS	Polycarbonate	s	AF40P-050AS
AL40-F04	SMC	1/2"	7.800	40	AL20P-080AS	Polycarbonate	s	AF40P-050AS
AL40-F06	SMC	3/4"	7.800	40	AL20P-080AS	Polycarbonate	s	AF40P-070AS
AL50-F06	SMC	3/4"	10.000	190	AL20P-080AS	Polycarbonate	s	AF50P-050AS
AL50-F10	SMC	1"	10.000	190	AL20P-080AS	Polycarbonate	s	AF50P-050AS
AL60-F10	SMC	1"	14.000	220	AL20P-080AS	Polycarbonate	s	AF50P-050AS
AL800-12	SMC	1 1/4"	18.000	460	12316	Polycarbonate	s	-
AL800-14	SMC	1 1/2"	20.000	650	12316	Polycarbonate	s	-
AL900-20	SMC	2"	25.000	1.800	12316	Polycarbonate	s	-

o = optional, s = standard

Max. supply pressure: 15 bar / max. working pressure: 10 bar / temperature working area: -5 to 60° C

Recommended oil norm: ISO VG32

Accessories

Spacers / Brackets



Y100 spacer



Y100 spacer with bracket



Y110-M5 T-interface



E100-M5 piping adapter

Spacers and brackets

For series	Brand	Port size	Piping adaptors	Spacer	Spacer with bracket	T-interface	Piping adapter
10	SMC	M5	E100-M5	Y100	Y100T	Y110-M5	E100-M5
20	SMC	1/4"	E200-F02	Y200	Y200T	Y210-02	E200-F02
30	SMC	3/8"	E300-F02	Y300	Y300T	Y310-02	E300-F03
40	SMC	1/2"	E400-F04	Y400	Y400T	Y410-03	E400-F04
40	SMC	3/4"	E400-F06	Y500	Y500T	Y-510-03	E500-F06
50	SMC	3/4"	E600-F06	Y600	Y600T	Y610-04	E500-F06
50	SMC	1"	E600-F10	Y600	Y600T	Y610-04	E500-F06
60	SMC	3/4"	E600-F06	Y600	Y600T	Y610-04	E500-F06
60	SMC	1"	E600-F10	Y600	Y600T	Y610-04	E500-F10

Piping adaptors for easy installation and maintenance.

Spacers for mounting the combination without wall connection.

Spacers with T-type bracket for wall mounting the modular unit, equipped with T-type bracket.

Mounting brackets for mounting separate components.

Various

Bowls



Type	Brand	For series	Port size	Operation	Nl/min	Silencer	Working pressure (bar)	Diameter mm
------	-------	------------	-----------	-----------	--------	----------	------------------------	-------------

EAD series - automatic condensate drains

EAD202-F02	SMC	-	1/4"	Pneumatic	-	-	-	-
EAD202-F03	SMC	-	3/8"	Pneumatic	-	-	-	-
EAD402-F04	SMC	-	1/2"	Pneumatic	-	-	-	-
EAD600-F10	SMC	-	1"	Pneumatic	-	-	-	-
ADH4000-F04	SMC	-	1/2"	Pneumatic	-	-	-	-
ADM200-045	SMC	-	1/2"	Electric (220V)	-	-	-	-

AKM series - T-type spacers with check valve

AKM2000-F02	SMC	20	1/4"	-	750	-	-	-
AKM3000-F02	SMC	30	3/8"	-	1.700	-	-	-
AKM4000-F03	SMC	40	1/2"	-	3.150	-	-	-

VHS series - shut-off valves

VHS20-F02	SMC	20	1/4"	-	750	AN103-01	-	-
VHS30-F03	SMC	30	3/8"	-	1.700	AN200-02	-	-
VHS40-F04	SMC	40	1/2"	-	3.150	AN300-03	-	-

AN series - silencers

AN103-01	SMC	-	1/8"	-	-	-	-	-
AN200-02	SMC	-	1/4"	-	-	-	-	-
AN300-03	SMC	-	3/8"	-	-	-	-	-
AN400-04	SMC	-	1/2"	-	-	-	-	-
AN500-05	SMC	-	3/4"	-	-	-	-	-
AN600-10	SMC	-	1"	-	-	-	-	-
AN700-12	SMC	-	1 1/4"	-	-	-	-	-
AN800-14	SMC	-	1 1/2"	-	-	-	-	-

K series - pressure gauges

K16-10-26	SMC	10	1/16"	-	-	-	0 - 10	26
K8-10-40	SMC	20/30	1/8"	-	-	-	0 - 10	40
K4-10-50	SMC	40/50/60	1/4"	-	-	-	0 - 10	50

ISE35 series - integrated pressure gauges with pressure switch and cable

Type	Brand	For series	Power supply	Cable length m	Protection degree	Display	Set pressure range	Output
ISE35-N-65-LA	SMC	20/30/40/50/60	12 - 24V DC	2	IP40	LED 2-colors	-0.1 - 10	NPN
ISE35-N-25-LA	SMC	20/30/40/50/60	12 - 24V DC	2	IP40	LED 2-colors	-0.1 - 10	PNP

For the FRL series



C2SL / C2SF

Bowls for the FRL series

For series	Brand	For lubricator	For filter	Polycarbonate	Nylon	Metal	Automatic drain	O-Rings
10	SMC	C1SL	C1SF	*				C1SFP-260S
			-		*			
20	SMC	C2SL	AD17	*		*	*	C2SFP-260S
			C2SF	*				
			C25F-6		*			
			C25F-2			*		
30	SMC	C3SL	AD27	*			*	C3SFP-260S
			C3SF	*		*		
			C35F-6		*			
			C35F-2			*		
40	SMC	C4SL	AD37	*			*	C4SFP-260S
			C4SF	*				
			C45F-6		*			
			C45F-2			*		
50	SMC	C4SL	AD47	*			*	C4SFP-260S
			C4SF	*		*		
			C45F-6		*			
			C45F-2			*		
60	SMC	C4SL	AD47	*			*	C4SFP-260S
			C4SF	*		*		
			C45F-6		*			
			C45F-2			*		
			AD47	*		*		

Polycarbonate bowls may be damaged and could possibly fail if they are exposed to synthetic oils, thinner solvents, trichloroethylene, kerosene and other aromatic hydrocarbons. If used in above atmosphere, please use a metal bowl.

Refrigerated air dryer

IDFA series

The new SMC IDFA series of refrigerated air dryers are the result of over 40 years of experience combined with the latest compressed air and refrigeration technology. Built to international standards and backed by SMC's BS en ISO 9001 quality certification, the new IDFA series has nine standard models with nominal capacities ranging from 34 - 822 m³/h.

Series IDFA Refrigerated Air Dryer

- State of the art design ensures a constant +3° C pressure dew point
- High efficiency heat exchanger
- Environmentally ozone friendly refrigerants
- Conforms to stringent ISO8573-1 standards
- Simple control system with easy to read evaporator gauge
- Compact design for easy installation
- High performance, reliable and trouble free



IDFA series - standard specifications

Type	Brand	Inlet air-- pressure (bar)	Inlet air- temp. (°C)	Ambient temp. (°C) *	Power supply voltage	Power cons. (W)	Air port connections	Refrigerant	Weight kg
IDFA4E-23	SMC	1.5 - 10	5 - 50	2 - 40	1 Phase 230V AC 50Hz	180	Rc 1/2	R134a	22
IDFA6E-23-K	SMC	1.5 - 16	5 - 50	2 - 40	1 Phase 230V AC 50Hz	180	Rc 3/4	R134a	23
IDFA8E-23-K	SMC	1.5 - 16	5 - 50	2 - 40	1 Phase 230V AC 50Hz	208	Rc 3/4	R134a	27
IDFA11E-23-K	SMC	1.5 - 16	5 - 50	2 - 40	1 Phase 230V AC 50Hz	385	Rc 3/4	R134a	28
IDFA15E-23-K	SMC	1.5 - 16	5 - 50	2 - 40	1 Phase 230V AC 50Hz	470	Rc 1	R134a	46
IDFA22E-23-K	SMC	1.5 - 16	5 - 50	2 - 40	1 Phase 230V AC 50Hz	760	R 1	R407C	54
IDFA37E-23-K	SMC	1.5 - 16	5 - 50	2 - 40	1 Phase 230V AC 50Hz	760	R 1 1/2	R407C	62
IDFA55E-23-L	SMC	1.5 - 16	5 - 50	2 - 40	1 Phase 230V AC 50Hz	1130	R 2	R407C	100
IDFA75E-23-L	SMC	1.5 - 16	5 - 50	2 - 40	1 Phase 230V AC 50Hz	1700	R 2	R407C	116

Note Thread adapters to convert Rc thread to R thread are included with IDFA4E to IDFA15E.

IDFA series - nominal air flow rate [m³/h (ANR)]*

Type	Brand	3°C Pressure dew point	7°C Pressure dew point	10°C Pressure dew point
IDFA4E-23	SMC	24	31	34
IDFA6E-23-K	SMC	36	46	50
IDFA8E-23-K	SMC	65	83	91
IDFA11E-23-K	SMC	80	101	112
IDFA15E-23-K	SMC	120	152	168
IDFA22E-23-K	SMC	182	231	254
IDFA37E-23-K	SMC	273	347	382
IDFA55E-23-L	SMC	390	432	510
IDFA75E-23-L	SMC	660	720	822

* Standard condition (ANR) with 20°C ambient temperature, atmospheric pressure and relative humidity of 65%. Performance data for pressure dew point in accordance with operating conditions from ISO7183 (P₁= 7 bar, T₁= 35°C (saturated), Cooling air temp. 25°C).

Operating principle / Dimensions

Operation principle IDFA refrigerated air dryer

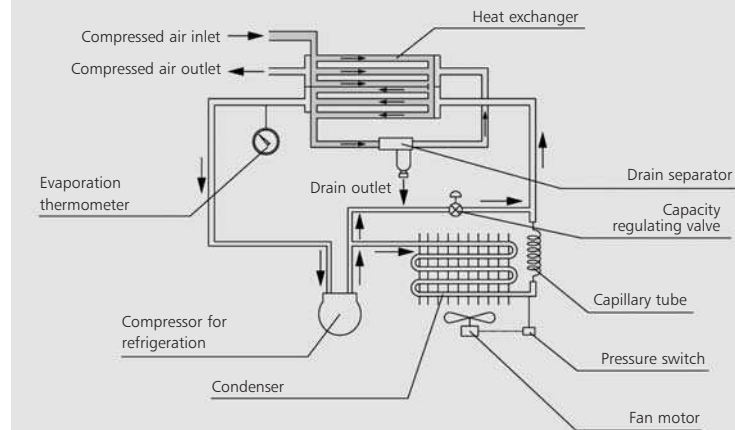

Saturated compressed air enters the air-to-air heat exchanger. The incoming air is then pre-cooled by the cold air exiting the dryer. The air then passes through the evaporator, where it is further cooled to a 3° C dew point. As the air cools, the water condenses to liquid which is removed by the automatic drain. The dry air is then passed back through the air-to-air heat exchanger where it is reheated before leaving the dryer.

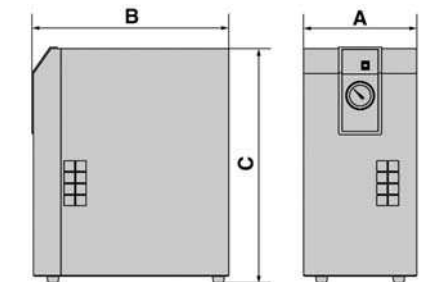

Dimensions IDFA series

Type	A	B	C
IDFA4E-23	270	453	498
IDFA6E-23-K	270	455	498
IDFA8E-23-K	270	485	568
IDFA11E-23-K	270	485	568
IDFA15E-23-K	300	603	578
IDFA22E-23-K	290	775	623
IDFA37E-23-K	290	855	623
IDFA55E-23-L	470	855	800
IDFA75E-23-L	470	855	900

Banish moisture in your compressed air

Tests carried out by SMC, world leaders in pneumatic technology, have indicated that in certain atmospheric conditions the moisture contained in compressed air from a 75 kW compressor after one days operation could be equivalent to 113 litres of water.

Obviously any compressed air system containing this volume of air moisture will suffer from dramatically reduced valve and air cylinder per-

formance. Therefore armed with this knowledge, SMC's R&D engineers have now produced the perfect answer with their new range of Refrigerated Air Dryers - Series IDFA.

Designed specifically for the European market, with both CE accreditation and 230VAC (50Hz) voltage requirements, Series IDFA effectively removes water vapour through a highly efficient stainless steel, improved corrosion resistant, heat exchanger. With eight flow rate sized options - 34 to 822 m³/h (ANR), these new air dryers use ozone friendly HFC refri-

gerants - R134a / R407C - and emit outlet air at 3°C pressure point as per the ISO8573-1 standard.

Incorporating an easy to see evaporation temperature gauge, to confirm correct operation, Series IDFA is highly efficient with a low pressure drop when operating for improved energy savings.

IDFA series - correction factors

Inlet air temp. (°C)		5-25°	30°	35°	40°	45°	50°									
Correction factor A		1.30	1.25	1.00	0.83	0.70	0.60									
Ambient temp. (°C)		20°	25°	30°	35°	40°										
Correction factor B		IDFA3E - IDFA11E	1.10	1.00	0.91	0.83	0.79									
		IDFA15E - IDFA37E	1.10	1	0.97	0.89	0.77									
Inlet air press. (bar)		3	4	5	6	7	8	9	10	11	12	13	14	15	16	
Correction factor C		IDFA3E - IDFA11E	0.80	0.87	0.92	0.96	1.00	1.04	1.07	1.10	1.13	1.16	1.18	1.21	1.23	1.25
		IDFA15E - IDFA37E	0.72	0.81	0.88	0.95	1.00	1.06	1.11	1.16	1.19	1.21	1.23	1.25	1.26	1.27

Corrected air flow rate [m³/h] = Customers air flow rate / (factor A x factor B x factor C)

18. Impact sockets

Applications

Action

If you work with impact wrenches we advise you to use the right impact socket with your specific tool in order to achieve the best result and the highest safety during the job. Also extension bars, Adapters and universal joints are available.

Surface Drive Sockets are used in places where fast assembling is required. The easy and fast fitting of the socket on the bolt makes it possible to put the socket on the bolt with a running tool and to make the joint.

Sleeve Drive Sockets have been developed by Action at the request of Yokota to improve the quality of a joint tightening with impulse wrenches. *Sleeve Drive Sockets minimize play between socket and tool thus reducing "wobble" and stabilizing the torque setting.* The use of Sleeve Drive Sockets is not only of benefit to the actual joint but also reduces vibration to the tool and operator, also reducing noise levels and tool wear.

All Action impact sockets are manufactured according to DIN 3121 and DIN 3129. Universal joints and thin wall sockets are supplied without warranty.

Worn sockets cause loss of power and wear to the square drive of the tool increases vibration to the operator. Replace your worn sockets in time.

Impact sockets

1/4"

1/4" Impact sockets - normal ①

Type	A/F mm/inch	Drawing	D1 mm	D2 mm	L mm	L2 mm
<i>Metrical</i>						
D00014-0-004	4	A	7.6	13	23	4
D00014-0-0045	4.5	A	8.2	13	23	5
D00014-0-005	5	A	8.8	13	23	5
D00014-0-0055	5.5	A	9.5	13	23	5
D00014-0-006	6	A	10	13	23	6
D00014-0-007	7	A	11.3	13	23	6
D00014-0-008	8	A	12.5	13	23	7
D00014-0-009	9	A	13.8	13	23	7
D00014-0-010	10	C	15	13	23	7
D00014-0-011	11	C	16.3	13	23	8
D00014-0-012	12	C	17	13	23	8
D00014-0-013	13	C	18.8	13	23	8
D00014-0-014	14	C	20	13	23	8
D00014-0-015	15	C	21	13	23	8

Inch

Type	A/F mm/inch	Drawing	D1 mm	D2 mm	L mm	L2 mm
D00014-0-3/16	3/16"	A	8.5	13	23	5
D00014-0-1/4	1/4"	A	10.3	13	23	6
D00014-0-5/16	5/16"	A	12.5	13	23	7
D00014-0-3/8	3/8"	C	15	13	23	7
D00014-0-7/16	7/16"	C	16.3	13	23	8
D00014-0-1/2	1/2"	C	18.8	13	23	8

1/4" Impact sockets - long ②

Type	A/F mm	Drawing	D1 mm	D2 mm	L mm	L2 mm
<i>Metrical</i>						
D00014-1-010	10	C	15	13	50	9
D00014-1-013	13	C	18.8	13	50	9
D00014-1-015	15	C	21	13	50	9

1/4" Magnetic impact sockets - normal ③

Type	A/F mm	Drawing	D1 mm	D2 mm	L mm	L2 mm
<i>Metrical</i>						
D06050P050	5	A	8.8	13	23	3
D06050P055	5.5	A	9.5	13	23	3
D06050P060	6	A	10	13	23	3
D06050P070	7	A	11.3	13	23	3
D06050P080	8	A	12.5	13	23	3
D06050P090	9	C	13.8	13	23	4
D06050P100	10	C	15	13	23	4
D06050P110	11	C	16.3	13	23	5
D06050P120	12	C	17	13	23	5
D06050P130	13	C	18.8	13	23	5
D06050P140	14	C	20	13	23	6
D06050P150	15	C	21	13	23	6

1/4" Magnetical impact sockets - long ④

Type	A/F mm	Drawing	D1 mm	D2 mm	L mm	L2 mm
<i>Metrical</i>						
D06050R050	5	A	8.8	13	50	3
D06050R055	5.5	A	9.5	13	50	3
D06050R060	6	A	10	13	50	3
D06050R070	7	A	11.3	13	50	3
D06050R080	8	A	12.5	13	50	3
D06050R090	9	C	13.8	13	50	4
D06050R100	10	C	15	13	50	4
D06050R110	11	C	16.3	13	50	5
D06050R120	12	C	17	13	50	5
D06050R130	13	C	18.8	13	50	5
D06050R140	14	C	20	13	50	6
D06050R150	15	C	21	13	50	6

1/4"

1/4" Surface Drive impact sockets - normal ①

Type	A/F mm	Drawing	D1 mm	D2 mm	L mm	L2 mm
<i>Metrical</i>						
D063405040	4	A	7.6	13	23	4
D063405045	4.5	A	8.2	13	23	5
D063405050	5	A	8.8	13	23	5
D063405055	5.5	A	9.5	13	23	5
D063405060	6	A	10	13	23	6
D063405070	7	A	11.3	13	23	6
D063405080	8	A	12.5	13	23	7
D063405090	9	C	13.8	13	23	7
D063405100	10	C	15	13	23	7
D063405110	11	C	16.3	13	23	8
D063405120	12	C	17	13	23	8
D063405130	13	C	18.8	13	23	8
D063405140	14	C	20	13	23	8
D063405150	15	C	21	13	23	8

1/4" Surface Drive impact sockets - long ②

Type	A/F mm	Drawing	D1 mm	D2 mm	L mm	L2 mm
<i>Metrical</i>						
D063407040	4	A	7.6	13	50	4
D063407045	4.5	A	8.2	13	50	6
D063407050	5	A	8.8	13	50	6
D063407055	5.5	A	9.5	13	50	6
D063407060	6	A	10	13	50	7
D063407070	7	A	11.3	13	50	7
D063407080	8	A	12.5	13	50	9
D063407090	9	C	13.8	13	50	9
D063407100	10	C	15	13	50	9
D063407110	11	C	16.3	13	50	9
D063407120	12	C	17	13	50	9
D063407130	13	C	18.8	13	50	9
D063407140	14	C	20	13	50	9
D063407150	15	C	21	13	50	9

1/4" Torx® impact sockets - external ③

Type	A/F mm	Drawing	D1 mm	D2 mm	L mm	L2 mm
<i>Metrical</i>						
D063300004	E4	A	7.2	13	25	4
D063300005	E5	A	8	13	25	4.5
D063300006	E6	A	9	13	25	5
D063300007	E7	A	9.5	13	25	6
D063300008	E8	A	10	13	25	6
D063300010	E10	A	12.5	13	25	7.5
D063300011	E11	B	13	13	25	8
D063300012	E12	B	14.5	14.5	25	8.5

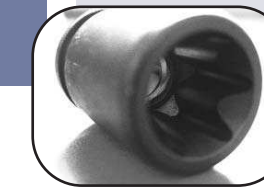

Torx® impact sockets



Surface Drive impact sockets

1/4" Torx® impact sockets, thin wall- external ④

Type	A/F mm	Drawing	D1 mm	D2 mm	L mm	L2 mm
<i>Metrical</i>						
D063305004	E4	A	6.5	13	25	4
D063305005	E5	A	7.5	13	25	4.5
D063305006	E6	A	8.5	13	25	5
D063305007	E7	A	9	13	25	6
D063305008	E8	A	9.8	13	25	6
D063305010	E10	A	12	13	25	6.5
D063305011	E11	A	12.7	13	25	8
D063305012	E12	A	14	14.5	25	8.5

1/4" Torx® impact sockets - internal ⑤

Type	A/F mm	Drawing	D2 mm	L1 mm	L mm
<i>Metrical</i>					
D064701005	T5	F	13	2.0	35
D064701006	T6	F	13	2.0	35
D064701007	T7	F	13	2.0	35
D064701008	T8	F	13	2.0	35
D064701009	T9	F	13	2.0	35
D064701010	T10	F	13	2.8	35
D064701015	T15	F	13	2.8	35
D064701020	T20	F	13	2.8	35
D064701025	T25	F	13	3.0	35
D064701027	T27	F	13	3.0	35
D064701030	T30	F	13	3.8	35

1/4" Torx® Tamper Resistant impact sockets - internal ⑥

Type	A/F mm	Drawing	D2 mm	L1 mm	L mm
<i>Metrical</i>					
D064706008	T5	F	13	2.0	35
D064706009	T6	F	13	2.0	35
D064706010	T7	F	13	2.0	35
D064706015	T8	F	13	2.0	35
D064706020	T9	F	13	2.0	35
D064706025	T10	F	13	2.8	35
D064706027	T15	F	13	2.8	35
D064706030	T20	F	13	2.8	35

Torx® is a trademark of Textron.

1/4" Pin and ring

D01014-0-000 1/4"

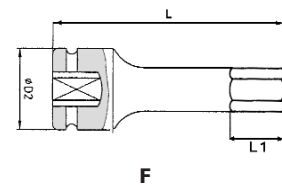
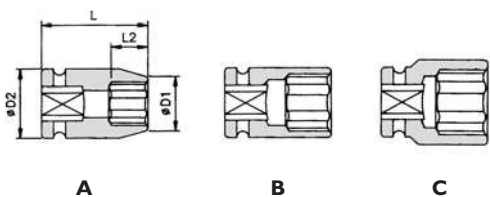

Impact sockets

1/4" + 3/8"

1/4" Universal joint sockets - normal ①

Type	A/F mm	Drawing	D1 mm	D2 mm	L mm	L2 mm
<i>Metrical</i>						
DO62500050	5	E	8.8	15	43	5
DO62500055	5.5	E	9.5	15	43	6
DO62500060	6	E	10	15	43	6
DO62500070	7	E	11.5	15	43	8
DO62500080	8	E	12.5	15	43	8
DO62500090	9	E	14	15	43	8
DO62500100	10	E	15	15	43	8
DO62500110	11	E	16.5	15	43	8
DO62500120	12	E	16.8	16	48	8
DO62500130	13	E	18.8	16	48	8
DO62500140	14	E	19.8	16	48	8
DO62500150	15	E	20.8	16	48	8

3/8" Impact sockets - normal ②

Type	A/F mm	Drawing	D1 mm	D2 mm	L mm	L2 mm
<i>Metrical</i>						
DO1038-0-006	6	A	11	19	30	4
DO1038-0-007	7	A	12.5	19	30	8
DO1038-0-008	8	A	14	19	30	8
DO1038-0-009	9	A	15	19	30	8
DO1038-0-010	10	A	16	19	30	8
DO1038-0-011	11	A	17.5	19	30	9
DO1038-0-012	12	B	19	19	30	9
DO1038-0-013	13	A	20	22	30	9
DO1038-0-014	14	A	21	22	30	9
DO1038-0-015	15	B	22	22	30	11
DO1038-0-016	16	C	24	22	30	11
DO1038-0-017	17	C	25	22	30	11
DO1038-0-018	18	C	26	22	30	11
DO1038-0-019	19	C	27.5	22	30	11
DO1038-0-020	20	C	28	22	30	12
DO1038-0-021	21	C	30	22	30	13
DO1038-0-022	22	C	32	23	30	13
DO1038-0-024	24	C	34	23	30	13

3/8" Impact sockets - normal ③

Type	A/F Zoll	Drawing	D1 mm	D2 mm	L mm	L2 mm
<i>Inch</i>						
DO1038-0-5/16	5/16"	A	12.5	19	30	8
DO1038-0-3/8	3/8"	A	14.5	19	30	8
DO1038-0-7/16	7/16"	A	17	19	30	9
DO1038-0-1/2	1/2"	B	19	19	30	9
DO1038-0-9/16	9/16"	B	20	20	30	9
DO1038-0-5/8	5/8"	B	24	24	30	11
DO1038-0-11/16	11/16"	B	24	24	30	11
DO1038-0-3/4	3/4"	B	26	26	30	11
DO1038-0-13/16	13/16"	B	28	28	30	13
DO1038-0-7/8	7/8"	B	30	30	30	13
DO1038-0-15/16	15/16"	B	34	34	30	13

3/8" Impact sockets - long ④

Type	A/F mm	Drawing	D1 mm	D2 mm	L mm	L2 mm
<i>Metrical</i>						
DO1038-1-007	7	A	12.5	19	65	12
DO1038-1-008	8	A	13.8	19	65	12
DO1038-1-009	9	A	15	19	65	12
DO1038-1-010	10	A	16	19	65	12
DO1038-1-011	11	A	17.5	19	65	25
DO1038-1-012	12	B	19	19	65	25
DO1038-1-013	13	A	20	22	65	25
DO1038-1-014	14	A	21	22	65	25
DO1038-1-015	15	B	22	22	65	25
DO1038-1-016	16	C	24	22	65	25
DO1038-1-017	17	C	25	22	65	25
DO1038-1-018	18	C	26	22	65	25
DO1038-1-019	19	C	27.5	22	65	25
DO1038-1-020	20	C	28	22	65	25
DO1038-1-021	21	C	30	22	65	25
DO1038-1-022	22	C	32	23	65	25
DO1038-1-024	24	C	34	23	65	25



3/8"

3/8" Magnetical impact sockets - normal ①

Type	A/F mm	Drawing	D1 mm	D2 mm	L mm	L2 mm
<i>Metrical</i>						
DO6051P006	6	A	11.5	19	30	3
DO6051P007	7	A	12.5	19	30	3
DO6051P008	8	A	14	19	30	3
DO6051P009	9	A	15	19	30	4
DO6051P010	10	A	16.5	19	30	4
DO6051P011	11	A	17.5	19	30	5
DO6051P012	12	B	19	19	30	5
DO6051P013	13	A	20	22	30	5
DO6051P014	14	A	21.5	22	30	6
DO6051P015	15	B	22	22	30	6
DO6051P016	16	C	24	22	30	6
DO6051P017	17	C	25	22	30	6
DO6051P018	18	C	26	22	30	7
DO6051P019	19	C	27.5	22	30	7

3/8" Magnetical impact sockets - long ②

Type	A/F mm	Drawing	D1 mm	D2 mm	L mm	L2 mm
<i>Metrical</i>						
DO6051R006	6	A	11.5	19	55	3
DO6051R007	7	A	12.5	19	55	3
DO6051R008	8	A	14	19	55	3
DO6051R009	9	A	15	19	55	4
DO6051R010	10	A	16.5	19	55	4
DO6051R011	11	A	17.5	19	55	5
DO6051R012	12	B	19	19	55	5
DO6051R013	13	A	20	22	55	5
DO6051R014	14	A	21.5	22	55	6
DO6051R015	15	B	22	22	55	6
DO6051R016	16	C	24	22	55	6
DO6051R017	17	C	25	22	55	6
DO6051R018	18	C	26	22	55	7
DO6051R019	19	C	27.5	22	55	7

3/8" Impact sockets - 12-point - normal ③

Type	A/F mm	Drawing	D1 mm	D2 mm	L mm	L2 mm
<i>Metrical</i>						
DO65815006	6	A	11	19	30	5
DO65815007	7	A	12	19	30	8
DO65815008	8	A	13	19	30	8
DO65815009	9	A	15	19	30	8
DO65815010	10	A	16	19	30	8
DO65815011	11	A	17.5	19	30	9
DO65815012	12	A	18.5	19	30	9
DO65815013	13	A	20	22	30	10
DO65815014	14	A	21	22	30	11
DO65815015	15	B	22	22	30	12
DO65815016	16	C	24	22	30	12
DO65815017	17	C	25	22	30	12
DO65815018	18	C	26	22	30	13
DO65815019	19	C	27	22	30	13
DO65815020	20	C	28	22	30	13
DO65815021	21	C	30	22	30	14
DO65815022	22	C	31	23	30	15
DO65815023	23	C	32	23	30	15
DO65815024	24	C	34	23	30	16
DO65815025	25	C	35	23	30	16
DO65815026	26	C	36	23	30	16

3/8" Impact sockets - 12-point - long ④

Type	A/F mm	Drawing	D1 mm	D2 mm	L mm	L2 mm
<i>Metrical</i>						
DO65817006	6	A	11	19	63	5
DO65817007	7	A	12	19	63	12
DO65817008	8	A	13	19	63	12
DO65817009	9	A	15	19	65	12
DO65817010	10	A	16	19	65	22
DO65817011	11	A	17.5	19	65	22
DO65817012	12	A	18.5	19	65	22
DO65817013	13	A	20	22	65	22
DO65817014	14	A	21	22	65	22
DO65817015	15	B	22	22	65	22
DO65817016	16	C	24	22	65	24
DO65817017	17	C	25	22	65	24
DO65817018	18	C	26	22	65	24
DO65817019	19	C	27	22	65	24
DO65817020	20	C	28	22	65	24
DO65817021	21	C	30	22	65	24
DO65817022	22	C	31	23	65	24
DO65817023	23	C	32	23	65	24
DO65817024	24	C	34	23	65	24
DO65817025	25	C	35	23	65	24
DO65817026	26	C	36	23	65	24

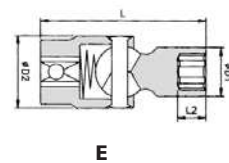
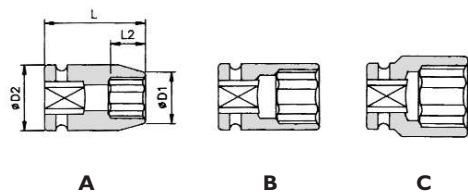

Impact sockets

3/8"

3/8" Impact sockets - L = 150 ①

Type	A/F mm	Drawing	D1 mm	D2 mm	L mm	L2 mm
<i>Metrical</i>						
DO60715006	6	G	1	22	150	4
DO60715008	8	G	12.5	22	150	8
DO60715010	10	G	15.5	22	150	8
DO60715012	12	G	18	22	150	9
DO60715013	13	G	19.5	22	150	9
DO60715014	14	G	20.5	22	150	9
DO60715015	15	G	21	22	150	11
DO60715016	16	G	22.5	22	150	11
DO60715017	17	G	24	22	150	11

3/8" Impact sockets - L = 200 ②

Type	A/F mm	Drawing	D1 mm	D2 mm	L mm	L2 mm
<i>Metrical</i>						
DO60716006	6	G	1	22	200	4
DO60716008	8	G	12.5	22	200	8
DO60716010	10	G	15.5	22	200	8
DO60716012	12	G	18	22	200	9
DO60716013	13	G	19.5	22	200	9
DO60716014	14	G	20.5	22	200	9
DO60716015	15	G	21	22	200	11
DO60716016	16	G	22.5	22	200	11
DO60716017	17	G	24	22	200	11

3/8" Impact sockets - L = 250 ③

Type	A/F mm	Drawing	D1 mm	D2 mm	L mm	L2 mm
<i>Metrical</i>						
DO60717006	6	G	1	22	250	4
DO60717008	8	G	12.5	22	250	8
DO60717010	10	G	15.5	22	250	8
DO60717012	12	G	18	22	250	9
DO60717013	13	G	19.5	22	250	9
DO60717014	14	G	20.5	22	250	9
DO60717015	15	G	21	22	250	11
DO60717016	16	G	22.5	22	250	11
DO60717017	17	G	24	22	250	11

3/8" Surface Drive impact sockets - normal ④

Type	A/F mm/inch	Drawing	D1 mm	D2 mm	L mm	L2 mm
<i>Metrical</i>						
DO63415008	8	A	13.8	19	32	8
DO63415009	9	A	15	19	32	8
DO63415010	10	A	16	19	32	8
DO63415011	11	A	17.5	19	32	9
DO63415012	12	B	19	19	32	9
DO63415013	13	A	20	22	32	9
DO63415014	14	B	22	22	32	9
DO63415015	15	B	22	22	32	11
DO63415016	16	C	24	22	32	11
DO63415017	17	C	25	22	32	11
DO63415018	18	C	26	22	32	11
DO63415019	19	C	28	22	32	11

Inch

DO63410008	1/4"	A	11.5	19	32	4
DO63410010	5/16"	A	13.8	19	32	8
DO63410012	3/8"	A	15.5	19	32	8
DO63410014	7/16"	A	17.5	19	32	9
DO63410016	1/2"	A	20	22	32	9
DO63410018	9/16"	B	22	22	32	11
DO63410020	5/8"	C	24	22	32	11
DO63410022	11/16"	C	26	22	32	11
DO63410024	3/4"	C	28	22	32	11

3/8" Torx® impact sockets - external ⑤

Type	A/F mm	Drawing	D1 mm	D2 mm	L mm	L2 mm
<i>Metrical</i>						
DO63310005	E5	A	9	19	32	4.5
DO63310006	E6	A	10	19	32	5
DO63310007	E7	A	10	19	32	6
DO63310008	E8	A	10.5	19	32	6
DO63310010	E10	A	12.5	19	32	7.5
DO63310011	E11	A	14.5	19	32	8
DO63310012	E12	A	15	19	32	8.5
DO63310014	E14	A	17.5	19	32	10
DO63310016	E16	B	19	19	32	11

Torx® is a trademark of Textron.

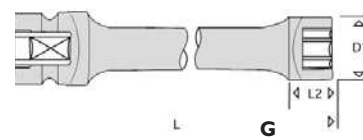
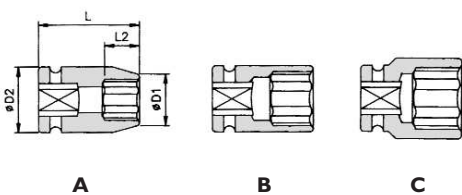

3/8"

3/8" Surface Drive impact sockets - long ①

Type	A/F mm/inch	Drawing	D1 mm	D2 mm	L mm	L2 mm
<i>Metrical</i>						
DO63417008	8	A	13.8	19	80	12
DO63417009	9	A	15	19	80	12
DO63417010	10	A	16	19	80	12
DO63417011	11	A	17.5	19	80	25
DO63417012	12	B	19	19	80	25
DO63417013	13	A	20	22	80	25
DO63417014	14	B	22	22	80	25
DO63417015	15	B	22	22	80	25
DO63417016	16	C	24	22	80	25
DO63417017	17	C	25	22	80	25
DO63417018	18	C	26	22	80	25
DO63417019	19	C	28	22	80	25

Inch

DO63412010	5/16"	A	13.8	19	80	12
DO63412012	3/8"	A	15.5	19	80	12
DO63412014	7/16"	A	17.5	19	80	25
DO63412016	1/2"	A	20	22	80	25
DO63412018	9/16"	B	22	22	80	25
DO63412020	5/8"	C	24	22	80	25
DO63412022	11/16"	C	26	22	80	25
DO63412024	3/4"	C	28	22	80	25

3/8" Torx® impact sockets, thin wall- external ②

Type	A/F mm	Drawing	D1 mm	D2 mm	L mm	L2 mm
<i>Metrical</i>						
DO63315005	E5	A	8	19	32	4.5
DO63315006	E6	A	9	19	32	5
DO63315007	E7	A	9.3	19	32	6
DO63315008	E8	A	10	19	32	6
DO63315010	E10	A	12.3	19	32	7.5
DO63315011	E11	A	13	19	32	8
DO63315012	E12	A	14	19	32	8.5
DO63315014	E14	A	16.5	19	32	10
DO63315016	E16	A	18.4	19	32	11

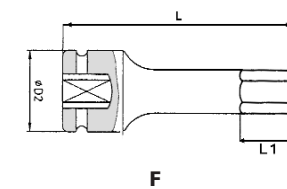

3/8" Torx® impact sockets - internal ③

Type	A/F mm	Drawing	D1 mm	D2 mm	L1 mm	L mm
<i>Metrical</i>						
DO64711009	T9	F	-	19	2.8	50
DO64711010	T10	F	-	19	2.8	50
DO64711015	T15	F	-	19	2.8	50
DO64711020	T20	F	-	19	3.0	50
DO64711025	T25	F	-	19	3.0	50
DO64711027	T27	F	-	19	3.8	50
DO64711030	T30	F	-	19	3.8	50
DO64711040	T40	F	-	19	4.3	50
DO64711045	T45	F	-	19	5.0	50
DO64711047	T47	F	-	19	5.0	50
DO64711050	T50	F	-	19	5.5	50

3/8" Torx® Tamper Resistant impact sockets - internal ④

Type	A/F mm	Drawing	D1 mm	D2 mm	L1 mm	L mm
<i>Metrical</i>						
DO64716020	T20	F	-	19	3.0	50
DO64716025	T25	F	-	19	3.0	50
DO64716027	T27	F	-	19	3.8	50
DO64716030	T30	F	-	19	3.8	50
DO64716040	T40	F	-	19	4.3	50
DO64716045	T45	F	-	19	5.0	50
DO64716047	T47	F	-	19	5.0	50
DO64716050	T50	F	-	19	5.5	50

3/8" Impact sockets, thin wall - long ⑤

Type	A/F mm	Drawing	D1 mm	D2 mm	L mm	L2 mm
<i>Metrical</i>						
DO61112007	7	A	11.5	19	65	12
DO61112008	8	A	12.5	19	65	12
DO61112009	9	A	14	19	65	12
DO61112010	10	A	15	19	65	25
DO61112011	11	A	17	19	65	25
DO61112012	12	A	17.5	19	65	25
DO61112013	13	B	19	19	65	25
DO61112014	14	B	20	20	65	25
DO61112015	15	A	21	22	65	25
DO61112016	16	C	22.5	22	65	25
DO61112017	17	C	24	22	65	25
DO61112018	18	C	25	22	65	25
DO61112019	19	C	26	22	65	25
DO61112020	20	C	27	22	65	25
DO61112021	21	C	28	22	65	25
DO61112022	22	C	30	23	65	25

Impact sockets

3/8"

3/8"



Universal joint sockets



Impact sockets, thin wall

3/8" Universal joint sockets - normal 1

Type	A/F mm	Drawing	D1 mm	D2 mm	L mm	L2 mm
<i>Metrical</i>						
DO1038-2-009	9	E	15	24	53	9
DO1038-2-010	10	E	15	24	53	9
DO1038-2-011	11	E	17	24	53	9
DO1038-2-012	12	E	19	24	53	12
DO1038-2-013	13	E	19	24	53	13
DO1038-2-014	14	E	21	24	53	13
DO1038-2-015	15	E	22	24	53	13
DO1038-2-016	16	E	23	24	53	13
DO1038-2-017	17	E	25	24	53	13
DO1038-2-018	18	E	25	24	53	13
DO1038-2-019	19	E	27	24	53	13
DO1038-2-020	20	E	30	24	53	13
DO1038-2-021	21	E	30	24	53	13
DO1038-2-022	22	E	32	24	53	13

3/8" Universal joint sockets - long 2

Type	A/F mm	Drawing	D1 mm	D2 mm	L mm	L2 mm
<i>Metrical</i>						
DO1038-4-009	9	E	15	24	78	20
DO1038-4-010	10	E	15	24	78	20
DO1038-4-011	11	E	17	24	80	20
DO1038-4-012	12	E	19	24	80	20
DO1038-4-013	13	E	19	24	80	20
DO1038-4-014	14	E	21	24	80	20
DO1038-4-015	15	E	22	24	80	20
DO1038-4-016	16	E	23	24	80	20
DO1038-4-017	17	E	25	24	80	20
DO1038-4-018	18	E	25	24	80	20
DO1038-4-019	19	E	27	24	80	25
DO1038-4-020	20	E	30	24	80	25
DO1038-4-021	21	E	30	24	80	25
DO1038-4-022	22	E	32	24	80	25

Universal joint sockets are secured by means of a ring.

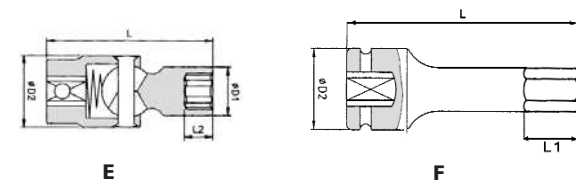

3/8" Impact sockets hex head 3

Type	A/F mm	Drawing	D2 mm	L1 mm	L mm
<i>Metrical</i>					
DO696203A	3	F	19	16	50
DO696204A	4	F	19	16	50
DO696205A	5	F	19	16	50
DO696206A	6	F	19	16	50
DO696207A	7	F	19	16	50
DO696208A	8	F	19	16	50
DO696209A	9	F	19	16	50
DO696210A	10	F	19	16	50
DO696211A	11	F	19	16	50
DO696212A	12	F	19	16	50
DO696213A	13	F	19	16	50
DO696214A	14	F	19	16	50
DO696215A	15	F	19	16	50
DO696216A	16	F	19	16	50

3/8" Impact sockets triple square bit 4

Type	A/F mm	Drawing	D2 mm	L mm	L1 mm
<i>Metrical</i>					
DO65216005	5	F	19	50	7
DO65216006	6	F	19	50	7
DO65216008	8	F	19	50	9
DO65216010	10	F	19	50	9
DO65216012	12	F	19	50	11
DO65216014	14	F	19	50	11
DO65216016	16	F	19	50	13

3/8" Impact sockets triple square bit - long 5

Type	A/F mm	Drawing	D2 mm	L mm	L1 mm
<i>Metrical</i>					
DO65217005	5	F	19	100	7
DO65217006	6	F	19	100	7
DO65217008	8	F	19	100	9
DO65217010	10	F	19	100	9
DO65217012	12	F	19	100	11
DO65217014	14	F	19	100	11
DO65217016	16	F	19	100	13



3/8" Universal joint sockets hex head 1

Type	A/F mm	Drawing	D2 mm	L mm	L2 mm
<i>Metrical</i>					
DO65110005	5	E	24	60	11
DO65110006	6	E	24	60	11
DO65110007	7	E	24	60	15
DO65110008	8	E	24	60	15
DO65110009	9	E	24	60	15
DO65110010	10	E	24	60	15
DO65110011	11	E	24	60	15
DO65110012	12	E	24	60	15
DO65110013	13	E	24	60	15
DO65110014	14	E	24	60	15
DO65110015	15	E	24	60	15
DO65110016	16	E	24	60	15

3/8" Universal joint sockets for internal Torx® 2

Type	A/F mm	Drawing	D2 mm	L mm
<i>Metrical</i>				
DO64910020	T20	E	24	60
DO64910025	T25	E	24	60
DO64910027	T27	E	24	60
DO64910030	T30	E	24	60
DO64910040	T40	E	24	60
DO64910045	T45	E	24	60
DO64910047	T47	E	24	60
DO64910050	T50	E	24	60
DO64910055	T55	E	24	60

3/8" Universal joint sockets for external Torx® 3

Type	A/F mm	Drawing	D2 mm	L mm	L2 mm
<i>Metrical</i>					
DO68710005	E5	E	24	50	4.5
DO68710006	E6	E	24	50	5
DO68710007	E7	E	24	50	6
DO68710008	E8	E	24	50	6
DO68710010	E10	E	24	50	7.5
DO68710012	E12	E	24	50	8.5
DO68710014	E14	E	24	50	10
DO68710016	E16	E	24	50	11

3/8" Pin and ring

DO1038-0-000 3/8"

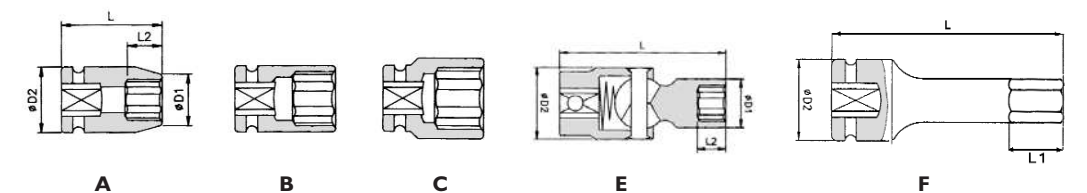

Impact sockets

1/2"

1/2" Impact sockets - normal ①

Type	A/F mm/inch	Drawing	D1 mm	D2 mm	L mm	L2 mm
<i>Metrical</i>						
DO2012-0-008	8	A	14.5	24	38	9
DO2012-0-009	9	A	16	24	38	12
DO2012-0-010	10	A	17	24	38	12
DO2012-0-011	11	A	19	24	38	12
DO2012-0-012	12	A	20	24	38	12
DO2012-0-013	13	A	21	24	38	12
DO2012-0-014	14	A	22	24	38	12
DO2012-0-015	15	A	24	24	38	12
DO2012-0-016	16	A	25	26	38	12
DO2012-0-017	17	A	26	26	38	13
DO2012-0-018	18	A	27.5	28	38	13
DO2012-0-019	19	A	29	30	38	13
DO2012-0-020	20	B	30	30	38	13
DO2012-0-021	21	B	32	32	38	13
DO2012-0-022	22	C	32	32	38	13
DO2012-0-023	23	C	32.5	34	38	13
DO2012-0-024	24	C	35	36	45	20
DO2012-0-025	25	C	36	36	45	20
DO2012-0-026	26	C	37.5	38	45	22
DO2012-0-027	27	C	39	38	50	22
DO2012-0-028	28	C	40	38	50	22
DO2012-0-029	29	C	41	38	50	22
DO2012-0-030	30	C	42.5	38	50	22
DO2012-0-032	32	C	44	38	50	28
DO2012-0-034	34	C	45	38	50	28
DO2012-0-036	36	C	48	38	50	28

Type	A/F mm/inch	Drawing	D1 mm	D2 mm	L mm	L2 mm
<i>Inch</i>						
DO2012-0-3/8	3/8"	A	16	22	38	12
DO2012-0-7/16	7/16"	A	18	22	38	12
DO2012-0-1/2	1/2"	A	20	22	38	12
DO2012-0-9/16	9/16"	A	22	24	38	12
DO2012-0-5/8	5/8"	B	25	25	38	12
DO2012-0-11/16	11/16"	B	26	26	38	13
DO2012-0-3/4	3/4"	B	28	28	38	13
DO2012-0-13/16	13/16"	B	30	30	38	13
DO2012-0-7/8	7/8"	B	32	32	38	13
DO2012-0-15/16	15/16"	B	34	34	38	13
DO2012-0-1	1"	B	36	36	38	14
DO2012-0-1 1/16	1 1/16"	B	38	38	40	16
DO2012-0-1 1/8	1 1/8"	B	40	38	40	16
DO2012-0-1 3/16	1 3/16"	C	42	38	40	16
DO2012-0-1 1/4	1 1/4"	C	44	38	40	18

1/2" Magnetical impact sockets - normal ②

Type	A/F mm	Drawing	D1 mm	D2 mm	L mm	L2 mm
<i>Metrical</i>						
DO6052P008	8	A	15	25	38	3
DO6052P009	9	A	16	25	38	4
DO6052P010	10	A	17.5	25	38	4
DO6052P011	11	A	18.5	25	38	5
DO6052P012	12	A	20	25	38	5
DO6052P013	13	A	21	25	38	5
DO6052P014	14	A	22.5	25	38	6
DO6052P015	15	A	23.7	30	38	6
DO6052P016	16	A	25	30	38	6
DO6052P017	17	A	26.5	30	38	6
DO6052P018	18	A	27.5	30	38	7
DO6052P019	19	A	29	30	38	7
DO6052P020	20	B	30	30	38	7
DO6052P021	21	C	31	30	38	8
DO6052P022	22	C	32.5	30	38	8
DO6052P024	24	C	35	30	45	10

1/2" Impact sockets - long ③

Type	A/F mm	Drawing	D1 mm	D2 mm	L mm	L2 mm
<i>Metrical</i>						
DO2012-1-008	8	A	14.5	25	78	13
DO2012-1-009	9	A	16	25	78	14
DO2012-1-010	10	A	17	25	78	14
DO2012-1-011	11	A	18	25	78	14
DO2012-1-012	12	A	19.5	25	78	14
DO2012-1-013	13	A	21	25	78	14
DO2012-1-014	14	A	22	25	78	17
DO2012-1-015	15	A	23.5	30	78	17
DO2012-1-016	16	A	23.5	30	78	17
DO2012-1-017	17	A	26	30	78	17
DO2012-1-018	18	A	26	30	78	17
DO2012-1-019	19	A	28	30	78	19
DO2012-1-020	20	B	30.5	30	78	19
DO2012-1-021	21	B	31	30	78	24
DO2012-1-022	22	C	32.5	30	78	24
DO2012-1-023	23	C	32.5	30	78	24
DO2012-1-024	24	C	35	30	78	24
DO2012-1-025	25	C	36	30	78	24
DO2012-1-026	26	C	37.5	30	78	24
DO2012-1-027	27	C	38	30	78	54
DO2012-1-028	28	C	40	30	78	54
DO2012-1-029	29	C	40	30	78	54
DO2012-1-030	30	C	42	30	78	54
DO2012-1-031	31	C	43	30	78	54
DO2012-1-032	32	C	45	30	78	54



1/2"

1/2" Impact sockets - long continued ①

Type	A/F mm/inch	Drawing	D1 mm	D2 mm	L mm	L2 mm
<i>Metrical</i>						
DO2012-1-033	33	C	45	30	78	54
DO2012-1-034	34	C	45	30	78	54
DO2012-1-035	35	C	47	30	78	54
DO2012-1-036	36	C	49	30	78	54

Type	A/F mm/inch	Drawing	D1 mm	D2 mm	L mm	L2 mm
<i>Inch</i>						
DO2012-1-7/16	7/16"	A	18	22	78	14
DO2012-1-1/2	1/2"	A	20	22	78	14
DO2012-1-9/16	9/16"	A	22	24	78	17
DO2012-1-5/8	5/8"	B	26	26	78	17
DO2012-1-11/16	11/16"	B	26	26	78	17
DO2012-1-3/4	3/4"	B	28	28	78	19
DO2012-1-13/16	13/16"	B	30	30	78	24

1/2" Magnetical impact sockets - long ②

Type	A/F mm	Drawing	D1 mm	D2 mm	L mm	L2 mm
<i>Metrical</i>						
DO6052R008	8	A	15	25	78	3
DO6052R009	9	A	16	25	78	4
DO6052R010	10	A	17.5	25	78	4
DO6052R011	11	A	18.5	25	78	5
DO6052R012	12	A	20	25	78	5
DO6052R013	13	A	21	25	78	5
DO6052R014	14	A	22.5	25	78	6
DO6052R015	15	A	23.7	30	78	6
DO6052R016	16	A	25	30	78	6
DO6052R017	17	A	26.5	30	78	6
DO6052R018	18	A	27.5	30	78	7
DO6052R019	19	A	29	30	78	7
DO6052R020	20	B	30	30	78	7
DO6052R021	21	C	31	30	78	8
DO6052R022	22	C	32.5	30	78	8
DO6052R024	24	C	35	30	78	10

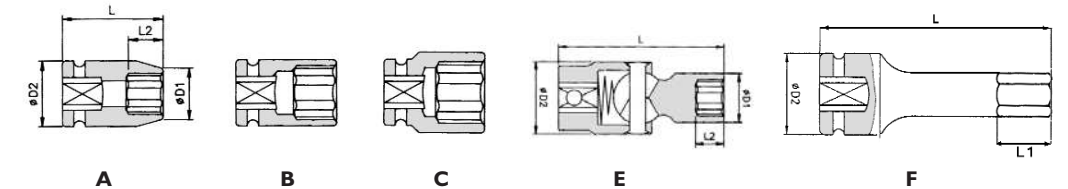

Hex head socket

1/2" Impact sockets - 12-point - normal ③

Type	A/F mm	Drawing	D1 mm	D2 mm	L mm	L2 mm
<i>Metrical</i>						
DO63825008	8	A	15	24	38	9
DO63825009	9	A	15	24	38	12
DO63825010	10	A	17	24	38	12
DO63825011	11	A	18	24	38	12
DO63825012	12	A	19	24	38	12
DO63825013	13	A	20	24	38	12
DO63825014	14	A	22	24	38	12
DO63825015	15	B	24	24	38	12
DO63825016	16	B	24	26	38	12
DO63825017	17	B	26	26	38	13
DO63825018	18	B	26	28	38	13
DO63825019	19	B	28	30	38	13
DO63825020	20	B	30	30	38	13
DO63825021	21	B	30	32	38	13
DO63825022	22	B	32	32	38	13
DO63825023	23	B	32	34	38	13
DO63825024	24	B	34	36	45	19
DO63825025	25	B	36	36	45	19
DO63825026	26	B	36	38	50	20
DO63825027	27	B	38	38	50	20
DO63825028	28	C	40	38	50	20
DO63825029	29	C	40	38	50	20
DO63825030	30	C	42	38	50	20
DO63825032	32	C	44	38	50	20
DO63825033	33	C	45	38	50	25
DO63825036	36	C	48	38	50	25

Impact sockets

1/2"

1/2" Impact sockets - 12-point - long ①

Type	A/F mm	Drawing	D1 mm	D2 mm	L mm	L2 mm
<i>Metrical</i>						
DO65827006	6	A	13	25	83	6
DO65827007	7	A	14	25	83	7
DO65827008	8	A	15	25	83	13
DO65827009	9	A	16	25	83	14
DO65827010	10	A	17.5	25	83	14
DO65827011	11	A	18.5	25	83	14
DO65827012	12	A	20	25	83	14
DO65827013	13	A	21	25	83	14
DO65827014	14	A	22.5	25	83	24
DO65827015	15	A	23.5	30	83	24
DO65827016	16	A	25	30	83	24
DO65827017	17	A	26	30	83	24
DO65827018	18	A	27.5	30	83	24
DO65827019	19	A	28.5	30	83	24
DO65827020	20	B	30	30	83	24
DO65827021	21	C	31	30	83	24
DO65827022	22	C	32	30	90	24
DO65827023	23	C	34	30	90	24
DO65827024	24	C	35	30	90	24
DO65827025	25	C	36	30	90	24
DO65827026	26	C	38	30	90	24
DO65827027	27	C	38.5	30	90	24
DO65827028	28	C	40	30	90	24
DO65827029	29	C	41	30	90	24
DO65827030	30	C	42	30	90	24
DO65827031	31	C	43	30	90	24
DO65827032	32	C	44	30	90	24
DO65827033	33	C	46	30	90	35
DO65827034	34	C	48	30	90	36
DO65827035	35	C	50	30	90	37
DO65827036	36	C	52	30	90	38
DO65827038	38	C	54	38	90	40
DO65827041	41	C	58.5	44	90	43
DO65827042	42	C	60	44	90	44
DO65827046	46	C	65	44	90	48

1/2" Impact sockets - L = 150 ②

Type	A/F mm	Drawing	D1 mm	D2 mm	L mm	L2 mm
<i>Metrical</i>						
DO60725008	8	G	15	25	150	10
DO60725010	10	G	17	25	150	12
DO60725012	12	G	19.5	25	150	12
DO60725013	13	G	20.5	25	150	12
DO60725014	14	G	22	25	150	12
DO60725015	15	G	23	25	150	12
DO60725017	17	G	25.5	25	150	13
DO60725019	19	G	28	25	150	13
DO60725020	20	G	30	25	150	13
DO60725021	21	G	30	25	150	3

1/2" Impact sockets - L = 200 ③

Type	A/F mm	Drawing	D1 mm	D2 mm	L mm	L2 mm
<i>Metrical</i>						
DO60726008	8	G	15	25	200	10
DO60726010	10	G	17	25	200	12
DO60726012	12	G	19.5	25	200	12
DO60726013	13	G	20.5	25	200	12
DO60726014	14	G	22	25	200	12
DO60726015	15	G	23	25	200	12
DO60726017	17	G	25.5	25	200	13
DO60726019	19	G	28	25	200	13
DO60726020	20	G	30	25	200	13
DO60726021	21	G	30	25	200	13

1/2" Impact sockets - L = 250 ④

Type	A/F mm/inch	Drawing	D1 mm	D2 mm	L mm	L2 mm
<i>Metrical</i>						
DO60727008	8	G	15	25	250	10
DO60727010	10	G	17	25	250	12
DO60727012	12	G	19.5	25	250	12
DO60727013	13	G	20.5	25	250	12
DO60727014	14	G	22	25	250	12
DO60727015	15	G	23	25	250	12
DO60727017	17	G	25.5	25	250	13
DO60727019	19	G	28	25	250	13
DO60727020	20	G	30	25	250	13
DO60727021	21	G	30	25	250	13



1/2"

1/2" Surface Drive impact sockets - normal ①

Type	A/F mm	Drawing	D1 mm	D2 mm	L mm	L2 mm
<i>Metrical</i>						
DO63425010	10	A	17.5	25	38	12
DO63425011	11	A	18.7	25	38	12
DO63425012	12	A	20	25	38	12
DO63425013	13	A	21	25	38	12
DO63425014	14	A	22.5	25	38	12
DO63425015	15	A	23.7	30	38	12
DO63425016	16	A	25	30	38	12
DO63425017	17	A	26	30	38	13
DO63425018	18	A	27.5	30	38	13
DO63425019	19	A	28.7	30	38	13
DO63425020	20	B	30	30	38	13
DO63425021	21	B	30	30	38	13
DO63425022	22	C	32	30	38	13
DO63425023	23	C	32	30	38	13
DO63425024	24	C	35	30	45	20
DO63425026	26	C	38	30	50	22
DO63425027	27	C	38.7	30	50	22
DO63425029	29	C	40	30	50	22
DO63425030	30	C	42	30	50	22
DO63425032	32	C	44	30	50	28

1/2" Surface Drive impact sockets - long ③

Type	A/F mm	Drawing	D1 mm	D2 mm	L mm	L2 mm
<i>Metrical</i>						
DO63427010	10	A	17.5	25	83	14
DO63427011	11	A	18.7	25	83	14
DO63427012	12	A	20	25	83	14
DO63427013	13	A	21	25	83	14
DO63427014	14	A	22.5	25	83	17
DO63427015	15	A	23.7	30	83	17
DO63427016	16	A	25	30	83	17
DO63427017	17	A	26	30	83	17
DO63427018	18	A	27.5	30	83	17
DO63427019	19	A	28.7	30	83	19
DO63427020	20	B	30	30	83	19
DO63427021	21	B	30	30	83	24
DO63427022	22	C	32	30	90	60
DO63427023	23	C	32	30	90	60
DO63427024	24	C	35	30	90	60
DO63427026	26	C	38	30	90	60
DO63427027	27	C	38.7	30	90	60
DO63427029	29	C	40	30	90	60
DO63427030	30	C	42	30	90	60
DO63427032	32	C	44	30	90	60

1/2" Impact sockets for hex head ②

Type	A/F mm	Drawing	D2 mm	L mm	L2 mm
<i>Metrical</i>					
DO696304A	4	D	25	75	20
DO696305A	5	D	25	75	20
DO696306A	6	D	25	75	20
DO696307A	7	D	25	75	20
DO696308A	8	D	25	75	25
DO696309A	9	D	25	75	25
DO696310A	10	D	25	75	25
DO696311A	11	D	25	75	25
DO696312A	12	D	25	75	25
DO696313A	13	D	25	75	25
DO696314A	14	D	25	75	25
DO696315A	15	D	25	75	25
DO696316A	16	D	25	75	25
DO696317A	17	D	25	75	25
DO696319A	19	D	25	75	25

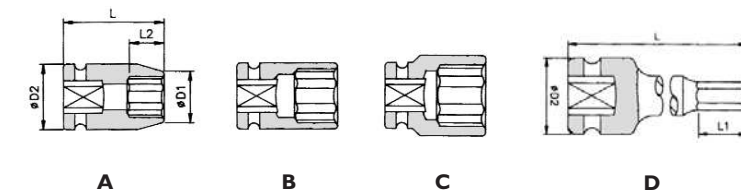
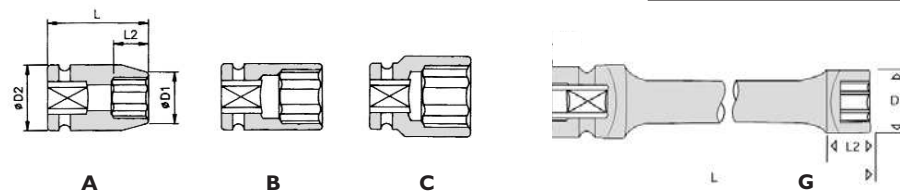

Impact sockets

1/2"

1/2" Torx® impact sockets - external 1

Type	A/F mm	Drawing	D1 mm	D2 mm	L mm	L2 mm
<i>Metrical</i>						
DO63320010	E10	A	15	25	38	7.5
DO63320011	E11	A	15.5	25	38	8
DO63320012	E12	A	16	25	38	8.5
DO63320014	E14	A	18.5	25	38	10
DO63320016	E16	A	20	25	38	11
DO63320018	E18	A	22	25	38	12
DO63320020	E20	A	25	30	38	13.5
DO63320022	E22	A	26.5	30	45	18
DO63320024	E24	A	28.5	30	45	18

1/2" Torx® impact sockets thin wall - external 2

Type	A/F mm	Drawing	D1 mm	D2 mm	L mm	L2 mm
<i>Metrical</i>						
DO63325010	E10	A	13	25	38	7.5
DO63325011	E11	A	14	25	38	8
DO63325012	E12	A	15	25	38	8.5
DO63325014	E14	A	17	25	38	10
DO63325016	E16	A	18.5	25	38	11
DO63325018	E18	A	20.5	25	38	12
DO63325020	E20	A	22.5	30	38	13.5
DO63325022	E22	A	24.5	30	45	18
DO63325024	E24	A	26.5	30	45	18

1/2" Torx® Impact sockets - internal 3

Type	A/F mm	Drawing	D2 mm	L1 mm	L mm
<i>Metrical</i>					
DO64721020	T20	F	25	2.8	55
DO64721025	T25	F	25	3.0	55
DO64721027	T27	F	25	3.0	55
DO64721030	T30	F	25	3.8	55
DO64721040	T40	F	25	3.8	55
DO64721045	T45	F	25	4.3	55
DO64721047	T47	F	25	5.0	55
DO64721050	T50	F	25	5.0	55
DO64721055	T55	F	25	5.5	55
DO64721060	T60	F	25	8.0	55
DO64721070	T70	F	25	9.4	55

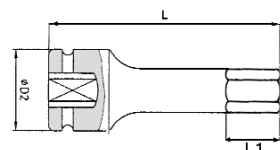

F

1/2" Torx® Tamper Resistant impact sockets - internal 4

Type	A/F mm	Drawing	D2 mm	L1 mm	L mm
<i>Metrical</i>					
DO64726020	T20	F	25	2.8	55
DO64726025	T25	F	25	3.0	55
DO64726027	T27	F	25	3.0	55
DO64726030	T30	F	25	3.8	55
DO64726040	T40	F	25	3.8	55
DO64726045	T45	F	25	4.3	55
DO64726047	T47	F	25	5.0	55
DO64726050	T50	F	25	5.0	55
DO64726055	T55	F	25	5.5	55
DO64726060	T60	F	25	8.0	55
DO64726070	T70	F	25	9.4	55

1/2" Torx® impact sockets - internal - long 5

Type	A/F mm	Drawing	D2 mm	L1 mm	L mm
<i>Metrical</i>					
DO64722020	T20	F	25	2.8	75
DO64722025	T25	F	25	3.0	75
DO64722027	T27	F	25	3.0	75
DO64722030	T30	F	25	3.8	75
DO64722040	T40	F	25	3.8	75
DO64722045	T45	F	25	4.3	75
DO64722047	T47	F	25	5.0	75
DO64722050	T50	F	25	5.0	75
DO64722055	T55	F	25	5.5	75
DO64722060	T60	F	25	8.0	75
DO64722070	T70	F	25	9.4	75

1/2" Torx® Tamper Resistant impact sockets - internal - long 6

Type	A/F mm	Drawing	D2 mm	L1 mm	L mm
<i>Metrical</i>					
DO64727020	T20	F	25	2.8	75
DO64727025	T25	F	25	3.0	75
DO64727027	T27	F	25	3.0	75
DO64727030	T30	F	25	3.8	75
DO64727040	T40	F	25	3.8	75
DO64727045	T45	F	25	4.3	75
DO64727047	T47	F	25	5.0	75
DO64727050	T50	F	25	5.0	75
DO64727055	T55	F	25	5.5	75
DO64727060	T60	F	25	8.0	75
DO64727070	T70	F	25	9.4	75

Torx® is a trademark of Textron.



1/2"

1/2" Impact sockets thin wall - long 1

Type	A/F mm	Drawing	D1 mm	D2 mm	L mm	L2 mm
<i>Metrical</i>						
DO61122008	8	A	14	22	78	13
DO61122009	9	A	14.5	22	78	14
DO61122010	10	A	15.5	22	78	14
DO61122011	11	A	16.7	22	78	14
DO61122012	12	A	18	22	78	14
DO61122013	13	A	19.2	24	78	14
DO61122014	14	A	21	24	78	17
DO61122015	15	A	21.7	24	78	17
DO61122016	16	A	23	24	78	17
DO61122017	17	B	24	24	78	17
DO61122018	18	B	25	25	78	17
DO61122019	19	B	26	26	78	19
DO61122020	20	B	27.5	27.5	78	19
DO61122021	21	B	28	28	78	24
DO61122022	22	B	29.5	29.5	78	24
DO61122023	23	B	30.5	30.5	78	24
DO61122024	24	B	32	32	78	24
DO61122025	25	B	33	33	78	24
DO61122026	26	B	35	35	78	24
DO61122027	27	B	36	36	78	24
DO61122028	28	B	37.5	37.5	78	24
DO61122029	29	C	38.5	38	78	54
DO61122030	30	C	40	38	78	54
DO61122031	31	C	41	38	78	54
DO61122032	32	C	42	38	78	54

1/2" Impact sockets thin wall, with plastic stop and sleeve - long 2

Type	A/F mm	Drawing	D1 mm	D2 mm	D3 mm	L mm	L2 mm
<i>Metrical</i>							
DO61126015 (Weiß)	15	G	22	30	25	85	13
DO61126017 (Blau)	17	G	24	30	27	85	14
DO61126019 (Gelb)	19	G	26	30	29	85	15
DO61126021 (Rot)	21	G	28	30	31	85	17
DO61126022 (Grün)	22	G	29.5	30	32.5	85	18

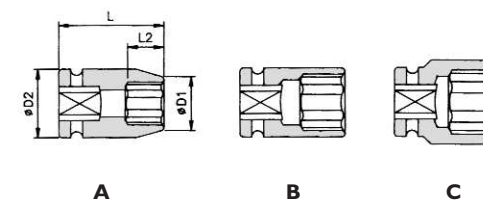

1/2" Universal joint sockets - normal 3

Type	A/F mm	Drawing	D1 mm	D2 mm	L mm	L2 mm
<i>Metrical</i>						
DO2012-2-010	10	E	15	28	65	14
DO2012-2-011	11	E	17	28	65	14
DO2012-2-012	12	E	19	28	65	14
DO2012-2-013	13	E	20	28	65	14
DO2012-2-014	14	E	22	28	65	14
DO2012-2-015	15	E	23	28	65	14
DO2012-2-016	16	E	23	28	65	14
DO2012-2-017	17	E	26	32	65	14
DO2012-2-018	18	E	26	32	65	14
DO2012-2-019	19	E	28	32	65	14
DO2012-2-020	20	E	30	32	65	14
DO2012-2-021	21	E	30	32	65	14
DO2012-2-022	22	E	32	32	65	14
DO2012-2-023	23	E	32	32	65	14
DO2012-2-024	24	E	34	32	65	14

1/2" Universal joint sockets - long 4

Type	A/F mm	Drawing	D1 mm	D2 mm	L mm	L2 mm
<i>Metrical</i>						
DO2012-4-010	10	E	15	28	90	14
DO2012-4-011	11	E	17	28	90	20
DO2012-4-012	12	E	19	28	90	20
DO2012-4-013	13	E	20	28	90	20
DO2012-4-014	14	E	22	28	90	20
DO2012-4-015	15	E	23	28	90	20
DO2012-4-016	16	E	23	28	90	20
DO2012-4-017	17	E	26	32	90	20
DO2012-4-018	18	E	26	32	90	20
DO2012-4-019	19	E	28	32	90	25
DO2012-4-020	20	E	30	32	90	25
DO2012-4-021	21	E	30	32	90	25
DO2012-4-022	22	E	32	32	90	25
DO2012-4-023	23	E	32	32	90	25
DO2012-4-024	24	E	34	32	90	25

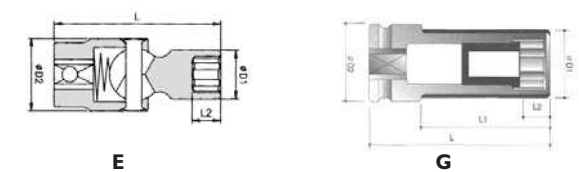

Hex head socket

Impact sockets

1/2"

1/2" Impact sockets triple square bit - normal ①

Type	A/F mm	Drawing mm	D2 mm	L mm	L1 mm
<i>Metrical</i>					
DO65226005	5	D	25	55	7
DO65226006	6	D	25	55	7
DO65226008	8	D	25	55	9
DO65226010	10	D	25	55	9
DO65226012	12	D	25	55	11
DO65226014	14	D	25	55	11
DO65226016	16	D	25	55	13

1/2" Impact sockets triple square bit - long ②

Type	A/F mm	Drawing mm	D2 mm	L mm	L1 mm
<i>Metrical</i>					
DO65227005	5	D	25	100	7
DO65227006	6	D	25	100	7
DO65227008	8	D	25	100	9
DO65227010	10	D	25	100	9
DO65227012	12	D	25	100	11
DO65227014	14	D	25	100	11
DO65227016	16	D	25	100	13

1/2" Universal joint sockets for hex head ③

Type	A/F mm	Drawing mm	D2 mm	L mm	L1 mm
<i>Metrical</i>					
DO65121006	6	E	28	75	13
DO65121007	7	E	28	75	13
DO65121008	8	E	28	75	20
DO65121009	9	E	28	75	20
DO65121010	10	E	28	75	20
DO65121011	11	E	28	75	20
DO65121012	12	E	28	75	20
DO65121013	13	E	28	75	20
DO65121014	14	E	28	75	20
DO65121015	15	E	28	75	20
DO65121016	16	E	28	75	20
DO65121017	17	E	28	75	20
DO65121018	18	E	28	75	20
DO65121019	19	E	28	75	20

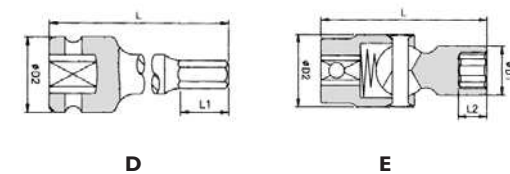

1/2" Universal joint sockets for internal Torx® ④

Type	A/F mm	Drawing mm	D2 mm	L mm
<i>Metrical</i>				
DO64921025	T25	E	28	70
DO64921027	T27	E	28	70
DO64921030	T30	E	28	70
DO64921040	T40	E	28	70
DO64921045	T45	E	28	70
DO64921047	T47	E	28	70
DO64921050	T50	E	28	70
DO64921055	T55	E	28	70
DO64921060	T60	E	28	70

1/2" Universal joint sockets for external Torx® ⑤

Type	A/F mm	Drawing mm	D1 mm	D2 mm	L mm	L2 mm
<i>Metrical</i>						
DO68720010	E10	E	13	28	65	7.5
DO68720011	E11	E	14	28	65	8.0
DO68720012	E12	E	15	28	65	8.5
DO68720014	E14	E	17	28	65	10
DO68720016	E16	E	18.5	28	65	11
DO68720018	E18	E	20.5	28	65	12
DO68720020	E20	E	22.5	32	70	13.5
DO68720022	E22	E	24.5	32	70	15
DO68720024	E24	E	26.5	32	70	17

Torx® is a trademark of Textron.

1/2" Pin and ring

DO1012-0-000	1/2"
--------------	------



3/4"

3/4" Impact sockets - normal ①

Type	A/F mm	Drawing	D1 mm	D2 mm	L mm	L2 mm
<i>Metrical</i>						
DO3034-0-013	13	A	25	44	50	12
DO3034-0-014	14	A	25	44	50	12
DO3034-0-015	15	A	29	44	50	12
DO3034-0-016	16	A	30	44	50	12
DO3034-0-017	17	A	31	44	50	12
DO3034-0-018	18	A	32	44	50	12
DO3034-0-019	19	A	33	44	50	14
DO3034-0-020	20	A	34	44	50	16
DO3034-0-021	21	A	36	44	50	16
DO3034-0-022	22	A	37	44	50	16
DO3034-0-023	23	A	38	44	50	16
DO3034-0-024	24	A	40	44	50	16
DO3034-0-025	25	A	40	44	50	16
DO3034-0-026	26	A	41	44	50	16
DO3034-0-027	27	A	43	44	54	16
DO3034-0-028	28	B	44	44	54	23
DO3034-0-029	29	C	45	44	54	23
DO3034-0-030	30	C	47	44	54	23
DO3034-0-031	31	C	49	44	56	23
DO3034-0-032	32	C	49	44	56	23
DO3034-0-033	33	C	51	44	56	23
DO3034-0-034	34	C	52	44	56	23
DO3034-0-035	35	C	53	44	56	23
DO3034-0-036	36	C	54	44	56	23
DO3034-0-037	37	C	55	44	56	24
DO3034-0-038	38	C	57	44	58	24
DO3034-0-041	41	C	61	44	58	24
DO3034-0-042	42	C	62	44	58	24
DO3034-0-043	43	C	63	44	63	27
DO3034-0-046	46	C	67	44	63	27
DO3034-0-047	47	C	68	44	68	32
DO3034-0-048	48	C	69	44	68	32
DO3034-0-050	50	C	71	54	72	35
DO3034-0-055	55	C	77	54	74	35
DO3034-0-060	60	C	84	54	75	35
DO3034-0-063	63	C	86	54	75	35
DO3034-0-065	65	C	88	54	78	38
DO3034-0-067	67	C	90	54	80	40

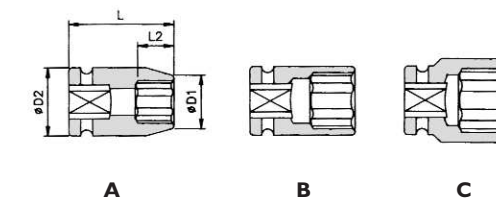

3/4" Impact sockets - normal ②

Type	A/F Zoll	Drawing	D1 mm	D2 mm	L mm	L2 mm
<i>Inch</i>						
DO3034-0-11/16	11/16"	A	29	38	50	12
DO3034-0-3/4	3/4"	A	30	38	50	14
DO3034-0-13/16	13/16"	A	32	38	52	16
DO3034-0-7/8	7/8"	A	34	38	52	16
DO3034-0-15/16	15/16"	A	36	38	52	16
DO3034-0-1 1/8	1 1/8"	B	42	42	52	20
DO3034-0-1 3/16	1 3/16"	B	44	44	52	20
DO3034-0-1 1/4	1 1/4"	B	44	44	52	20
DO3034-0-1	1"	C	40	38	52	16
DO3034-0-1 1/16	1 1/16"	C	40	38	52	16
DO3034-0-1 5/16	1 5/16"	C	47	44	56	23
DO3034-0-1 3/8	1 3/8"	C	50	44	56	23
DO3034-0-1 7/16	1 7/16"	C	51	44	56	23
DO3034-0-1 1/2	1 1/2"	C	53	44	56	23
DO3034-0-1 13/16	1 13/16"	C	67	44	56	32

3/4" Pin and ring

DO1034-0-000	3/4"
--------------	------



Impact sockets

3/4"

3/4" Impact sockets - long ①

Type	A/F mm	Drawing	D1 mm	D2 mm	L mm	L2 mm
<i>Metrical</i>						
D03034-1-013	13	A	25	44	95	20
D03034-1-014	14	A	25	44	95	20
D03034-1-015	15	A	26	44	95	20
D03034-1-017	17	A	31	44	95	20
D03034-1-018	18	A	32	44	95	20
D03034-1-019	19	A	33	44	95	23
D03034-1-020	20	A	34	44	95	23
D03034-1-021	21	A	36	44	95	23
D03034-1-022	22	A	37	44	95	23
D03034-1-023	23	A	38	44	95	23
D03034-1-024	24	A	39.5	44	95	51
D03034-1-025	25	A	40	44	95	51
D03034-1-026	26	A	41	44	95	51
D03034-1-027	27	A	43	44	95	62
D03034-1-028	28	B	44	44	95	62
D03034-1-029	29	C	45	44	95	62
D03034-1-030	30	C	47	44	95	62
D03034-1-031	31	C	48	44	95	62
D03034-1-032	32	C	49	44	95	62
D03034-1-033	33	C	51	44	95	62
D03034-1-034	34	C	52	44	95	62
D03034-1-035	35	C	54	44	95	62
D03034-1-036	36	C	55	44	95	62
D03034-1-037	37	C	55	44	95	62
D03034-1-038	38	C	57	44	95	60
D03034-1-039	39	C	58	44	95	60
D03034-1-040	40	C	58	44	95	60
D03034-1-041	41	C	60	44	95	60
D03034-1-042	42	C	62	44	95	60
D03034-1-043	43	C	63	44	95	60
D03034-1-044	44	C	65	44	95	60
D03034-1-046	46	C	67	44	95	58
D03034-1-047	47	C	68	44	95	58
D03034-1-048	48	C	69	44	95	58
D03034-1-049	49	C	70	44	95	58
D03034-1-050	50	C	71	54	95	58
D03034-1-052	52	C	74	54	95	58
D03034-1-055	55	C	77	54	100	58
D03034-1-060	60	C	84	54	105	58
D03034-1-065	65	C	88	54	105	58

3/4" Impact sockets - long ②

Type	A/F Zoll	Drawing	D1 mm	D2 mm	L mm	L2 mm
<i>Inch</i>						
D03034-1-13/16	13/16"	A	32	38	85	23
D03034-1-7/8	7/8"	A	34	38	85	23
D03034-1-15/16	15/16"	A	36	38	85	41
D03034-1-1	1"	C	40	38	85	41
D03034-1-1 1/8	1 1/8"	B	42	42	85	52
D03034-1-1 3/16	1 3/16"	B	44	44	85	52
D03034-1-1 1/4	1 1/4"	B	44	44	85	52
D03034-1-1 5/16	1 5/16"	C	47	44	85	52
D03034-1-1 7/16	1 7/16"	C	51	44	85	52
D03034-1-1 1/2	1 1/2"	C	53	44	85	60

3/4" Impact sockets 12-point - normal ③

Type	A/F mm	Drawing	D1 mm	D2 mm	L mm	L2 mm
<i>Metrical</i>						
D063845013	13	A	23	38	50	12
D063845014	14	A	24	38	50	12
D063845015	15	A	26	38	50	12
D063845016	16	A	27	38	50	12
D063845017	17	A	28	38	50	12
D063845018	18	A	29	38	50	12
D063845019	19	A	30	38	50	14
D063845020	20	A	31	38	52	16
D063845021	21	A	32	38	52	16
D063845022	22	A	34	38	52	16
D063845023	23	A	35	38	52	16
D063845024	24	A	36	38	52	18
D063845025	25	B	38	38	52	18
D063845026	26	C	40	38	52	23
D063845027	27	C	40	38	52	23
D063845028	28	C	42	38	52	23
D063845029	29	C	43	38	52	23
D063845030	30	C	43	38	52	23
D063845031	31	C	44	38	56	24
D063845032	32	C	45	38	56	24
D063845033	33	C	46	38	56	24
D063845034	34	C	48	38	56	24
D063845035	35	C	50	38	56	24
D063845036	36	C	51	38	56	24
D063845037	37	C	52	38	56	24
D063845038	38	C	53	38	56	24
D063845039	39	C	55	38	62	28
D063845041	41	C	58	38	62	28
D063845042	42	C	61	38	62	28
D063845043	43	C	63	38	62	28

3/4"

3/4" Impact sockets 12-point - normal continued ①

Type	A/F mm	Drawing	D1 mm	D2 mm	L mm	L2 mm
<i>Metrical</i>						
D063845046	46	C	67	38	68	33
D063845050	50	C	71	38	70	34
D063845055	55	C	77	54	74	35
D063845056	56	C	77	54	74	35
D063845060	60	C	84	54	75	35
D063845063	63	C	86	54	78	37
D063845065	65	C	88	54	78	38
D063845067	67	C	90	54	80	40

3/4" Impact sockets - 12-point - long ②

Type	A/F mm	Drawing	D1 mm	D2 mm	L mm	L2 mm
<i>Metrical</i>						
D065847013	13	A	24.5	44	95	9
D065847014	14	A	25.5	44	95	11
D065847015	15	A	27	44	95	11
D065847016	16	A	28	44	95	11
D065847017	17	A	29.5	44	95	11
D065847018	18	A	31	44	95	13
D065847019	19	A	32	44	95	13
D065847020	20	A	34	44	95	13
D065847021	21	A	35	44	95	15
D065847022	22	A	37	44	95	15
D065847023	23	A	38	44	95	15
D065847024	24	A	39	44	95	18
D065847025	25	A	41	44	95	18
D065847026	26	A	42	44	95	18
D065847027	27	A	43	44	95	19
D065847028	28	B	44	44	95	19
D065847029	29	C	46	44	95	19
D065847030	30	C	47	44	95	21
D065847031	31	C	48	44	95	21
D065847032	32	C	49	44	95	22
D065847033	33	C	51	44	95	22
D065847034	34	C	52	44	95	22
D065847035	35	C	53	44	95	22
D065847036	36	C	54	44	95	24
D065847037	37	C	56	44	95	24
D065847038	38	C	57	44	95	24
D065847039	39	C	58	44	95	24
D065847040	40	C	59.5	44	95	24
D065847041	41	C	61	44	95	27
D065847042	42	C	62	44	95	27
D065847043	43	C	63.5	44	95	27
D065847044	44	C	64.5	44	95	27
D065847045	45	C	65.5	44	95	27

D065847046	46	C	66.5	44	100	30
D065847047	47	C	68	44	100	30
D065847048	48	C	69	44	100	30
D065847049	49	C	70	44	100	30
D065847050	50	C	71	54	100	32
D065847051	51	C	72	54	100	32
D065847052	52	C	74	54	100	32
D065847053	53	C	75	54	100	32
D065847054	54	C	77	54	100	32
D065847055	55	C	78	54	105	35
D065847056	56	C	79	54	105	35
D065847057	57	C	80	54	105	35
D065847058	58	C	81	54	105	37
D065847060	60	C	84	54	105	37
D065847063	63	C	87	54	105	37
D065847065	65	C	90	54	105	40
D065847067	67	C	92	54	105	40
D065847068	68	C	94	54	105	40
D065847070	70	C	96	54	105	40
D065847073	73	C	100	54	108	42
D065847075	75	C	102	64	108	42

3/4" Impact sockets thin wall - normal ③

Type	A/F mm	Drawing	D1 mm	D2 mm	L mm	L2 mm
<i>Metrical</i>						
D061141017	17	A	25.5	44	95	17
D061141019	19	A	28.5	44	95	17
D061141022	22	A	33.5	44	95	23
D061141024	24	A	36.5	44	95	40
D061141027	27	A	40.5	44	95	62
D061141030	30	A	43.5	44	95	62
D061141032	32	B	46.5	44	95	62
D061141033	33	B	47.5	44	95	62
D061141035	35	B	51	44	95	62
D061141036	36	B	52	44	95	62
D061141038	38	B	54	44	95	62
D061141041	41	B	57	44	95	60

3/4" Impact sockets extreme thin wall - long ④

Type	A/F mm	Drawing	D1 mm	D2 mm	L mm	L2 mm
<i>Metrical</i>						
D061142027	27	A	40	43	108	43
D061142032	32	B	45	45	108	43
D061142041	41	C	54.5	45	108	43



Standard socket

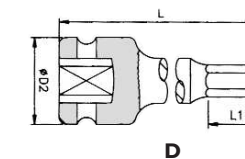
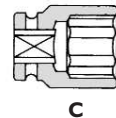
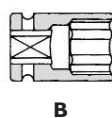
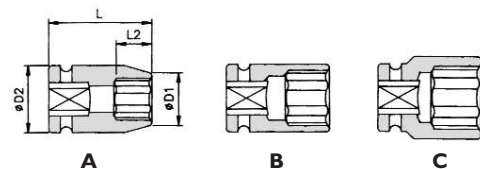

Impact sockets

3/4" + 1"



Hex head socket

3/4" Impact sockets for hex head 1

Type	A/F mm	Drawing	D2 mm	L mm	L2 mm
<i>Metrical</i>					
DO696510A	10	D	44	100	20
DO696512A	12	D	44	100	20
DO696514A	14	D	44	100	20
DO696517A	17	D	44	100	20
DO696519A	19	D	44	100	20
DO696522A	22	D	44	100	20
DO696524A	24	D	44	100	20
DO696527A	27	D	44	100	20

3/4" Impact sockets for Torx® internal 2

Type	A/F mm	Drawing	D2 mm	L mm	L1 mm
<i>Metrical</i>					
DO64742050	T50	F	44	100	5.0
DO64742055	T55	F	44	100	5.5
DO64742060	T60	F	44	100	8.0
DO64742070	T70	F	44	100	9.4
DO64742080	T80	F	44	100	10.5
DO64742090	T90	F	44	100	11.8
DO64742100	T100	F	44	100	13.1

3/4" Impact sockets 4-point 3

Type	A/F mm	Drawing	D1 mm	D2 mm	L mm	L2 mm
<i>Metrical</i>						
DO63045016	16	B	40	40	52	22
DO63045017	17	B	40	40	52	22
DO63045019	19	B	40	40	52	22
DO63045020	20	B	42	42	52	22
DO63045021	21	B	42	42	52	22

3/4" Impact sockets 8-point 4

Type	A/F mm	Drawing	D1 mm	D2 mm	L mm	L2 mm
<i>Metrical</i>						
DO63645019	19	B	41	41	52	15
DO63645024	24	C	46	44.5	52	20
DO63645027	27	C	53	44.5	56	24
DO63645030	30	C	60	44.5	60	28
DO63645032	32	C	60	44.5	60	28
DO63645038	38	C	70	44.5	64	32

1" Impact sockets - normal 5

Type	A/F mm	Drawing	D1 mm	D2 mm	L mm	L2 mm
<i>Metrical</i>						
DO4010-0-017	17	A	34	54	58	17
DO4010-0-018	18	A	35	54	58	17
DO4010-0-019	19	A	35.5	54	58	17
DO4010-0-020	20	A	36	54	58	17
DO4010-0-021	21	A	37.5	54	58	17
DO4010-0-022	22	A	40	54	58	17
DO4010-0-023	23	A	41	54	58	17
DO4010-0-024	24	A	42	54	58	17
DO4010-0-025	25	A	43	54	58	17
DO4010-0-026	26	A	44.5	54	58	17
DO4010-0-027	27	A	46	54	58	17
DO4010-0-028	28	A	47	54	58	17
DO4010-0-029	29	A	48	54	60	19
DO4010-0-030	30	A	50	54	60	21
DO4010-0-031	31	A	51	54	60	21
DO4010-0-032	32	A	52	54	60	21
DO4010-0-033	33	A	53	54	60	21
DO4010-0-034	34	C	55	54	60	21
DO4010-0-035	35	C	56	54	65	21
DO4010-0-036	36	C	57	54	65	30
DO4010-0-037	37	C	59	54	65	30
DO4010-0-038	38	C	59.5	54	67	30
DO4010-0-039	39	C	60	54	67	31
DO4010-0-040	40	C	62	54	67	31
DO4010-0-041	41	C	64	54	74	31
DO4010-0-042	42	C	65	54	74	36
DO4010-0-043	43	C	66	54	74	36
DO4010-0-045	45	C	68	54	74	36
DO4010-0-046	46	C	69.5	54	74	36
DO4010-0-047	47	C	72	54	74	36
DO4010-0-048	48	C	73	54	74	36
DO4010-0-050	50	C	74	54	80	42
DO4010-0-052	52	C	77	54	84	44
DO4010-0-053	53	C	78	54	84	44
DO4010-0-054	54	C	79	54	84	44
DO4010-0-055	55	C	81	54	84	44
DO4010-0-056	56	C	83	54	84	44
DO4010-0-057	57	C	83	54	84	44
DO4010-0-058	58	C	84	54	87	44
DO4010-0-060	60	C	87	54	87	44
DO4010-0-062	62	C	90	54	90	44
DO4010-0-063	63	C	91	54	90	44
DO4010-0-065	65	C	93	54	90	46
DO4010-0-070	70	C	100	54	96	51
DO4010-0-075	75	C	104	86	98	52
DO4010-0-080	80	C	109	86	100	52



1"

1" Impact sockets - normal continued 1

Type	A/F mm/inch	Drawing	D1 mm	D2 mm	L mm	L2 mm
<i>Metrical</i>						
DO4010-0-085	85	C	115	86	100	52
DO4010-0-090	90	C	119	86	105	55
DO4010-0-095	95	C	130	86	105	55
DO4010-0-100	100	C	136	95	105	55

Inch

DO4010-0-1 1/8	1 1/8"	A	46	51	58	19
DO4010-0-1 5/16	1 5/16"	C	53	52	62	21
DO4010-0-1 7/16	1 7/16"	C	56	52	62	26
DO4010-0-1 1/2	1 1/2"	C	58	52	62	26
DO4010-0-1 11/16	1 11/16"	C	65	52	64	27
DO4010-0-1 7/8	1 7/8"	C	70	58	66	28
DO4010-0-2 1/16	2 1/16"	C	75	58	70	31
DO4010-0-2 1/4	2 1/4"	C	84	62	75	34
DO4010-0-2 7/16	2 7/16"	C	89	62	78	35
DO4010-0-2 1/2	2 1/2"	C	91	62	80	36
DO4010-0-2 7/8	2 7/8"	C	102	62	87	41

1" Impact sockets - long 2

Type	A/F mm	Drawing	D1 mm	D2 mm	L mm	L2 mm
<i>Metrical</i>						
DO4010-1-017	17	A	34	54	100	21
DO4010-1-018	18	A	34	54	100	21
DO4010-1-019	19	A	35.5	54	100	21
DO4010-1-020	20	A	36.5	54	100	21
DO4010-1-021	21	A	37.5	54	100	21
DO4010-1-022	22	A	40	54	100	21
DO4010-1-023	23	A	41	54	100	21
DO4010-1-024	24	A	42	54	100	21
DO4010-1-025	25	A	43	54	100	21
DO4010-1-026	26	A	44.5	54	100	21
DO4010-1-027	27	A	46	54	100	23
DO4010-1-028	28	A	47	54	100	23
DO4010-1-029	29	A	48	54	100	50
DO4010-1-030	30	A	50	54	100	50
DO4010-1-031	31	A	51	54	100	50
DO4010-1-032	32	A	52	54	100	50

1" Impact sockets - long continued 2

Type	A/F mm/inch	Drawing	D1 mm	D2 mm	L mm	L2 mm
<i>Metrical</i>						
DO4010-1-033	33	A	53	53	100	50
DO4010-1-034	34	C	55	54	100	50
DO4010-1-035	35	C	56	54	100	50
DO4010-1-036	36	C	57	54	100	64
DO4010-1-037	37	C	57	54	100	64
DO4010-1-038	38	C	59.5	54	100	64
DO4010-1-039	39	C	60	54	100	64
DO4010-1-040	40	C	62	54	100	64
DO4010-1-041	41	C	64	54	100	64
DO4010-1-042	42	C	65	54	100	64
DO4010-1-046	46	C	69.5	54	100	62
DO4010-1-047	47	C	73	54	100	62
DO4010-1-048	48	C	74	54	100	62
DO4010-1-050	50	C	75	54	100	62
DO4010-1-054	54	C	79	54	100	60
DO4010-1-055	55	C	81	54	100	60
DO4010-1-056	56	C	83	54	100	65
DO4010-1-058	58	C	84	54	105	65
DO4010-1-060	60	C	87	54	105	77
DO4010-1-065	65	C	93	54	120	80
DO4010-1-070	70	C	99	54	125	80
DO4010-1-075	75	C	104	86	135	87
DO4010-1-080	80	C	109	86	135	87
DO4010-1-085	85	C	115	86	140	90
DO4010-1-090	90	C	125	86	140	90
DO4010-1-095	95	C	130	86	140	90
DO4010-1-100	100	C	137	95	140	90
DO4010-1-105	105	C	143	95	155	100
DO4010-1-110	110	C	147	95	155	100
DO4010-1-115	115	C	152	95	155	100

Inch

DO4010-1-15/16	15/16"	A	40	51	90	21
DO4010-1-1 1/16	1 1/16"	A	44	51	90	23
DO4010-1-1 3/16	1 3/16"	A	48	51	90	40
DO4010-1-1 5/16	1 5/16"	C	53	52	90	40
DO4010-1-1 1/2	1 1/2"	C	58	52	92	54

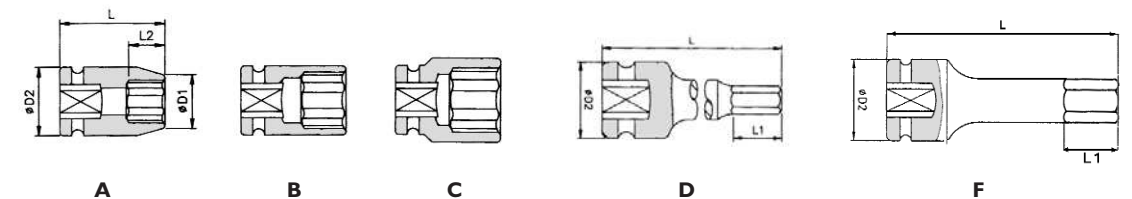

Impact sockets

1"

1" Impact sockets - 12-point - normal ①

Type	A/F mm	Drawing	D1 mm	D2 mm	L mm	L2 mm
<i>Metrical</i>						
DO65855016	16	A	32	54	60	11
DO65855017	17	A	34	54	60	11
DO65855018	18	A	35	54	60	13
DO65855019	19	A	36	54	60	13
DO65855020	20	A	37	54	60	13
DO65855021	21	A	38	54	60	15
DO65855022	22	A	39	54	60	15
DO65855023	23	A	40	54	60	15
DO65855024	24	A	41	54	60	18
DO65855025	25	A	43	54	60	18
DO65855026	26	A	44.5	54	60	18
DO65855027	27	A	45	54	60	19
DO65855028	28	A	46.5	54	62	19
DO65855029	29	A	48	54	62	19
DO65855030	30	A	50	54	62	21
DO65855031	31	A	51	54	62	21
DO65855032	32	A	52	54	62	22
DO65855033	33	A	53	54	62	22
DO65855034	34	C	55	54	62	22
DO65855035	35	C	56	54	65	22
DO65855036	36	C	57	54	67	24
DO65855037	37	C	59	54	67	24
DO65855038	38	C	60	54	67	24
DO65855039	39	C	61	54	70	24
DO65855040	40	C	62	54	70	24
DO65855041	41	C	63.5	54	70	27
DO65855042	42	C	65	54	74	27
DO65855043	43	C	66	54	74	27
DO65855044	44	C	67	54	74	27
DO65855045	45	C	68	54	74	27
DO65855046	46	C	70	58	76	30
DO65855047	47	C	71.5	58	76	30
DO65855048	48	C	72.5	58	76	30
DO65855050	50	C	75	62	80	32
DO65855051	51	C	76	62	80	32
DO65855052	52	C	77	62	84	32
DO65855053	53	C	78	62	84	32
DO65855054	54	C	80	62	84	32
DO65855055	55	C	81	62	84	35
DO65855056	56	C	82	62	84	35
DO65855057	57	C	84	62	84	35

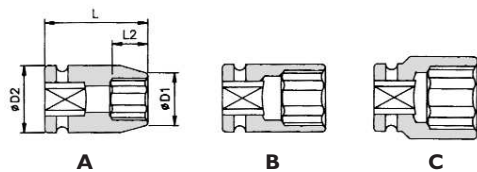

DO65855058	58	C	85	62	87	37
DO65855060	60	C	87	62	87	37
DO65855062	62	C	89	62	87	37
DO65855063	63	C	90	62	87	37
DO65855065	65	C	93	62	90	40
DO65855067	67	C	96	62	92	40
DO65855070	70	C	100	62	96	40
DO65855075	75	C	106	86	98	42
DO65855076	76	C	107	86	100	45
DO65855077	77	C	109	86	100	45
DO65855078	78	C	110	86	100	45
DO65855080	80	C	112	86	100	45
DO65855085	85	C	118	86	105	52
DO65855090	90	C	125	86	105	52
DO65855095	95	C	131	86	105	52
DO65855100	100	C	137	86	110	58
DO65855105	105	C	143	95	110	58
DO65855110	110	C	149	95	115	62
DO65855115	115	C	155	95	115	62

1" Impact sockets - 12-point - long ②

Type	A/F mm	Drawing	D1 mm	D2 mm	L mm	L2 mm
<i>Metrical</i>						
DO65857016	16	A	32	54	100	11
DO65857017	17	A	34	54	100	11
DO65857018	18	A	35	54	100	13
DO65857019	19	A	36	54	100	13
DO65857020	20	A	37	54	100	13
DO65857021	21	A	38	54	100	15
DO65857022	22	A	39	54	100	15
DO65857023	23	A	40	54	100	15
DO65857024	24	A	41	54	100	18
DO65857025	25	A	43	54	100	18
DO65857026	26	A	44.5	54	100	18
DO65857027	27	A	45	54	100	19
DO65857028	28	A	46.5	54	100	19
DO65857029	29	A	48	54	100	19
DO65857030	30	A	50	54	100	21
DO65857031	31	A	51	54	100	21
DO65857032	32	A	52	54	100	22
DO65857033	33	A	53	54	100	22
DO65857034	34	C	55	54	100	22
DO65857035	35	C	56	54	100	22
DO65857036	36	C	57	54	100	24
DO65857037	37	C	59	54	100	24
DO65857038	38	C	60	54	100	24
DO65857039	39	C	61	54	100	24
DO65857040	40	C	62	54	100	24
DO65857041	41	C	63.5	54	100	27



1"

DO65857042	42	C	65	54	100	27
DO65857043	43	C	66	54	100	27
DO65857044	44	C	67	54	100	27
DO65857045	45	C	68	54	100	27
DO65857046	46	C	70	58	100	30
DO65857047	47	C	71.5	58	100	30
DO65857048	48	C	72.5	58	100	30
DO65857050	50	C	75	62	100	32
DO65857051	51	C	76	62	100	32
DO65857052	52	C	77	62	100	32
DO65857053	53	C	78	62	100	32
DO65857054	54	C	80	62	100	32
DO65857055	55	C	81	62	100	35
DO65857056	56	C	82	62	105	35
DO65857057	57	C	84	62	105	35
DO65857058	58	C	85	62	105	37
DO65857060	60	C	87	62	120	37
DO65857062	62	C	89	62	120	37
DO65857063	63	C	90	62	120	37
DO65857065	65	C	93	62	125	40
DO65857067	67	C	96	62	125	40
DO65857070	70	C	100	62	125	40
DO65857075	75	C	106	86	135	42
DO65857076	76	C	107	86	135	45
DO65857077	77	C	109	86	135	45
DO65857078	78	C	110	86	135	45
DO65857080	80	C	112	86	135	45
DO65857085	85	C	118	86	140	52
DO65857090	90	C	125	86	140	52
DO65857095	95	C	131	86	140	52
DO65857100	100	C	137	86	140	58
DO65857105	105	C	143	95	155	58
DO65857110	110	C	149	95	155	62
DO65857115	115	C	155	95	155	62

1" Impact sockets thin wall - long ①

Type	A/F mm	Drawing	D1 mm	D2 mm	L mm	L2 mm
<i>Metrical</i>						
DO61151019	19	A	33	54	100	21
DO61151024	24	A	38	54	100	21
DO61151027	27	A	42.5	54	100	23
DO61151028	28	A	43	54	100	23
DO61151030	30	A	45	54	100	50
DO61151032	32	A	47	54	100	50
DO61151033	33	A	49	54	100	50
DO61151036	36	A	52	54	100	64

1" Impact sockets - extra long ②

Type	A/F mm	Drawing	D1 mm	D2 mm	L mm	L2 mm
<i>Metrical</i>						
DO60559024	24	B	42	54	270	24
DO60559026	26	B	44	54	270	26
DO60559027	27	B	45	54	270	27
DO60559030	30	B	50	54	270	30
DO60559032	32	B	52	54	270	32
DO60559033	33	B	52	54	270	32

1" Impact sockets for hex head ③

Type	A/F mm	Drawing	D2 mm	L mm	L2 mm
<i>Metrical</i>					
DO696610A	10	D	54	100	20
DO696612A	12	D	54	100	20
DO696614A	14	D	54	100	20
DO696617A	17	D	54	100	20
DO696619A	19	D	54	100	20
DO696622A	22	D	54	100	20
DO696622B	22	D	54	140	20
DO696624A	24	D	54	100	20
DO696627A	27	D	54	100	20
DO696630A	30	D	54	100	20
DO696632A	32	D	54	100	20

1" Impact sockets 4-point ④

Type	A/F mm	Drawing	D1 mm	D2 mm	L mm	L2 mm
<i>Metrical</i>						
DO63055017	17	B	52	52	57	24
DO63055019	19	B	52	52	57	24
DO63055020	20	B	52	52	57	24
DO63055021	21	B	52	52	57	24

1" Pin and ring

DO1100-0-000 1"

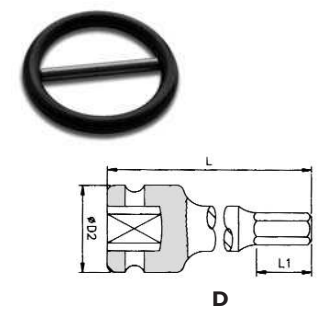

Impact sockets

1" + 1½"



1½" Impact socket, normal

1" Impact sockets 8-point ①

Type	A/F mm	Drawing	D1 mm	D2 mm	L mm	L2 mm
<i>Metrical</i>						
D063655019	19	A	47	54	58	16
D063655024	24	A	52	54	58	16
D063655027	27	C	58	54	68	30
D063655030	30	C	61	54	70	32
D063655032	32	C	61	54	70	32
D063655035	35	C	66.5	58	70	32
D063655038	38	C	73	58	70	32
D063655046	46	C	86	62	80	42

1½" Impact sockets - normal ②

Type	A/F mm	Drawing	D1 mm	D2 mm	L mm	L2 mm
<i>Metrical</i>						
D05112-0-030	30	A	56	86	78	23
D05112-0-032	32	A	58	86	78	23
D05112-0-035	35	A	62	86	78	23
D05112-0-036	36	A	64	86	78	23
D05112-0-037	37	A	65	86	78	23
D05112-0-038	38	A	66	86	78	24
D05112-0-040	40	A	68	86	78	24
D05112-0-041	41	A	70	86	80	26
D05112-0-045	45	A	75	86	84	27
D05112-0-046	46	A	76	86	84	27
D05112-0-047	47	A	77	86	84	29
D05112-0-048	48	A	79	86	84	29
D05112-0-050	50	A	81	87	87	29
D05112-0-052	52	A	83	86	87	31
D05112-0-054	54	B	86	86	90	36
D05112-0-055	55	B	86	86	90	36
D05112-0-056	56	B	86	86	92	38
D05112-0-058	58	C	92	86	92	38
D05112-0-060	60	C	93	86	92	38
D05112-0-061	61	C	95	86	95	40
D05112-0-062	62	C	96	86	95	40
D05112-0-065	65	C	97	86	95	40
D05112-0-068	68	C	104	86	100	43
D05112-0-070	70	C	105	86	100	43
D05112-0-072	72	C	108	86	103	45
D05112-0-075	75	C	110	86	103	45
D05112-0-078	78	C	115	86	110	50

D05112-0-080	80	C	116	86	110	50
D05112-0-085	85	C	125	86	118	55
D05112-0-090	90	C	130	86	118	55
D05112-0-095	95	C	137	95	118	55
D05112-0-100	100	C	140	95	125	58
D05112-0-105	105	C	150	95	125	58
D05112-0-110	110	C	156	95	125	58
D05112-0-115	115	C	160	95	135	65
D05112-0-125	125	C	175	95	135	65

1½" Impact sockets - long ③

Type	A/F mm	Drawing	D1 mm	D2 mm	L mm	L2 mm
<i>Metrical</i>						
D05112-1-041	41	A	70	86	115	30
D05112-1-042	42	A	72	86	115	32
D05112-1-046	46	A	78	86	115	34
D05112-1-050	50	A	81	86	135	36
D05112-1-054	54	B	86	86	140	39
D05112-1-055	55	B	86	86	140	39
D05112-1-060	60	C	94	86	150	41
D05112-1-063	63	C	97	86	150	43
D05112-1-065	65	C	100	86	150	45
D05112-1-070	70	C	105	86	160	47
D05112-1-075	75	C	110	86	170	51
D05112-1-080	80	C	116	86	170	51
D05112-1-085	85	C	125	86	170	56

1½" Impact sockets for hex head ④

Type	A/F mm	Drawing	D2 mm	L mm	L1 mm
<i>Metrical</i>					
D064865019	19	D	86	120	20
D064865022	22	D	86	120	20
D064865024	24	D	86	120	20
D064865027	27	D	86	120	20
D064865030	30	D	86	120	20
D064865032	32	D	86	120	20
D064865036	36	D	86	120	20

1½" Pin and ring

D01112-0-000 1½"

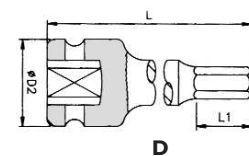

2½" + #5



#5 Spline drive socket

2½" Impact sockets - normal ①

Type	A/F mm	Drawing	D1 mm	D2 mm	L mm	L2 mm
<i>Metrical</i>						
D06212-0-075	75	A	118	127	140	46
D06212-0-077	77	A	122	127	140	48
D06212-0-080	80	A	124	127	140	51
D06212-0-085	85	C	130	127	140	51
D06212-0-090	90	C	136	127	145	54
D06212-0-095	95	C	146	127	145	54
D06212-0-100	100	C	149	127	150	57
D06212-0-105	105	C	155	127	155	61
D06212-0-110	110	C	161	127	160	64
D06212-0-115	115	C	167	127	165	67
D06212-0-120	120	C	174	127	170	71
D06212-0-125	125	C	181	127	175	75
D06212-0-130	130	C	188	127	175	75
D06212-0-135	135	C	195	127	180	79
D06212-0-140	140	C	202	127	180	79
D06212-0-145	145	C	208	127	185	83
D06212-0-150	150	C	215	127	185	87
D06212-0-155	155	C	221	127	190	91
D06212-0-160	160	C	227	127	190	91
D06212-0-165	165	C	234	127	195	95
D06212-0-170	170	C	241	127	195	100
D06212-0-175	175	C	248	127	200	105
D06212-0-180	180	C	254	127	200	105
D06212-0-185	185	C	258	152	210	110
D06212-0-190	190	C	265	152	210	110
D06212-0-200	200	C	275	152	220	115

#5 Spline drive - normal, 6-point ②

Type	A/F mm	Drawing	D1 mm	D2 mm	L mm	L2 mm
<i>Metrical</i>						
D067005027	27	A	48	55	80	24
D067005030	30	A	51	55	80	24
D067005032	32	B	55	55	80	24
D067005041	41	C	67	55	80	24
D067005050	50	C	75	65	98	38
D067005055	55	C	79	65	98	38
D067005060	60	C	86	65	106	46
D067005070	70	C	99	86	117	57

2½" Pin and ring

D02112-0-000 2½"

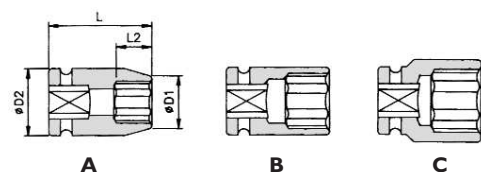
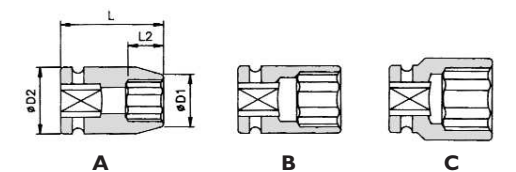

Various

Extension bars & Universal joints



Extension bar with steel ball



Universal joint

Extension bars with pin hole ①

Type	Square-drive	Drawing	D mm	L mm
DO7014-0-050	1/4"	B	13	50
DO7014-0-100	1/4"	B	13	100
DO7014-0-150	1/4"	B	13	150
DO7038-0-075	3/8"	B	19	75
DO7038-0-100	3/8"	B	19	100
DO7038-0-125	3/8"	B	19	125
DO7038-0-150	3/8"	B	19	150
DO7038-0-200	3/8"	B	19	200
DO7038-0-250	3/8"	B	19	250
DO7012-0-075	1/2"	B	25	75
DO7012-0-100	1/2"	B	25	100
DO7012-0-125	1/2"	B	25	125
DO7012-0-150	1/2"	B	25	150
DO7012-0-175	1/2"	B	25	175
DO7012-0-250	1/2"	B	25	250
DO7012-0-300	1/2"	B	25	300
DO7012-0-460	1/2"	B	25	460
DO7012-0-610	1/2"	B	25	610
DO7012-0-915	1/2"	B	25	915
DO7034-0-075	3/4"			75
DO7034-0-100	3/4"	B	44	100
DO7034-0-125	3/4"			125
DO7034-0-150	3/4"	B	44	150
DO7034-0-175	3/4"	B	44	175
DO7034-0-200	3/4"	B	44	200
DO7034-0-250	3/4"	B	44	250
DO7034-0-300	3/4"	B	44	300
DO7034-0-330	3/4"	B	44	330
DO7034-0-400	3/4"	B	44	400
DO7100-0-075	1"	B	54	75
DO7100-0-100	1"	B	54	100
DO7100-0-125	1"	B	54	125
DO7100-0-150	1"	B	54	150
DO7100-0-175	1"	B	54	175
DO7100-0-200	1"	B	54	200
DO7100-0-250	1"	B	54	250
DO7100-0-300	1"	B	54	300
DO7100-0-330	1"	B	54	330
DO7100-0-400	1"	B	54	400

DO7112-0-125	1 1/2"	B	86	125
DO7112-0-250	1 1/2"	B	86	250
DO7112-0-500	1 1/2"	B	86	500
DO7271-0-125	2 1/2"	B	127	125
DO7212-0-250	2 1/2"	B	127	250
DO7212-0-500	2 1/2"	B	127	500

* Pin and ring are not standard on the extension bars with pin hole. Please order separately (see page 184).

Extension bars with steel ball ②

Type	Square-drive	Drawing	D2 mm	L mm
DO6862075	3/8"	A	19	75
DO6862100	3/8"	A	19	100
DO6862125	3/8"	A	19	125
DO6862150	3/8"	A	19	150
DO6862250	3/8"	A	19	250
DO6863075	1/2"	A	25	75
DO6863100	1/2"	A	25	100
DO6863125	1/2"	A	25	125
DO6863250	1/2"	A	25	250

Universal joints with pin hole ③

Type	Square-drive	Drawing	D2 mm	L mm
DO9014-0-000	1/4"	B	16	43
DO9038-0-000	3/8"	B	21	50
DO9012-0-000	1/2"	B	29	60
DO9034-0-000	3/4"	B	44	105
DO9100-0-000	1"	B	54	133
DO9112-0-000	1 1/2"	C	86	182
DO9212-0-000	2 1/2"	C	152	248

* Pin and ring are not standard on the universal joints with pin hole. Please order separately (see page 184).

Universal joints with steel ball ④

Type	Square-drive	Drawing	D2 mm	D1 mm	L mm
DO6781F1T	1/4"	A	16	-	43
DO6782F2T	3/8"	A	21	24	50
DO6783F3T	1/2"	A	29	32	60
DO6784F4T	3/4"	A	44	-	105

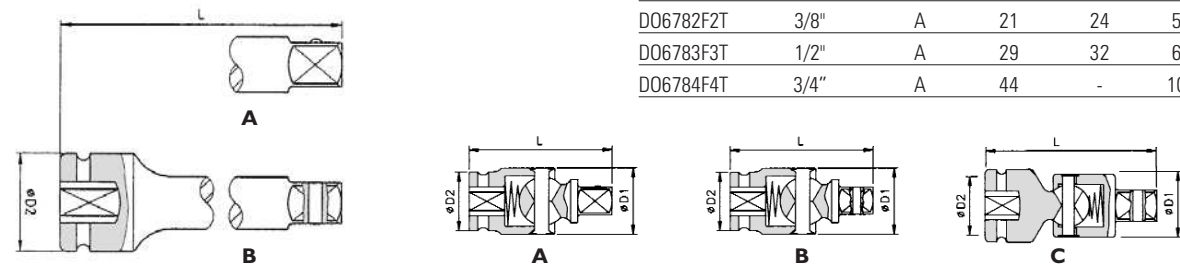

Adapters



Adapter

Adapters with pin hole ①

Type	Square-drive	Outside	Drawing	D2 mm	L mm
DO8014-0-038	1/4"	3/8"	A		
DO8038-0-014	3/8"	1/4"	A	22	32
DO8038-0-012	3/8"	1/2"	A	22	36
DO8012-0-034	1/2"	3/4"	A	30	48
DO8012-0-038	1/2"	3/8"	A	26	38
DO8034-0-012	3/4"	1/2"	A	40	58
DO8034-0-100	3/4"	1"	A	40	63
DO8100-0-034	1"	3/4"	A	52	80
DO8100-0-112	1"	1 1/2"	A	52	91
DO8112-0-100	1 1/2"	1"	A	84	95
DO8134-0-112	1 3/4"	1 1/2"	A	127	153
DO8212-0-112	2 1/2"	1 1/2"	A	127	138

* Pin and ring are not standard on the adapters with pin hole. Please order separately (see page 184).

Adapters with steel ball ②

Type	Square-drive	Outside	Drawing	D2 mm	L mm
DO6815L3T	3/4"	1/2"	B	44	56
DO6822F3T	3/8"	1/2"	B	22	36
DO6823F2T	1/2"	3/8"	B	25	38

Quickchange adapters ③

Type	Drive-in	Drive-out
DO69110C08	1/4"	1/4"
DO69111C12	3/8"	3/8"
DO69112C12	1/2"	3/8"
DO69112C16	1/2"	1/2"
DO69114C24	3/4"	3/4"
DO69115C24	1"	3/4"
DO69115C32	1"	1"

Impact bit holders ④

Type	Square-drive	Hex chuck	L mm
DO69121008	3/8"	1/4"	32
DO69121010	3/8"	5/16"	37
DO69121016	3/8"	1/2"	37
DO69122008	1/2"	1/4"	40
DO69122010	1/2"	5/16"	40
DO69122016	1/2"	1/2"	40



Quickchange adapters

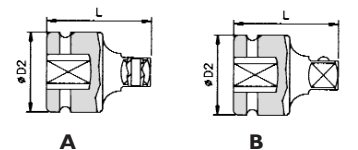

Sleeve drive sockets

3/8" - only for impulse wrenches



Sleeve drive power socket, normal size



Sleeve drive power socket, long size

3/8" Sleeve drive power sockets - long ①

Type	A/F mm	Drawing	D1 mm	D2 mm	L mm	L2 mm
<i>Metrical</i>						
DO60913006	6	D	10.5	22	100	4
DO60913008	8	D	12.5	22	100	8
DO60913010	10	D	15	22	100	8
DO60913012	12	D	18	22	100	9
DO60913013	13	D	19	22	100	9
DO60913014	14	D	20	22	100	9
DO60913015	15	D	21	22	100	11
DO60913016	16	D	22.5	22	100	11
DO60913017	17	D	24	22	100	11
DO60914006	6	D	10.5	22	150	4
DO60914008	8	D	12.5	22	150	8
DO60914010	10	D	15	22	150	8
DO60914012	12	D	18	22	150	9
DO60914013	13	D	19	22	150	9
DO60914014	14	D	20	22	150	9
DO60914015	15	D	21	22	150	11
DO60914016	16	D	22.5	22	150	11
DO60914017	17	D	24	22	150	11
DO60915006	6	D	10.5	22	200	4
DO60915008	8	D	12.5	22	200	8
DO60915010	10	D	15	22	200	8
DO60915012	12	D	18	22	200	9
DO60915013	13	D	19	22	200	9
DO60915014	14	D	20	22	200	9
DO60915015	15	D	21	22	200	11
DO60915016	16	D	22.5	22	200	11
DO60915017	17	D	24	22	200	11

3/8" Sleeve drive power sockets - normal ②

Type	A/F mm	Drawing	D1 mm	D2 mm	L mm	L2 mm
<i>Metrical</i>						
DO60910010	10	A	16	19	43	8
DO60910011	11	A	17.5	19	43	9
DO60910012	12	B	19	19	43	9
DO60910013	13	A	20	22	43	9
DO60910014	14	A	21	22	43	9
DO60910015	15	B	22	22	43	11
DO60910016	16	C	24	22	43	11
DO60910017	17	C	25	22	43	11
DO60910018	18	C	26	22	43	11
DO60910019	19	C	27.5	22	43	11
DO60910021	21	C	30	22	43	13

3/8" Sleeve drive power sockets - Torx® external ③

Type	A/F mm	Drawing	D1 mm	D2 mm	L mm	L2 mm
<i>Metrical</i>						
DO66910005	E5	A	8	19	43	4.5
DO66910006	E6	A	9	19	43	5
DO66910007	E7	A	9.5	19	43	6
DO66910008	E8	A	11	19	43	6.5
DO66910010	E10	A	13	19	43	7.5
DO66910011	E11	A	14	19	43	8
DO66910012	E12	A	15.5	19	43	8.5
DO66910014	E14	A	17.5	22	43	10
DO66910016	E16	A	18.5	22	43	11

Torx® is a trademark of Textron.



3/8"

3/8" Magnetic sleeve drive power sockets - long ①

Type	A/F mm	Drawing	D1 mm	D2 mm	L mm	L2 mm
<i>Metrical</i>						
DO6091P006	6	D	11	19	100	3
DO6091P007	7	D	12	19	100	3
DO6091P008	8	D	13	19	100	4
DO6091P009	9	D	15	19	100	4
DO6091P010	10	D	16	19	100	4
DO6091P011	11	D	17.5	19	100	5
DO6091P012	12	D	18.5	19	100	5
DO6091P013	13	D	20	22	100	6
DO6091P014	14	D	21	22	100	6
DO6091P015	15	D	22	22	100	7
DO6091P016	16	D	24	22	100	7
DO6091P017	17	D	25	22	100	7

DO6091R006	6	D	11	19	150	3
DO6091R007	7	D	12	19	150	3
DO6091R008	8	D	13	19	150	4
DO6091R009	9	D	15	19	150	4
DO6091R010	10	D	16	19	150	4
DO6091R011	11	D	17.5	19	150	5
DO6091R012	12	D	18.5	19	150	5
DO6091R013	13	D	20	22	150	6
DO6091R014	14	D	21	22	150	6
DO6091R015	15	D	22	22	150	7
DO6091R016	16	D	24	22	150	7
DO6091R017	17	D	25	22	150	7

DO6091T006	6	D	11	19	200	3
DO6091T007	7	D	12	19	200	3
DO6091T008	8	D	13	19	200	4
DO6091T009	9	D	15	19	200	4
DO6091T010	10	D	16	19	200	4
DO6091T011	11	D	17.5	19	200	5
DO6091T012	12	D	18.5	19	200	5
DO6091T013	13	D	20	22	200	6
DO6091T014	14	D	21	22	200	6
DO6091T015	15	D	22	22	200	7
DO6091T016	16	D	24	22	200	7
DO6091T017	17	D	25	22	200	7

3/8" Torx® Sleeve drive power sockets - internal ②

Type	A/F mm	Drawing	L1 mm	D2 mm	L mm
<i>Metrical</i>					
DO68811009	T9	F	2.0	22	75
DO68811010	T10	F	2.8	22	75
DO68811015	T15	F	2.8	22	75
DO68811020	T20	F	2.8	22	75
DO68811025	T25	F	3.0	22	75
DO68811027	T26	F	3.0	22	75
DO68811030	T30	F	3.8	22	75
DO68811040	T40	F	3.8	22	75
DO68811045	T45	F	4.3	22	75
DO68811047	T47	F	5.0	22	75
DO68811050	T50	F	5.0	22	75
DO68811055	T55	F	5.0	22	75

3/8" Sleeve drive power sockets for hex head ③

Type	A/F mm	Drawing	L1 mm	D2 mm	L mm
<i>Metrical</i>					
DO68916003	3	F	11	22	75
DO68916004	4	F	11	22	75
DO68916005	5	F	11	22	75
DO68916006	6	F	11	22	75
DO68916007	7	F	16	22	75
DO68916008	8	F	16	22	75
DO68916009	9	F	16	22	75
DO68916010	10	F	16	22	75
DO68916011	11	F	16	22	75
DO68916012	12	F	16	22	75
DO68916013	13	F	16	22	75
DO68916014	14	F	16	22	75
DO68916015	15	F	16	22	75
DO68916016	16	F	16	22	75

Reduced Vibration!

Action sleeve drive power sockets are supported with an O-ring on the axle of the impulse wrench, giving a tighter fit on the tool.



Sleeve drive power sockets guarantee:

- Torque improvement
- Reduced vibration
- Reduced noise level
- Reduced wear

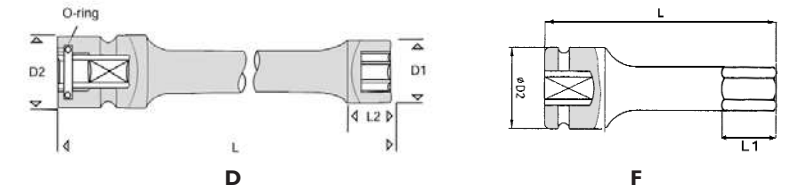
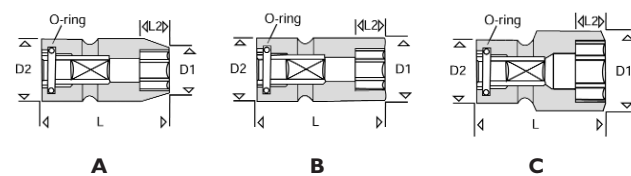

Sleeve drive sockets

1/2" - only for impulse wrenches

1/2" Sleeve drive power sockets - normal ①

Type	A/F mm	Drawing	D1 mm	D2 mm	L mm	L2 mm
<i>Metrical</i>						
DO60920012	12	A	20	25	52	12
DO60920013	13	A	21	25	52	12
DO60920014	14	A	22.5	25	52	12
DO60920015	15	A	23.7	30	52	12
DO60920016	16	A	25	30	52	12
DO60920017	17	A	26	30	52	12
DO60920018	18	A	27.5	30	52	12
DO60920019	19	A	28.7	30	52	12
DO60920021	21	B	30	30	52	12
DO60920022	22	C	32	30	52	12
DO60920023	23	C	32	30	52	12
DO60920024	24	C	35	30	52	12
DO60920025	25	C	36	30	57	12
DO60920027	27	C	39	30	57	12
DO60920030	30	C	42	30	62	12
DO60920032	32	C	44	30	62	12

1/2" Sleeve drive power sockets Torx® external ②

Type	A/F mm	Drawing	D1 mm	D2 mm	L mm	L2 mm
<i>Metrical</i>						
DO66920010	E10	A	14	25	52	7.5
DO66920011	E11	A	15	25	52	8
DO66920012	E12	A	16	25	52	8.5
DO66920014	E14	A	18	25	52	10
DO66920016	E16	A	20	25	52	11
DO66920018	E18	A	22	25	52	12.5
DO66920020	E20	A	25	30	52	14
DO66920022	E22	A	27	30	52	15
DO66920024	E24	A	29	30	52	16.5

Torx® is a trademark of Textron.

1/2" Sleeve drive power sockets - long ③

Type	A/F mm	Drawing	D1 mm	D2 mm	L mm	L2 mm
<i>Metrical</i>						
DO60923010	10	D	17	25	100	12
DO60923012	12	D	19.5	25	100	12
DO60923013	13	D	20.5	25	100	12
DO60923014	14	D	21.5	25	100	12
DO60923015	15	D	22.5	25	100	12
DO60923017	17	D	25	25	100	13
DO60923019	19	D	28	25	100	13
DO60924010	10	D	17	25	150	12
DO60924012	12	D	19.5	25	150	12
DO60924013	13	D	20.5	25	150	12
DO60924014	14	D	21.5	25	150	12
DO60924015	15	D	22.5	25	150	12
DO60924017	17	D	25	25	150	13
DO60924019	19	D	28	25	150	13
DO60925010	10	D	17	25	200	12
DO60925012	12	D	19.5	25	200	12
DO60925013	13	D	20.5	25	200	12
DO60925014	14	D	21.5	25	200	12
DO60925015	15	D	22.5	25	200	12
DO60925017	17	D	25	25	200	13
DO60925019	19	D	28	25	200	13



1/2"

1/2" Magnetic sleeve drive power sockets - long ①

Type	A/F mm	Drawing	D1 mm	D2 mm	L mm	L2 mm
<i>Metrical</i>						
DO6092P010	10	D	17.5	25	100	4
DO6092P011	11	D	18.5	25	100	5
DO6092P012	12	D	20	25	100	5
DO6092P013	13	D	21	25	100	6
DO6092P014	14	D	22.5	25	100	6
DO6092P015	15	D	23.5	30	100	7
DO6092P016	16	D	25	30	100	7
DO6092P017	17	D	26	30	100	7
DO6092P018	18	D	27.5	30	100	8
DO6092P019	19	D	28.5	30	100	8
DO6092R010	10	D	17.5	25	150	12
DO6092R011	11	D	18.5	25	150	12
DO6092R012	12	D	20	25	150	12
DO6092R013	13	D	21	25	150	12
DO6092R014	14	D	22.5	25	150	12
DO6092R015	15	D	23.5	30	150	12
DO6092R016	16	D	25	30	150	13
DO6092R017	17	D	26	30	150	13
DO6092R018	18	D	27.5	30	150	13
DO6092R019	19	D	28.5	30	150	13
DO6092T010	10	D	17.5	25	200	12
DO6092T011	11	D	18.5	25	200	12
DO6092T012	12	D	20	25	200	12
DO6092T013	13	D	21	25	200	12
DO6092T014	14	D	22.5	25	200	12
DO6092T015	15	D	23.5	30	200	12
DO6092T016	16	D	25	30	200	13
DO6092T017	17	D	26	30	200	13
DO6092T018	18	D	27.5	30	200	13
DO6092T019	19	D	28.5	30	200	13



1/2" Torx® sleeve drive power sockets - internal ②

Type	A/F mm	Drawing	L1 mm	D2 mm	L mm
<i>Metrical</i>					
DO68821020	T20	F	2.8	25	75
DO68821025	T25	F	3.0	25	75
DO68821027	T27	F	3.0	25	75
DO68821030	T30	F	3.8	25	75
DO68821040	T40	F	3.8	25	75
DO68821045	T45	F	4.3	25	75
DO68821047	T47	F	5.0	25	75
DO68821050	T50	F	5.0	25	75
DO68821055	T55	F	5.5	25	75
DO68821060	T60	F	8.0	25	75
DO68821070	T70	F	9.4	25	75
DO68821080	T80	F	10.5	25	75
DO68821090	T90	F	11.8	25	75
DO68821100	T100	F	13.1	25	75

1/2" Sleeve drive power sockets for hex head ③

Type	A/F mm	Drawing	L1 mm	D2 mm	L mm
<i>Metrical</i>					
DO68925003	3	F	11	25	75
DO68925004	4	F	11	25	75
DO68925005	5	F	15	25	75
DO68925006	6	F	15	25	75
DO68925007	7	F	20	25	75
DO68925008	8	F	25	25	75
DO68925009	9	F	25	25	75
DO68925010	10	F	25	25	75
DO68925011	11	F	25	25	75
DO68925012	12	F	25	25	75
DO68925013	13	F	25	25	75
DO68925014	14	F	25	25	75
DO68925015	15	F	25	25	75
DO68925016	16	F	25	25	75
DO68925017	17	F	25	25	75
DO68925018	18	F	25	25	75
DO68925019	19	F	25	25	75

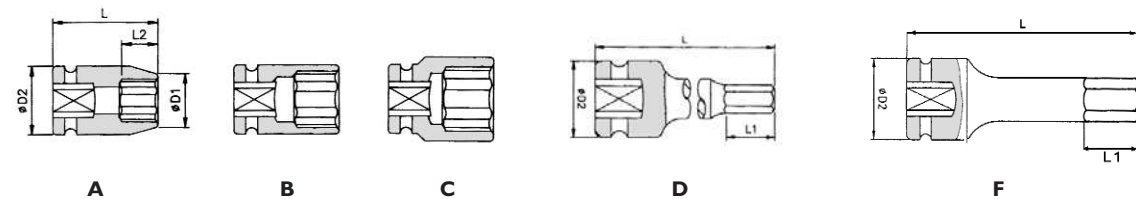

Sleeve drive sockets & Extension bars 3/8" - 3/4"



Extension bar

3/4" Sleeve drive power sockets - normal ①

Type	A/F mm	Drawing	D1 mm	D2 mm	L mm	L2 mm
<i>Metrical</i>						
DO60940017	17	A	31	44	65	12
DO60940018	18	A	32	44	65	12
DO60940019	19	A	33	44	65	14
DO60940021	21	A	35	44	65	16
DO60940022	22	A	37	44	65	16
DO60940023	23	A	38	44	65	16
DO60940024	24	A	39	44	65	16
DO60940026	26	A	41	44	65	16
DO60940027	27	A	43	44	65	16
DO60940028	28	B	44	44	68	20
DO60940029	29	C	45	44	68	20
DO60940030	30	C	47	44	68	20
DO60940032	32	C	49	44	70	20
DO60940033	33	C	51	44	70	20
DO60940034	34	C	52	44	70	20
DO60940035	35	C	53	44	70	20
DO60940036	36	C	54	44	70	20
DO60940038	38	C	57	44	72	22
DO60940041	41	C	60	44	72	22
DO60940046	46	C	67	54	77	23
DO60940050	50	C	71	54	77	23

3/4" Sleeve drive power sockets for hex head ②

Type	A/F mm	Drawing	D1 mm	D2 mm	L mm	L1 mm
<i>Metrical</i>						
DO68945010	10	F	-	44	100	20
DO68945012	12	F	-	44	100	20
DO68945014	14	F	-	44	100	20
DO68945016	16	F	-	44	100	20
DO68945017	17	F	-	44	100	20
DO68945019	19	F	-	44	100	20
DO68945022	22	F	-	44	100	20
DO68945024	24	F	-	44	100	20
DO68945027	27	F	-	44	100	20
DO68945030	30	F	-	44	100	20
DO68945032	32	F	-	44	100	20
DO68945033	33	F	-	44	100	20
DO68945036	36	F	-	44	100	20
DO68945038	38	F	-	44	100	20

3/4" Sleeve drive power sockets Torx® external ③

Type	A/F mm	Drawing	D1 mm	D2 mm	L mm	L2 mm
<i>Metrical</i>						
DO66940018	E18	A	26	44	65	12.5
DO66940020	E20	A	28	44	65	14
DO66940022	E22	A	31	44	65	15
DO66940024	E24	A	33	44	65	16.5

Torx® is a trademark of Textron.

Extension bars for sleeve drive power sockets ④

Type	Square-drive	Drawing	Length mm	D2 mm
DO64614075	3/8"	D	75	22
DO64614125	3/8"	D	125	22
DO64614250	3/8"	D	250	22
DO64624075	1/2"	D	75	25
DO64624125	1/2"	D	125	25
DO64624175	1/2"	D	175	25
DO64624250	1/2"	D	250	25
DO64644175	3/4"	D	175	44
DO64644250	3/4"	D	250	44
DO64644330	3/4"	D	330	44

Pins and rings ⑤

Type	Square-drive
DO1014-0-000	1/4"
DO1038-0-000	3/8"
DO1012-0-000	1/2"
DO1034-0-000	3/4"
DO1100-0-000	1"
DO1112-0-000	1 1/2"
DO2112-0-000	2 1/2"



①



②



③



④



⑤

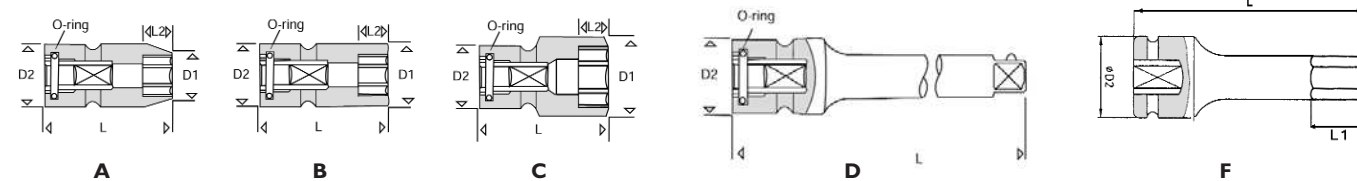

Impact sockets

Sets

3/8" Impact socket set Type DO0038-0-010

Contents
10 Impact sockets, normal sizes
9 - 10 - 11 - 12 - 13 - 14 - 15 - 16 - 17 - 19 mm
Package: plastic tray & metal case



1/2" Impact socket set Type DO0012-0-000S

Contents
10 Impact sockets, normal sizes
9 - 10 - 11 - 13 - 14 - 17 - 19 - 22 - 24 - 27 mm
Package: metal case



3/4" Impact socket set Type DO0034-0-008

Contents
8 Impact sockets, normal sizes
24 - 27 - 30 - 32 - 33 - 36 - 38 - 41 mm
Package: plastic tray & metal case



1/2" External & internal Torx® impact socket set, Type DO69623161

Contents
9 Impact sockets thin wall Torx® external
E10 - E11 - E12 - E14 - E16 - E18 - E20 - E22 - E24
7 Impact sockets Torx® internal, length 55 mm
T40 - T45 - T47 - T50 - T55 - T60 - T70
Package: blow-mold case



1/2" Hex head in set Type DO69521093

Contents
9 Hex head power sockets
4 - 5 - 6 - 8 - 10 - 12 - 14 - 17 - 19 mm
Package: plastic tray & metal case



1" Impact socket set, long Type DO0100-1-007

Contents
7 Impact sockets, long size
24 - 27 - 30 - 32 - 33 - 36 - 41 mm
Package: blow-mold case

1" Impact socket set, long Type DO69551041

Contents
4 Impact sockets, long size
27 - 30 - 32 - 33 mm
Package: plastic tray & metal case



Impact sockets

Sets



1/2" Special socket set for wheel nut lock
Type DO0012-0-286

Contents

7 Impact sockets, normal sizes

17 - 18.5 - 20 - 21.5 - 23 - 24.5 - 26 mm

Package: blow-mold case



1/2" Special socket set for wheel nut lock
Type DO0012-1-286

Contents

8 Impact sockets thin wall, long sizes

17 - 18.5 - 20 - 21.5 - 23 - 24.5 - 26 - 27.5 mm

Package: blow-mold case

Application wheel lug nut remover sockets

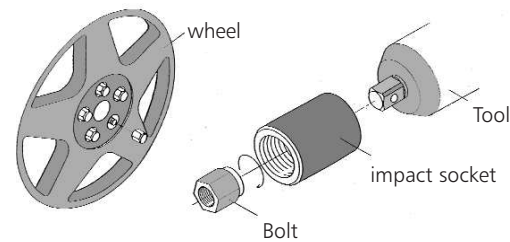

1/2" Wheel nut impact socket set
Type DO69523181

Contents

9 Impact sockets, normal sizes

10 - 11 - 13 - 14 - 17 - 19 - 21 - 22 - 24 mm

4 Impact sockets, long sizes

13 - 14 - 21 - 24 mm

3 Impact sockets thin wall, long sizes

17 - 19 - 21 mm

1 Universal joint

1 Extension bar 125 mm

Package: blow-mold case



15 Piece truckrepair set
Type DO69643151

Contents

5 Impact sockets Torx® internal T60, T70, T80, T90, T100 ¹⁾

4 Impact sockets Torx® external E18, E20, E22, E24 ²⁾

4 Impact sockets internal hex 17 - 19 - 22 - 24 mm ³⁾

+ 3/4" and 1" hexagon bitholder 22mm ⁴⁾

+ Hexagon spanner 2.5mm

Package: blow-mold case

Type	Ordernumber
¹⁾ Torx® internal T60	DO697LB060
Torx® internal T70	DO697LB070
Torx® internal T80	DO697LB080
Torx® internal T90	DO697LB090
Torx® internal T100	DO697LB100
²⁾ Torx® external E18	DO697RB118
Torx® external E20	DO697RB120
Torx® external E22	DO697RB122
Torx® external E24	DO697RB124
³⁾ Internal hex 17 mm	DO697RB017
Internal hex 19 mm	DO697RB019
Internal hex 22 mm	DO697RB022
Internal hex 24 mm	DO697RB024
⁴⁾ 3/4" hex bitholder 22mm	DO6054H022
1" hex bitholder 22mm	DO6055N022

Torque sockets

1/2" - 1"

1/2" Torque sockets

Type	A/F mm	Nm	Length	Color
DO68122D17	17	75	220	Green
DO68122L17	17	110	220	Red
DO68122G19	19	90	220	Yellow
DO68122L19	19	110	220	Blue
DO68122M19	19	135	220	Grey
DO68122E21	21	80	220	Black
DO68122L21	21	110	220	Brown



1/2" Torque-limited impact socket set Type RR-100/SET

Type	Square-drive	A/F mm	Loosening Nm	Tight max. Nm	Length mm	Outside Ø mm	Weight gr
RR-100/17	1/2"	17	Full force	100	100	26	400
RR-100/19	1/2"	19	Full force	100	100	29	400
RR-100/21	1/2"	21	Full force	100	100	30	400



1/2" Wheel nut impact socket set, long, extra long
Type DO61120310

Contents

3 Impact sockets with plastic stop and sleeve

Blue 17 mm - yellow 19 mm - red 21 mm

Package: blow-mold case

1/2" Wheel nut impact sockets with plastic stop and sleeve

Type	A/F mm	Colour	D1 mm	D2 mm	L mm	L1 mm	L2 mm
------	--------	--------	-------	-------	------	-------	-------

Metrical

DO61126015	15	White	25	30	85	60	13
DO61126017	17	Blue	27	30	85	60	14
DO61126019	19	Yellow	29	30	85	60	15
DO61126021	21	Red	31	30	85	60	17
DO61126022	22	Green	32.5	30	85	60	18

For optimal protection of aluminium rims, sockets with plastic stop and sleeve in five different bright colours for easy identification.

1" Torque sockets

Type	A/F mm	Nm	Length
DO68552U23	23	250	305
DO68552W24	24	350	305
DO68552W27	27	350	305
DO68552Z27	27	450	305
DO68552Y29	29	400	305
DO68552B30	30	550	305
DO68552A32	32	500	305
DO68552C32	32	600	305
DO68552F32	32	700	305
DO68552A33	32	500	305
DO68552C33	32	600	305



1/2" Wheel nut impact socket set, long
Type DO69523031

Contents

3 Impact sockets with plastic stop and sleeve

Blue 17 mm - yellow 19 mm - red 21 mm

Package: blow-mold case

1/2" Wheel nut impact sockets - extra long with plastic stop and sleeve

Type	A/F mm	Colour	D1 mm	D2 mm	L mm	L1 mm	L2 mm
------	--------	--------	-------	-------	------	-------	-------

Metrical

DO6112J017	17	Blue	27	25	130	87	24
DO6112J019	19	Yellow	29	30	130	87	24
DO6112J021	21	Red	31	30	130	87	24
DO6112J022	22	Green	32.5	30	130	87	24

19. Chisels & drills



Steelquality

Our factories only use steel qualities that is supplied conforming to the prescribed analyses. The most widely used steel for chisels is C70W2, for special chisels other materials can be used. Our factories check the right dimensions and tolerances and the material is continuously checked. Only a high quality of steel can be used for high quality of end-product.

Production

Before and after the production, checks are being made. Not only the used steelquality but also the production machinery are controlled by a computer and if necessary adjusted, this is being done automatically in a lot of cases.

Forging

After the machining, the points, flats and spades are forged. Often this is an automated process, the chisels are put in place by robot-arms and the chosen shape is forged. The heavy spades are forged manually. Drills for electric and pneumatic hammers are fabricated and processed on computer supported machinery. In the finishing process, the carbide tip is soldered on the drillstem.

Hardening procedure

In automated hardening ovens, the temperature and time are controlled by a computer. Chisels and drills are placed in the ovens directly in big steel containers. All relevant information (date, temperature) are being stored in a computer, in order to follow back the complete procedure in case of a warranty claim.

Finishing

If necessary, the chisels and/or drills are grinded. For cleaning, a new procedure is used with a waterjet system with a pressure of 200 bar.

Re-forging

The chisels will become blunt during the time that you work with them. They can be re-forged, this must be done by a craftsman. For this purpose, we have a "repair"-procedure. Further information can be obtained from our sales team.

Chisels

For air hammers

Shank size Ø 10.2mm x 40mm

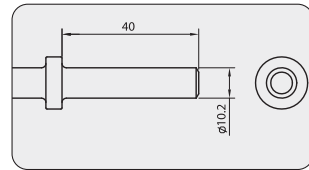

For hammers

- Yokota BRH-6
- Red Rooster RRH-4210

Ordernumber	Description	L (mm) Total	B (mm)
BE101002	Cutting chisel	122	20
BE101003	Sheet metal trimmer	135	16
BE101004	Panel cutter	131	15
BE101005	Muffler cutter	115	15
BE101006	Bushing splitter	132	12
BE101007	Spot-weld breaker bent	79	15
BE101008	Bushing driver	63	Ø 23
BE101009	Tapered punch	132	Ø 3
BE101010	Flat chisel	120	33
BE101011	Double edged cutter	110	22
BE101012	Shear bent	132	12
BE101014	Double blade panel cutter	136	18
BE101015	Wide cutting, bent	130	33
BE101016	Straight punch	120	Ø 12
BE101017	Spot-weld breaker	117	19
BE101018	Scraper	137	33
BE101019	Tail pipe cutter	119	29
BE101020	Concave scraping	130	34
BE101021	Wide cutting	129	44
BE101022	Diamond point	161	-
BE101024	Flat, bent	106	15
BE101025	Rivet cutter	109	23
BE101027	Center punch chisel	106	Ø 9
BE101028	Pin punch	134	Ø 8

Shank size 10.5mm 6KT x Ø 12.5mm x 50mm

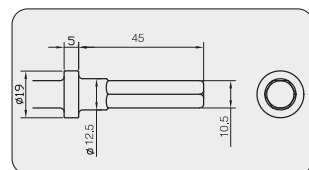

For hammers

- Red Rooster RRH-4210K,
- RRI-4021/3

Ordernumber	Description	L (mm) Total	B (mm)
BE151002	Cutting chisel	122	20
BE151003	Sheet metal trimmer	135	16
BE151004	Panel cutter	131	15
BE151005	Muffler cutter	115	15
BE151007	Spot-weld breaker bent	79	15
BE151008	Bushing driver	63	Ø 23
BE151009	Tapered punch	132	Ø 3

Continued

Shank size 10.5mm 6KT x Ø 12.5mm x 50mm

BE151010	Flat chisel	120	33
BE151011	Double edged cutter	110	22
BE151012	Shear bent	132	12
BE151014	Double blade panel cutter	136	18
BE151015	Wide cutting, bent	130	33
BE151016	Straight punch	120	Ø 12
BE151017	Spot-weld breaker	117	19
BE151018	Scraper	137	33
BE151019	Tail pipe cutter	119	29
BE151020	Concave scraping	130	34
BE151021	Wide cutting	129	44
BE151022	Diamond point	161	-
BE151024	Flat, bent	106	15
BE151025	Rivet cutter	109	23
BE151026	Round nose panel cutter	90	21
BE151027	Center punch chisel	106	Ø 9
BE151028	Pin punch	134	Ø 8
BE152001	Slotting tool with carbide tip	155	30

Shank size 13.8mm 6KT x 75mm

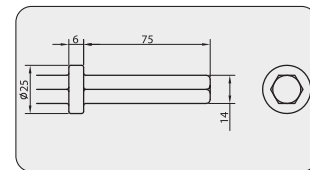

Ordernumber	Description	L (mm) under the collar	B (mm)
CB5100105/3	Moil point	200	-
CB5100102/3	Flat chisel	110	24
CB5100104/3	Flat chisel	180	24
CB5100103/3	Wide flat chisel	180	40
CB5100107/3S	Wide flat chisel	180	60
CB5100115/3	Wide flat chisel	180	100
CBMCOVAXS	Slotting tool with carbide tip	120	35
CBMCOVAXL	Slotting tool with carbide tip	140	35

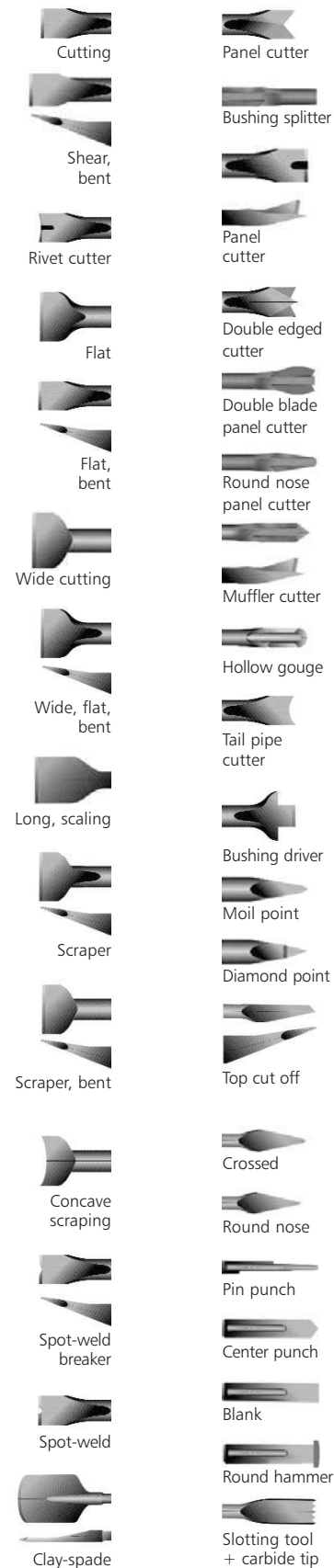

Shank size 19mm 6KT x 50mm

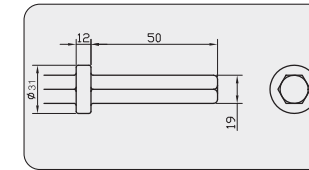

Ordernumber	Description	L (mm) under the collar	B (mm)
MP5	Moil point	250	-
MP5-350	Moil point	350	-
MP5-450	Moil point	450	-
NC5	Flat chisel	250	30
NC5-350	Flat chisel	340	30
NC5-450	Flat chisel	440	30
CB5	Wide flat chisel	250	60
CB5G	Wide flat chisel, bent	250	60
CB19210	Wide flat chisel	210	95

Shank size 22mm 6KT x 82.5mm

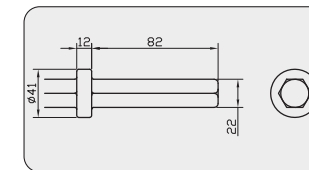

For hammers

- Toku TCD-20
- Red Rooster RRI-4596/1

Ordernumber	Description	L (mm) under the collar	B (mm)
MP4	Moil point	380	-
MP4-450	Moil point	450	-
MP4-1000	Moil point	1000	-
MP4-1500	Moil point	1500	-
MP4-2000	Moil point	2000	-
NC4	Flat chisel	380	-
NC4-450	Flat chisel	450	-
NC4-1000	Flat chisel	1000	-
NC4-1500	Flat chisel	1500	-
NC4-2000	Flat chisel	2000	-
CB4	Wide flat chisel	380	75
DC4	Digging chisel	400	75
AC4	Asphalt cutter	400	125

Shank size 25mm 6KT x 108mm

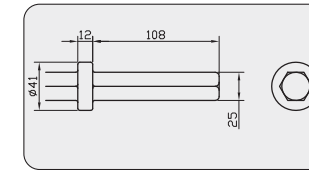

For hammers

- Toku TPB-30/40/40SV

Ordernumber	Description	L (mm) under the collar	B (mm)
MP3	Moil point	380	-
MP3-450	Moil point	450	-
MP3-1000	Moil point	1000	-
MP3-1500	Moil point	1500	-
MP3-2000	Moil point	2000	-
NC3	Flat chisel	380	25
NC3-450	Flat chisel	450	25
NC3-1000	Flat chisel	1000	25
NC3-1500	Flat chisel	1500	25
NC3-2000	Flat chisel	2000	25
CB3	Wide flat chisel	360	75
DC3	Digging chisel	400	75
AC3	Asphalt cutter	400	125

Shank size 28mm 6KT x 160mm

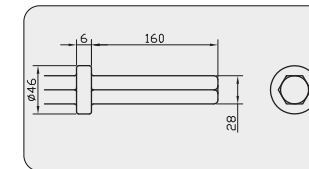

Ordernumber	Description	L (mm) under the collar	B (mm)
MP2A	Moil point	380	-
MP2	Moil point	450	-
NC2A	Flat chisel	380	35
NC2	Flat chisel	450	35
CB2A	Wide flat chisel	380	75
DC2	Digging chisel	400	75
CB5819	Asphalt cutter	350	125
AC2	Heavy asphalt cutter	270	115

Chisels

For air hammers

Shank size 32mm 6KT x 160mm

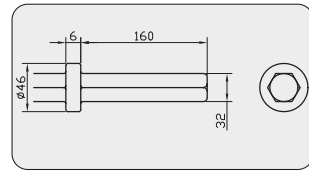

For hammers

- Toku TPB-50N, TPB-501SV, TPB-60

Ordernumber	Description	L (mm) under the collar	B (mm)
MP1A	Moil point	380	-
MP1	Moil point	450	-
MP1-600	Moil point	600	-
MP1-900	Moil point	900	-
MP1-1000	Moil point	1000	-
MP1-1500	Moil point	1500	-
MP1-2000	Moil point	2000	-
NC1A	Flat chisel	380	35
NC1	Flat chisel	450	35
CB1A	Wide flat chisel	380	75
DC1	Digging chisel	400	75
AC1	Heavy asphalt cutter	270	115
CB5019	Asphalt cutter	350	125
E1	Taper plate shank	350	-
CB203001	Sheet board driver	-	57
CB203004	Sheet board driver	-	75
CB912904*	Tamper plate	-	-
CB912906**	Tamper plate	-	-

* Diameter 125 mm

** Diameter 180 mm

Shank size Ø 25mm x 75mm collar round 42mm

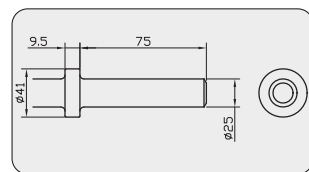

For hammers

- Red Rooster RRI-4596/R

Ordernumber	Description	L (mm) under the collar	B (mm)
B350MP	Moil point	350	-
B450MP	Moil point	450	-
B600MP	Moil point	600	-
B800MP	Moil point	800	-
B1000MP	Moil point	1000	-
B1500MP	Moil point	1500	-
B2000MP	Moil point	2000	-
B3000MP	Moil point	3000	-
B4000MP	Moil point	4000	-
B350NC	Flat chisel	350	24
B450NC	Flat chisel	450	24

Continued

Shank size Ø 25mm x 75mm collar round 42mm

B600NC	Flat chisel	600	24
B800NC	Flat chisel	800	24
B1000NC	Flat chisel	1000	24
B1250NC	Flat chisel	1250	24
B1500NC	Flat chisel	1500	24
B2000NC	Flat chisel	2000	24
B3000NC	Flat chisel	3000	24
B4000NC	Flat chisel	4000	24
B400AC	Asphalt cutter	400	125

Shank size 12.4mm 6KT / Ø 15mm x 55mm

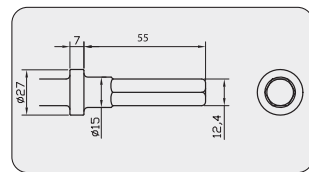

For hammers

- BMH19

Ordernumber	Description	L (mm) under the collar	B (mm)
CB1910190	Moil point	190	-
CB1910260	Moil point	260	-
CB1911190	Flat chisel	190	23
CB1911260	Flat chisel	260	23
CB1918200	Wide flat chisel	200	50
CB1917210	Wide flat chisel	210	95
CBCP4	Adaptor for bush head	200	-
CB27C*	Bush head carbide tip	-	40 x 40

* 16 teeth carbide metal

Shank size 12.7mm 6KT / Ø 15mm x 55mm

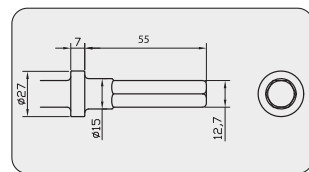

For hammers

- Toku AA-OB

Ordernumber	Description	L (mm) Total	B (mm)
BEAA-OB-01	Flat chisel	154	16
BEAA-OB-01 400mm	Flat chisel	400	16
BEAA-OB-02	Diamond point	155	-
BEAA-OB-02 400mm	Diamond point	400	-
BEAA-OB-03	Flat chisel	157	25
BEAA-OB-04	Flat chisel	157	49
BEAA-OB-05	Flat chisel	160	97
BEAA-OB-06	Flat chisel bent	148	50

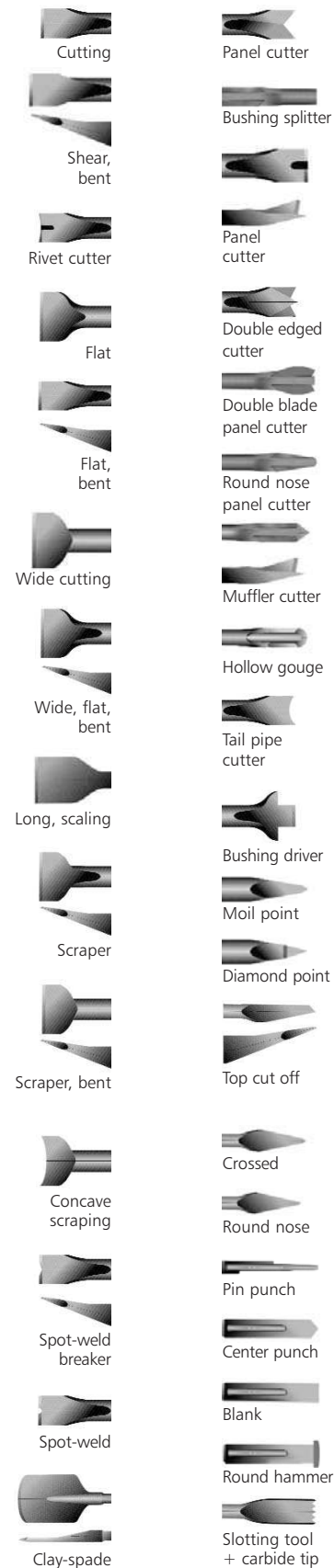

Shank size 14.8mm 6KT / Ø17.3mm x 60mm

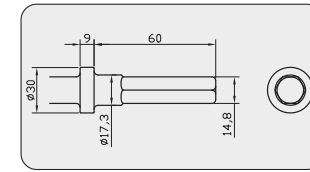

For hammers

- Toku AA-1.3B, AA-3B

Ordernumber	Description	L (mm) under the collar	B (mm)
CB3210260	Moil point	260	-
CB3210350	Moil point	350	-
CB3210450	Moil point	450	-
CB418	Round nose	210	-
CB420	Diamond point	155	-
CB414	Cape chisel	155	-
CB3211200	Flat chisel	200	20
CB3211260	Flat chisel	260	20
CB424	Flat chisel	155	50
CB426	Flat chisel	155	38
CB3218200	Wide flat chisel	200	60
CB3218200G	Wide flat chisel, bent	200	60
CB3217210	Wide flat chisel	210	95
CB3217210G	Wide flat chisel, bent	210	95
CBCP6	Adaptor for bush head	200	-
CB27C*	Bush head carbide tip	-	40 x 40

* 16 teeth carbide metal

14.8mm 6KT / Ø17.3mm x 60mm, oval collar

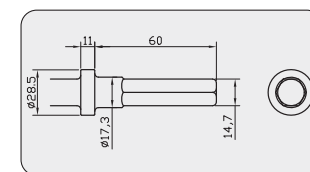

For hammers

- Toku THH-2B H, THH-3B H, THH-4B H

Ordernumber	Description	L (mm) under the collar	B (mm)
HS1-OC	Blank chisel	200	-
HS2-OC	Flat chisel	200	24
HS2-300-OC	Flat chisel	300	24
HS2-32-OC	Wide flat chisel	200	32
HS2-50-OC	Wide flat chisel	200	50
HS6-OC	Moil point	200	-

Shank size 17mm 6KT / Ø 20mm x 60mm

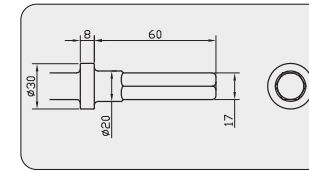

For hammers

- Böhler MH

Ordernumber	Description	L (mm) under the collar	B (mm)
CB3310220	Moil point	220	-
CB3310350	Moil point	350	-
CB3311220	Flat chisel	220	24
CB3311350	Flat chisel	350	24
CB3318200	Wide flat chisel	260	50
CB3317210	Wide flat chisel	210	95

Shank size Ø27mm x 80mm, Bund 34mm 4KT

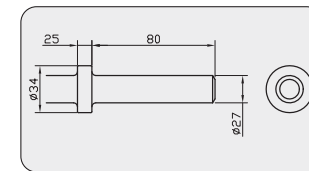

Ordernumber	Description	L (mm) under the collar	B (mm)
CB1362010045	Moil point	450	-
CB1362011045	Flat chisel	450	27
CB1362050036	Wide flat chisel	360	75
CB1362120040	Asphalt cutter	400	125
CB1362150040	Digging chisel	400	75

Shank size Ø17.3mm x 60mm, with spline profile

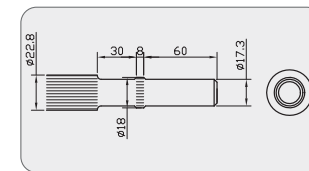

Ordernumber	Description	L (mm) Total	B (mm)
CB1321010037	Moil point	370	-
CB1321011036	Flat chisel	360	30
CB1321020034	Wide flat chisel	340	50

Chisels

For air hammers

Shank size 13mm 4KT, with recess for RRC

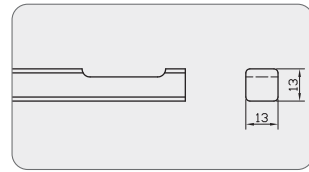

Ordernumber	Description	L (mm) Total	B (mm)
CB3251	Flat chisel	178	19
CB3251-300	Flat chisel	300	19
CB3251-450	Flat chisel	450	19
CB3252	Wide flat chisel	155	38
CB3252-300	Wide flat chisel	300	38
CB3253	Wide flat chisel, bent	178	38
CBMCOIRC13,2	Slotting tool with carbide tip	150	38

Shank size 12.3mm 4KT, with recess

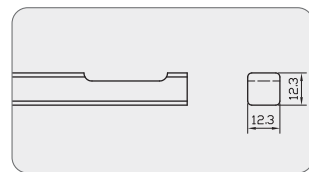

For hammers
- Yokota F25
- Red Rooster RR-0315

Ordernumber	Description	L (mm) Total	B (mm)
BE15/1B	Flat, bent	113	19
BE15/1F	Flat chisel	114	19
BE15/1G	Wide flat chisel, bent	113	35
BE15/1W	Wide flat chisel	118	35
8160-1002-00-00	Flat, bent	113	26
CBMCOF25-150	Slotting tool with carbide tip	150	35

Shank size 12.7mm 4KT, with recess

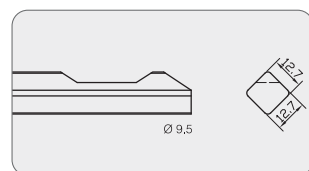

For hammers
- Toku TFC-200F

Ordernumber	Description	L (mm) Total	B (mm)
BE14/1A	Moil point	180	-
BE14/1F	Flat chisel	180	19
BE14/1G	Wide flat chisel, bent	180	35
BE14/1H	Wide flat chisel, bent	180	50
BE14/1W	Flat chisel	180	35

Shank size 12.7mm 4KT, with recess

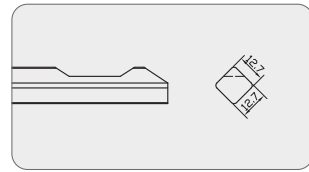

For hammers
- Ingersoll
- Toku TFC-257L

Ordernumber	Description	L (mm) Total	B (mm)
CB382	Flat chisel	178	19
CB-382-12	Flat chisel	300	19
CB-382-18	Flat chisel	450	19
CB383	Wide flat chisel	178	35
CB383-12	Wide flat chisel	300	35
CB384	Wide flat chisel	178	35
CB380	Wide flat chisel	178	50
CB380-3	Wide flat chisel	200	75
CBMCOIR	Slotting tool with carbide tip	200	38

Shank size 12.7mm 4KT, with recess

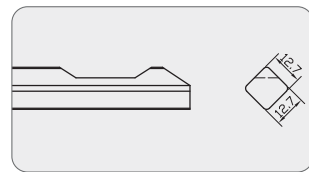

For hammers
- Thor

Ordernumber	Description	L (mm) Total	B (mm)
CB396	Flat chisel	178	19
CB396-300	Flat chisel	300	19
CB396-450	Flat chisel	450	19
CB397	Wide flat chisel	178	35
CB397-300	Wide flat chisel	300	35
CB397-450	Wide flat chisel	450	35
CB399	Wide flat chisel	178	50
CB399-75	Wide flat chisel	178	75
CB398	Wide flat chisel, bent	178	35
CB398-300	Wide flat chisel, bent	300	35
CB398-450	Wide flat chisel, bent	450	35

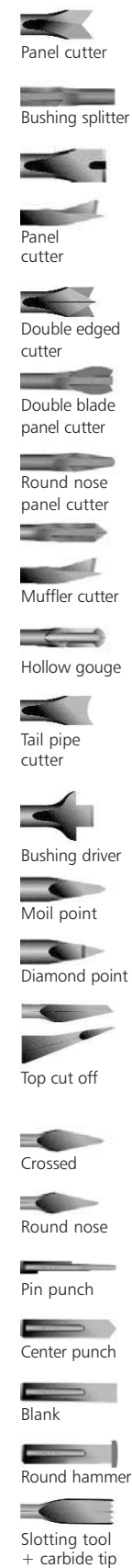

Shank size 12.7mm 4KT, with recess

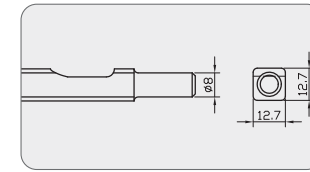

For hammers
- Cleco

Ordernumber	Description	L (mm) Total	B (mm)
CB392	Flat chisel	178	19
CB392-12	Flat chisel	300	19
CB392-18	Flat chisel	450	19
CB393	Wide flat chisel	178	35
CB393-12	Wide flat chisel	300	35
CB393-18	Wide flat chisel	450	35
CB390	Wide flat chisel	178	50
CB390-3	Wide flat chisel	178	75
CB394	Wide flat chisel, bent	178	35
CB394-12	Wide flat chisel, bent	300	35
CB394-18	Wide flat chisel, bent	450	35

Shank size Jumbo 4KT

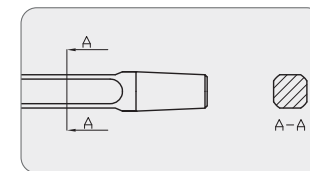

For hammers
- IR9001 (e.g.)

Ordernumber	Description	L (mm) Total	B (mm)
CB296	Moil point	250	-
CB297	Moil point	300	-
CB297-18	Moil point	450	-
CB297-24	Moil point	600	-
CB276	Flat chisel	250	24
CB276-12	Flat chisel	300	24
CB276-18	Flat chisel	450	24
CB276-24	Flat chisel	600	24
CB276-12-2	Wide flat chisel	300	50
CB278 ⁽¹⁾	Punch	250	-
CB279 ⁽²⁾	Punch	250	-
CB280 ⁽³⁾	Punch	250	-
CB281 ⁽⁴⁾	Punch	250	-
CB282 ⁽⁵⁾	Punch	250	-
CB283 ⁽⁶⁾	Punch	250	-
CB284 ⁽⁷⁾	Punch	250	-

⁽¹⁾ Diameter 10 mm ⁽⁵⁾ Diameter 22 mm
⁽²⁾ Diameter 13 mm ⁽⁶⁾ Diameter 25 mm
⁽³⁾ Diameter 16 mm ⁽⁷⁾ Diameter 28 mm
⁽⁴⁾ Diameter 19 mm

Chisels

For electrical hammers

Continued

Shank size Ø 19mm x 61mm

CB12251023025	Adaptor for bush head	250	-
CB27C ⁽³⁾	Bush head carbide tip	-	40 x 40

⁽¹⁾ Fixed model

⁽²⁾ Free rotating model

⁽³⁾ 16 teeth carbide metal

Shank size Ø 12mm x 40mm

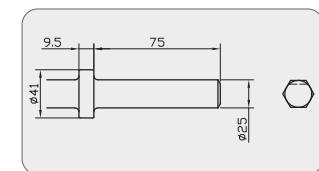

For hammers

- Makita HK1800

Ordernumber	Description	L (mm) Total	B (mm)
CB3166010018	Moil point	180	-
CB3166026015	Flat chisel	180	20
CB3166020015	Wide flat chisel	150	50

Shank size Ø 12.9mm x 77mm

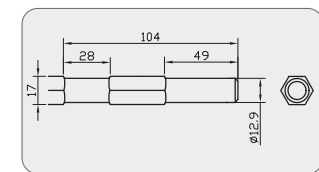

For hammers

- Makita 0810, 8035

Ordernumber	Description	L (mm) Total	B (mm)
CB2451	Moil point	280	-
CB2452	Moil point	450	-
CB2453	Flat chisel	280	20
CB2454	Flat chisel	450	20
CB2455	Wide flat chisel	280	40
CBMCOMAK0810	Slotting tool with carbide tip	280	38

Shank size Ø 16mm x 47mm

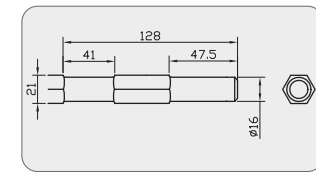

For hammers

- Makita Hm1200

Ordernumber	Description	L (mm) Total	B (mm)
CB2481	Moil point	320	-
CB2482	Moil point	450	-
CB2483	Flat chisel	320	20
CB2484	Flat chisel	450	20
CB2485	Wide flat chisel	320	50
CB2485-70	Wide flat chisel	320	70

Shank size Ø 24mm x 55mm

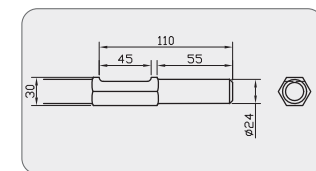

For hammers

- Makita
- Hitachi

Ordernumber	Description	L (mm) Total	B (mm)
CB3021	Moil point	400	-
CB3022A *	Flat chisel	400	32
CB3022B *	Flat chisel	400	32
CB3023A *	Wide flat chisel	400	75
CB3023B *	Wide flat chisel	400	75
CB3024A *	Asphalt cutter	400	125
CB3024B *	Asphalt cutter	400	125

* Type A: recess parallel on flat side of the spade, type B: crosswise.

Shank size Ø 12.9mm x 77mm

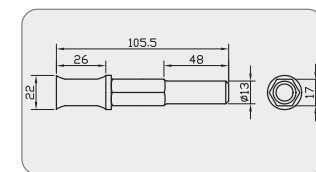

For hammers

- Hitachi Dh38YB

Ordernumber	Description	L (mm) Total	B (mm)
CB2571	Moil point	280	-
CB2572	Moil point	450	-
CB2573	Flat chisel	280	20
CB2574	Flat chisel	450	20
CB2575	Wide flat chisel	280	50
CB2576	Wide flat chisel	450	50



Cutting



Shear, bent

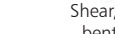

Rivet cutter



Flat



Flat, bent



Wide cutting



Wide, flat, bent



Long, scaling



Scraper



Scraper, bent



Concave scraping

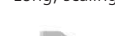

Spot-weld breaker



Spot-weld



Clay-spade



Panel cutter



Bushing splitter



Panel cutter

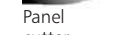

Double edged cutter



Double blade panel cutter



Round nose panel cutter



Muffler cutter



Hollow gouge

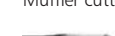

Tail pipe cutter



Bushing driver

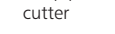

Moil point



Diamond point

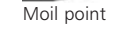

Top cut off

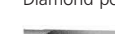

Crossed



Round nose



Pin punch

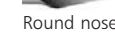

Center punch

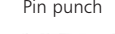

Blank



Round hammer



Slotting tool + carbide tip

Shank size Ø 17mm x 39mm

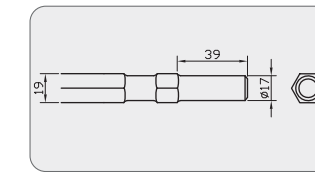

For hammers

- Hilti TP400

Ordernumber	Description	L (mm) Total	B (mm)
CB2710	Moil point	360	-
CB2711	Moil point	500	-
CB2712	Flat chisel	360	23
CB2713	Flat chisel	500	23

Shank size for Hilti TE805 and TE905

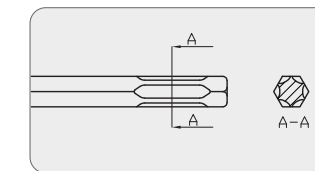

For hammers

- Hilti TE805, TE905

Ordernumber	Description	L (mm) Total	B (mm)
CB914972	Moil point	360	-
CB914974	Moil point	500	-
CB914982	Flat chisel	360	29
CB914984	Flat chisel	500	29
CB914992	Wide flat chisel	360	50
CB914994	Wide flat chisel	500	50
CB914995	Wide flat chisel	360	75
CB914996	Wide flat chisel	500	75
CB914997	Digging chisel	500	75
CB914999	Digging chisel	500	120

Shank size Ø 20mm x 48.5 mm

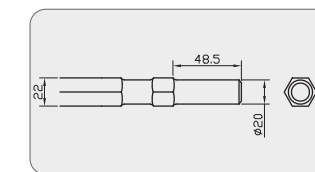

For hammers

- Hilti TP800

Ordernumber	Description	L (mm) Total	B (mm)
CB2760	Moil point	360	-
CB2761	Moil point	500	-
CB2762	Flat chisel	360	25
CB2763	Flat chisel	500	25

Shank size 19mm 6KT x 82.5mm

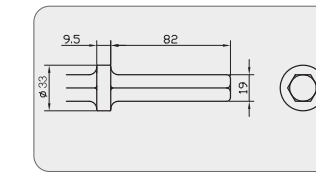

For hammers

- Wacker

Ordernumber	Description	L (mm) Total	B (mm)
CB2901	Moil point	330	-
CB2902	Moil point	400	-
CB2903	Moil point	500	-
CB2904	Flat chisel	330	24
CB2906	Flat chisel	500	24
CB2907	Wide flat chisel	330	65

Shank size 13mm 6KT x 67mm

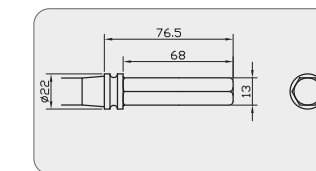

For hammers

- Duss P28

Ordernumber	Description	L (mm) Total	B (mm)
CB2271	Moil point	340	-
CB2272	Flat chisel	340	20
CB2273	Wide flat chisel	340	40

Shank size 16mm 6KT x 100mm

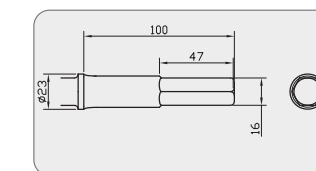

For hammers

- Duss PK35, PK40, PK45, PK75

Ordernumber	Description	L (mm) Total	B (mm)
CB2291	Moil point	400	-
CB2293	Flat chisel	400	24
CB2295	Wide flat chisel	360	50

Chisels

For electrical hammers

Shank size 22mm 6KT

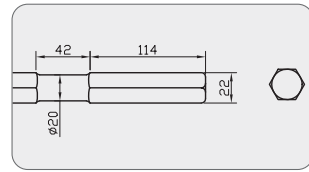

For hammers
- Duss PK150

Ordernumber	Description	L (mm) Total	B (mm)
CB15101000050	Moil point	500	-
CB15102030050	Flat chisel	500	30
CB914659	Wide flat chisel	500	50
CB914669	Wide flat chisel	500	75

Shank size 22mm 6KT with recesses

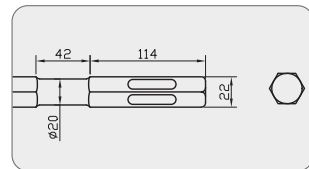

For hammers
- Duss PK160, PK300

Ordernumber	Description	L (mm) Total	B (mm)
CB100526	Moil point	400	-
CB100533	Moil point	500	-
CB100527	Moil point	600	-
CB100528	Moil point	650	-
CB100529	Flat chisel	400	28
CB100534	Flat chisel	500	28
CB100530	Flat chisel	600	28
CB100531	Flat chisel	650	28
CB100535	Wide flat chisel	500	50
CB100532	Wide flat chisel	600	50

Shank size

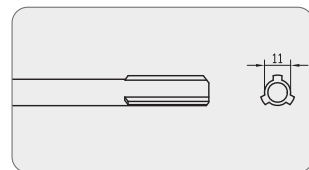

For hammers
- Impex EH25

Ordernumber	Description	L (mm) Total	B (mm)
CBEH25MP	Moil point	250	-
CBEH25NC	Flat chisel	250	20
CBEH25WF	Wide flat chisel	250	40
CBMCOEH25	Slotting tool with carbide tip	250	35

Drills

For electrical hammers

Drills SDSplus S4

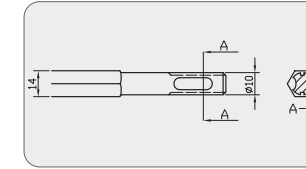

Ordernumber	L (mm) Total	Ø (mm)
4C411	110	4
4C416	160	4
4C511	110	5
4C516	160	5
4C521	210	5
4C530	300	5
4C5511	110	5.5
4C611	110	6
4C616	160	6
4C621	210	6
4C626	260	6
4C6511	110	6.5
4C6516	160	6.5
4C711	110	7
4C716	160	7
4C811	110	8
4C816	160	8
4C821	210	8
4C826	260	8
4C830	300	8
4C840	400	8
4C846	460	8
4C861	610	8
4C916	160	9
4C921	210	9
4C1011	110	10
4C1016	160	10
4C1021	210	10
4C1026	260	10
4C1030	300	10
4C1035	350	10
4C1045	450	10
4C1060	600	10
4C10100	1000	10
4C1116	160	11
4C1126	260	11
4C1216	160	12
4C1221	210	12
4C1226	260	12
4C1230	300	12
4C1245	450	12
4C1260	600	12
4C12100	1000	12
4C1316	160	13
4C1321	210	13

4C1326	260	13
4C1330	300	13
4C1345	450	13
4C1416	160	14
4C1421	210	14
4C1426	260	14
4C1430	300	14
4C1445	450	14
4C1460	600	14
4C14100	1000	14
4C1516	160	15
4C1521	210	15
4C1526	260	15
4C1545	450	15
4C1616	160	16
4C1621	210	16
4C1626	260	16
4C1630	300	16
4C1645	450	16
4C1660	600	16
4C1680	800	16
4C16100	1000	16
4C1721	210	17
4C1730	300	17
4C1821	210	18
4C1826	260	18
4C1830	300	18
4C1845	450	18
4C1860	600	18
4C1880	800	18
4C18100	1000	18
4C1921	210	19
4C1945	450	19
4C2021	210	20
4C2030	300	20
4C2045	450	20
4C2060	600	20
4C2080	800	20
4C20100	1000	20
4C2226	260	22
4C2230	300	22
4C2245	450	22
4C2260	600	22
4C22100	1000	22
4C2426	260	24
4C2440	400	24
4C2445	450	24
4C2526	260	25
4C2530	300	25
4C2545	450	25
4C2560	600	25
4C25100	1000	25
4C2626	260	26
4C2645	450	26

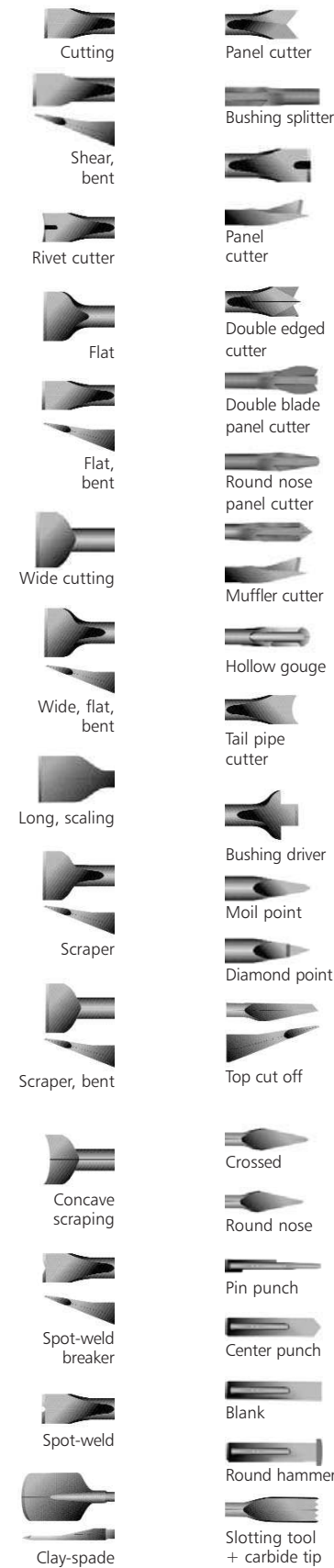

Drills

For electrical hammers

Drills SDSmax

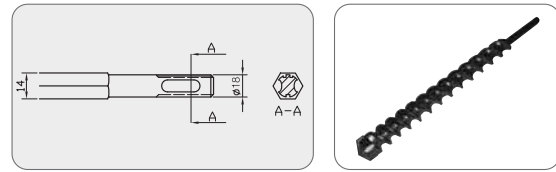

Ordernumber	L (mm) Total	Ø (mm)
CB04051	340	12
CB04052	540	12
CB04053	690	12
CB04054	340	14
CB04055	540	14
CB04056	340	15
CB04057	540	15
CB04080	340	16
CB04081	540	16
CB04082	340	18
CB04083	540	18
CB04084	320	20
CB04085	520	20
CB04086	920	20
CB04087	320	22
CB04088	520	22
CB04089	920	22
CB04090	320	24
CB04091	540	24
CB04092	320	25
CB04093	520	25
CB04094	920	25
CB04095	520	26
CB04096	370	28
CB04097	580	28
CB04098	670	28
CB04099	370	30
CB04100	570	30
CB04101	370	32
CB04102	570	32
CB04103	920	32
CB04104	370	35
CB04105	570	35
CB04106	670	35
CB04107	370	38
CB04108	570	38
CB04109	370	40
CB04110	570	40
CB04111	920	40
CB2484045057	570	45
CB2484052057	570	52

For air hammers

Monobloc-drills shank 14.8mm 6KT x 89mm combi For hammers - Toku TH-5S

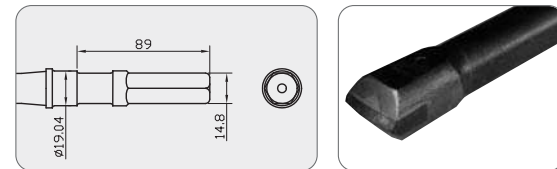

Ordernumber	L (mm) Total	Ø (mm)
CB9F33013	330	13
CB9F43013	430	13
CB9F33016	330	16
CB9F43016	430	16
CB9F33019	330	19
CB9F43019	430	19
CB9F33022	330	22
CB9F43022	430	22

Monobloc-drills shank 22mm 6KT x 108mm For hammers - Toku TJ-15LBS

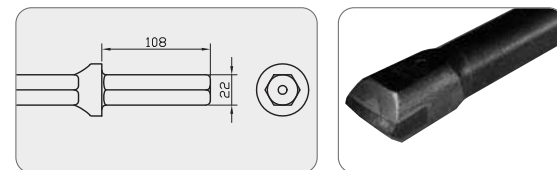

Ordernumber	L (mm) Total	Ø (mm)
CB2240016	400	16
CB2260016	600	16
CB2240019	400	19
CB2260019	600	19
CB22100019	1000	19
CB2230022	300	22
CB2240022	400	22
CB2260022	600	22
CB22100022	1000	22
CB2240025	400	25
CB2260025	600	25
CB22100025	1000	25
CB2250027	500	27
CB2260028	600	28
CB2260030	600	30

For air hammers

Monobloc-drills shank 19mm 6KT x 50mm

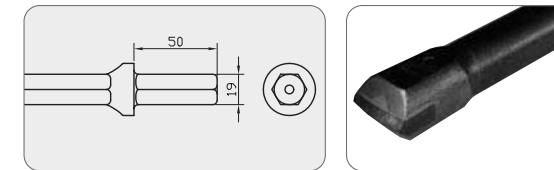

Ordernumber	L (mm) Total	Ø (mm)
CB19525014	250	14
CB19535014	350	14
CB19550014	500	14
CB19525016	250	16
CB19535016	350	16
CB19550016	500	16
CB19525018	250	18
CB19535018	350	18
CB19540018	400	18
CB19550018	500	18
CB19535020	350	20
CB19540020	400	20
CB19540022	400	22
CB19530024	300	24

Drill bars shank 22mm 6KT x 108mm, Konus II For hammers - Toku TJ-15LBS

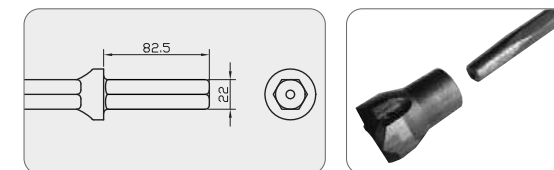

Ordernumber	L (mm) Total	Ø (mm)
CB2261510500	500	-
CB2261510800	800	-
CB2261511000	1000	-
CB2261511500	1500	-
CB2261512000	2000	-
CB2261512500	2500	-
CB2261513000	3000	-

Drill bit crossheads, Konus II

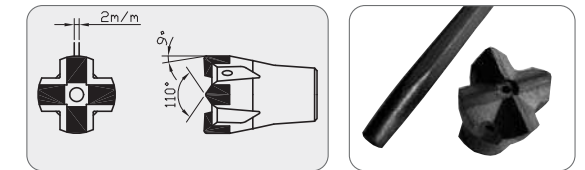

Ordernumber	L (mm) Total	Ø (mm)
CB6126300030	-	30
CB6126300032	-	32
CB6126300034	-	34
CB6126300036	-	36
CB6126300038	-	38
CB6126300040	-	40
CB6126300045	-	45
CB6126300050	-	50
CB6126300060	-	60
CB6126300070	-	70

Index

0 - 9

4C**	201
8130-1001-00-00	137
8130-1002-00-00	137
8160-1002-00-00	194
7VC-6500FS	68
7VC-8500FS	68
10RD-2005 BK	58
10RDR-1800 BK	58
13RD-755 BK	58

A

AA-0B	78
AA-1.3B	78
AA-3B	78
AC**	141
AF**	142
AFD**	143
AFM**	143
AKM**	148
AL**	146
AMG**	140
AN**	148
AR**	144
ATP**	114
ATPSR**	115
AW**	145

B

B**	192
BE**	190-194
BRH-6	78

C

CB**	190 - 203
------	-----------

D

DC**	191 - 192
DO**	154 - 187

E

e-M60	42
e-M80	42
E**	192
EAD**	148
ELB-15	135
ELB-22	135
ELB-30	135
ELB-40	135
ELB-50	135
ELB-60	135
ELB-70	135
ETL-1	135
ETL-2	135
ETL-3	135
ETP-14	134
ETP-15	134
ETP-16	134

F

F-25	78
F-25N	84
FD**	128-129

G

G-40EF/RF	67
G-40SRF	67
G-50EF/RF	67
G-70EF	67
GS-2EFS	68

H

HS**	193
HS-4	72
HS-4G	67
HTB-0	134
HTB-1	134
HTB-2	134

I

IDFA**	150
ISE35-**	148

K

K**	148
-----	-----

L

LV**	124-125
------	---------

M

MD-10L	58
MD-3312B	58
MG-0A	66
MG-0C	66
MG-1B	66
MG-7206B	66
MG-7236B	66
MI-12	24
MI-16	24
MI-17HEG	24
MI-20P	24
MI-38	25
MI-42	25
MI-1600	24
MI-2000	25
MI-2500	24-25
MI-3800	24-25
MI-4500	25
MID-600	52
MISCO10606	44
MP**	191-192
MR-2207C	48
MR-2209C	48
MR-2310B	48
MR-2410B	48
MS-230	72
MS-4125B	72

N

NC**	191-192
N032	137
NOBP	137

O

OAW-**	130-131
--------	---------

P

PT**	136
PT-1025	137
PT-1037	137

R

RR-0315	78
RR-0315NS	84
RR-15P	24
RR-20PN	24
RR-100/SET	187
RR-476	102
RR-550	53
RR-580	53
RR-2110NS	84
RR-8724	52
RR-8725	52
RRB-280	72
RRG-200RE(L)	66
RRG-202T	66
RRG-2034	67
RRG-2044	67
RRG-2055	67
RRG-2090	66
RRG-3611	73
RRG-3617K	73
RRG-3621	73
RRG-3630	73
RRH-4210 (K)	78
RRI-0251AOT/S	53
RRI-0345AOT/S	53
RRI-0529AOT/S	53
RRI-0645P	53
RRI-0830SP/SL	53
RRI-17HE	24
RRI-1025	24
RRI-1045	24
RRI-1051	25
RRI-1055	25
RRI-1060	25
RRI-1065	25
RRI-2006	58
RRI-2116P	58
RRI-21921	102

RRI-2206/28	58
RRI-2206/40	58
RRI-2580SP	53
RRI-25100P	53
RRI-3006	66
RRI-3007	66
RRI-3325 (L/EL)	66
RRI-3330	66
RRI-3335	66
RRI-3430	66
RRI-3445	66
RRI-3506	66
RRI-4006	84
RRI-4007 (VL)	84
RRI-4008	84
RRI-4010	102
RRI-4011	102
RRI-4021/3	78
RRI-4596/1	78
RRI-4596 R	78
RRI-6NV/CV/SV	72
RRI-610040 C/P	111
RRI-615060 C/P	111
RRI-620080 C/P	111
RRI-625040 C/P	111
RRI-635060 C/P	111
RRI-650080 C/P	111
RRI-675120 C/P	111
RRI-700500	122
RRI-701000	122
RRI-701500	122
RRI-702000	122
RRI-8001	88
RRI-8002	88
RRI-8003	88
RRI-8004	88
RRI-8011	88
RRI-8031	88
RRI-8032	88
RRI-8100	92
RRI-8205	92
RRI-8210	92
RRI-8460	93
RRI-8550	93
RRI-9001/1	134
RRI-9003/1	134
RRI-9005/1	134
RRI-9010	102
RRP-203	102
RRS-6001 2K	72
RRS-6001 3K	72
RRS-6004 3K	72
RRW-2202	48
RRW-2203	48

RRW-2403	48
RRW-2404	48
RRW-121	48
RSB-15	135
RSB-22	135
RSB-30	135
RSB-40	135
RSB-45	135
RSB-60	135

S

SB-**	126-127
SKK	44
SK2	44

T

TAG-40FLH	67
TAG-45MLH	67
TAG-50MLH	67
TAG-700 QJL	67
TAG-900 QJL	67
TCD-20	78
TC**	196-197
TCR-125 C/DP	108
TCR-250 C/DP	108
TCR-500 C/DP	108
TCR-500 C/P	110
TCR-500/2 C/DP	108
TCR-1000 C/P	110
TCR-1000/2 C/P	110
TCR-2000/2 C/P	110
TCR-3000 C/P	110
TCR-6000/2 C/P	110
TCR-600250 C/P	110
TCR-12000 C/P	111
TCR-15000 C/P	111
TCS-500	108
TDN-5D	98-99
TDN-6	98
TFC-200F	78
TFC-257L	78
TFC-N200	84
TH-5S	79
THH-2B H	78
THH-3B H	78
THH-4B H	78
TJ-15 LBS/SBS	79
TKa60 (A)	30/41
TKa70 (A)	30/41

