



**BRINKS**  
A TRUSTED NAME IN SECURITY SINCE 1859™

**PUSH PULL ROTATE**  
DOOR LOCKS™



**THE HANDS-FULL**  
door knob®

*The Door Lock That*

**OPENS 3 WAYS**



## TABLE OF CONTENTS

### A: Push Pull Rotate Innovative Technology

Features and Benefits	4
Specifications	5-10

### B: General Information

Order Codes and Information	11-12
General Information	14-15
ANSI Functions	16-17

### C: List Pricing

Hardware	19-26
Keys	27
Keying Charges	27
Cylinders	28
Latches	29-31
Strikes & Accessories	32
Pinning Kits	33-34

### D: Terms and Conditions

Terms and Conditions	35
----------------------	----



BRINKS and all related logos are trademarks or registered trademarks of Brinks Network, Inc., and are used with permission. Patent Notice: Hampton Products International Corporation products marketed under **Brinks**, "**PUSH PULL ROTATE**", and other brand names may be covered by both issued and pending U.S. and foreign patents, copyrights and trademarks, including one or more of the following patents: 9121200, 9212507, 9371671, D691447, D691448, D691449, D691450, D691451, D691452, D691454, D691455, D710676, D701748, D739703, D739704, D767971.



## NEW FROM BRINKS

### A New, Hip Way to Open a Door

Push Pull Rotate door locks from Brinks make opening doors easier whether your hands are full or free. A tug with a single finger, or a quick bump with an elbow or hip, can open interior or exterior doors more easily, and without setting down groceries, children, or mobile phones.

Push Pull Rotate door locks, the only locks that open 3 ways.



## NEW BUILDER UPGRADE

Stand Out! Give home buyers the convenience of opening a door 3 ways!

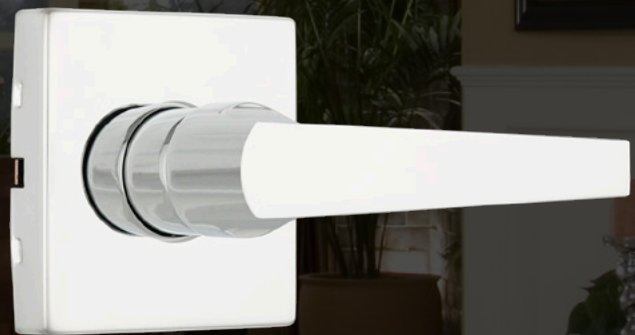

## FEATURES & BENEFITS

### Superior Craftsmanship

- Cylindrical chassis for durability
- Hidden screws for a more attractive appearance
- Larger rose diameter (almost 3") to hide the blemish from old hardware
- Removable interior knob/lever for a scratch free installation
- Lever meets ADA requirements
- Easy adjustment for door thickness

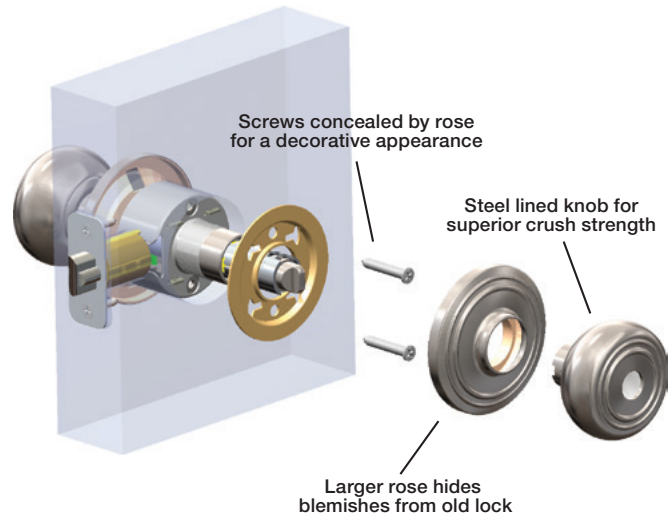

### For Any Door in Your House

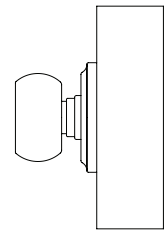
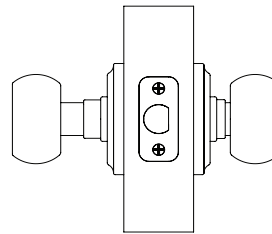
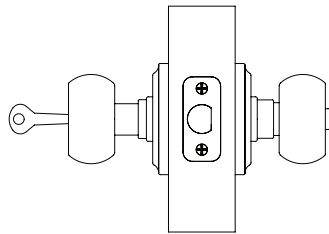
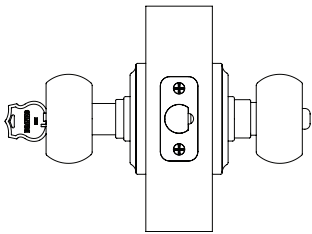

**Exterior Locking**

Keyed entry for front doors, back doors, and garage doors

**Interior Locking**

Privacy locks for bedrooms and bathrooms

**Interior Non-Locking**

Passage locks for laundry rooms, pantries, kid's rooms, and closets

**Dummy**

Dummy locks for closets and French doors



**SECURE**



**TOUGH**



**BUILT TO LAST**

# Levers

## Specifications

<b>Door Preparation:</b>	Cross bore 2 1/8", edge bore 1", 1" x 2 1/4" latch mortise
<b>Backset:</b>	2 3/8" or 2 3/4"
<b>Door Thickness:</b>	1 3/8" to 1 3/4"
<b>Cylinder:</b>	KW1 standard, SC1 available, 5 pin
<b>Chassis:</b>	Cylindrical
<b>Faceplate:</b>	2 1/4" Round corner, drive-in available
<b>Strikes:</b>	2 1/4" full rim standard for entry, 2 1/4" full lip standard for interior, others available
<b>Bolt:</b>	1/2" Throw
<b>UL:</b>	90 Minute fire rated available
<b>ADA:</b>	Levers are ADA compliant
<b>Door Handing:</b>	All hardware is reversible for left or right handed doors except the Glenshaw entry levers in contractor boxes or Glenshaw dummy levers. These need to be specified for left or right handed doors.
<b>ANSI Grading:</b>	Meets Grade 2 standards

## Functions

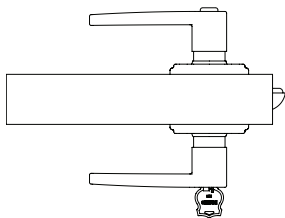

Keyed Entry

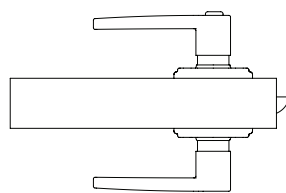

Privacy

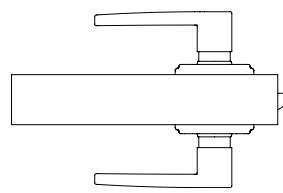

Passage

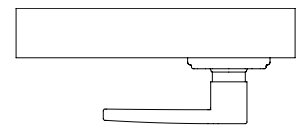

Dummy

## Finishes



Polished Chrome  
Harper



Satin Nickel  
Anna



Tuscan Bronze®  
Arnett



Polished Brass  
Glenshaw

## Dimensions

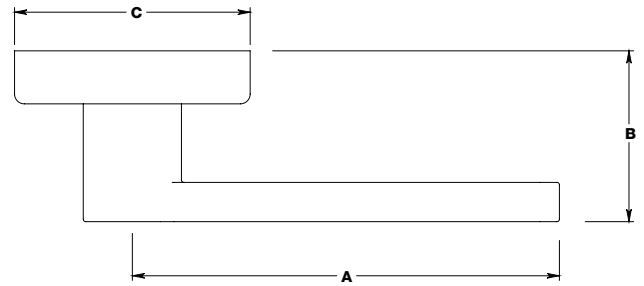

\*Dimensions shown are for outside lever, passage function, 1 3/8" thick door

Style	A(in)	B(in)	C(in)
Lexa	4.25	2.43	2.95
Anna	4.25	2.43	3.00
Harper	4.11	2.40	2.95
Alwood	4.13	2.72	2.95
Glenshaw	4.11	2.45	2.95
Arnett	4.25	2.51	2.95

Finishes	Polished Brass (105)	Satin Nickel (119)	Polished Chrome (125)	Tuscan Bronze (150)	Matte Black (122)
Lexa		•	•	•	•
Anna		•	•	•	•
Harper		•	•	•	
Alwood	•	•	•	•	
Glenshaw	•	•	•	•	
Arnett		•		•	

# Knobs

## Specifications

<b>Door Preparation:</b>	Cross bore 2 1/8", edge bore 1", 1" x 2 1/4" latch mortise
<b>Backset:</b>	2 3/8" or 2 3/4"
<b>Door Thickness:</b>	1 3/8" to 1 3/4"
<b>Cylinder:</b>	KW1 standard, SC1 available, 5 pin
<b>Chassis:</b>	Cylindrical
<b>Faceplate:</b>	2 1/4" Round corner, drive-in available
<b>Strikes:</b>	2 1/4" Full rim standard for entry, 2 1/4" full lip standard for interior, others available
<b>Bolt:</b>	1/2" Throw
<b>UL:</b>	90 Minute fire rated available
<b>Door Swing:</b>	Entry & privacy functions for in-swinging doors only
<b>ANSI Grading:</b>	Meets Grade 2 standards

Finishes	Polished Brass (105)	Satin Nickel (119)	Polished Chrome (125)	Tuscan Bronze (150)
Stafford	•	•		•
Ganyon	•	•	•	•
Lindingham		•		•
Webley	•	•		•
Barrett	•	•		

## Dimensions

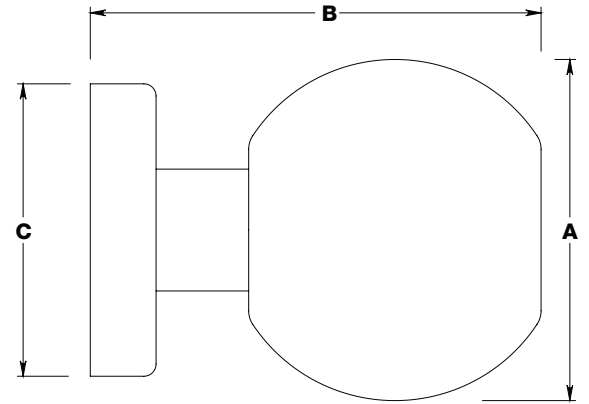

\*Dimensions shown are for outside knob, passage function, 1 3/8" thick door

Style	A(in)	B(in)	C(in)
Stafford	2.37	2.82	2.95
Ganyon	2.37	2.81	2.95
Lindingham	2.23	2.73	2.95
Webley	2.34	2.57	2.95
Barrett	2.12	2.81	2.95

## Functions

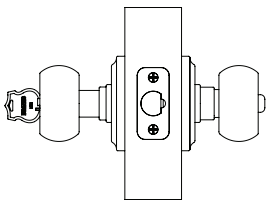

Keyed Entry

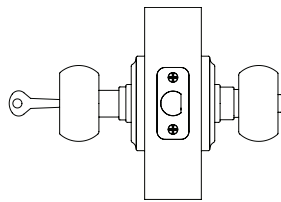

Privacy

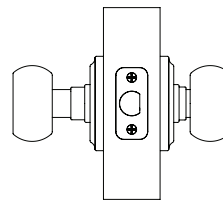

Passage

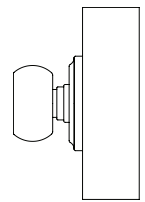

Dummy

## Finishes



Polished Chrome  
Ganyon



Satin Nickel  
Barrett



Tuscan Bronze®  
Stafford



Polished Brass  
Webley

# Transitional Deadbolts

## Specifications

<b>Door Preparation:</b>	Cross bore 2 1/8", edge bore 1", 1" x 2 1/4" latch mortise
<b>Backset:</b>	Adjustable for 2 3/8" or 2 3/4"
<b>Door Thickness:</b>	1 3/8" to 1 3/4"
<b>Cylinder:</b>	KW1 standard, SC1 available, 5 pin
<b>Faceplate:</b>	2 1/4" Round corner, drive-in available
<b>Strikes:</b>	2 3/4" Square corner
<b>Chassis Screws:</b>	Concealed
<b>Bolt:</b>	1" Throw, steel
<b>UL:</b>	90 Minute fire rated available
<b>ANSI Grading:</b>	Meets Grade 2 standards

## Dimensions

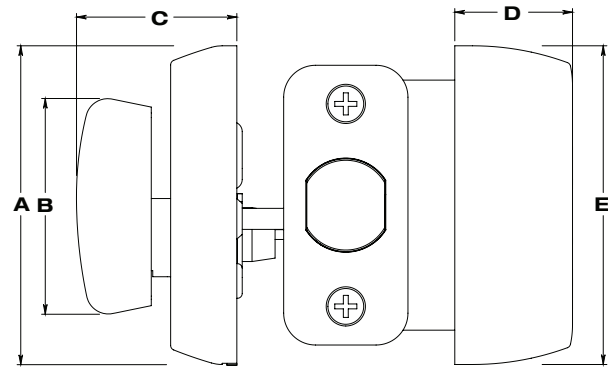

Finishes	Polished Brass (105)	Satin Nickel (119)	Polished Chrome (125)	Tuscan Bronze (150)
Almarrion	•	•	•	•
Weldon	•	•	•	•

Style	A(in)	B(in)	C(in)	D(in)	E(in)
Almarrion	2.56	1.73	1.55	.94	2.56
Weldon	2.56	1.73	1.55	.86	2.56

## Functions

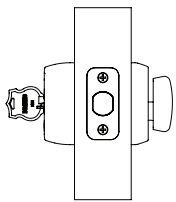

Deadbolt

## Finishes



Polished Chrome  
Weldon



Satin Nickel  
Almarrion



Tuscan Bronze®  
Alamarrion



Polished Brass  
Weldon



# Contemporary Deadbolts

## Specifications

**Door Preparation:** Cross bore 2 1/8", edge bore 1",  
1" x 2 1/4" latch mortise

**Backset:** Adjustable for 2 3/8" or 2 3/4"

**Door Thickness:** 1 3/8" to 1 3/4"

**Cylinder:** KW1 standard, SC1 available, 5 pin

**Faceplate:** 2 1/4" Round corner, drive-in available

**Strikes:** 2 3/4" Square corner

**ANSI Grading:** Meets Grade 2 standards

Finishes	Satin Nickel (119)	Polished Chrome (125)	Tuscan Bronze (150)	Matte Black (122)
Atria	•	•	•	•
Brynne		•		
Liam	•	•	•	•
Celia	•	•	•	•

## Dimensions

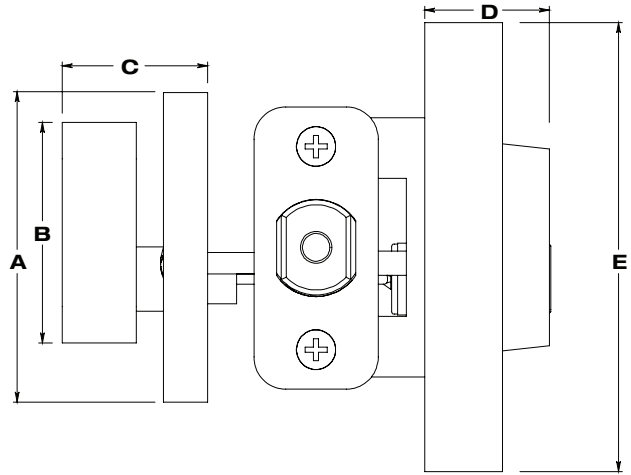

Style	A(in)	B(in)	C(in)	D(in)	E(in)
Atria	2.46	1.75	1.17	1.00	3.57
Brynne	2.46	1.75	1.17	1.00	3.57
Liam	2.66	1.97	1.48	.89	2.96
Celia	2.54	1.97	1.48	.89	2.96

## Functions

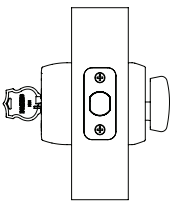

Deadbolt

## Finishes



Polished Chrome  
Brynne  
C23170-125



Satin Nickel  
Atria  
C23064-119



Tuscan Bronze®  
Liam  
C23169-150



Matte Black  
Celia  
C23170-122



# Handlesets

## Specifications

**Handle**

**Door Preparation:** Cross bore 2 1/8", edge bore 1", latch mortise 1" x 2 1/4", bottom bore hole 5/16"

**Backset:** 2 3/8" or 2 3/4"

**Door Thickness:** 1 3/8" to 1 3/4"

**Chassis:** Cylindrical, be sure to specify either lever chassis or knob chassis when ordering

**Latch:** Spring

**Bolt:** 1/2" Throw

**Faceplate:** 2 1/4" Round corner, drive-in available

**Strikes:** 2 1/4" Full lip

**Door Handing:** Reversible

**Door Swing:** In-swinging only

## Dimensions

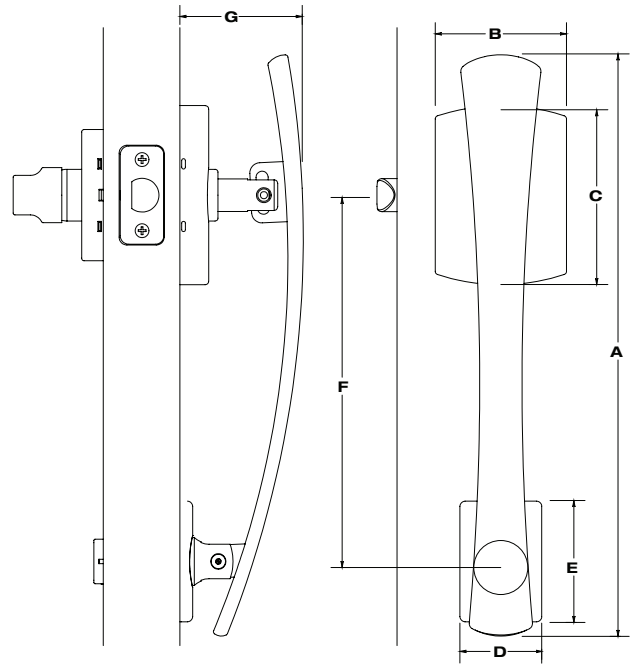

Style	A(in)	B(in)	C(in)	D(in)	E(in)	F(in)	G(in)
Anderson	13.30	3.00	4.09	1.87	2.76	8.38	2.81
Rhodes	13.20	2.95	2.95	NA	NA	8.38	2.83
Rourke	13.60	2.95	2.95	NA	NA	8.38	2.84

Finishes	Polished Brass (105)	Satin Nickel (119)	Polished Chrome (125)	Tuscan Bronze (150)
Anderson		•	•	•
Rhodes		•	•	•
Rourke	•	•		•

## Functions

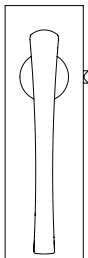

Handleset



Polished Chrome Anderson



Satin Nickel Rourke



Tuscan Bronze® Rhodes



Polished Brass Rourke

## Finishes

# Interconnected Deadbolts

## Specifications

<b>Door Preparation:</b>	2X Cross bore 2-1/8", 2X edge bore 1", 2X 1" x 2-1/4" latch mortises, backset 2-3/8" or 2-3/4"
<b>Backset:</b>	Adjustable for 2-3/8" or 2-3/4"
<b>Door Thickness:</b>	1-3/8" to 1-3/4"
<b>Cylinder:</b>	Soild brass KW1, 5 pin, SC1 available
<b>Strikes:</b>	2-3/4" x 1-1/8" square corner and 2-1/4" round corner full lip
<b>Chassis:</b>	Tubular (lever portion)
<b>Latch:</b>	1" Throw
<b>Fire Rating:</b>	3 Hour UL rated
<b>ANSI Grade:</b>	Meets Grade 2 Standards
<b>Center to Center:</b>	5-1/2"
<b>Deadbolt Keying:</b>	KD or as specified, master key, construction key available
<b>Outside Trim:</b>	Lever with return

## Dimensions

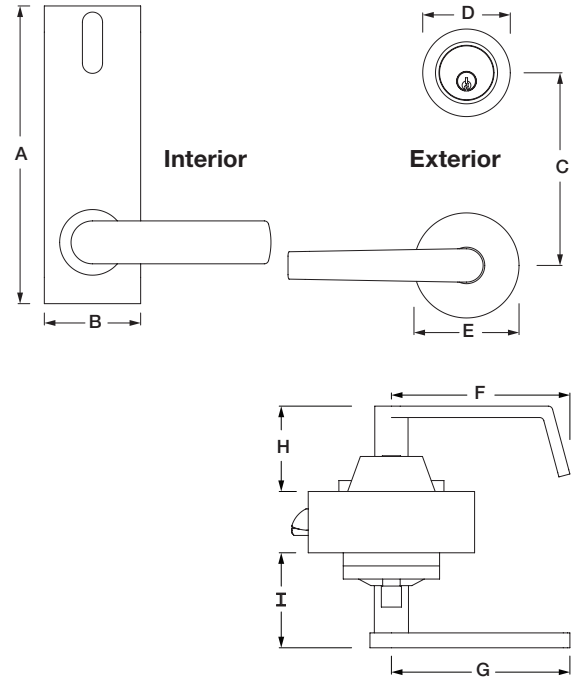

Style	A(in)	B(in)	C(in)	D(in)	E(in)	F(in)	G(in)	H(in)	I(in)
Alwood	8.58	2.75	5.50	2.56	3.00	5.00	4.10	2.50	2.95
Harper	8.58	2.75	5.50	2.56	3.00	5.00	4.21	2.50	2.70
Anna	8.58	2.75	5.50	2.56	3.00	5.00	4.25	2.50	2.64

Finishes	Satin Nickel (119)	Polished Chrome (125)	Tuscan Bronze (150)
Alwood	•		•
Harper	•		•
Anna	•	•	

## Functions

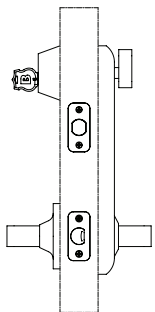

Entry Single Locking

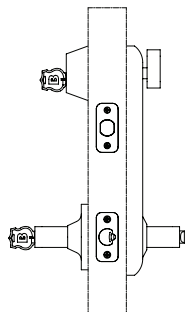

Entry Double Locking

## Finishes



Satin Nickel  
Harper

Tuscan Bronze®  
Alwood

# Stock Orders

**Item#** C 23031-119

**Specify:**

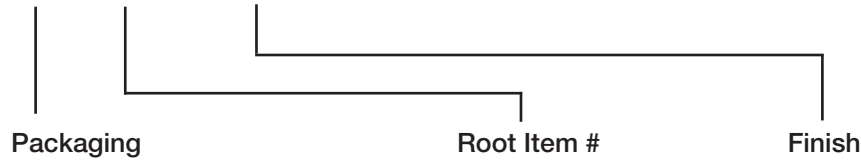

C = Contractor

Specifies Style and Function

- 105 = Polished Brass
- 119 = Satin Nickel
- 125 = Polished Chrome
- 150 = Tuscan Bronze®
- 122 = Matte Black

**Standard:**

**Case Quantity**

**Latch**

**Strike**

**Keyway**

*Contractor Packaging*

Knobs/levers/deadbolts	12
Handlesets	4
Dummy knobs	20
Dummy levers	12

Knobs = 2 3/8" and 2 3/4",  
 round corner face plate  
 Levers = 2 3/8" and 2 3/4",  
 round corner face plate  
 Handlesets = 2 3/8" and 2 3/4",  
 round corner face plate  
 Deadbolts = Adjustable 2 3/8" to 2 3/4",  
 round corner face plate

Entry = Full Rim  
 Passage/Privacy = Full Lip

KW1

# Special Ordering System

This example is for a special order for 12 Glenshaw left-hand entry levers in satin nickel with 2 3/8" drive-in latches, and SC1 keyways, T strikes, keyed differently.

**Item#** S 23014LH-119-LEDI6 - T - SC1-KD

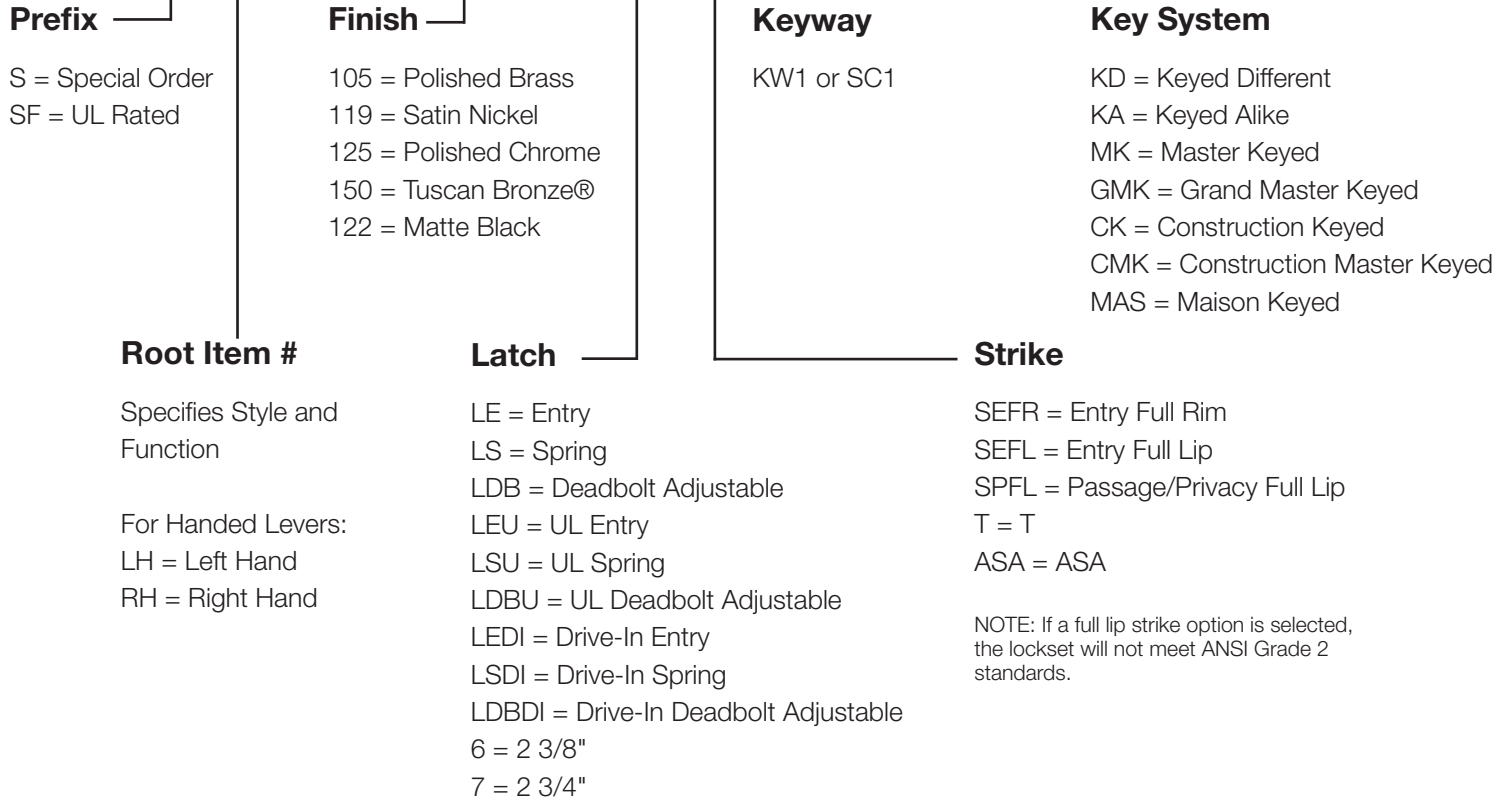



## **LOOKING FOR WAYS TO UPGRADE?**

In addition to a wide range of architectural styling, Push Pull Rotate products meet rigorous ANSI Grade 2 residential testing standards. Featuring durable, all-metal construction, Push Pull Rotate products are built on a cylindrical chassis normally used in commercial applications so they are exceptionally durable and come with a lifetime warranty. They are easily installed with a Phillips screwdriver. The keyed products are pick-resistant, bump-resistant, drill-resistant, and the deadbolts are also equipped with anti-pry shields, anti-saw pins, and steel anti-drill plates to provide the highest level of security that consumers expect from Brinks.

**LIMITED LIFETIME WARRANTY**

# General Information

## UL

### UL: Underwriters Laboratories Listed

Push Pull Rotate Locksets knobs and levers, when specified, are UL listed for 90 minute fire rating in the US and Canada when used with UL latches. Complementary deadbolts, when specified, are also UL listed for 90 minute fire rating in the US and Canada.



Note: There is a list price upcharge of \$7.00 per latch for UL 90 minute fire rated hardware.

## Door Thickness

**Door thickness adjustment is critical. The latch retractor needs to be on the centerline of the door when installed.** Keyed hardware is pre-set for thick (1 3/4") doors. Non-keyed hardware is pre-set for thin (1 3/8") doors. If an adjustment is needed, it is easy but the adjustment is different for knobs and levers. See the detailed instructions included in the package or visit [pprlocks.com](http://pprlocks.com) for installation videos.

### Knob

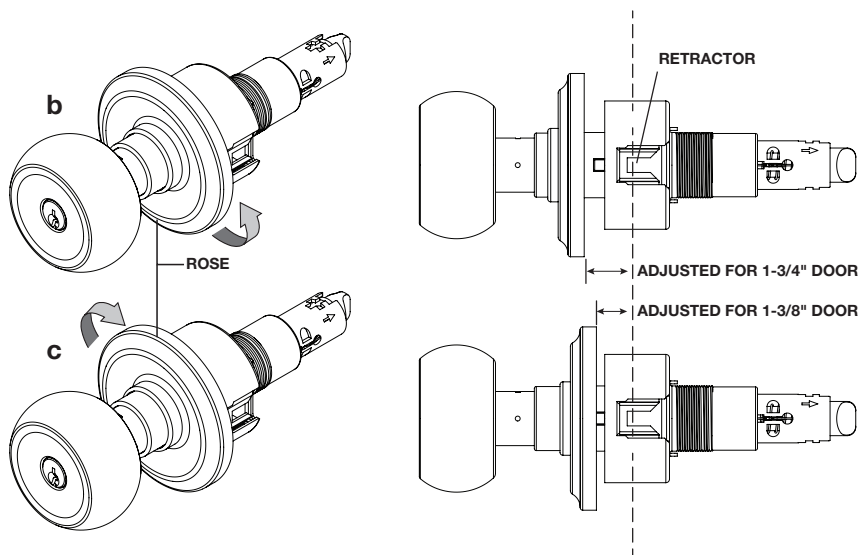

### Lever

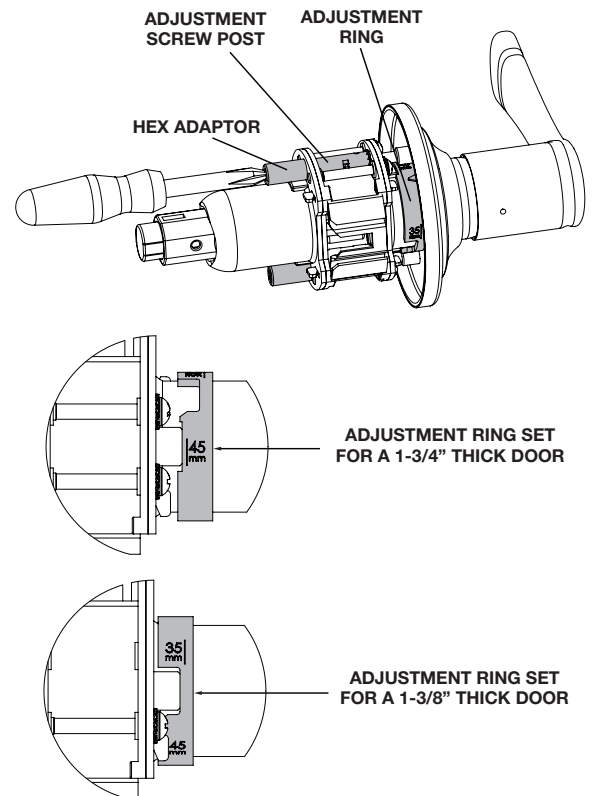

# General Information

## Door Swing

To determine the swing of a door, face the **OUTSIDE** of the door. If the door is pushed into the room to enter from the outside it is an in-swinging door. If the door is pulled open to enter the room from the outside it is an out-swinging door.

NOTE: Push Pull Rotate levers and passage knobs work on both in-swinging and out-swinging doors. Push Pull Rotate keyed and privacy knobs, and handle-sets work on in-swinging doors **ONLY**.

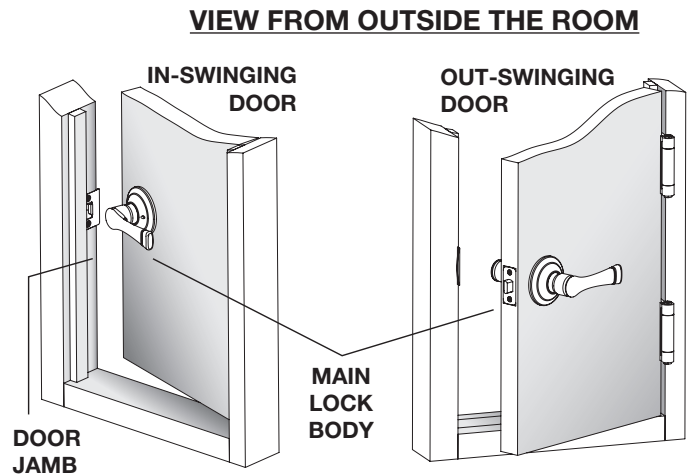

## Backset

Backset is the distance from door edge to center of the hole on the door face. Push Pull Rotate products accommodate backsets that are 2 3/8" or 2 3/4".

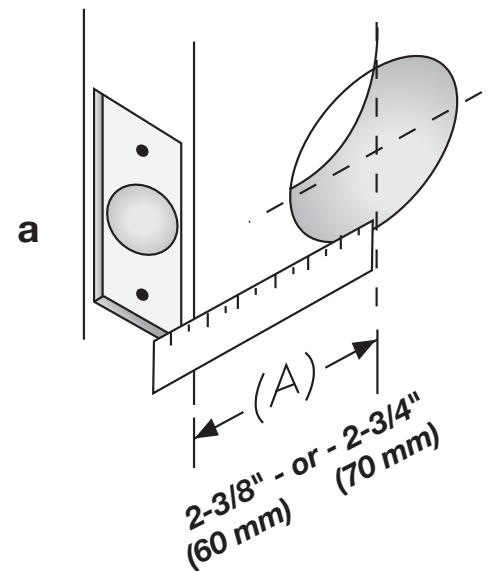

### ADA

Push Pull Rotate levers comply with the Americans with Disabilities Act of 1990.

# ANSI/BHMA FUNCTION DESIGNATIONS & DESCRIPTIONS

## PUSH PULL ROTATE KNOB

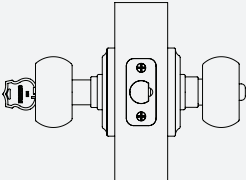
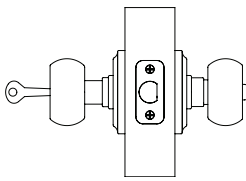
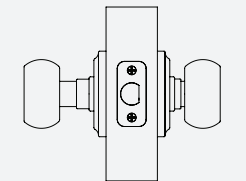
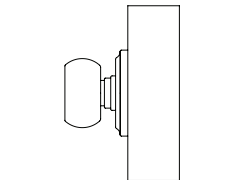
	Function	Description	BHMA Standard
	Entry	Both knobs locked or unlocked by key outside or turn button inside.  *Not fully compliant with A156.2. Inside knob does not operate the latch when locked.	F81*
	Privacy/Bed/Bath	Both knobs locked or unlocked by turn button inside. Outside knob unlocked by emergency key.  *Not fully compliant with definition of either F76A or F76B in A156.2. Inside knob does not operate the latch when locked, nor does it release the locking mechanism.	F76*
	Passage/Hall/Closet	Both knobs always free.	F75
	Dummy	For doors where only a pull is required. Does not operate a latch.	NA

## PUSH PULL ROTATE LEVER

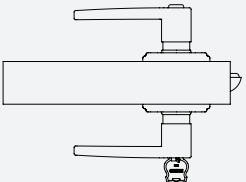
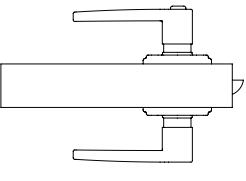
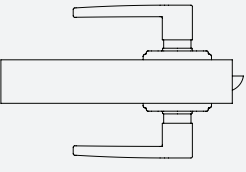
	Function	Description	BHMA Standard
	Entry	Outside lever is locked by push button inside. Outside lever is unlocked by key, or by pushing, pulling or rotating the inside lever. Inside lever is always free. Outside lever cannot be locked with key.	F82B
	Privacy Bed/Bath	Outside lever locked by push button inside. Outside lever unlocked by emergency key or by pushing, pulling or rotating inside lever, or by closing the door. Inside lever is always free.	F76A
	Passage/Hall/Closet	Both levers always free.	F75



Function	Description	BHMA Standard
Dummy	For doors where only a pull is required. Does not operate a latch.	NA

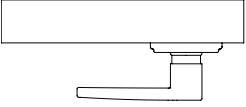

### PUSH PULL ROTATE DEADBOLT

Function	Description	BHMA Standard
Single Cylinder Deadbolt	Deadbolt operated by key outside and thumbturn inside.	E0152

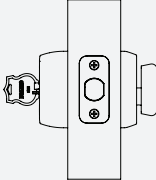

### PUSH PULL ROTATE HANDLESET

Function	Description	BHMA Standard
Passage Handleset with Single Cylinder Deadbolt	Latch bolt operated by pushing on outside handle or by pulling or turning the inside knob or lever. Handle and knob/lever are always free. Deadbolt operated by key outside and thumbturn inside.	E0152 + F75

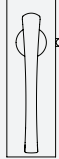



**Loaded down with laundry?...use your hip.**



**Leaving for work with your hands full?...just pull with your finger.**



**Dirty hands from working outside?...just push with your elbow.**

**...Or maybe you just want an easier way to open a door!  
Push Pull Rotate Door Locks from Brinks are the perfect solution!**

**LIST PRICING**
**KNOBS**
**Stafford**

Function	Contractor Item #	Case Pack	Polished Brass (105)	Satin Nickel (119)	Polished Chrome (125)	Tuscan Bronze (150)
Keyed Entry	C23001	12	\$49.20	\$52.10	NA	\$54.75
Privacy	C23021	12	\$32.55	\$34.45	NA	\$36.15
Passage	C23041	12	\$31.30	\$33.15	NA	\$34.80
Dummy/Inactive	C23101	20	\$13.45	\$15.30	NA	\$15.30

**Ganyon**

Function	Contractor Item #	Case Pack	Polished Brass (105)	Satin Nickel (119)	Polished Chrome (125)	Tuscan Bronze (150)
Keyed Entry	C23002	12	NA	\$52.10	\$54.75	\$54.75
Privacy	C23022	12	NA	\$34.45	\$36.15	\$36.15
Passage	C23042	12	NA	\$33.15	\$34.85	\$34.85
Dummy/Inactive	C23102	20	NA	\$15.30	\$15.30	\$15.30

**Lindingham**

Function	Contractor Item #	Case Pack	Polished Brass (105)	Satin Nickel (119)	Polished Chrome (125)	Tuscan Bronze (150)
Keyed Entry	C23003	12	NA	\$54.45	NA	\$57.10
Privacy	C23023	12	NA	\$39.60	NA	\$41.20
Passage	C23043	12	NA	\$38.25	NA	\$39.90
Dummy/Inactive	C23103	20	NA	\$18.50	NA	\$18.50

**Webley**

Function	Contractor Item #	Case Pack	Polished Brass (105)	Satin Nickel (119)	Polished Chrome (125)	Tuscan Bronze (150)
Keyed Entry	C23004	12	\$49.20	\$52.10	NA	\$54.75
Privacy	C23024	12	\$32.55	\$34.45	NA	\$36.15
Passage	C23044	12	\$31.30	\$33.15	NA	\$34.85
Dummy/Inactive	C23104	20	\$13.45	\$15.30	NA	\$15.30

**Barrett**

Function	Contractor Item #	Case Pack	Polished Brass (105)	Satin Nickel (119)	Polished Chrome (125)	Tuscan Bronze (150)
Keyed Entry	C23005	12	\$49.20	\$52.10	NA	NA
Privacy	C23025	12	\$32.55	\$34.45	NA	NA
Passage	C23045	12	\$31.30	\$33.15	NA	NA
Dummy/Inactive	C23105	20	\$13.45	\$15.30	NA	NA

## LEVERS

### Anna



Function	Contractor Item #	Case Pack	Polished Brass (105)	Satin Nickel (119)	Polished Chrome (125)	Tuscan Bronze (150)	Matte Black (122)
Keyed Entry	C23016	12	NA	\$75.35	\$75.35	\$75.35	\$75.35
Privacy	C23036	12	NA	\$61.20	\$61.20	\$61.20	\$61.20
Passage	C23056	12	NA	\$59.90	\$59.90	\$59.90	\$59.90
Dummy/Inactive	C23110	12	NA	\$29.30	\$29.30	\$29.30	\$29.30

### Lexa



Function	Contractor Item #	Case Pack	Polished Brass (105)	Satin Nickel (119)	Polished Chrome (125)	Tuscan Bronze (150)	Matte Black (122)
Keyed Entry	C23017	12	NA	\$75.35	\$75.35	\$75.35	\$75.35
Privacy	C23037	12	NA	\$61.20	\$61.20	\$61.20	\$61.20
Passage	C23057	12	NA	\$59.90	\$59.90	\$59.90	\$59.90
Dummy/Inactive	C23111	12	NA	\$29.30	\$29.30	\$29.30	\$29.30

### Harper



Function	Contractor Item #	Case Pack	Polished Brass (105)	Satin Nickel (119)	Polished Chrome (125)	Tuscan Bronze (150)	Matte Black (122)
Keyed Entry	C23012	12	NA	\$75.35	\$75.35	\$75.35	NA
Privacy	C23031	12	NA	\$61.20	\$61.20	\$61.20	NA
Passage	C23051	12	NA	\$59.90	\$59.90	\$59.90	NA
Dummy/Inactive	C23106	12	NA	\$29.30	\$29.30	\$29.30	NA

### Alwood



Function	Contractor Item #	Case Pack	Polished Brass (105)	Satin Nickel (119)	Polished Chrome (125)	Tuscan Bronze (150)	Matte Black (122)
Keyed Entry	C23013	12	\$72.45	\$75.35	\$75.35	\$75.35	NA
Privacy	C23032	12	\$58.05	\$61.20	\$61.20	\$61.20	NA
Passage	C23052	12	\$56.75	\$59.90	\$59.90	\$59.90	NA
Dummy/Inactive	C23107	12	\$28.05	\$29.30	\$29.30	\$29.30	NA

### Glenshaw



Function	Contractor Item #	Case Pack	Polished Brass (105)	Satin Nickel (119)	Polished Chrome (125)	Tuscan Bronze (150)	Matte Black (122)
Keyed Entry - Left Hand	C23014LH	12	\$72.45	\$75.35	NA	\$75.35	NA
Keyed Entry - Right Hand	C23014RH	12	\$72.45	\$75.35	NA	\$75.35	NA
Privacy	C23034	12	\$58.05	\$61.20	NA	\$61.20	NA
Passage	C23054	12	\$56.75	\$59.90	NA	\$59.90	NA
Dummy/Inactive - Left Hand	C23108LH	12	\$28.05	\$29.30	NA	\$29.30	NA
Dummy/Inactive - Right Hand	C23108RH	12	\$28.05	\$29.30	NA	\$29.30	NA

### Arnett



Function	Contractor Item #	Case Pack	Polished Brass (105)	Satin Nickel (119)	Polished Chrome (125)	Tuscan Bronze (150)	Matte Black (122)
Keyed Entry	C23015	12	NA	\$75.35	NA	\$75.35	NA
Privacy	C23035	12	NA	\$61.20	NA	\$61.20	NA
Passage	C23055	12	NA	\$59.90	NA	\$59.90	NA
Dummy/Inactive	C23109	12	NA	\$29.30	NA	\$29.30	NA

## DEADBOLTS

**Atria**



Function	Contractor Item #	Case Pack	Polished Brass (105)	Satin Nickel (119)	Polished Chrome (125)	Tuscan Bronze (150)	Matte Black (122)
Single Cylinder	C23064	12	NA	\$54.25	\$58.30	\$58.30	\$58.30

**Celia**



Function	Contractor Item #	Case Pack	Polished Brass (105)	Satin Nickel (119)	Polished Chrome (125)	Tuscan Bronze (150)	Matte Black (122)
Celia	C23170	12	NA	\$54.25	\$58.30	\$58.30	\$58.30

**Liam**



Function	Contractor Item #	Case Pack	Polished Brass (105)	Satin Nickel (119)	Polished Chrome (125)	Tuscan Bronze (150)	Matte Black (122)
Liam	C23169	12	NA	\$54.25	\$58.30	\$58.30	\$58.30

**Brynne**



Function	Contractor Item #	Case Pack	Polished Chrome (125)
Single Cylinder	C23068	12	\$58.30

**Almarrion**



Function	Contractor Item #	Case Pack	Polished Brass (105)	Satin Nickel (119)	Polished Chrome (125)	Tuscan Bronze (150)	Matte Black (122)
Single Cylinder	C23061	12	\$50.20	\$54.25	\$58.30	\$58.30	NA

**Weldon**



Function	Contractor Item #	Case Pack	Polished Brass (105)	Satin Nickel (119)	Polished Chrome (125)	Tuscan Bronze (150)	Matte Black (122)
Single Cylinder	C23063	12	\$50.20	\$54.25	\$58.30	\$58.30	NA

**Almarrion**



Function	Contractor Item #	Case Pack	Polished Brass (105)	Satin Nickel (119)	Polished Chrome (125)	Tuscan Bronze (150)	Matte Black (122)
UL, Single Cylinder	SF23065	Ea	\$55.55	\$60.65	\$63.65	\$63.65	NA

**Weldon**



Function	Contractor Item #	Case Pack	Polished Brass (105)	Satin Nickel (119)	Polished Chrome (125)	Tuscan Bronze (150)	Matte Black (122)
UL, Single Cylinder	SF23067	Ea	\$55.55	\$60.65	\$63.65	\$63.65	NA

**Note: UL Deadbolts available via special order; UL Knobs and Levers are available add an additional \$7.00 to the list price**

**HANDLESETS LIP, LEVER CHASSIS, INCLUDES DEADBOLT EXTERIOR**
**Anderson**

Function	Contractor Item #	Case Pack	Polished Brass (105)	Satin Nickel (119)	Polished Chrome (125)	Tuscan Bronze (150)
Handle and Liam Deadbolt Exterior	C23076LIP	4	NA	\$181.45	\$185.50	\$185.50

**Rhodes**

Function	Contractor Item #	Case Pack	Polished Brass (105)	Satin Nickel (119)	Polished Chrome (125)	Tuscan Bronze (150)
Handle and Almarion Deadbolt Exterior	C23074LIP	4	NA	\$181.45	\$185.50	\$185.50

**Rourke**

Function	Contractor Item #	Case Pack	Polished Brass (105)	Satin Nickel (119)	Polished Chrome (125)	Tuscan Bronze (150)
Handle and Almarion Deadbolt Exterior	C23075LIP	4	\$175.70	\$181.45	NA	\$185.50

**HANDLESETS LIP, KNOB CHASSIS, INCLUDES DEADBOLT EXTERIOR**
**Rhodes**

Function	Contractor Item #	Case Pack	Polished Brass (105)	Satin Nickel (119)	Polished Chrome (125)	Tuscan Bronze (150)
Handle and Almarion Deadbolt	C23079LIP	4	NA	\$181.45	\$185.50	\$185.50

**Rourke**

Function	Contractor Item #	Case Pack	Polished Brass (105)	Satin Nickel (119)	Polished Chrome (125)	Tuscan Bronze (150)
Handle and Almarion Deadbolt	C23080LIP	4	175.70	\$181.45	\$185.50	\$185.50

**HANDLESETS LIP, LEVER CHASSIS, EXCLUDES DEADBOLT**
**Anderson**

Function	Contractor Item #	Case Pack	Polished Brass (105)	Satin Nickel (119)	Polished Chrome (125)	Tuscan Bronze (150)
Handle Only	C23077LIP	4	NA	\$148.90	\$150.50	\$150.50

**Rhodes**

Function	Contractor Item #	Case Pack	Polished Brass (105)	Satin Nickel (119)	Polished Chrome (125)	Tuscan Bronze (150)
Handle Only	C23078LIP	4	NA	\$148.90	\$150.50	\$150.50

**DUMMY HANDLESETS LIP, KNOB CHASSIS, INCLUDES DUMMY DEADBOLT EXTERIOR**
**Rhodes**

Function	Contractor Item #	Case Pack	Polished Brass (105)	Satin Nickel (119)	Polished Chrome (125)	Tuscan Bronze (150)
Dummy Handle and Dummy Almarrion Deadbolt Exterior	C23201	4	NA	\$176.45	\$180.35	\$180.35

**Rourke**

Function	Contractor Item #	Case Pack	Polished Brass (105)	Satin Nickel (119)	Polished Chrome (125)	Tuscan Bronze (150)
Dummy Handle and Dummy Almarrion Deadbolt Exterior	C23202	4	\$170.40	\$176.45	NA	\$180.35

**DUMMY HANDLESETS LIP, LEVER CHASSIS, INCLUDES DUMMY DEADBOLT EXTERIOR**
**Anderson**

Function	Contractor Item #	Case Pack	Polished Brass (105)	Satin Nickel (119)	Polished Chrome (125)	Tuscan Bronze (150)
Dummy Handle and Dummy Liam Deadbolt Exterior	C23206	4	NA	\$176.45	\$180.35	\$180.35

**Rhodes**

Function	Contractor Item #	Case Pack	Polished Brass (105)	Satin Nickel (119)	Polished Chrome (125)	Tuscan Bronze (150)
Dummy Handle and Dummy Almarrion Deadbolt Exterior	C23204	4	NA	\$176.45	\$180.35	\$180.35

**Rourke**

Function	Contractor Item #	Case Pack	Polished Brass (105)	Satin Nickel (119)	Polished Chrome (125)	Tuscan Bronze (150)
Dummy Handle and Dummy Almarrion Deadbolt Exterior	C23205	4	\$170.40	\$176.45	NA	\$180.35

**KNOB AND DEADBOLT IP (INTERIOR PACK), INCLUDES KNOB, ROSE, LATCHES, DEADBOLT INTERIOR AND MOUNTING HARDWARE**

**Stafford**



Function	Contractor Item #	Case Pack	Polished Brass (105)	Satin Nickel (119)	Polished Chrome (125)	Tuscan Bronze (150)
Interior Passage Knob and Deadbolt Interior	C23146	4	\$42.00	\$45.70	NA	\$47.45

**Ganyon**



Function	Contractor Item #	Case Pack	Polished Brass (105)	Satin Nickel (119)	Polished Chrome (125)	Tuscan Bronze (150)
Interior Passage Knob and Deadbolt Interior	C23147	4	NA	\$45.70	\$47.45	\$47.45

**Lindingham**



Function	Contractor Item #	Case Pack	Polished Brass (105)	Satin Nickel (119)	Polished Chrome (125)	Tuscan Bronze (150)
Interior Passage Knob and Deadbolt Interior	C23148	4	NA	\$45.70	NA	\$47.45

**Webley**



Function	Contractor Item #	Case Pack	Polished Brass (105)	Satin Nickel (119)	Polished Chrome (125)	Tuscan Bronze (150)
Interior Passage Knob and Deadbolt Interior	C23149	4	\$42.00	\$45.70	NA	\$47.45

**Barrett**



Function	Contractor Item #	Case Pack	Polished Brass (105)	Satin Nickel (119)	Polished Chrome (125)	Tuscan Bronze (150)
Interior Passage Knob and Deadbolt Interior	C23150	4	\$42.00	\$45.70	NA	NA

**LEVER AND DEADBOLT IP (INTERIOR PACK), INCLUDES LEVER, ROSE, LATCH AND MOUNTING HARDWARE AND INTERIOR DEADBOLT**

**Anna**



Function	Contractor Item #	Case Pack	Polished Brass (105)	Satin Nickel (119)	Polished Chrome (125)	Tuscan Bronze (150)
Interior Passage Lever and Interior Liam Deadbolt	C23184	4	NA	\$57.50	\$59.10	\$59.10



**Lexa**

Function	Contractor Item #	Case Pack	Polished Brass (105)	Satin Nickel (119)	Polished Chrome (125)	Tuscan Bronze (150)
Interior Passage Lever and Interior Celia Deadbolt	C23185	4	NA	\$57.50	\$59.10	\$59.10

**Harper**

Function	Contractor Item #	Case Pack	Polished Brass (105)	Satin Nickel (119)	Polished Chrome (125)	Tuscan Bronze (150)
Interior Passage Lever and Interior Almarion Deadbolt	C23180	4	NA	\$57.50	\$59.10	\$59.10

**Alwood**

Function	Contractor Item #	Case Pack	Polished Brass (105)	Satin Nickel (119)	Polished Chrome (125)	Tuscan Bronze (150)
Interior Passage Lever and Interior Almarion Deadbolt	C23181	4	NA	\$57.50	\$59.10	\$59.10

**Glenshaw**

Function	Contractor Item #	Case Pack	Polished Brass (105)	Satin Nickel (119)	Polished Chrome (125)	Tuscan Bronze (150)
Interior Passage Lever and Interior Almarion Deadbolt	C23182LH	4	\$54.35	\$57.50	NA	\$59.10
Interior Passage Lever and Interior Almarion Deadbolt	C23182RH	4	\$54.35	\$57.50	NA	\$59.10

**Arnett**

Function	Contractor Item #	Case Pack	Polished Brass (105)	Satin Nickel (119)	Polished Chrome (125)	Tuscan Bronze (150)
Interior Passage Lever and Interior Almarion Deadbolt	C23183	4	NA	\$57.50	NA	\$59.10

**LEVER IP (INTERIOR PACK), INCLUDES LEVER, ROSE, LATCHES, AND MOUNTING HARDWARE**

**Anna**

Function	Contractor Item #	Case Pack	Satin Nickel (119)	Polished Chrome (125)	Tuscan Bronze (150)
Interior Passage Lever	C23187	4	\$35.80	\$35.80	\$35.80

**Lexa**

Function	Contractor Item #	Case Pack	Satin Nickel (119)	Polished Chrome (125)	Tuscan Bronze (150)
Interior Passage Lever	C23188	4	\$35.80	\$35.80	\$35.80

**Harper**

Function	Contractor Item #	Case Pack	Polished Brass (105)	Satin Nickel (119)	Polished Chrome (125)	Tuscan Bronze (150)
Interior Passage Lever	C23186	4	NA	\$35.80	\$35.80	\$35.80

**Alwood**

Function	Contractor Item #	Case Pack	Polished Brass (105)	Satin Nickel (119)	Polished Chrome (125)	Tuscan Bronze (150)
Interior Passage Lever	C23189	4	NA	\$35.80	\$35.80	\$35.80

**Glenshaw**

Function	Contractor Item #	Case Pack	Polished Brass (105)	Satin Nickel (119)	Polished Chrome (125)	Tuscan Bronze (150)
Interior Passage Lever - Left Hand	C23190LH	4	\$34.50	\$35.80	NA	\$35.80
Interior Passage Lever - Right Hand	C23190RH	4	\$34.50	\$35.80	NA	\$35.80

**Arnett**

Function	Contractor Item #	Case Pack	Polished Brass (105)	Satin Nickel (119)	Polished Chrome (125)	Tuscan Bronze (150)
Interior Passage Lever	C23191	4	NA	\$35.80	NA	\$35.80

**INTERCONNECTED LOCKS**
**Harper (interior)**

Function	Contractor Item #	Case Pack	Satin Nickel (119)	Polished Chrome (125)	Tuscan Bronze (150)
Single Locking	SF23251	6	\$224.70	\$224.70	\$224.70
Double Locking	SF23212	6	\$246.10	\$246.10	\$246.10

**Alwood (interior)**



Function	Contractor Item #	Case Pack	Satin Nickel (119)	Polished Chrome (125)	Tuscan Bronze (150)
Single Locking	SF23252	6	\$224.70	\$224.70	\$224.70
Double Locking	SF23213	6	\$246.10	\$246.10	\$246.10

**Anna (interior)**

Function	Contractor Item #	Case Pack	Satin Nickel (119)	Polished Chrome (125)	Tuscan Bronze (150)
Single Locking	SF23253	6	\$224.70	\$224.70	\$224.70
Double Locking	SF23214	6	\$246.10	\$246.10	\$246.10

## SERVICE PARTS

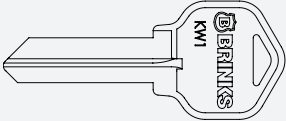
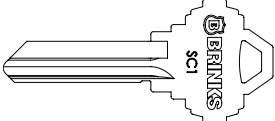
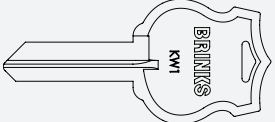
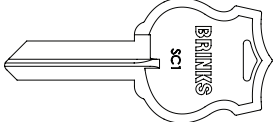
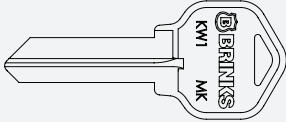
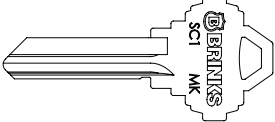
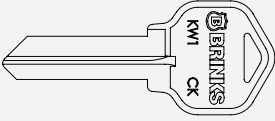
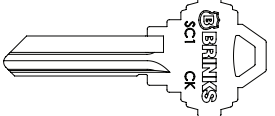
### KEYS

	Part Number	Description	List Price
	881-10005	KW1 bow, nickel plated, 5 pin	\$1.40
	881-10002	SC1 bow, nickel plated, 5 pin	\$1.40
	881-10006	Brinks bow, KW1, nickel plated, 5 pin	\$1.40
	881-10007	Brinks bow, SC1, nickel plated, 5 pin	\$1.40
	881-10011	KW1 bow master key, nickel plated, 5 pin	\$1.40
	881-10012	SC1 bow master key, nickel plated, 5 pin	\$1.40
	881-10013	KW1 bow construction key, brass, 5 pin	\$1.40
	881-10014	SC1 bow construction key, brass 5 pin	\$1.40

Cut key charge \$4.00

## KEYING CHARGES

Specialty Keying	List Price Per Item
Keyed Alike (KA)	N/C
Master Keying (MK)	\$2.75
Construction Keying (CK)	\$2.75
Construction Master Keying (CMK)	\$4.75
Grand Master Keying (GMK)	\$7.75
Maison (MAS)	\$6.75

Note: On entry levers, the construction balls are on the non-working side. The cylinder must be rotated clockwise to empty the construction balls.

## CYLINDERS

### KW1

Keying Options	Polished Brass	Satin Nickel	Polished Chrome	Tuscan Bronze	Matte Black	List Price	Case Qty
Knob KD	865-00012-12KD	865-00011-12KD	NA	865-00013-12KD	NA	\$7.50	12
Knob KA12	865-00012-12KA	865-00011-12KA	NA	865-00013-12KA	NA	\$7.50	12
Lever KD	865-00022-12KD	865-00021-12KD	865-00024-12KD	865-00023-12KD	865-00079-12KD	\$7.50	12
Lever KA12	865-00022-12KA	865-00021-12KA	865-00024-12KA	865-00023-12KA	865-00079-12KA	\$7.50	12
Transitional Deadbolt KD	NA	865-00131-12KD	865-00134-12KD	865-00133-12KD	865-00180-12KD	\$8.00	12
Transitional Deadbolt KA12	NA	865-00131-12KA	865-00134-12KA	865-00133-12KA	865-00180-12KA	\$8.00	12
Atria/Brynne Deadbolt KD	NA	865-00015	865-00016	865-00017	865-00077	\$8.00	12
Interconnected Deadbolt Only	NA	865-00070-12KD	865-00070-12KD	865-00071-12KD	NA	\$9.00	12
Interconnected Deadbolt and Lever Set	NA	865-00072-12KD	865-00072-12KD	865-00073-12KD	NA	\$16.50	12

### SC1

Keying Options	Polished Brass	Satin Nickel	Polished Chrome	Tuscan Bronze	Matte Black	List Price	Case Qty
Knob KD	865-00042-12KD	865-00041-12KD	NA	865-00043-12KD	NA	\$7.50	12
Knob KA12	865-00042-12KA	865-00041-12KA	NA	865-00043-12KA	NA	\$7.50	12
Lever KD	865-00052-12KD	865-00051-12KD	865-00054-12KD	865-00053-12KD	865-00081-12KD	\$7.50	12
Lever KA12	865-00052-12KA	865-00051-12KA	865-00054-12KA	865-00053-12KA	865-00081-12KA	\$7.50	12
Transitional Deadbolt KD	NA	865-00161-12KD	865-00164-12KD	865-00163-12KD	865-00182-12KD	\$8.00	12
Transitional Deadbolt KA12	NA	865-00161-12KA	865-00164-12KA	865-00163-12KA	865-00182-12KA	\$8.00	12
Atria/Brynne Deadbolt KD	NA	865-00055	865-00056	865-00057	865-00078	\$8.00	12
Interconnected Deadbolt Only	NA	865-00065	865-00065	865-00067-12KD	NA	\$9.00	12
Interconnected Deadbolt and Lever Set	NA	865-00066	865-00066	865-00068-12KD	NA	\$16.50	12

# LATCHES

## LATCHES

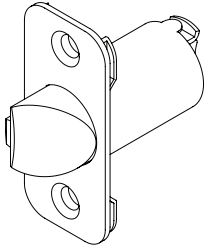
**LE6**

Part Number	Description	Quantity	List Price
922-00020	2 3/8" Entry Latch Satin Nickel	12	\$6.40
922-00019	2 3/8" Entry Latch Polished Brass	12	\$6.40
922-00021	2 3/8" Entry Latch Tuscan Bronze	12	\$6.40
922-00031	2 3/8" Entry Latch Polished Chrome	12	\$6.40
922-00056	2 3/8" Entry Latch Matte Black	12	\$6.40

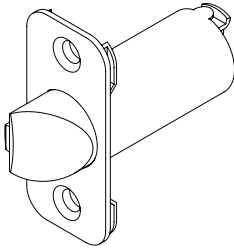
**LE7**

Part Number	Description	Quantity	List Price
922-00023	2 3/4" Entry Latch Satin Nickel	12	\$6.40
922-00022	2 3/4" Entry Latch Polished Brass	12	\$6.40
922-00024	2 3/4" Entry Latch Tuscan Bronze	12	\$6.40
922-00033	2 3/4" Entry Latch Polished Chrome	12	\$6.40
922-00057	2 3/4" Entry Latch Matte Black	12	\$6.40

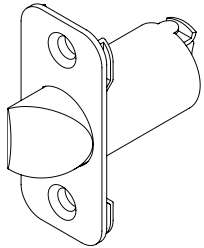
**LS6**

Part Number	Description	Quantity	List Price
922-00026	2 3/8" Spring Latch Satin Nickel	12	\$5.90
922-00025	2 3/8" Spring Latch Polished Brass	12	\$5.90
922-00027	2 3/8" Spring Latch Tuscan Bronze	12	\$5.90
922-00034	2 3/8" Spring Latch Polished Chrome	12	\$5.90
922-00058	2 3/8" Spring Latch Matte Black	12	\$5.90

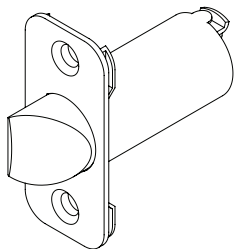
**LS7**

Part Number	Description	Quantity	List Price
922-00029	2 3/4" Spring Latch Satin Nickel	12	\$5.90
922-00028	2 3/4" Spring Latch Polished Brass	12	\$5.90
922-00030	2 3/4" Spring Latch Tuscan Bronze	12	\$5.90
922-00035	2 3/4" Spring Latch Polished Chrome	12	\$5.90
922-00059	2 3/4" Spring Latch Matte Black	12	\$5.90

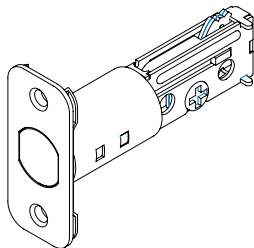
**LDB**

Part Number	Description	Quantity	List Price
922-00036	Adjustable DB Latch Satin Nickel	12	\$10.15
922-00037	Adjustable DB Latch Polished Brass	12	\$10.15
922-00038	Adjustable DB Latch Tuscan Bronze	12	\$10.15
922-00039	Adjustable DB Latch Polished Chrome	12	\$10.15
922-00060	Adjustable DB Latch Matte Black	12	\$10.15

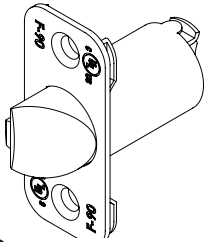
**LEU6**

Part Number	Description	Quantity	List Price
922-00201	UL 2 3/8" Entry Latch Satin Nickel	12	\$11.80
922-00202	UL 2 3/8" Entry Latch Polished Brass	12	\$11.80
922-00203	UL 2 3/8" Entry Latch Tuscan Bronze	12	\$11.80
922-00204	UL 2 3/8" Entry Latch Polished Chrome	12	\$11.80
922-00061	UL 2 3/8" Entry Latch Matte Black	12	\$11.80

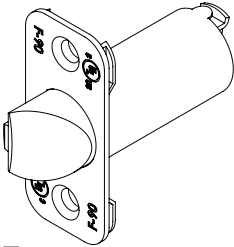
**LEU7**

Part Number	Description	Quantity	List Price
922-00205	UL 2 3/4" Entry Latch Satin Nickel	12	\$11.80
922-00206	UL 2 3/4" Entry Latch Polished Brass	12	\$11.80
922-00207	UL 2 3/4" Entry Latch Tuscan Bronze	12	\$11.80
922-00208	UL 2 3/4" Entry Latch Polished Chrome	12	\$11.80
922-00062	UL 2 3/4" Entry Latch Matte Black	12	\$11.80

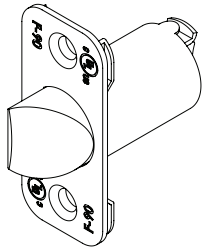
**LSU6**

Part Number	Description	Quantity	List Price
922-00209	UL 2 3/8" Spring Latch Satin Nickel	12	\$10.70
922-00210	UL 2 3/8" Spring Latch Polished Brass	12	\$10.70
922-00211	UL 2 3/8" Spring Latch Tuscan Bronze	12	\$10.70
922-00212	UL 2 3/8" Spring Latch Polished Chrome	12	\$10.70
922-00063	UL 2 3/8" Spring Latch Matte Black	12	\$10.70

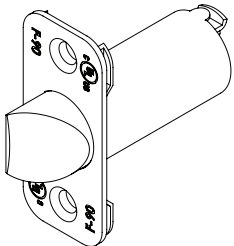
**LSU7**

Part Number	Description	Quantity	List Price
922-00213	UL 2 3/4" Spring Latch Satin Nickel	12	\$10.70
922-00214	UL 2 3/4" Spring Latch Polished Brass	12	\$10.70
922-00215	UL 2 3/4" Spring Latch Tuscan Bronze	12	\$10.70
922-00216	UL 2 3/4" Spring Latch Polished Chrome	12	\$10.70
922-00064	UL 2 3/4" Spring Latch Matte Black	12	\$10.70

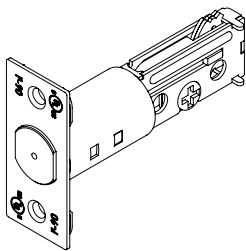
**LDBU**

Part Number	Description	Quantity	List Price
922-00217	UL Adjustable Deadbolt Latch Satin Nickel	12	\$11.80
922-00218	UL Adjustable Deadbolt Latch Polished Brass	12	\$11.80
922-00219	UL Adjustable Deadbolt Latch Tuscan Bronze	12	\$11.80
922-00220	UL Adjustable Deadbolt Latch Polished Chrome	12	\$11.80
922-00065	UL Adjustable Deadbolt Latch Matte Black	12	\$11.80

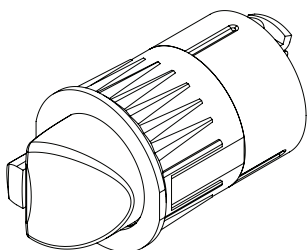

**LEDI**

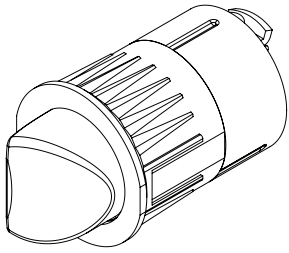
Part Number	Description	Quantity	List Price
922-00401	Drive-in 2 3/8" Entry Latch	12	\$6.40
922-00402	Drive-in 2 3/4" Entry Latch	12	\$6.40

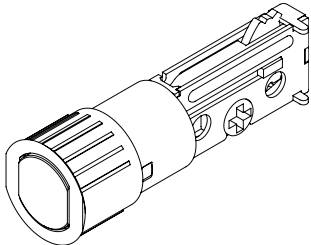

**LSDI**

Part Number	Description	Quantity	List Price
922-00403	Drive-in 2 3/8" Spring Latch	12	\$5.90
922-00404	Drive-in 2 3/4" Spring Latch	12	\$5.90



**LDBDI**

Part Number	Description	Quantity	List Price
922-00040	Adjustable drive-in deadbolt latch	12	\$10.15

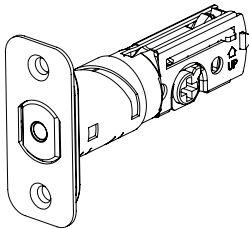

**Atria/Bryenne**

Part Number	Description	Quantity	List Price
922-00053	Atria/Bryenne adjustable 4-Way deadbolt Latch, Polished Chrome/Satin Nickel	12	\$10.15
922-00054	Atria/Bryenne adjustable 4-Way deadbolt Latch, Tuscan Bronze Matte Black	12	\$10.15

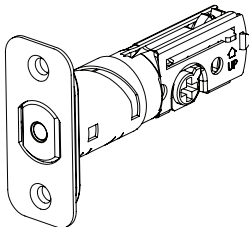

**ICDB**

Part Number	Description	Quantity	List Price
922-00260	Latch, interconnected Lock, 4-way keyed entry, UL 3 hour fire rated, Satin Nickel	12	\$11.80
922-00261	Latch, interconnected Lock, 4-way keyed entry, UL 3 hour fire rated, Tuscan Bronze	12	\$11.80
922-00262	Latch, interconnected lock, 4-way spring (passage), UL 3 hour fire rated, Satin Nickel	12	\$10.70
922-00263	Latch, interconnected lock, 4-way spring (passage), UL 3 hour fire rated, Tuscan Bronze	12	\$10.70
922-00264	Latch, interconnected lock, deadbolt, UL 3 hour fire rated, Satin Nickel	12	\$11.80
922-00265	Latch, interconnected lock, deadbolt, UL 3 hour fire rated, Tuscan Bronze	12	\$11.80

# STRIKES

## STRIKES

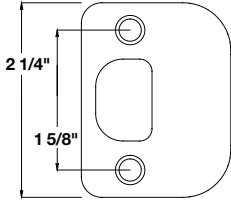

**SEFR**

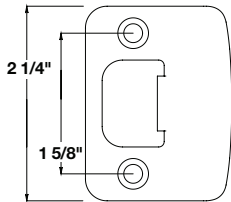

**SEFL**

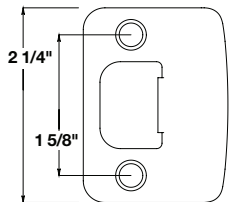

**SPFL**

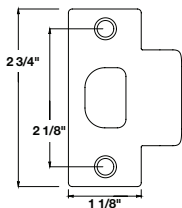

**T**

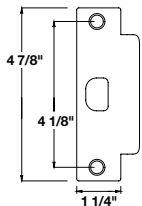

**ASA**

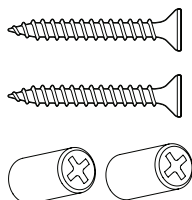

**ACCESSORIES**

Part Number	Description	List Price
919-00301	Entry Full Rim Satin Nickel	\$3.20
919-00302	Entry Full Rim Polished Brass	\$3.20
919-00303	Entry Full Rim Tuscan Bronze	\$3.20
919-00304	Entry Full Rim Polished Chrome	\$3.20
919-00012	Entry Full Rim Matte Black	\$3.20

Part Number	Description	List Price
919-00401	Entry Full Lip Satin Nickel	\$3.20
919-00402	Entry Full Lip Polished Brass	\$3.20
919-00403	Entry Full Lip Tuscan Bronze	\$3.20
919-00404	Entry Full Lip Polished Chrome	\$3.20
919-00013	Entry Full Lip Matte Black	\$3.20

Part Number	Description	List Price
919-00008	Passage Full Lip Satin Nickel	\$3.20
919-00007	Passage Full Lip Polished Brass	\$3.20
919-00009	Passage Full Lip Tuscan Bronze	\$3.20
919-00010	Passage Full Lip Polished Chrome	\$3.20
919-00014	Passage Full Lip Matte Black	\$3.20

Part Number	Description	List Price
919-00101	T Strike Satin Nickel	\$3.75
919-00102	T Strike Polished Brass	\$3.75
919-00103	T Strike Tuscan Bronze	\$3.75
919-00104	T Strike Polished Chrome	\$3.75
919-00015	T Strike Matte Black	\$3.75

Part Number	Description	List Price
919-00205	ASA Strike Satin Nickel	\$7.50
919-00206	ASA Strike Polished Brass	\$7.50
919-00207	ASA Strike Tuscan Bronze	\$7.50
919-00208	ASA Strike Polished Chrome	\$7.50
919-00016	ASA Strike Matte Black	\$7.50

Part Number	Description	List Price
901-00060	Strike plate screws, #10 x 3" long, pack of 2, Polished Brass	\$3.20
901-00061	Strike plate screws, #10 x 3" long, pack of 2, Polished Chrome	\$3.20
901-00062	Strike plate screws, #10 x 3" long, pack of 2, Black	\$3.20
850-00020	Hex to Phillips head adaptor for lever	\$3.20



## PINNING KITS

### KW1

Part Number	Description	Quantity	List Price
893-00273	Complete KW1 pinning kit	1	\$246.10
893-23001-100	Pin bottom #1 KW1	100	\$5.00
893-23002-100	Pin bottom #2 KW1	100	\$5.00
893-23003-100	Pin bottom #3 KW1	100	\$5.00
893-23004-100	Pin bottom #4 KW1	100	\$5.00
893-23005-100	Pin bottom #5 KW1	100	\$5.00
893-23006-100	Pin bottom #6 KW1	100	\$5.00
893-23301-100	Pin #1 master wafer KW1	100	\$5.00
893-23302-100	Pin #2 master wafer KW1	100	\$5.00
893-23303-100	Pin #3 master wafer KW1	100	\$5.00
893-23304-100	Pin #4 master wafer KW1	100	\$5.00
893-23305-100	Pin #5 master wafer KW1	100	\$5.00
893-23306-100	Pin #6 master wafer KW1	100	\$5.00
893-23555-100	Pin, top KW1 .180"	100	\$5.00
893-23777-100	Pin, spool KW1 .180"	100	\$5.00
893-23333-100	Pin, top KW1 .160"	100	\$5.00
893-23444-100	Pin, spool KW1 .160"	100	\$5.00
909-26401-50	Top pin spring KW1 knob/deadbolt	50	\$5.00
909-26501-25	Top pin spring KW1/SC1 lever	25	\$2.50
898-98610-25	C-Clip	25	\$2.50
999-26625	Key decoder KW1/SC1	1	\$10.00
921-00236	Plug follower	1	\$8.00
898-10243-25	Cap retainer pin for deadbolt	25	\$5.00
898-10291-25	Cap retainer spring for deadbolt	25	\$5.00
879-00001-25	Plastic insert for cylinder	25	\$5.00
883-00076-24	Warning label	24	\$5.00
901-20002-10	Cylinder retainer screw with built-in washer for deadbolt	10	\$5.00
851-75001-100	Construction Ball KW1 #4/SC1 #6	100	\$7.50
851-75002-100	Construction Ball KW1 #2/SC1 #3	100	\$7.50

### SUPPLEMENTAL

Part Number	Description	Quantity	List Price
893-00275	Supplemental pinning kit	1	\$70.00
901-20002	Cylinder retainer screw with built-in washer for deadbolt	10	\$5.00
898-98610	C-Clip	25	\$5.00
898-10291	Cap retainer spring for deadbolt	25	\$5.00
898-10243	Cap retainer pin for deadbolt	25	\$5.00
883-00076	Warning Label	24	\$5.00

## PINNING KITS

### SUPPLEMENTAL

879-00001	Plastic insert for cylinder	25	\$5.00
921-00236	Plug follower	1	\$8.00
909-26401	Top pin spring KW1 knob/deadbolt	25	\$5.00
909-26501	Top pin spring SC1	25	\$5.00
865-00010	Deadbolt Cylinder Top Pin Cap	25	\$5.00

### SC1

Part Number	Description	Quantity	List Price
893-00274	Complete SC1 pinning kit	1	\$246.10
893-21000-100	Pin bottom #0 SC1	100	\$5.00
893-21001-100	Pin bottom #1 SC1	100	\$5.00
893-21002-100	Pin bottom #2 SC1	100	\$5.00
893-21003-100	Pin bottom #3 SC1	100	\$5.00
893-21004-100	Pin bottom #4 SC1	100	\$5.00
893-21005-100	Pin bottom #5 SC1	100	\$5.00
893-21006-100	Pin bottom #6 SC1	100	\$5.00
893-21007-100	Pin bottom #7 SC1	100	\$5.00
893-21008-100	Pin bottom #8 SC1	100	\$5.00
893-21009-100	Pin bottom #9 SC1	100	\$5.00
893-21302-100	Pin #2 master wafer SC1	100	\$5.00
893-21303-100	Pin #3 master wafer SC1	100	\$5.00
893-21304-100	Pin #4 master wafer SC1	100	\$5.00
893-21305-100	Pin #5 master wafer SC1	100	\$5.00
893-21306-100	Pin #6 master wafer SC1	100	\$5.00
893-21307-100	Pin #7 master wafer SC1	100	\$5.00
893-21308-100	Pin #8 master wafer SC1	100	\$5.00
893-21309-100	Pin #9 master wafer SC1	100	\$5.00
893-21555-100	Pin, top SC1 #3 .165"	100	\$5.00
893-21444-100	Pin, spool SC1 #3 .165"	100	\$5.00
909-26501-25	Top pin spring SC1	25	\$2.50
898-98610-25	C-Clip	25	\$2.50
999-26525	Key decoder KW1/SC1	1	\$10.00
921-00236	Plug follower	1	\$8.00
898-10243-25	Cap retainer pin for deadbolt	25	\$5.00
898-10291-25	Cap retainer spring for deadbolt	25	\$5.00
879-00001-25	Plastic insert for cylinder	25	\$5.00
883-00076-24	Warning label	24	\$5.00
901-20002-10	Cylinder retainer screw with built-in washer for deadbolt	10	\$5.00
851-75001-100	Construction Ball KW1 #4/SC1 #6	100	\$7.50
851-75002-100	Construction Ball KW1 #2/SC1 #3	100	\$7.50

# Terms & Conditions

## TERMS AND CONDITIONS OF SALE

Standard terms are 2% prompt payment discount for payment within 30 days from date of invoice; net 31 days from the date of invoice. Hampton Products International (HPI) reserves the right to charge and recover on invoices which are not paid within the above terms, a service charge of 1-1/2% a month for each month or fraction thereof during which the invoice remains unpaid, said service charge, however, not to exceed the highest applicable legal rate of interest. All orders, whether solicited or written by HPI sales representatives or forwarded by our customers are deemed to be mere offers to purchase in accordance with these Terms and Conditions of Sale until actually accepted by us at our home office in Foothill Ranch, CA. HPI reserves the right to refuse any order as well as the right to sell or not sell to any firm at our sole discretion. The acceptance of an order is expressly made conditional upon your assent to these Conditions of Sale. HPI objects to the inclusion of any different or additional terms or conditions, even if the same are included in your order, a contract of sale will result upon the Terms and Conditions of Sale stated herein only. All sales are final.

## PRICES

Pricing based on full-case quantities only; orders for less than full case will be automatically adjusted up to the next full-case quantity. All prices are subject to change without notice and are not guaranteed. All taxes, duties or other charges are the responsibility of the customer.

## CLAIMS

Price claims must be submitted in writing to Hampton Products, 50 Icon, Foothill Ranch, CA 92610, within 80 days from the date of invoice.

## CHANGES OR CANCELLATIONS

Beyond 2 working days of our acknowledgement date no changes can be made. Additions to an order will be handled as a separate order and must meet applicable minimum order requirements. Order cancellation on regular stock items only, or any portion thereof is allowed only upon prior written consent from HPI, and the payment of cancellation charges deemed appropriate.

## MINIMUM CHARGE

No order will be invoiced for less than \$100.00 net plus shipping charges except for lock accessory parts.

## MINIMUM ANNUAL SALES VOLUME

HPI reserves the right to discontinue direct sales to any customer who does not meet the minimum annual sales volume requirement. The current annual requirement is \$10,000. Your annual purchases are determined by accepted, non-cancelled, and shipped orders received during each calendar year. HPI reserves the right to change any or all minimum annual sales volume requirements at any time. Any customer who does not meet the annual sales volume requirements may continue to purchase HPI products through an HPI distributor.

## RETURNS

Defective merchandise returned to 50 Icon Foothill Ranch, CA, requires prior written authorization from an HPI sales representative. A return authorization must accompany the returned shipment. The return authorization must include an itemized listing of the merchandise and an explanation stating the reason for return. There will be a 20% product restocking fee on all returned merchandise.

## FREIGHT

All goods are invoiced FOB 50 Icon, Foothill Ranch, CA, 92610. Upon delivery of shipments to the carrier, title to, and the risk of loss or damage in transit for such shipments, passes to the customer. HPI's standard policy is to pay freight charges on all orders over \$500 net invoice value to a single destination in the continental U.S., by carrier and route of our choice. Shipments less than these quantities will not be shipped on a prepaid basis. If higher freight charges are incurred from customers specifying a carrier or route of their choice the additional cost will be added to that customer's invoice.

## DELIVERY CONDITIONS

Shipping schedules are our best estimates, and cannot be guaranteed. HPI is not responsible for any direct or consequential loss or damage resulting from an inability or delay in meeting shipping schedules.

## LIMITED LIFE TIME WARRANTY

This product is warranted by Hampton Products International ("HPI") to the original consumer purchaser against defects in material and workmanship under normal use and service for the life of the product. This warranty does not apply to product: used in commercial or common area applications; used for purposes for which it was not designed or intended; or which has been abused, misused, modified, or improperly installed, operated, maintained, and/or repaired. This warranty does not cover scratches, abrasions, or deterioration due to the use of paints, solvents, or other chemicals. HPI IS NOT LIABLE FOR

INCIDENTAL, INDIRECT, OR CONSEQUENTIAL DAMAGES. Some states do not allow the exclusion or limitation of incidental or consequential damages, so the above limitation or exclusion may not apply to you. This warranty gives you specific legal rights, and you may also have other rights which vary from state to state. To make a warranty claim for repair or replacement, visit [www.hampton.care](http://www.hampton.care) or contact Hampton Care at 1-800-562-5625. Return of defective product and receipt may be required for warranty claims.

## PATENT INDEMNITY AND TRADEMARKS

No person or entity may sell, distribute, advertise, market or promote HPI, Brinks, Brinks Home Security or other private label branded products distributed by HPI, without prior written authorization from HPI. Customers of HPI who are authorized to sell Hampton, Brinks, Brinks Home Security and/or other private label branded products are referred to herein as "Customers."

The Hampton brand, and all other licensed/private label brand products, are the sole property of HPI or HPI has legal rights to use the trademark, graphics or logo, (the "Marks"), and such Marks remain under the sole and exclusive authority rights of HPI and nothing arising out of the relationship between HPI and any Customer conveys to Customer any ownership rights in the Marks. Customers may use the Marks and then only in the sale or promotion of authentic HPI products in compliance with the terms of this policy. The Marks must be used exactly in the form provided and in conformity with all HPI and licensed trademark usage policies or guidelines, including, but not limited to, those related to shape, color match and imprint quality. Any proposed deviation must be approved in writing by HPI prior to use. The Marks may not be used in or as part of any Customer domain name or the Internet. Prior to any use of the Marks on goods or services, Customers must submit samples for HPI's approval.

Additionally, no Customer may use product depictions, graphics, logos or text relating to HPI products (or its licensed or private label brand) that have not been provided by HPI in connection with the advertising, promotion or sale of HPI products without HPI's prior review and written approval of each such use. The Marks may not be used in or as part of any reseller or other third party (i) domain name or VRL or the Internet, (ii) trademark or service mark, or (iii) company or trade name. Any action on the part of a Customer that violates the terms and condition of sale of this policy or otherwise impairs the value of or goodwill associated with the Marks or is otherwise not in conformity with HPI's standards may result in the suspension or termination of the Customer's authorization or any other remedy permitted by law.

HPI grants to each of its Customers limited, non-transferable, non-sublicenseable licenses of the patents relating to the HPI products that the Customer is authorized to sell and of the copyrights in any packaging or other written materials included therewith or relating thereto. Said patent and copyright licenses are solely to sell such HPI, or its licensed or private label brand, products covered by such patents and to which such copyrights relate only to the end-user and other Customers in compliance with the terms and conditions of this document. The sales of such patented HPI products and the sale or use of such copyrighted materials by a Customer that violate the terms and conditions of this document exceed the scope of the licenses herein granted to the Customer and may constitute patent and/or copyright infringement.

## STANDARDS

HPI meets or exceeds the testing requirements specified for each product grade or rating.

- American National Standards Institute (ANSI)
- Underwriters Laboratories, Inc. (UL)
- Americans with Disabilities Act (ADA)

## MISCELLANEOUS

Substitution of non-HPI components/parts, and any alteration or modification of factory parts, and other lock manufacturer's parts may result in door hardware which does not function properly or will fail and will void all warranties. Orders not specified with keying requirements will be shipped keyed alike in groups of 3 (KA). Orders with keying requirements of KA12 or more must have a "Letter of Release" on file with HPI stating that HPI will not be held liable for cost and expense arising from any loss or damage to property utilizing HPI products where 12 or more locks have been keyed alike. Contact your Sales Office account representative for a copy of the release form. HPI reserves the right to revise or modify products, product information, or pricing without notice. Product specifications and pricing reflect available information at the time of printing. HPI is not responsible for typographic or printing errors.



# PUSH PULL ROTATE DOOR LOCKS™



## The Door Lock That **3** WAYS OPENS



50 Icon, Foothill Ranch, CA 92610  
www.pprlocks.com

© 2021 Hampton Products International Corp.  
1-800-562-5625  
84000-00011\_REVE 05/21