

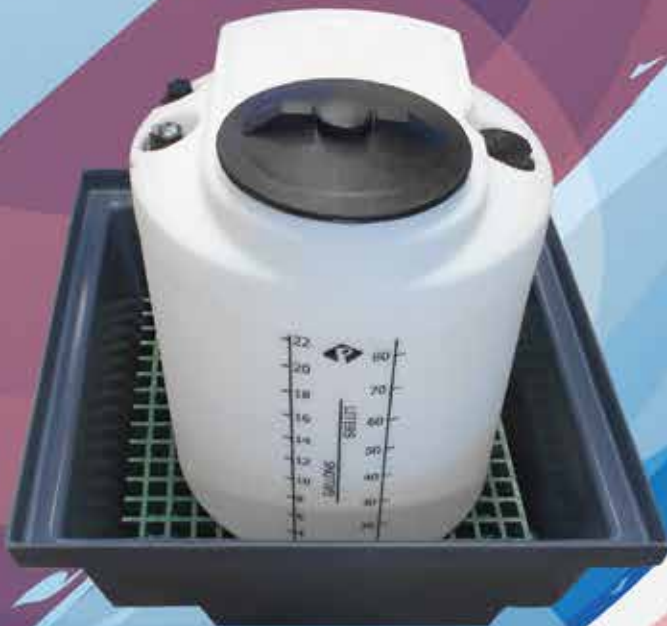

PEABODY
rotational molding

No Boundaries.™

Effective January 2020



Products

ProChem® Tank Systems	4
Process Chemical Tanks.....	4
Process Potable Water Tanks	4
Open Top Process Chemical Tanks	6
Open Top Rectangular Chemical Tanks	6
Solid Top Process Chemical Tanks	6
Cone Bottom Tanks.....	20
Gemini Dual Containment®	8
Gemini Dual Containment® - CLO2.....	9
Gemini Dual Containment® - Cylindrical.....	9
Gemini Dual Containment® - Square.....	9
Gemini® PLUS.....	10
Gemini® PLUS Accessories.....	11
Gemini² MCU™ - Multiple Chemical Unit.....	12
Enclosure Products.....	14
PCS Pump Containment Enclosure.....	14
Pump Containment Enclosure - FRP Stands.....	14
Pump Containment Enclosure - Optional Accessories.....	14
Pump Turtle.....	14
PCS-PLUS Pump Containment Enclosure.....	15
PCS-PRO Fiberglass Pump and Equipment Enclosures	16
Aquarius Tapered Chemical Feed Tanks	17
Closed Top Rectangular Tanks.....	17
Gemini® Pump Pup™ Pump Pedestal	17
Cone Bottom Tanks - TD Series	18
Stands for Cone Bottom Tanks - TD Series.....	18
ProChem® Tank Stacker™	19
Stands.....	19
Forklift Tank Stand.....	19
For ProChem® Cone Bottom Tanks.....	21
For ProChem® and Gemini Tanks	23
Containment Products	22
Gemini® ChemFeed™ Bin.....	22
ProChem® Containment Basin.....	22
ProChem® PailVault™	24
Optional Accessories.....	24
ProChem® PailVault™ PLUS.....	25
Float Gauges for Gemini® Tanks	26
Gemini® Mini-Inverse Float Level Indication Systems	27
ProChem® LS - Ultrasonic.....	28
Level & Leak Detection Products.....	29
Level Indication and Control.....	29
Leak Detection	30

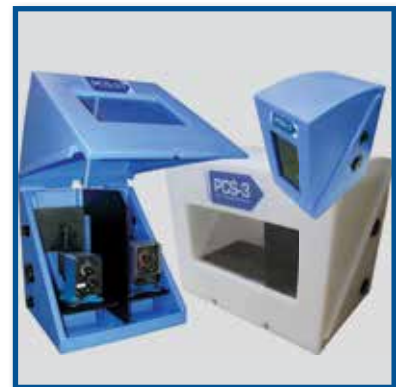

Steel Tank Dollies.....	31
Gemini® Tank Dolly - Cylindrical.....	31
Gemini® Tank Dolly - Square.....	31
ProChem® Tank Dolly	31
Seismic FiberRing	32
For Gemini Dual Containment® Tanks.....	32
FiberRings for Cylindrical Tanks.....	32
FiberRings for Square Tanks.....	32
FiberRings for Gemini® MCU™.....	32
For ProChem® Tank Systems.....	33
FiberRings for ProChem® Tanks	33
FiberRings for Open or Solid Top Tanks	33
ProChem® ClamShell Funnel.....	34
Tank Lids.....	35
Bolted Lids for ProChem® Open Top Process Chemical Tanks.....	35
Lids for Cone Bottom Tanks - TD Series	35
Tank Lids - Threaded Twist or Hinged Access Opening	36
Threaded Twist	36
Hinged Access Opening.....	36
ProChem® Lid Locking Kit	37
Gemini® Tank Fittings and Accessories	38
Gemini® Suction Tube Assembly	38
QCA Tank Fill Quick Connect Assembly.....	38
Gemini® Replacement Parts.....	39
Spin Weld Fittings.....	39
Gemini® Double Wall Fittings.....	39
3P Weather-Resistant Document Protectors	40
ProChem® Flexible Heating Blanket Systems for Gemini® and ProChem® Tanks.....	42
Tank Fittings	45
PVC, CPVC and PPL Bulkhead Fittings.....	46
Specialty and Small Bulkhead Fittings.....	46
Economy PPL Bulkhead Fittings.....	47
316 SST Bulkhead Fittings.....	47
PPL Full Drain Bottom Discharge Bolted Fittings.....	48
316 SST Deluxe Bolted Fittings.....	48
Self-Aligning Bulkhead Fittings.....	48
Welded Couplings.....	49
Welded Flanges - Polyethylene	49
Special Application Tanks	50
Sulfuric Acid and Sodium Hypochlorite.....	51
Hydrochloric Acid/Muriatic Acid.....	52
Hydrogen Peroxide and Caustics.....	52
Chlorine Dioxide and Other Chemicals and Other Resins.....	53
Engineered Tank Systems	54
Value-Paks Single Wall Tank HDPE.....	54
Value-Paks Double Wall Tank HDPE	56



Products

Tank Systems

ProChem® Tank Systems



Process Chemical Tanks 25 Gallons up to 1500 Gallons

ProChem® Tanks are designed for industrial process chemical applications where a single-walled design is desired. Every ProChem® Tank includes an integrally molded pump mounting platform on top and standard process fittings for fill and discharge of chemicals, water or food products. Supplied with a large vented access opening and easy to read calibration in liters and gallons, the ProChem® Tank offers standard features not previously available anywhere. LDPE & HDPE ProChem® Tanks are Certified NSF/ANSI 61 Compliant.

ProChem® Process Chemical Tanks are also available in *XLPE, PPL and PVDF (Kynar®)



Process Potable Water Tanks 25 Gallon up to 1500 Gallons

ProChem® Potable Water Tanks include an integrally molded pump mounting platform on top and standard process fittings for fill and discharge of water. Supplied with a large vented access opening and easy to read calibration in liters and gallons, the ProChem® Potable Water Tank offers standard features not previously available. Offered in Opaque Black and rated for water storage only. ProChem® Potable Water Tanks are FDA approved and Certified NSF/ANSI 61 Compliant. Rated for 1.0 Specific Gravity – Water Only.

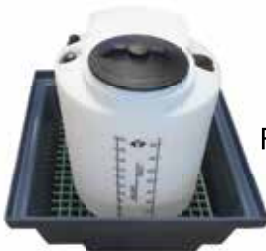

For Containment Basins and Stands see pages 20 & 21

* Kynar® is a registered trademark of Arkema





ProChem® Process Chemical Tanks

	Tank Size Gallon / Liter	Lid Size	Dia	Hgt	LDPE 1.5	LDPE 1.9	XLPE 1.9
	25 G / 95 L	8 in / 20.32 cm	19.5 in / 49.53 cm	26.25 in / 66.68 cm	-	† 01-31262	◆01-31322
	50 G / 189 L	8 in / 20.32 cm	19.5 in / 49.53 cm	47.25 in / 120.02 cm	-	† 01-31263	† 01-31323
	65 G / 246 L	8 in / 20.32 cm	23 in / 58.42 cm	43 in / 109.22 cm	-	† 01-32891	† 01-32894
	75 G / 284 L	8 in / 20.32 cm	27 in / 68.58 cm	40 in / 101.60 cm	-	† 01-31269	† 01-31329
	100 G / 379 L	8 in / 20.32 cm	27 in / 68.58 cm	47.75 in / 121.29 cm	-	† 01-31264	† 01-31324
	125 G / 473 L	8 in / 20.32 cm	27 in / 68.58 cm	59.25 in / 150.50 cm	-	† 01-31687	† 01-31693
	175 G / 662 L	8 in / 20.32 cm	34 in / 86.36 cm	55 in / 139.70 cm	-	† 01-31660	† 01-31663
NEW	200 G / 757 L	8 in / 20.32 cm	34 in / 86.36 cm	61 in / 154.94 cm	-	† 01-31266	† 01-31326
NEW	290 G / 1098 L	16 in / 40.64 cm	46 in / 116.84 cm	50 in / 127.00 cm	-	† 01-33337	† 01-33338
NEW	300 G / 1136 L	8 in / 20.32 cm	34 in / 86.36 cm	85 in / 215.90 cm	◆01-33832	◆01-33833	◆01-33834
	300 G / 1136 L	16 in / 40.64 cm	48 in / 121.92 cm	51.5 in / 130.81 cm	-	† 01-31268	† 01-31328
NEW	525 G / 1987 L	16 in / 40.64 cm	48 in / 121.92 cm	82 in / 208.28 cm	◆01-31278	◆01-31270	◆01-31330
NEW	550 G / 2082 L	16 in / 40.64 cm	73 in / 185.42 cm	45 in / 114.30 cm	◆01-33429	◆01-33430	◆01-33431
NEW	750 G / 2839 L	16 in / 40.64 cm	48 in / 121.92 cm	112 in / 284.48 cm	◆01-31280	◆01-33006	◆01-33009
NEW	1000 G / 3785 L	16 in / 40.64 cm	73 in / 185.42 cm	68 in / 172.72 cm	◆01-33046	◆01-33047	◆01-33048
COMING SOON	1500 G / 5678 L	16 in / 40.64 cm	73 in / 185.42 cm	96 in / 243.84 cm	◆01-33050	◆01-33051	◆01-33052

† NSF/ANSI 61 Compliant. ◆Not NSF/ANSI 61 compliant at this time.



ProChem® Potable Water Tanks

	Tank Size Gallon / Liter	Lid Size	Dia	Hgt	Black 1.0 Sp. Gr LDPE
	25 G / 95 L	8 in / 20.32 cm	19.5 in / 49.53 cm	26.25 in / 66.68 cm	01-31864
	50 G / 189 L	8 in / 20.32 cm	19.5 in / 49.53 cm	47.25 in / 120.02 cm	01-31865
	65 G / 246 L	8 in / 20.32 cm	23 in / 58.42 cm	43 in / 109.22 cm	01-32895
	75 G / 284 L	8 in / 20.32 cm	27 in / 68.58 cm	40 in / 101.60 cm	01-31866
	100 G / 379 L	8 in / 20.32 cm	27 in / 68.58 cm	47.75 in / 121.29 cm	01-31867
	125 G / 473 L	8 in / 20.32 cm	27 in / 68.58 cm	59.25 in / 150.50 cm	01-31868
	175 G / 662 L	8 in / 20.32 cm	34 in / 86.36 cm	55 in / 139.70 cm	01-31870
NEW	200 G / 757 L	8 in / 20.32 cm	34 in / 86.36 cm	61 in / 154.94 cm	01-31871
NEW	290 G / 1098 L	16 in / 40.64 cm	46 in / 116.84 cm	50 in / 127.00 cm	01-33339
NEW	300 G / 1136 L	8 in / 20.32 cm	34 in / 86.36 cm	85 in / 215.90 cm	01-33835
	300 G / 1136 L	16 in / 40.64 cm	48 in / 121.92 cm	51.5 in / 130.81 cm	01-31873
NEW	525 G / 1987 L	16 in / 40.64 cm	48 in / 121.92 cm	82 in / 208.28 cm	01-31874
NEW	550 G / 2082 L	16 in / 40.64 cm	73 in / 185.42 cm	45 in / 114.30 cm	01-33432
NEW	750 G / 2839 L	16 in / 40.64 cm	48 in / 121.92 cm	112 in / 284.48 cm	01-33010
NEW	1000 G / 3785 L	16 in / 40.64 cm	73 in / 185.42 cm	68 in / 172.72 cm	01-33049
COMING SOON	1500 G / 5678 L	16 in / 40.64 cm	73 in / 185.42 cm	96 in / 243.84 cm	01-33053



Products

ProChem® Tank Systems



Open Top Process Chemical Tanks LDPE, HDPE, XLPE, PPL, PVDF - Lid Included 5 Gallons up to 500 Gallons

Cylindrical Low Density Polyethylene open top tanks come standard with Dust Cover style lids. All tanks are standard natural polyethylene. Tanks are available in blue or black for 10% adder. Flat side of wall with molded in calibration charts for quick level indication available on tanks that come standard with lid. Black lettering is standard on these tanks. Tank diameter is of bottom cylinder, not overall lid dimension; height is from floor to top of lid. Open Top Tanks with LDPE construction are Certified NSF/ANSI 61 Compliant. ProChem® Open Top Tanks are also available in HDPE, XLPE, Polypropylene (PPL) and PVDF (Kynar). Contact customer service for pricing.



Open Top Rectangular Chemical Tanks LDPE - 86 Gallons

Our Rectangular Open top tank is great for applications where you need full access to the tank interior for applications like dipping, plating, cleaning filters or containing liquids. We offer a standard 86 gallon rectangular, but we have other sizes available. Please call customer service for help on special applications. Covers for open top rectangular tanks are sold separately.



Solid Top Process Chemical Tanks LDPE, HDPE, XLPE, PPL, PVDF 5 Gallons up to 500 Gallons

Our Cylindrical Tanks are also available with solid tops and equipped with a threaded twist lid for applications where a removable cover is not desired. Other than the solid cover, all other features are the same as our Open Top Cylindrical Tanks. Vertical Tanks with LDPE construction are Certified NSF/ANSI 61 Compliant. Also available in HDPE, XLPE, PPL and PVDF (Kynar). Contact customer service for pricing.





ProChem® Open Top Process Chemical Tanks

Tank Size w/Calibration & Lid	Shell Dia	OAH	Lid Dia	† LDPE	XLPE
5 G / 19 L	12 in / 30.48 cm	15 in / 38.1 cm	16 in / 40.64 cm	01-28958	01-30397
10 G / 38 L	15 in / 38.10 cm	18 in / 45.72 cm	19 in / 48.26 cm	01-28960	01-30398
10 G / 38 L (No Cover) ^	12 in / 30.48 cm	24 in / 60.96 cm	14 in / 35.56 cm	01-29433	01-30399
15 G / 57 L	15 in / 38.10 cm	25.5 in / 64.77 cm	19 in / 48.26 cm	01-28961	01-30400
30 G / 114 L	18 in / 45.72 cm	32.5 in / 82.55 cm	22 in / 55.88 cm	01-28963	01-30401
55 G / 208 L	24 in / 60.96 cm	32.5 in / 82.55 cm	28 in / 71.12 cm	01-28964	† 01-30402
100 G / 379 L	30 in / 76.20 cm	37.5 in / 95.25 cm	34 in / 86.36 cm	01-28967	† 01-30403
150 G / 568 L	30 in / 76.20 cm	54.5 in / 138.43 cm	34.5 in / 87.63 cm	01-28969	† 01-30404
200 G / 757 L	34 in / 86.36 cm	56.5 in / 143.51 cm	38 in / 96.52 cm	01-28972	† 01-30405
300 G / 1136 L	48 in / 121.92 cm	43.5 in / 110.49 cm	53 in / 134.62 cm	01-29052	† 01-30406
400 G / 1514 L	48 in / 121.92 cm	56.5 in / 143.51 cm	53 in / 134.62 cm	01-29053	† 01-30407
500 G / 1893 L	48 in / 121.92 cm	70.5 in / 179.07 cm	53 in / 134.62 cm	01-29054	† 01-30408

^ Special Nestable Tank (No Cover)

NEW ProChem® Open Top Rectangular Chemical Tanks

Tank Size	L	W	H	PN
86 G / 326 L	47.5 in / 120.65 cm	24 in / 60.96 cm	18 in / 45.72 cm	01-33380

* Cover Lid Sold Separately



ProChem® Solid Top Process Chemical Tanks

Tank Size	Shell Dia	Top Dia	OAH	Lid Size	† LDPE	XLPE
5 G / 19 L	12 in / 30.48 cm	16 in / 40.64 cm	19 in / 48.26 cm	8 in / 20.32 cm	01-30353	01-30409
10 G / 38 L	15 in / 38.10 cm	19 in / 48.26 cm	22 in / 55.88 cm	8 in / 20.32 cm	01-30354	01-30410
15 G / 57 L	15 in / 38.10 cm	27.5 in / 69.85 cm	29.5 in / 74.93 cm	8 in / 20.32 cm	01-30355	01-30411
30 G / 114 L	18 in / 45.72 cm	22 in / 55.88 cm	36.5 in / 92.71 cm	8 in / 20.32 cm	01-30356	01-30412
55 G / 208 L	24 in / 60.96 cm	28 in / 71.12 cm	36.5 in / 92.71 cm	8 in / 20.32 cm	01-30357	† 01-30413
100 G / 379 L	30 in / 76.20 cm	34 in / 86.36 cm	41.50 in / 105.41 cm	8 in / 20.32 cm	01-30358	† 01-30414
150 G / 568 L	30 in / 76.20 cm	34 in / 86.36 cm	58.5 in / 148.59 cm	8 in / 20.32 cm	01-30359	† 01-30415
200 G / 757 L	34 in / 86.36 cm	38 in / 96.52 cm	60.5 in / 153.67 cm	16 in / 40.64 cm	01-30360	† 01-30416
300 G / 1136 L	48 in / 121.92 cm	53 in / 134.62 cm	47.5 in / 120.65 cm	16 in / 40.64 cm	01-30361	† 01-30417
400 G / 1514 L	48 in / 121.92 cm	53 in / 134.62 cm	60.5 in / 153.67 cm	16 in / 40.64 cm	01-30362	† 01-30418
500 G / 1893 L	48 in / 121.92 cm	53 in / 134.62 cm	74.5 in / 189.23 cm	16 in / 40.64 cm	01-30363	† 01-30419



For Containment Basins and Stands see pages 20 & 21



Products

Gemini Dual Containment®



Cylindrical

15 Gallons up to 500 Gallons

Square

5 Gallons up to 175 Gallons

Features & Benefits of Gemini Dual Containment® Tank Systems

- All Peabody Gemini® tanks made from LDPE are available WQA Gold Seal NSF/ ANSI 61 compliant. In Natural (Vanilla) or Gemini Blue XLPE NSF/ ANSI 61 compliant from 40 gallons up.
- Linear polyethylene (LDPE) construction. Polypropylene (PPL), XLPE and PVDF available - Superior chemical resistance for acids, caustics, sodium hypochlorite, biocides, etc. Handles aggressive applications that stainless steel will not.
- Durable dual wall construction - Standard tanks rated 1.5 SPG, 1.9 SPG heavy duty available. "Tank in a Tank" design for instances where primary tank fails, the chemical will be safely contained in secondary tank.
- NEW Standard secondary tank leak detection port - for optional leak detection alarm.
- Integral pump mounting platform - Lid has 240 pound rating allowing for use with metering pump or mixer mounted directly to tank dome. Models with sump reservoir collects and drains liquid back to primary.
- Pump pick-up tube port - Install pump suction line with check valve quickly and easily. Once installed, tank contents are sealed from outside environment.
- Integral mouse door - Molded directly into most Gemini® models, recessed mouse door allows for inexpensive installation of optional bottom bulkhead fitting for flooded suction connection or bottom fill.
- Custom colors and mold-in graphics - Custom colors available, subject to minimum order quantity. Private label mold-in graphic is molded directly into tank and won't weather, crack, peel, or deteriorate.
- All of our tanks meet or exceed the EPA's requirements for secondary containment under EPA Regulation 40-CFR.
- For a wide range of Gemini® Accessories see pages 36 to 37.





Gemini Dual Containment® - Cylindrical

Tank Size Gal / Liter	Dia	Hgt	Capacity		Polyethylene LDPE † SD 1.5		Polyethylene LDPE † HD 1.9		Crosslink XLPE Natural	
			Inner	Outer	Blue	Natural	Blue	Natural	SD 1.5	HD 1.9
15 G / 57 L	19.5 in / 49.53 cm	28.75 in / 73.03 cm	15 G / 57 L	25 G / 95 L	01-28907	01-28906	01-29772	01-29763	01-30124	01-30135
20 G / 76 L	22 in / 55.88 cm	26.75 in / 67.95 cm	20 G / 76 L	28 G / 106 L	01-14871	01-1073	01-29773	01-29764	01-30125	01-30136
40 G / 151 L	22 in / 55.88 cm	42.5 in / 107.95 cm	40 G / 151 L	51 G / 193 L	01-29436	01-29437	01-29775	01-29766	† 01-30127	† 01-30138
40 G / 151 L	23.5 in / 59.69 cm	39.5 in / 100.33 cm	40 G / 151 L	50 G / 189 L	01-14874	01-1076	01-29774	01-29765	† 01-30126	† 01-30137
62 G / 235 L	25.5 in / 64.77 cm	38 in / 96.52 cm	62 G / 235 L	74 G / 280 L	01-14877	01-1077	01-29776	01-29767	† 01-30128	† 01-30139
65 G / 246 L	27 in / 68.58 cm	47 in / 119.38 cm	65 G / 246 L	92 G / 348 L	01-29920	01-29921	01-29922	01-29923	† 01-30129	† 01-30140
90 G / 341 L	34 in / 86.36 cm	41.25 in / 104.78 cm	90 G / 341 L	116 G / 439 L	01-30294	01-30295	01-30296	01-30297	† 01-30298	† 01-30299
120 G / 454 L	33 in / 83.82 cm	47 in / 119.38 cm	120 G / 454 L	142 G / 538 L	01-14870	01-1072	01-29777	01-29768	† 01-30130	† 01-30141
160 G / 606 L	34 in / 86.36 cm	68 in / 172.72 cm	160 G / 606 L	224 G / 848 L	01-29877	01-29939	01-29940	01-29941	† 01-30131	† 01-30142
220 G / 833 L	48 in / 121.92 cm	48 in / 121.92 cm	220 G / 833 L	278 G / 1052 L	01-14872	01-1074	01-29778	01-29769	† 01-30132	† 01-30143
320 G / 1211 L	48 in / 121.92 cm	60.5 in / 153.67 cm	320 G / 1211 L	385 G / 1457 L	01-14873	01-1075	01-29779	01-29770	† 01-30133	† 01-30144
500 G / 1893 L	61 in / 154.94 cm	66.5 in / 168.91 cm	500 G / 1893 L	650 G / 2461 L	01-14876	01-14875	01-29780	01-29771	† 01-30134	† 01-30145



Gemini Dual Containment® - Square

Tank Size Gal / Liter	Length	Width	Height	Capacity		Polyethylene LDPE † SD 1.5		Polyethylene LDPE † HD 1.9		Crosslink/HDXLPE Natural	
				Inner	Outer	Blue	Natural	Blue	Natural	SD 1.5	HD 1.9
5 G / 19 L	14 in / 35.56 cm	14 in / 35.56 cm	13.5 in / 34.29 cm	5 G / 19 L	7 G / 26 L	01-31922	01-31923	01-31924	01-31925	01-31926	01-31927
10 G / 38 L	14 in / 35.56 cm	14 in / 35.56 cm	22 in / 55.88 cm	10 G / 38 L	12 G / 45 L	01-29816	01-29820	01-30044	01-30048	01-30146	01-30151
20 G / 76 L	18 in / 45.72 cm	18 in / 45.72 cm	24 in / 60.96 cm	20 G / 76 L	25 G / 95 L	01-29333	01-29371	01-30052	01-30056	01-30147	01-30152
40 G / 151 L	20 in / 50.8 cm	20 in / 50.8 cm	37.25 in / 94.62 cm	40 G / 151 L	51 G / 193 L	01-29655	01-29659	01-30060	01-30064	† 01-30148	† 01-30153
70 G / 265 L	24 in / 60.96 cm	24 in / 60.96 cm	41 in / 104.14 cm	70 G / 265 L	84 G / 318 L	01-29824	01-29828	01-30068	01-30072	† 01-30149	† 01-30154
120 G / 454 L FRP Reinforced	32 in / 81.28 cm	32 in / 81.28 cm	50 in / 127.00 cm	120 G / 454 L	167 G / 632 L	01-29671	01-29675	01-30076	01-30080	† 01-30150	† 01-30155
NEW 120 G / 454 L Ribbed	32 in / 81.28 cm	32 in / 81.28 cm	50 in / 127.00 cm	120 G / 454 L	167 G / 632 L	01-32973	01-32974	01-32975	01-32976	† 01-32978	† 01-32980
NEW 175 G / 662 L Ribbed	35 in / 88.90 cm	35 in / 88.9 cm	57 in / 144.78 cm	175 G / 662 L	240 G / 908 L	01-33086	01-33088	01-33087	01-33089	† 01-33091	† 01-33093

SD is Standard Duty
HD is Heavy Duty

Part #'s include Gemini® logo, dimensions are nominal. † NSF/ANSI 61 Compliant. XLPE have different fitting configurations - contact customer service for more information. Ribbs on Gemini® Square Ribbed tanks are not designed for use in lifting tank with a forklift.

See Page 21 for Tank Stands

Twist Lid sizes on all Tanks w/Lids.

For other materials, part numbers and pricing call customer service.

Gemini Dual Containment® - CLO2

These Gemini Dual Containment® Tanks are specially made for use with Chlorine Dioxide Solutions. All fittings and access openings are ventless so no vapors can migrate from tanks other than through the vent. All fasteners are non-metallic and access lid is gasketed.

Description	Part #
20 Gal Gemini® PVDF/inner, PE/outer, CLO2 Lid - no fittings	01-29478
40 Gal Gemini® PVDF/inner, PE/outer, CLO2 Lid - no fittings	01-29479
62 Gal Gemini® PVDF/inner, PE/outer, CLO2 Lid - no fittings	01-29480
120 Gal Gemini® PVDF/inner, PE/outer, CLO2 Lid - no fittings	01-29481
PVDF Fitting Kit (1) 3/4" and (1) 2" PVDF Half coupling installed	02-29482

* Other sizes of CLO2 tanks available and can be quoted on request.



Gemini® 20 Gallon
CLO2 Tank
Showing Optional
Fittings and Accessories



Products

Gemini® PLUS

Peabody Engineering is proud to introduce our Gemini® PLUS Double Walled Chemical process and storage tank 1300-gallon size. We have designed this tank with all the integral design features you need to make it simple and affordable to customize your tank for even the most demanding applications.



This is the FIRST tank in our new PLUS line of chemical process and storage solutions. The Gemini® PLUS 1300 is also available ASTM D-1998 rated and is available in LDPE, HDPE, XLPE, PPL or PVDF construction.

The base tank includes a large 16" OD threaded access manway, heavy-duty D-ring lifting lugs and provisions for easy attachment of standard Ladders, truck fill lines, top or bottom discharge assemblies, level and leak detection, seismic restraint packages and more. The Gemini® PLUS can be pre-fitted to your specifications at the factory or easily retro-fitted in the field.

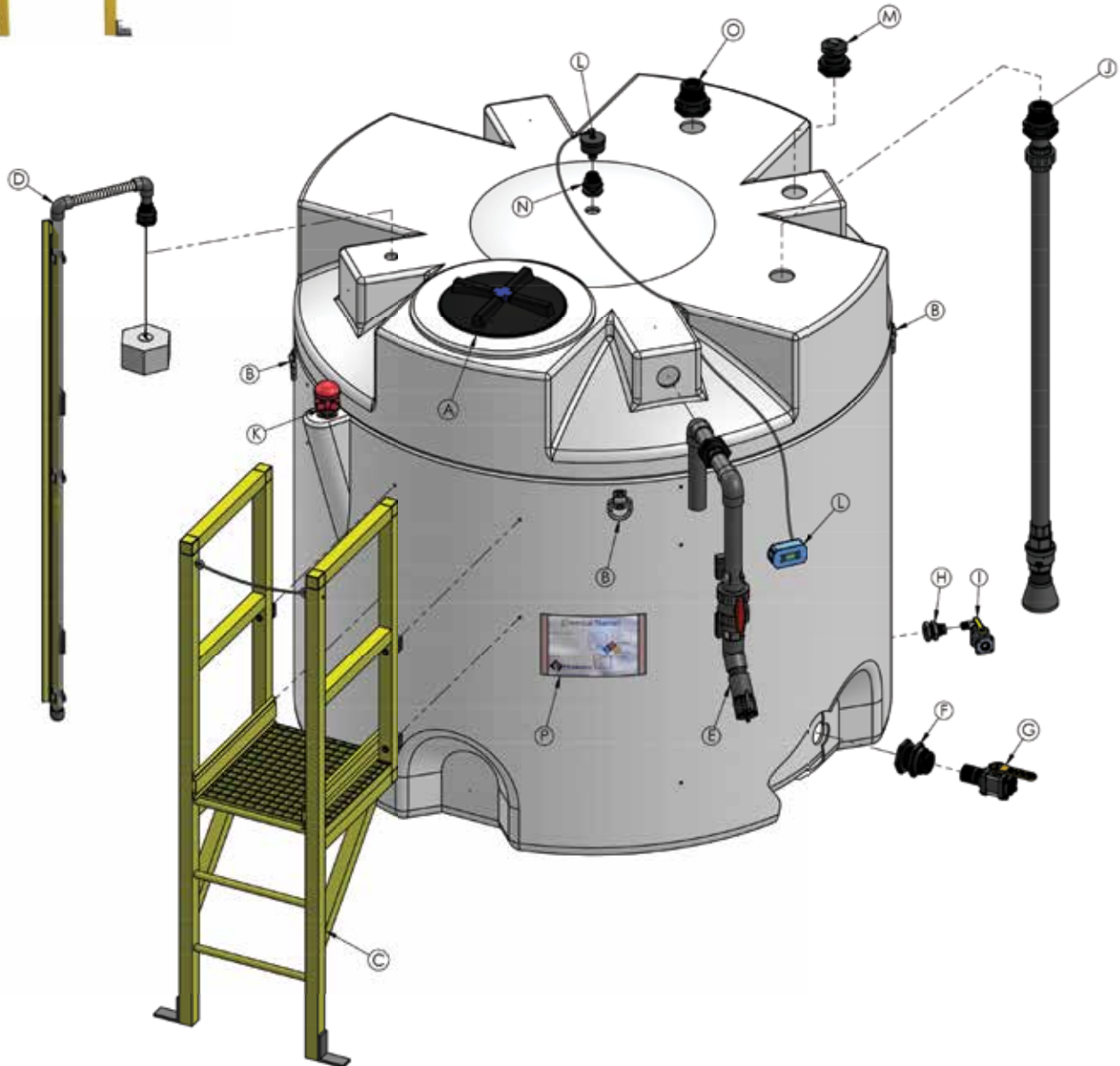

Tank Size Gal / Liter	Dia	Hgt	Capacity		Standard Natural	ASTM D-1998 Natural			XLPE Natural	XLPE ASTM D-1998 Natural	
			Inner	Outer	1.3	1.5	1.9	1.3	1.5	1.9	
1300 G 4921 L	84 in 213.36 cm	82.5 in 209.55 cm	1300 G 4921 L	1430 G 5413 L	01-33362	01-33363	01-33364	01-33365	01-33366	01-33367	

Gemini® PLUS Accessories

Item	Description	PN
A	16" ID (18" OD) Vented Twist Lid	02-133
B	(4) Lifting D-Rings	02-32866
C	FRP Ladder with 18" x 24" Landing and attachment kit.	27-32867
D	Mini-Inverse level with 4" wide calibration board.	02-32868
E	2" PVC fill line with Hayward true union PVC/EPDM ball valve, 45 degree ell, PPL male QC adaptor and dust cap with lanyard, plus attachment hardware.	02-32869
F	2" Hayward PVC double wall bulkhead primary drain outlet fitting, using (3) EPDM gaskets, installed in "Mouse Cave".	02-28853
G	2" PPL Bolted Style Full Port Compact ball valve, MPT x FPT, to be installed into double wall drain outlet.	10-32870
H	3/4" Secondary space drain outlet: 3/4" Hayward PVC/EPDM bulkhead fitting installed on lower sidewall.	02-54
I	3/4" Secondary valve drain kit: 3/4" PPL bolted style full port ball valve and 3/4" poly street ell. To be installed into secondary space drain outlet.	02-32871
J	2" Top Suction Line with Dip Tube: includes 2" PVC union, 2" PVC dip tube, 2" PVC spring check valve, 2" polyethylene suction screen.	02-32872
K	Interstitial Leak Detection System: includes Battery powered, float style sensor with audible and visual alarm. Epoxy coated enclosure, PPL float, PVC coated cable	24-32262
L	ProChem® LS-Ultrasonic Level Sensor - Model 1	24-33426
M	2" Top Extra Vent: includes 2" Norwesco PPL/EPDM bulkhead fitting and a PPL mushroom vent with poly screen	02-32873
N	1" Bulkhead Fitting PPL/EPDM	02-12
O	2" Top Auxiliary Outlet: 2" Hayward PVC/EPDM bulkhead fitting installed on top tank pedestal, location to be decided.	02-32874
P	(2) 3P Document Protectors, to be installed by customer in locations of choice	02-31945
Q	CAD submittal drawings: show all accessories on tank (not shown on drawing)	272-32875



Products

Gemini² MCU™ - Multiple Chemical Unit

STORE MULTIPLE CHEMICALS IN A SINGLE, MULTI-COMPARTMENT DUAL CONTAINMENT TANK.

Configure two, three, or four different liquids in one compact space, with 2 separate containment chambers that is as flexible as you need it to be. The new Gemini2 MCU™ (Multiple Chemical Unit) has individual primary Tanks available in 6 and 12-gallon sizes. Configure your tank with (2) 12-gallon tanks, (1) 12-gallon and (2) 6-gallon tanks or (4) 6-gallon tanks, all in one compact space. Great for Biocide/Inhibitor set-ups, Pool Chemical feed systems or any other application where you require multiple chemicals with limited space for storage.

An optional overhead PumpDeck™ can be integrally mounted to the MCU™ with room for up to 4 metering pumps. The PumpDeck™ is designed to contain pump drips or minor spills that will drain back into the correct tank and can also be equipped with an alarm that will warn you of leaks in both the shelf and/ or the interstitial space before it's a problem.

- Takes up only a 25" square footprint of space x 27" in height (excluding PumpDeck™)
- Can be configured for 2, 3, or 4 containers
- An overhead PumpDeck™ option is available
- Tank and PumpDeck™ leak detection system is available with flashing strobe and audible alarm
- An optional funnel is also available for easy filling from a pail or carboy see page_____
- Available in LDPE, HDPE, XLPE, PPL or PVDF for a wide range of chemical compatability
- Standard unit provided with a combination of blue and natural tanks for easy chemical identification; Other colors also available for each tank

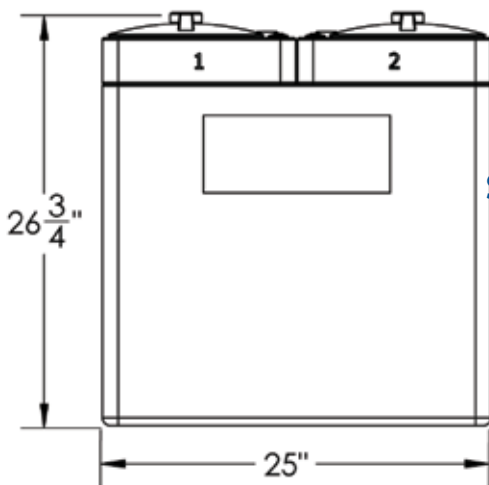

**Showing w/Optional
MCU™ PumpDeck™
PN 02-31940**

**Showing w/Optional
ProChem® Funnel
PN 02-31951**



**Assembly #2
PN 01-31896**



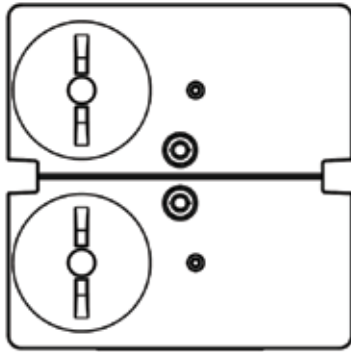

Assembly #1 PN 01-31895 | (2) 12 Gallon Tanks

Option with PumpDeck™
Without PumpDeck™

This model consists of (2) 12 Gallon Primary Tanks in Isolated Secondary Containment Chambers. Optional colors of each tank may be selected by part number below. For model with PumpDeck, add PumpDeck part number.

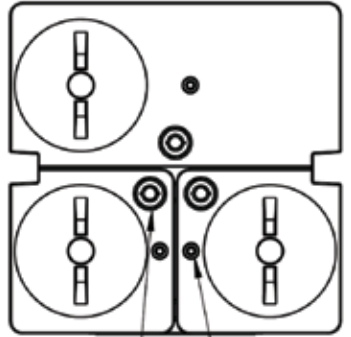

Assembly #2 PN 01-31896 | (1) 12 Gallon & (2) 6 Gallon Tanks

Option with PumpDeck™
Without PumpDeck™

This model consists of (1) 12 Gallon and (2) 6 Gallon Primary Tanks in (2) Isolated Secondary Containment Chambers. Optional colors of each tank may be selected by part number below. For model with PumpDeck, add PumpDeck part number.

SECONDARY TANK ACCESS
PUMP SUCTION CONNECTION

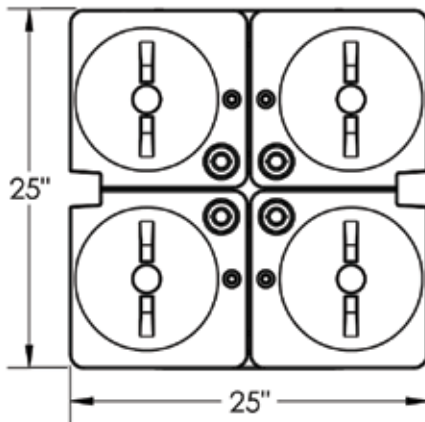

Assembly #3 PN 01-31897 | (4) 6 Gallon Tanks

Option with PumpDeck™
Without PumpDeck™

This model consists of (4) 6 Gallon Primary Tanks in (2) Isolated Secondary Containment Chambers. Optional colors of each tank may be selected by part number below. For model with PumpDeck, add PumpDeck part number.

Don't forget to order your ProChem ClamShell Funnel for easy filling of your Gemini² MCU Tanks.

Individual MCU Tank and Component Part Numbers

Individual MCU Tank and Component Part Numbers				
Item	Blue	Natural	Dia x Hgt	Wt (lbs)
MCU Outer Containment Tank	01-31894	01-31901	25" x 25" x 22"	38
MCU 12 Gallon Primary Tank	01-31891	01-31898	12.5" x 6.25" x 24"	14
MCU 6 Gallon Primary Tank Left	01-31892	01-31899	6.25" x 6.25" x 24"	7
MCU 6 Gallon Primary Tank Right	01-31893	01-31900	6.25" x 6.25" x 24"	7

Optional Accessories

Item	Color	Wt (lbs)	Part #
MCU PumpDeck	Black	17	02-31940
MCU ClamShell 8" Funnel	Black	5	02-31951
MCU ClamShell 4" - 6" Funnel	Black	5	02-31977

Assembly #1 PN 01-31895

See Page 32
for Funnel



Products

Enclosure Products



PCS Pump Containment Enclosure

Polyethylene material allows for a wide chemical compatibility and is corrosion resistant. Cover contains pumps/meters safely inside enclosure and protects workers and environment from accidental leaks or spray from tubing or pumps. Optional Divider isolates pumps with different chemicals to allow for separate containment and minimize contamination from mixed chemicals. Built-in reservoir collects discharged liquid and drains through bottom drain port which allows for easy return to tank. Available standard in blue or natural (custom colors available by special request). Price includes (4) aluminum brackets for wall or deck mounting. Custom company graphics can be added for increased brand awareness. Optional security bolt prevents unauthorized access to contents.

Additional Details

- Integral sidewall openings for suction, discharge and electrical connections.
- 3 Models available to comfortably fit 1, 2 or 3 pumps with enough room to service and adjust pumps as needed.
- Room for optional pump controller.
- Molded-in mounting holes or brackets for secure mounting and centering to walls, studs or any level surface.
- Modular design allows for mounting shelves in series for multi-pump installations.
- Strong enclosure with a 240 pound load rating.

Description	L	W	H	Holds Pumps	Blue	Natural
1 Pump Enclosure - w/Cover	15 in / 38.1 cm	18.25 in / 46.36 cm	22.50 in / 57.15 cm	1	253-31187	253-31180
2.1 Pump Enclosure - w/Cover - w/Divider	22 in / 55.88 cm	18.5 in / 46.99 cm	22 in / 55.88 cm	2	253-29867	253-29870
2.1 Pump Enclosure - w/Cover - No Divider	22 in / 55.88 cm	18.5 in / 46.99 cm	22 in / 55.88 cm	2	253-30834	253-30835
3 Pump Enclosure - w/Cover - w/Divider	35 in / 88.9 cm	23 in / 58.42 cm	28 in / 71.12 cm	3	253-29460	253-29458
3 Pump Enclosure - w/Cover - No Divider	35 in / 88.9 cm	23 in / 58.42 cm	28 in / 71.12 cm	3	253-30843	253-30844

Pump Containment Enclosure - Optional Accessories

Description	Installed	PCS1	PCS2.1	PCS3
FRP Stands for Pump Containment Enclosures		253-31442	253-31441	253-31440
Pump Controller Mounting Pad Kit (Black Polyethylene)	Yes		02-30159	02-30158
Weather Strip Gasket Seal for PCS (Shipped Loose)	No		02-30156	02-30157
Pump Enclosure Security Fastener Kit for PCS2.1 or PCS3			253-30924	253-30925
Pump Enclosure Security Bolt			253-30922	253-30922
Pump Enclosure Security Bolt Tool			253-30923	253-30923



FRP Stand PN 253-31440



Pump Turtle

The Pump Turtle™ is a pump containment enclosure designed to keep your products safe and secure in field or in-plant chemical applications. This cost-effective enclosure holds a single chemical metering pump and is constructed of UV stabilized and chemical-resistant linear polyethylene for longevity in harsh chemical and weather environments.

Description	L x W x H	Green
Pump Turtle - 1 Pump Enclosure	18.75" x 18" x 19"	253-31434



NEW PCS-PLUS Pump Containment Enclosure

Introducing the Exciting **NEW** PCS-PLUS Pump Containment Enclosures PCS-PLUS 2 now available. PCS-PLUS 4 coming in 2020. The Ultimate enclosures for chemical feed pumps. Feature Rich, innovative and VERY user friendly.

PLUS you can use them for:

- Peristaltic (tubing) Pumps
- Small to medium positive displacement pumps
- AODD Pumps
- Small Centrifugals

Our PCS-PLUS Pump Containment Enclosures are available in our standard colors of Natural (Vanilla), Gray or Gemini Blue/Gray 2-Tone but can also be molded in custom colors for special applications or provided with your company graphics molded in for branding and enhanced market exposure. Call our customer service department for pricing on custom colors or graphics. LDPE Construction.

Features:

- Front opening doors for easy access to pumps
- Hinged top hood for ease in servicing internal equipment
- Bottom Suction port for vertical insertion of tubing into your feed pumps
- Bottom Port for Electrical Connections
- Integral Hinge design with all non-metallic corrosion-resistant components
- Dual Pane Viewing Windows for easy visual assessment of pumps inside
- Integral Anchoring Connections
- Lockable front doors to secure your equipment from unauthorized access
- Integral Mounting Supports for Coupon Racks and Piping Manifolds
- Standard mounting plate for installation of your pump controller inside
- Enhanced bottom sump drain connection
- Optional Internal Cooling Fan



PCS-PLUS 2.0

Description	Internal Dimensions			External Dimensions			Blue/Gray 2-Tone	Natural	Gray
	L	W	H	L	W	H			
PCS-PLUS 2 No Divider	20 in	20 in	30 in	29 in	26 in	38 in	253-33297	253-33304	253-33827
PCS-PLUS 2 w/Divider	20 in	20 in	30 in	29 in	26 in	38 in	253-33298	253-33305	253-33828
PCS-PLUS 2 Base Only No Divider	20 in	20 in	25 in	28 in	25 in	31 in	253-33299	253-33306	253-33829
PCS-PLUS 2 Base Only w/Divider	20 in	20 in	25 in	28 in	25 in	31 in	253-33300	253-33307	253-33830

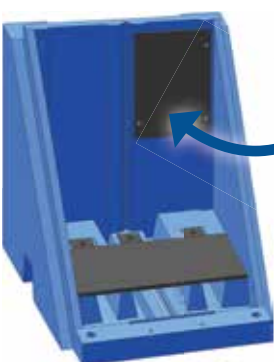

Showing Optional Controller Plate Small PN 02-33823

PCS-PLUS 2 Base Only No Divider PN 02-33299

PCS-PLUS - Optional Accessories	Installed	PCS-PLUS 2
Controller Plate Small (Black LDPE)	Yes	02-33823
Controller Plate Large (Black LDPE) (Cannot be used with PCS-PLUS with Divider)	Yes	02-33824
Ventilation Fan with 120/240V Plug	No	02-33825
Ventilation Fan with 120/240V Plug	Yes	02-33826

PCS-PLUS 4 Coming 2020

4 Pump unit has 66 Gallon Spill Containment. Holds up to (2) 55 Gallon Tanks or Drums, Forkliftable and rated for 2,500 pound loading.



Internal Dimensions			External Dimensions		
L	W	H	L	W	H
24 in	50 in	48 in	32 in	55 in	68 in



Products

NEW PCS-PRO

Fiberglass Pump and Equipment Enclosures

We are pleased to offer our **NEW** line of **PCS-PRO** fiberglass enclosures.

PCS-PRO fiberglass pump and equipment containment enclosure systems come in (4) standard sizes, but you can order custom sizes as well, by simply adding inches to any of our standard model's dimensions.

Use the **PCS-PRO** enclosures for larger chemfeed pumps, peristaltic pumps, double air diaphragm pumps, multiple pumps, or other process equipment in one enclosure.

Standard Features:

- Front opening doors with clear windows
- (2) 2" FPT outlets on each side for piping and electrical connections
- 1" Bottom sump drain outlet with PVC plug
- Integral containment sump with grate shelf for easy pump mounting
- Integral bottom external skids to elevate enclosure off the floor or a shelf
- Std. color is gray, but other colors are available on request
- Polyester fiberglass construction
- Locking doors
- CAD submittal drawings



Description	Dimensions (L x W x H)	# of Doors	PN
PCS-PRO 1	24" x 24" x 24"	1	253-33381
PCS-PRO 2	30" x 24" x 24"	2	253-33382
PCS-PRO 3	36" x 24" x 24"	2	253-33383
PCS-PRO 4	36" x 30" x 30"	2	253-33384

Options:

- Custom colors
- Molded-in company logos
- Vinyl ester fiberglass construction for more aggressive chemicals
- External mounting brackets for mounting from any side
- Integral legs to elevate enclosure to desired height
- Extra doors on sides or top
- Extra windows on sides or top
- Internal mounting brackets for coupon racks, piping, controllers, etc.
- Venting
- Lifting lugs
- Forklift slots





Aquarius Tapered Chemical Feed Tanks

Tapered and Nestable to save you money on shipping and storage. These PE chemical feed tanks have a 22° mixer mounting surface and 100# rated pump surface with recessed collection reservoir. 4" inspection port, and (2) 2" FNPT fittings. Perfect for the water treatment industry. Available in custom colors and molded-in company graphics available upon request and by special order. Tank available standard in blue or natural. Molded in LDPE. XLPE available at additional cost Optional Hinged Lid available and can be quoted on request.

Description	Dia x H	Blue	Natural
30 Gal Aquarius Tank 3/16" Wall	27" x 21.5"	01-28643	01-28641
30 Gal Aquarius Tank HD 5/16" Wall	27" x 21.5"	01-28647	01-28645
55 Gal Aquarius Tank 3/16" Wall	27" x 35.5"	01-28651	01-28649
55 Gal Aquarius Tank HD 5/16" Wall	27" x 35.5"	01-28655	01-28653



Closed Top Rectangular Tanks

Great for Auto Detail/Graffiti Removal Tank and tanks for use with Heavy Equipment

Closed Top Rectangular Tanks are designed to fit into the back of trucks, vans and cars. Tanks can be used in any position. Do NOT use for fuel storage. Tie Down Straps (Ratchet Straps) can be purchased at local hardware stores. All of the tanks, except the 330 gallon, can be rotated to any position, so any side can be the top. Molded in LDPE construction. Also used by Pest Control Operators (PCO). Twist Lid included.

Description	Lid Size	L x W x H	Part #
13 Gallon Closed Top Rectangular NEW	8"	11.5" x 27" x 11.5"	01-33376
20 Gallon Closed Top Rectangular NEW	8"	12" x 37" x 12"	01-33377
23 Gallon Closed Top Rectangular NEW	8"	20.5" x 18.5" x 15.5"	01-33378
27 Gallon Closed Top Rectangular NEW	8"	24" x 24" x 12"	01-32748
28 Gallon Closed Top Rectangular NEW	8"	24" x 24.5" x 12"	01-33379
42 Gallon Closed Top Rectangular	8"	36.75" x 25" x 12"	01-28949
330 Gallon Closed Top Rectangular	8"	50" x 43" x 43.25"	01-30437

* 16" Lid available at additional cost. See page 34 for more options.



Gemini® Pump Pup™ Pump Pedestal

Designed to securely elevate your chemical metering pump on top of your Gemini® or other chem-feed tank to make it easier to connect your suction tubing. Each Pump Pup is supplied with 8" each of 1/4" OD and 3/8" OD Poly Tubing for quick and easy connection to your Gemini® Suction Tube Assembly*.

Description	Part #
Gemini® Pump Pup™ Pump Pedestal Kit	02-32865

Products



Cone Bottom Tanks - TD Series

Cone bottom open top tanks have a 60° slope at the cone bottom. Available standard in natural polyethylene. TD Series Cone Bottom Tanks are solid/closed top and they do not come with fittings, but they may be installed at additional cost. Available in LDPE or XLPE.

PPL and PVDF tanks also available.
See Tank Lid section for optional lid choices.
See Tank Stands section for optional stand choices

Cone Bottom Tanks - TD Series

Description	Dia x Ht x Shell	Bottom Slope (°)	Wall Thk	LDPE Natural	XLPE Natural
				Part #	Part #
19 Gal Cone Bottom Tank ~	16.5" x 30" x 18"	60	1/4"	01-1240	01-32934
25 Gal Cone Bottom Tank ~	18.25" x 32" x 18"	60	1/4"	01-1247	01-32935
40 Gal Cone Bottom Tank ~	23.25" x 37.25" x 18"	60	1/4"	01-1259	01-32936
40 Gal Cone Bottom Tank - Tall	20.75" x 40" x 24"	60	1/4"	01-1261	01-32937
98 Gal Cone Bottom Tank	33.25" x 44.75" x 18"	60	1/4"	01-1278	01-32938
101 Gal Cone Bottom Tank	24.5" x 67.75" x 48.25"	60	1/4"	01-1228	01-32939

~ Indicates item may ship UPS Oversize.

* Bolted cover comes with PVC bolts, and PVC gasket

Stands for Cone Bottom Tanks - TD Series

Stands are available in mild steel or stainless steel. Stands are built to exact tank specifications to ensure a secure holding of your tank. Stand raises tank off of ground to allow for bottom draining and connection hook up. Feet have bolt holes to allow tank stand to be bolted into place for added stability. Stands are available with or without agitator bracket. 18" (nom.) bottom clearance.



Description	Without Agitator Bracket		With Agitator Bracket	
	Painted Mild Steel	Stainless Steel	Painted Mild Steel	Stainless Steel
	Part #	Part #	Part #	Part #
19 Gal Cone Bottom Tank Stand	02-27291	02-31044	02-31050	02-31056
25 Gal Cone Bottom Tank Stand	02-27292	02-31045	02-31051	02-31057
40 Gal Cone Bottom Tank Stand	02-27294	02-31046	02-31052	02-31058
40 Gal Cone Bottom Tank Stand - Tall	02-27293	02-31047	02-31053	02-31059
98 Gal Cone Bottom Tank Stand	02-27296	02-31048	02-31054	02-31060
101 Gal Cone Bottom Tank Stand	02-27295	02-31049	02-31055	02-31061



NEW Forkliftable Tank Stand

Peabody also offers stands for tanks that are provided with forklift slots for ease in moving your tanks from place to place. All coated steel construction and secure mounting brackets hold your tank secure for safe movement using best practices in forklift safety. Stainless Steel Stands are also available.

Note: Forklift stands for tanks up to 320 gallons.

Table needs to list weight capacity and warning to only move tanks at low speed



Description	Fits Tank Sizes	L	W	Wt Capacity	Part #
Forkliftable Tank Stand	5 - 65 gallon	24 in / 60.96 cm	24 in / 60.96 cm	1100 Lbs / 499 Kg	02-33373
Forkliftable Tank Stand	75 - 200 gallon	36 in / 91.44 cm	36 in / 91.44 cm	3200 Lbs / 1451 Kg	02-33374
Forkliftable Tank Stand	220 - 320 gallon	48 in / 121.92 cm	48 in / 121.92 cm	4800 Lbs / 2177 Kg	02-33375



ProChem® Tank Stacker™

The ProChem® Tank Stacker™ (Pat. Pending) is designed for tank installations where space is limited. Stack any combination of (2) of the following tanks: G10², G20², G15 or G20, as well as our ProChem® Open Top Process Chemical Tanks from 5 to 30-gallon sizes, or Pump Containment Enclosure, one over the other.

Description	L x W x H	Dark Grey
ProChem® Tank Stacker	30" x 30" x 46.25	02-30348

Products

ProChem® Cone Bottom Tanks

ProChem® Cone Bottomed Tanks are designed for storage of water or chemical solutions where, batching, mixing or full drainage might be required. Tank basins are sloped at 30° or more for optimum mixing and good drainage, reducing solids accumulation at bottom of tank.

Available in Standard Duty for liquids up to 1.5 Specific Gravity (12 ½#/gal.) or Heavy Duty for liquids up to 1.9 Specific Gravity (16#/gal.). Designed for atmospheric pressure and ambient temperature applications. Large 16" vented twist lid is standard. Drain and process fittings are not included but available in various sizes and styles. Stands are available in standard and seismic rated designs. Contact customer service for application assistance.

ProChem® Cone Bottom Tanks			LDPE 1.5	LDPE 1.9	XLPE
Size	Dia x Ht	Bottom Slope (°)	Part #	Part #	Part #
200 Gallon	34 x 63	30	01-31214	01-31225	01-33859
500 Gallon	48 x 81	30	01-31217	01-31228	01-33863

ProChem® Cone Bottom Tanks are also available in FDA Potable, PPL and PVDF (Kynar®)

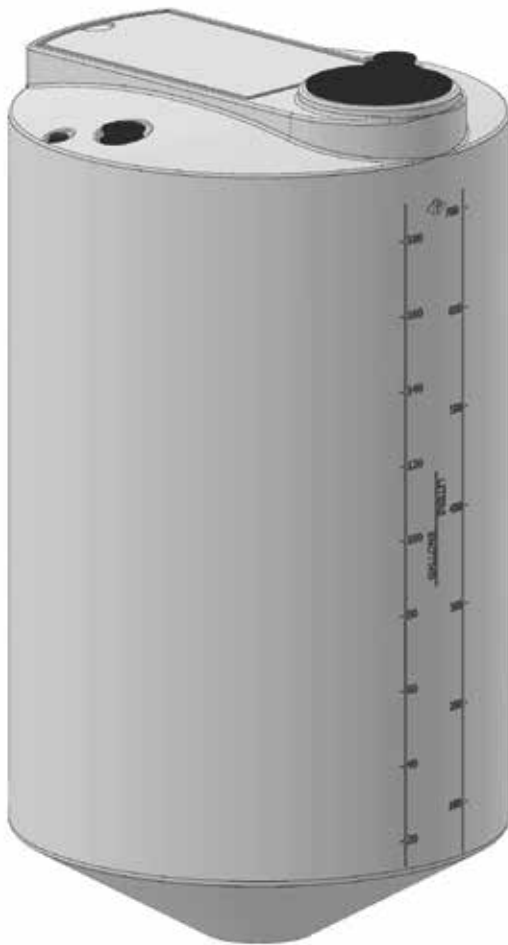

Size: 200 Gallon

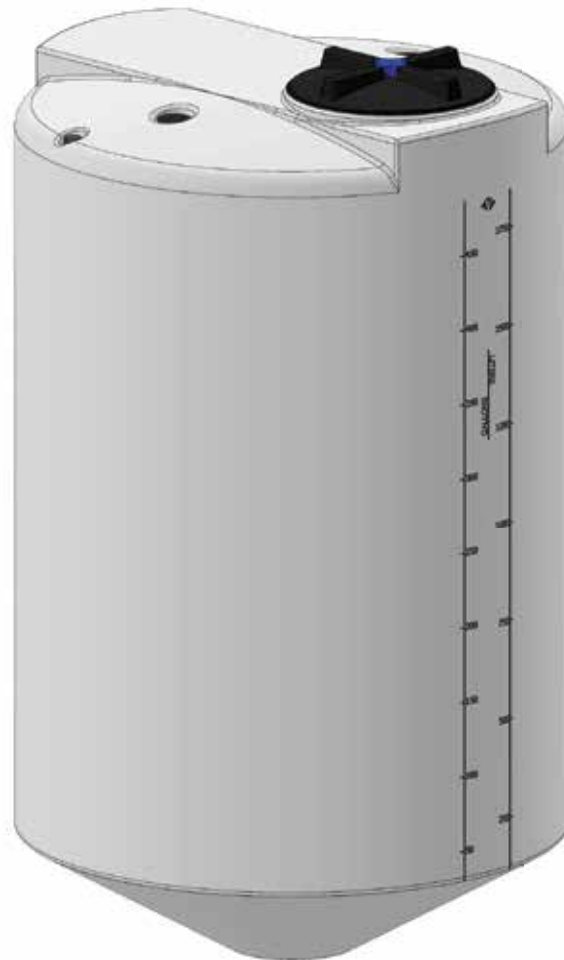

Size: 500 Gallon



ProChem® Cone Bottom Tank Stands

ProChem® Cone Bottom Tank Stands are made with Stainless Steel Material and they are designed to fit our ProChem® Cone Bottom Tanks. Stands are available in standard and seismic rated designs. Contact customer service for application assistance.

ProChem® Cone Bottom Tank Stands		Steel
Size	Dia x Ht	Part #
200 Gallon	45 x 26	02-33867
500 Gallon	49 x 34	02-33868

Size: 200 Gallon

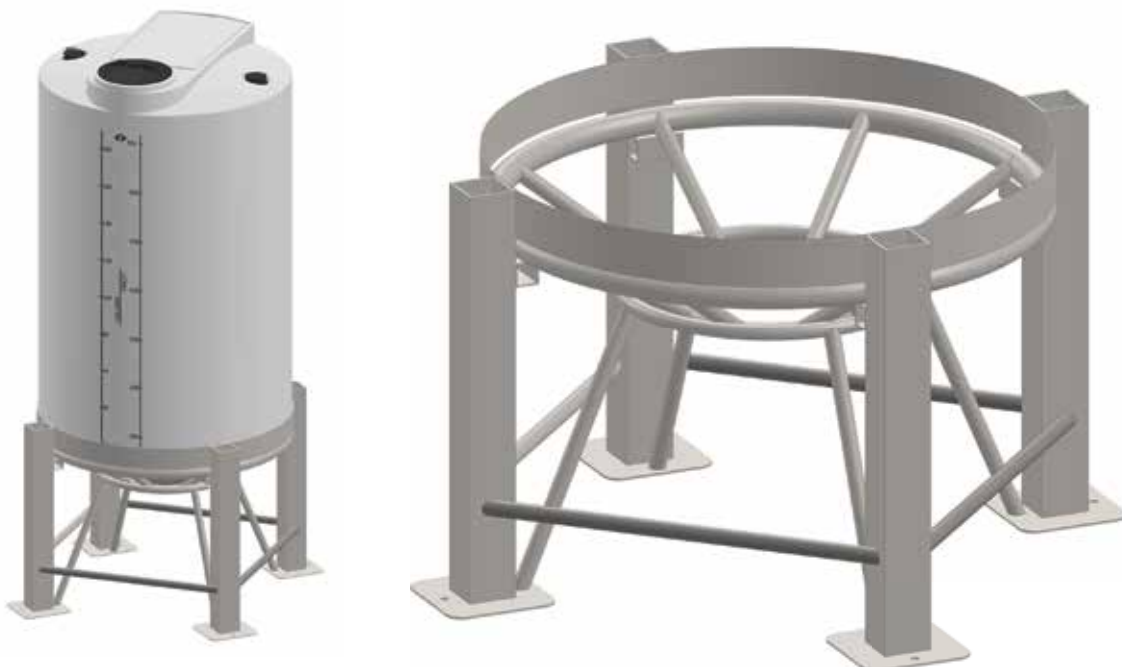

Size: 500 Gallon



Products

Containment Products



Gemini® ChemFeed™ Bin

Gemini® ChemFeed™ Bin is designed to safely contain your single-walled process tank and provide an integral mounting surface for Chemical Feed pumps or other equipment. The Gemini® ChemFeed™ Bin can accommodate tanks from 5 to 80-gallon sizes and up to four (4) metering pumps. Exceeds EPA 40 CFR secondary containment requirements for tanks up to 200 gallons. 100% LDPE construction.



Description	Capacity	L x W x H	Part #
ChemFeed™ Bin	107	66" x 35.25" x 19.5"	02-30331

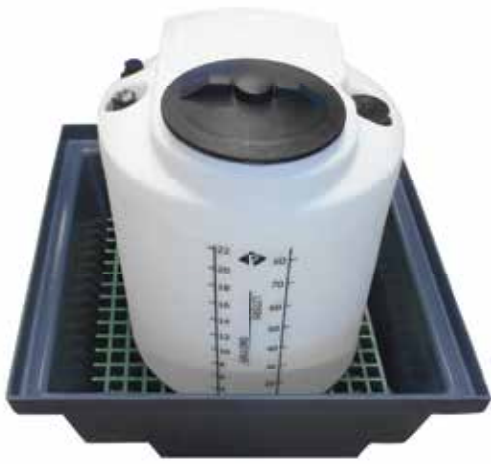

ProChem® Containment Basin

ProChem® Basins are made from LDPE. Designed to provide secondary containment per EPA 40 CFR for Tanks up to 1500 gallon capacity. Optional fiberglass (FRP) grating base available to elevate tank from basin floor.



Description	Holds Tank Size	Base L x W	Top L x W	H	Part #	FRP Grating Base Kit
ProChem® Basin - 33.5 Gallon	25	24" x 24"	31" x 31"	14"	253-31629	02-31826 +
ProChem® Basin - 66 Gallon	50	24" x 24"	34" x 34"	24"	253-31630	02-31826 *
ProChem® Basin - 67 Gallon	(2x) 25/50	24" x 48"	32" x 56"	14"	253-31631	02-31827
ProChem® Basin - 111 Gallon	65/75/100	36" x 36"	42" x 42"	20"	253-31632	02-31828 *
ProChem® Basin - 120 Gallon	(2x) 75/100	36" x 60"	42" x 66"	13"	253-31633	02-31829
ProChem® Basin - 182 Gallon	125	36" x 36"	45" x 45"	30"	253-31695	02-31828 *
ProChem® Basin - 220 Gallon	175/200	40" x 40"	49" x 49"	30"	253-31634	02-31830 *
ProChem® Basin - 400 Gallon	290/300	54" x 54"	62" x 62"	32"	253-31635	02-31831 *
NEW ProChem® Basin - 825 Gallon	525 & 750	60" x 60"	71" x 71"	50"	253-33343	02-33346
NEW ProChem® Basin - 1100 Gallon	1000	84.5" x 84.5"	89" x 89"	42"	253-33344	02-33347
NEW ProChem® Basin - 1650 Gallon	1500	84.5" x 84.5"	90" x 90"	61"	253-33345	02-33347

+ Grating Only

*Kit includes additional grating supports as necessary- All Non-Metallic



Peabody Engineering

NEW Stands for ProChem® and Gemini® Tanks

Peabody offers standard 24" Tall Coated Steel Stands for all of our tanks. Stands are designed to be used independently or **can be placed inside our ProChem® Containment Basins** for responsible containment to protect against leaks and spills.

- Mixer mounting brackets
- Add shelves
- Taller stands
- Seismically compliant
- Custom sizes for multiple tanks or for adding other equipment, like pumps next to tanks
- St. steel construction
- Round stands
- Aluminum construction
- Fiberglass construction



21" x 21" x 24"		PN 02-33368
Fits up to 20" Dia Tank		
Basin Size: 33.5G or 66G		
For use with the following Tanks	Capacity (Gal)	Tank Size
Open Top	5	12
Gemini2 Dual Containment®	5	14
Open Top	10	12
Gemini2 Dual Containment®	10	14
Open Top	10	15
Open Top	15	15
Gemini2 Dual Containment®	20	18
ProChem®	25	19.5
Open Top	30	18
ProChem®	50	19.5

27" x 27" x 24"		PN 02-33369
Fits up to 24" Dia Tank		
Basin Size: 111G		
For use with the following Tanks	Capacity (Gal)	Tank Size
Gemini Dual Containment®	15	19.5
Gemini Dual Containment®	20	22
ProChem®	25	19.5
Gemini2 Dual Containment®	40	20
Gemini Dual Containment®	40	22
Gemini Dual Containment®	40	23.5
ProChem®	50	19.5
Open Top	55	24
ProChem®	65	23
Gemini2 Dual Containment®	70	24

39" x 39" x 24"		PN 02-33370
Fits up to 36" Dia Tank		
Basin Size: 400G		
For use with the following Tanks	Capacity (Gal)	Tank Size
Gemini2 MCU	24	25
Aquarius	30	27
Aquarius	30	27
Aquarius	55	27
Aquarius	55	27
Gemini Dual Containment®	62	25.5
Gemini Dual Containment®	65	27
ProChem®	75	27
Gemini Dual Containment®	90	34
ProChem®	100	27
Open Top	100	30
Gemini2 Dual Containment®	120	30
Gemini Dual Containment®	120	33
ProChem®	125	27
Open Top	150	30
Gemini Dual Containment®	160	34
ProChem®	175	34
ProChem®	200	34
Open Top	200	34
Gemini2 Dual Containment®	175	35

51" x 51" x 24"		PN 02-33371
Fits up to 48" Dia Tank		
Basin Size: 825G		
For use with the following Tanks	Capacity (Gal)	Tank Size
Gemini Dual Containment®	220	48
ProChem®	300	48
Open Top	300	48
Gemini Dual Containment®	320	48
Open Top	400	48
Open Top	500	48
ProChem®	525	48
ProChem®	525	48
ProChem®	750	48

76" x 76" x 24"		PN 02-33372
Fits up to 74" Dia Tank		
Basin Size: 1650G		
For use with the following Tanks	Capacity (Gal)	Tank Size
Gemini Dual Containment®	500	61
ProChem®	1000	74
ProChem®	1500	74



Products

ProChem® PailVault™

Protect your chemicals in 5-gallon pails from costly and harmful spills with Peabody Engineering's ProChem® PailVault™, a modular chemical resistant containment enclosure that exceeds EPA's 40CFR regulations on secondary containment requirements. The PailVault's rotationally molded linear polyethylene construction provides a durable enclosure that keeps your chemicals safe and secure from chemical spills, which can cause workplace injuries and costly environmental clean-up.

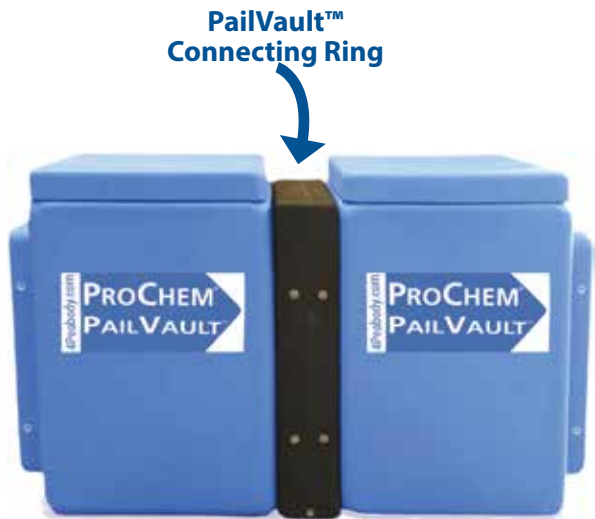

Description	Blue PN	Natural PN
ProChem® PailVault™ - Standard	253-31946	253-32013
ProChem® PailVault™ - Deluxe*	253-32292	253-32293



- Rugged Chemical-Resistant LDPE Construction for years of trouble-free service (Other materials available)
- Modular design allows for multiple units of safe, isolated containment enclosures
- Over 120% containment in each module for safe, EPA-compliant storage of 30 gallons
- UV and weather-resistant for long service life in direct sunlight and outdoor exposure
- Integral pump suction port connection available
- Optional Rigid suction tube with foot valve and tubing connection
- Each unit fits (1) 5-gallon pail, JeriCan or other small container
- Locking cover option with tamper-proof security screws
- Lightweight - Only weighs 12 lbs - easily handled by one person
- Compact Design - Measures 20" x 13.75" x 24" - fits in tight spaces
- Rated for temperatures up to 140 degrees F
- Can be bolted to floor or other flat surface
- Optional Leak-detection alarm
- Available in choice of colors
- Custom Company Logos available



Optional Accessories

Description	Part #
PailVault™ Connecting Ring Black w/Hardware	02-32001
PailVault™ Suction Portal	02-32002
PailVault™ Pump Suction Tube Ass'y	02-31948
PailVault™ Cover Locking Kit	02-32003
PailVault™ Anchor Clip Hold Down Kit	02-32359



NEW ProChem® PailVault™ PLUS

PailVault™ PLUS allows operators the option of securing their metering pump to one side of the removable cover while having the convenience of removing the other half to exchange their 5-gallon Jerican-style pails without disturbing the mounted pump. This option is available in a complete unit by ordering a PailVault™ PLUS or you can buy the PLUS Lid only for use on PailVaults you already have in the field. Available in standard colors of Blue or Natural. Special Colors available on request. Ordering information is available below. LDPE Construction.

- NEW "PLUS" split lid design for ProChem® PailVault™
- Mount metering pump on fixed lid
- Large side removable for ease in changing out pails
- Rugged, sturdy design
- "Handshake" design secures lid in place

Description	Blue PN	Natural PN
PailVault™ PLUS w/Lid	253-32861	253-32862
PailVault™ PLUS Lid Only	253-32863	253-32864

Description	Blue PN
PailVault™ Connecting Ring Black	02-32001

**PailVault™ PLUS Lid Only
PN 253-32863**



**PailVault™ PLUS w/Lid
PN 253-32861**

Includes (3) Tubing Seal Fittings and (1) 3P Doc Protector



"Handshake" Design



**Pump Mounted on Lid
(Pump not included)**



Easily place 5-gallon Jerican-style pails (Pump and Jerican not included)

Products

Float Gauges for Gemini® Tanks

All Gemini® Float Style Level Gauges have 2" Male Threads for easy installation into Gemini FPT top connections. Available in your choice of Stainless Steel or PVDF for more aggressive chemical applications. Float Gauges are great for monitoring liquid levels on Dual Wall Tanks since you can't see the level through the sidewall as you can in Single Walled Tanks.

Gemini® Cylindrical Tank Size	Wt (lbs)	SST/PE - 2" NPT	SST/PE - 3/4"/1" NPT	PVDF - 2" NPT	PVDF - 3/4"/1" NPT
Gemini® 15	1	02-1083	02-32750	02-1082	02-32761
Gemini® 20	1	02-1085	02-32751	02-1084	02-32762
Gemini® 40 (Dome & Flat)	1	02-1089	02-32752	02-1088	02-32763
Gemini® 62	1	02-1093	02-32753	02-1092	02-32764
Gemini® 65	1	02-30790	02-32754	02-30792	02-32765
Gemini® 90	1	02-30791	02-32755	02-30793	02-32766
Gemini® 120	1	02-1081	02-32756	02-1080	02-32767
Gemini® 160	1	02-29965	02-32757	02-29966	02-32768
Gemini® 220	1	02-25760	02-32758	02-26532	02-32769
Gemini® 320	1	02-25761	02-32759	02-26533	02-32770
Gemini® 500	1	02-25762	02-32760	02-26534	02-32771

Gemini® Square Tank Size	Wt (lbs)	SST/PE - 2" NPT	SST/PE - 3/4"/1" NPT	PVDF - 2" NPT	PVDF - 3/4"/1" NPT
Gemini® ² 10	1	02-29967	02-32772	02-29968	02-32777
Gemini® ² 20	1	02-29790	02-32773	02-29789	02-32778
Gemini® ² 40	1	02-29969	02-32774	02-29970	02-32779
Gemini® ² 70	1	02-29971	02-32775	02-29972	02-32780
Gemini® ² 120	1	02-30794	02-32776	02-30795	02-32781
NEW Gemini® ² 175	1	02-33358	02-33359	02-33360	02-33361



Gemini® Mini-Inverse Float Level Indication Systems

NEW Mini-Inverse Float Level Indication System is designed specifically for tanks, up to 1500 gallons. It can be ordered installed on your tank or as a kit that is very easy to install on existing tanks.

- The kit includes the complete assembly, plus a hot melt glue gun and glue sticks to attach the unit to the side of your tank
- It comes standard with an easy to read fiberglass calibration board in inches that can be easily sized to your tank height
- For an added fee we will make you a tank gauge in gallons for your specific tank configuration
- The wetted components are all plastic with a fluorocarbon cable and a polyethylene float, making it compatible with any fluid your tank is compatible with
- Every kit will come with a simple laminated chart that tells how many gallons per inch based on tank dia. of Peabody Tanks
- If your tank has a different dimension, we can provide custom calibration charts for a nominal additional charge

Description	Part #
*Mini Inverse Level Gauge Kit - (Up to 60" Tanks)	02-32019
*Mini Inverse Level Gauge Kit - (Over 60" Tanks)	02-33336
Glue Gun Kit for Inverse Level Gauge	02-32020
*Mini Inverse Level Gauge Mounted On Tank Up To 1500 Gallons	02-32212
~Custom Calibrated Tank Gauge in Gallons	02-32213

*Laminated calibration chart comes standard for all Peabody tank sizes.

~Custom laminated calibration charts available per above.



Products

ProChem® LS - Ultrasonic Level Sensor and Control System

ProChem® LS - Ultrasonic is a New ultrasonic level indication and control system that provides accurate and reliable “non-contact” measurement of a wide range of fluids, including water, wastewater, chemicals, food products and petroleum products.

Description	Range	Thd Size	Part #
Model 1	6" - 78"	1"	24-33426
Model 2	12" - 120"	2"	24-33427
<i>Coming 2020</i>			

Individual Components	Part #
Level Display Unit	24-32822
Level Transmitter	24-32823
Cable, Display to Power/4-20mA Output	24-32825
Bracket - Display Mounting	24-32826

Model 1



Features

- Compact and user friendly
- 1" MPT connection, easy installation
- PTFE sensor head is chemically resistant to most fluids
- 0 to 240 degrees F temperature range
- Microprocessor-based electronic digital display in US Gallons, Imperial Gallons or Liters
- Backlit display easy to read clearly, in low light or direct sunlight
- Dual powered; wireless battery or 120 VAC powered options
- 4-20 mA signal output for integration into controllers or SCADA systems
- Selectable menu-driven software pre-programmed for all Peabody tanks for automatic calibration in seconds
- Simple to custom calibrate other tank sizes and provide up to 1% of scale accuracy
- Good for tanks up to 78" tall with only a 6" dead band
- Beam Angle is 7°±2

Additional Benefits

- Can be used in local display mode only with “no” external power operating on (2) 9v lithium batteries, that will last up to 2 years
- Supplied with 24 VDC/120 VAC power adaptor for 4-20 mA functionality
- Display can be mounted directly to the sensor or detached and located remotely up to 1000 feet away with power cable
- Display also monitors liquid temperature, time/date and battery strength
- Built in alarm setting for “high” and “low” settings



Level & Leak Detection Products

ProChem® level control and leak detection products can be used on any of our tank systems, to make your process and storage tanks even more intuitive and safer than ever before.

Level Indication and Control

Whether you need simple point level indication or multi-level control, we can provide just sensors or a complete system with a controller to fit your application perfectly.

A variety of sensor technologies and a highly chemical resistant thermoplastic construction provides a viable solution for just about any chemical environment.

Available in 110 VAC or 24 VDC.

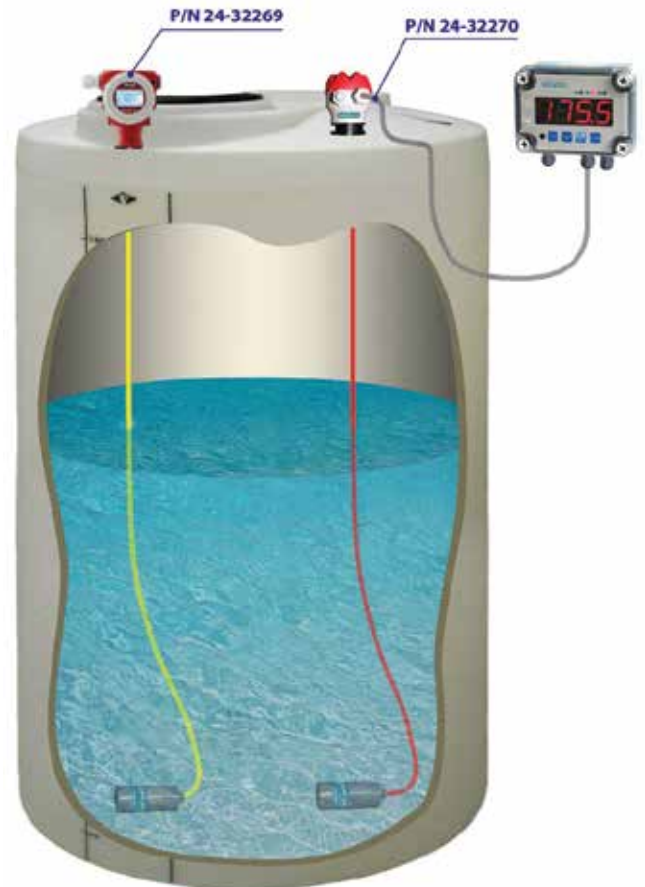

Level Description	Part #
ProChem® Continuous Tank Level Controller w/ Local LED Display - Pressure Sensing Technology, 1 Relay, 4-20 mA output, 24 VDC w/2" MPT Connection, PVC/Ceramic Teflon Wetted Parts.	24-32269
ProChem® Continuous Tank Level Controller w/ NEMA 4X Junction Box & Remote LED Display - Pressure Sensing Technology, 1 Relay, 4-20 mA output, 24 VDC w/2" MPT Connection, PVC/Ceramic Teflon Wetted Parts.	24-32270
120VAC to 24VDC power supply.	24-33858

*Stainless Steel models available on request. Call for pricing.

Products

Leak Detection

Now you can add leak detection sensors to your double walled tanks, single walled tanks, in basins or in containment areas.

We have a variety of models to choose from so you can pick the product that best suits your application.

Choose a simple "signal out" sensor or a complete control system with alerts. We have 110 VAC systems, 12VDC systems and long-lasting battery-operated systems for remote leak detection monitoring where no power source is available near your tanks.

Durable thermoplastic construction provides lots of choices for almost any chemical application.



Leak Detection Description	Part #
Level-Pro Non-Contact RF Capacitance Leak Detection Sensor - Remote Lighted Audible + Visual Indication and Connecting Cable.	24-32271
Squawker Buoyancy Style 1" NPT Level Leak Detection With Alarm (not shown on tank)	24-33820



Steel Tank Dollies

Steel Dolly With Casters

Would you like to be able to move your Gemini Dual Containment® Tanks, Cylindrical or Square, or ProChem® Open Top Process Chemical Tanks around your facility? Then you need one of our Steel Dollies with Casters for easy mobility of your tanks. Our Dollies are rugged mild steel with construction with heavy duty steel casters rated to hold our tanks, even full of your heavy liquids. Just select the caster base designed for your tank size. For larger size tanks please call for pricing.



Gemini® Tank Dolly - Cylindrical

Dollies with Casters for Gemini® Cylindrical Tanks		
Description	Weight Capacity	Part #
Steel Dolly w/Casters, for 15 Gal Gemini® Tank	15 - 400	02-31593
Steel Dolly w/Casters, for 20 Gal Gemini® Tank	20 - 400	02-30730
Steel Dolly w/Casters, for 40 Gal Gemini® Tank Flat/Dome	40 - 800	02-31594
Steel Dolly w/Casters, for 62 & 65 Gal Gemini® Tank	62 & 65 - 1300	02-31595
Steel Dolly w/Casters, for 90 Gal Gemini® Tank	90 - 1800	02-31597
Steel Dolly w/Casters, for 120 Gal Gemini® Tank	120 - 2400	02-31598
Steel Dolly w/Casters, for 160 Gal Gemini® Tank	160 - 3200	02-31596
Steel Dolly w/Casters, for 220 Gal Gemini® Tank	220 - 4400	02-31515

Gemini® Tank Dolly - Square

Dollies with Casters for Gemini® Square Tanks		
Description	Weight Capacity	Part #
Steel Dolly w/Casters, for 10 Gal Gemini® Square Tank	10 - 200	02-31760
Steel Dolly w/Casters, for 20 Gal Gemini® Square Tank	20 - 400	02-31761
Steel Dolly w/Casters, for 40 Gal Gemini® Square Tank	40 - 800	02-31762
Steel Dolly w/Casters, for 70 Gal Gemini® Square Tank	70 - 1400	02-31763
Steel Dolly w/Casters, for 120 Gal Gemini® Square Tank	120 - 2400	02-31764
Steel Dolly w/Casters, for 175 Gal Gemini® Square Tank	3500	02-33340

ProChem® Tank Dolly

Dollies with Casters for ProChem® Tanks		
Description	Weight Capacity	Part #
Steel Dolly w/Casters, for 5 Gallon ProChem® Tanks	100	02-31765
Steel Dolly w/Casters, for 10 & 15 Gallon ProChem® Tanks	300	02-31766
Steel Dolly w/Casters, for 30 Gallon ProChem® Tanks	600	02-31767
Steel Dolly w/Casters, for 55 Gallon ProChem® Tanks	1600	02-31768
Steel Dolly w/Casters, for 100 Gallon ProChem® Tanks	2000	02-31769
Steel Dolly w/Casters, for 150 Gallon ProChem® Tanks	3000	02-31770
Steel Dolly w/Casters, for 200 Gallon ProChem® Tanks	4000	02-31771



Products

Seismic FiberRing

Seismic FiberRings are designed to secure Gemini Tanks and ProChem® Tanks to a concrete foundation for seismic restraint or to secure in other applications, like boats, where the tanks need to be stabilized from movement. Each FiberRing includes a pre-drilled base flange to allow bolting to a foundation or deck (bolts not included). Seismic Engineering calculations available at additional cost.



Fiberrings ordered with tanks can be supplied with a hole for bottom discharge fittings. Call for more information

For Gemini Dual Containment® Tanks

FiberRings for Cylindrical Tanks

For Gemini® Cylindrical Tanks	Non-Code PN	Code PN
Gemini® 15 Gallon	02-30122	02-32296
Gemini® 20 Gallon	02-29282	02-32297
Gemini® 40 Gallon (Flat)	02-31013	02-32298
Gemini® 40 Gallon (Dome)	02-32294	02-32299
Gemini® 62 Gallon	02-30352	02-32300
Gemini® 65 Gallon	02-30729	02-32301
Gemini® 90 Gallon	02-31014	02-32302
Gemini® 120 Gallon	02-31015	02-32303
Gemini® 160 Gallon	02-31016	02-32304
Gemini® 220 Gallon	02-31017	02-32305
Gemini® 320 Gallon	02-31018	02-32306
Gemini® 500 Gallon	02-31019	02-32307



FiberRings for Square Tanks

For Gemini® Square Tanks	Non-Code PN	Code PN
Gemini® Squared 5 Gallon	02-32295	02-32308
Gemini® Squared 10 Gallon	02-31020	02-32309
Gemini® Squared 20 Gallon	02-31021	02-32310
Gemini® Squared 40 Gallon	02-31022	02-32311
Gemini® Squared 70 Gallon	02-30420	02-32312
Gemini® Squared 120 Gallon Ribbed	02-33056	02-33057
NEW Gemini® Squared 175 Gallon Ribbed	02-33385	02-33386



FiberRings for Gemini® MCU™

MCU™	Non-Code PN	Code PN
MCU	02-32352	02-32353



For ProChem® Tank Systems FiberRings for ProChem® Tanks

	For ProChem® Tanks	Non-Code PN	Code PN
	ProChem® 25	02-32314	02-32322
	ProChem® 50	02-32315	02-32323
NEW	ProChem® 65	02-32930	02-32931
	ProChem® 75	02-32316	02-32324
	ProChem® 100	02-32317	02-32325
	ProChem® 125	02-32318	02-32326
	ProChem® 175	02-32319	02-32327
	ProChem® 200	02-32320	02-32328
NEW	ProChem® 290	02-33387	02-33388
	ProChem® 300	02-32321	02-32329
NEW	ProChem® 525	02-32932	02-32933
NEW	ProChem® 750	02-33020	02-33021
NEW	ProChem® 1000	02-33058	02-33059
NEW	ProChem® 1500	02-33060	02-33061



FiberRings for Open or Solid Top Tanks

	For Open or Solid Top Tanks	Non-Code PN	Code PN
	Open/Solid Top 5	02-32330	02-32341
	Open/Solid Top 10	02-32331	02-32342
	Open/Solid Top 15	02-32332	02-32343
	Open/Solid Top 30	02-32333	02-32344
	Open/Solid Top 55	02-32334	02-32345
	Open/Solid Top 100	02-32335	02-32346
	Open/Solid Top 150	02-32336	02-32347
	Open/Solid Top 200	02-32337	02-32348
	Open/Solid Top 300	02-32338	02-32349
	Open/Solid Top 400	02-32339	02-32350
	Open/Solid Top 500	02-32340	02-32351



⚠ WARNING

Some of the materials used in our products can expose you to Styrene from fiberglass or other chemicals. Per Proposition 65, Styrene and other chemicals are known to The State of California to cause cancer in certain cases. If you want more information about chemicals in certain products that are included on the P65 list, please contact Customer Service.

For more information go to www.P65Warnings.ca.gov



Products

ProChem® ClamShell Funnel

Transfer chemicals safely and efficiently from D.O.T. pails, Jeri cans and buckets into your Gemini® and ProChem® storage tanks with the new "ProChem® ClamShell Funnel".

Item	Color	Fits Lid	Part #
ProChem® ClamShell Funnel for Drums	Black	2"	02-32819
ProChem® ClamShell Funnel for IBC's	Black	4" - 6"	02-31977
ProChem® ClamShell Funnel for Tanks	Black	8"	02-31951
NEW ProChem® ClamShell Funnel Cover	Black	All	02-33045

*other colors and materials of construction available on request



- Constructed from durable light weight LDPE linear polyethylene.
- Designed to snugly fit 30 and 55 gallon Drums, Intermediate Bulk Containers (IBC's) or any Peabody Tanks with 5" or 8" Twist Lids, including Gemini® Cylindricals, Gemini® Squares, ProChem® Single Wall Tanks, ProChem® Closed Top Tanks, and others.
- Highly chemical resistant.
- Comes standard in black to hide dirt and stains.
- Scalloped clamshell design with integral molded-in ridges to direct flow toward the tank opening and help reduce splashing.
- Molded-in top internal rim flange "splash-guard" to further reduce potential for splashing.
- Integral molded-in nozzle easily fits into from 4" to 8" diameter Drum Bungs, IBC Top Ports and Twist Lids.
- Integral molded-in support lugs hold the funnel securely in place once installed and allows for easy removal when finished.
- Smooth inner surface allows for efficient flow of product from pail or bucket into tank and easy clean-up after filling.
- Optional cover available to contain residue and odors.
- Low cost, so all of your operators and sales force can always have one or more on hand.
- Great for liquid waste collection.

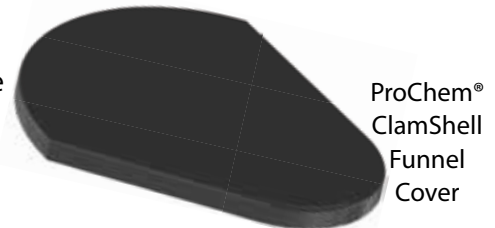

ProChem®
ClamShell
Funnel
Cover



2" Funnel Installed on 55 Gallon Drum
PN 01-32819



4" - 6" Funnel Installed on IBC PN
01-31977



8" Funnel Installed on 120 Gallon Gemini² Dual Containment® Tank
PN 01-31951



Tank Lids

Bolted Lids for ProChem® Open Top Process Chemical Tanks

PE Natural			Shoebox Hinged Lids	Bolted Hinged Lids	
Thickness	Width	Gallons	Part #	SST Part #	Plastic Part #
1/4"	16"	5GAL	02-31606	02-31617	02-33022
1/4"	19"	10GAL	02-31607	02-31618	02-33023
1/4"	19"	15GAL	02-31608	02-31619	02-33024
1/2"	22"	30GAL	02-31609	02-31620	02-33025
1/2"	28"	55GAL	02-31610	02-31621	02-33026
1/2"	34"	100GAL	02-31611	02-31622	02-33027
1/2"	34"	150GAL	02-31612	02-31623	02-33028
1/2"	38"	200GAL	02-31613	02-31624	02-33029
1/2"	53"	300GAL	02-31614	02-31625	02-33030
1/2"	53"	400GAL	02-31615	02-31626	02-33031
1/2"	53"	500GAL	02-31616	02-31627	02-33032

Peabody offers several options for lids on your ProChem® Open Top Process Chemical Tanks. We can add a stainless steel or plastic hinge to your polyethylene lid. If you would like one side to be bolted down and the other open, we can add stainless steel or plastic bolts to the half that stays closed. Add a handle as an option. Call Customer Service for Plastic Options.

PE Handle Part #

02-31628



Shoebox Hinged Lid



Bolted Hinged Lid w/Handle



Lids for Cone Bottom Tanks - TD Series

Description	Shoebox Lids	Shoebox Hinged Lids	Bolted Hinged Lids	
	Part #	Part #	SST Part #	Plastic Part #
19 Gal Cone Bottom Tank Cover	02-27240	02-27249	02-31038	02-33039
25 Gal Cone Bottom Tank Cover	02-27241	02-27250	02-31039	02-33040
40 Gal Cone Bottom Tank Cover	02-27243	02-27253	02-31040	02-33041
40 Gal Cone Bottom Tank Cover - Tall	02-27242	02-27252	02-31041	02-33042
98 Gal Cone Bottom Tank Cover	02-27245	02-27256	02-31042	02-33043
101 Gal Cone Bottom Tank Cover	02-27244	02-27258	02-31043	02-33044



Flat Bolted Lid



Bolted Hinged Lid - SST

Products

Tank Lids - Threaded Twist or Hinged Access Opening

Choose from our easy to install threaded twist lids or our hinged access openings. Whichever you choose, you can be sure that you will receive a quality part that will give you a long lasting trouble free service. Our lids offer a convenient and secure point of entry into your tank for cleaning, visual inspection, filling, manway access, sampling, and just about anything else you may need to do.

Description	Size	Material	Color	Assembly Part #	Lid Only Part #
Threaded Twist Lid	4"	Poly	Black	02-31161	--
Hinged Lid Assembly	5"	Poly	Black	02-28913	--
Vented Lid and Adapter Ring Set	8"	Poly	Black	02-127	02-121
Vented Lid and Adapter Ring Set	16"	Poly	Black	02-151	--
Non-Vented Lid and Ring	16"	Poly	Black	02-133	02-131
Vented Lid and Adapter Ring Set	22"	Poly	Black	02-28449	--
Non-Vented Lid and Ring	22"	Poly	Black	02-30962	--
Hinged Vented Lid and Ring	16"	Poly	Black	02-136	02-137
Hinged Non-Vented Lid and Ring	16"	Poly	Black	02-146	--
Hinged Vented Lid and Ring	22"	Poly	Black	02-30963	--

Threaded Twist



4" Twist Lid on Gemini² Dual Containment® Tank

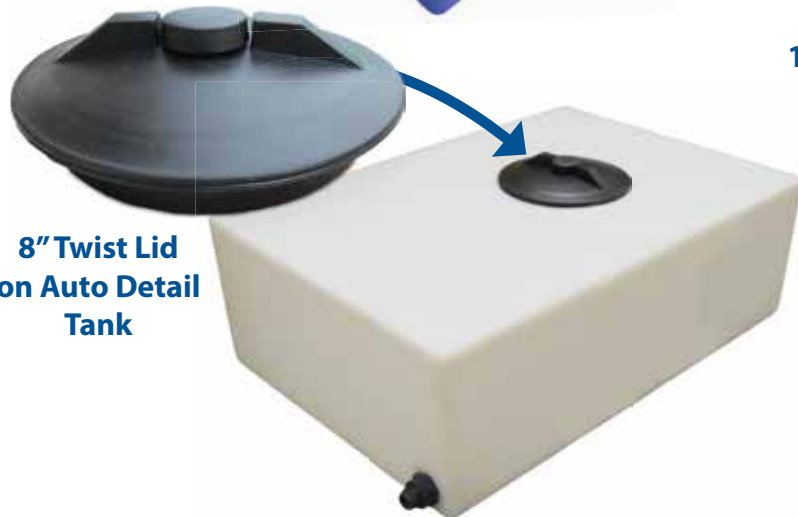

8" Twist Lid on Auto Detail Tank

Hinged Access Opening



5" Hinged Lid on Aquarius Tank

16" Hinged Lid on ProChem® Tank



All lid styles available on a variety of tanks.



NEW ProChem® Lid Locking Kit

ProChem® Lid Locking kits are a quick easy way to lock the lids closed on all our tanks with 4", 8" and 16" twists lids. These kits work on all our Gemini® and ProChem® tanks up to 1300 gallons in round and rectangular sizes. The new ProChem® Lid Locking Kits are available as a kit or can be ordered as part of your tank order and will be pre-installed on your tanks. If you are ordering "Kits" to install in the field on existing tanks, they are supplied with (2) fiberglass "eye" bolts with nuts, a durable 18-8 stainless steel cable with aluminum sleeves as shown in the pictures, and a template for lining up your kit for easy installation.

They are very easy to install, a 5-minute job:

- Simply line up the bolts with the Template provided, one in the lid and one in the tank.
- Drill a 5/16" hole, insert the 1/4" FRP bolt, tighten in place with the 1/4" nuts included in the kit.
- Next, feed the stainless steel cable through the "eye" bolts, insert your own padlock and your lid is secured.

The 4" lid kit is provided with an 8" cable and the 8" and 16" lid kits are provided with a 12" cable.



Description	Part #
ProChem® Lid Locking Kit for 4" Lid - 8" Cable	02-32989
ProChem® Lid Locking Kit for 4" Lid - 8" Cable - Installed on New Tanks	02-32990
ProChem® Lid Locking Kit for 8" & 16" Lid - 12" Cable	02-32991
ProChem® Lid Locking Kit for 8" & 16" Lid - 12" Cable - Installed on New Tanks	02-32992

Products

Gemini® Tank Fittings and Accessories Gemini® Suction Tube Assembly

We have suction tubes for all tank sizes. There are different models for tanks under 60" and over 60". Please specify tank size when ordering. Suction tubes are also available with or without 2" threaded plug connection for optional installation in either 2" female threaded port or pop-in plug/grommet assembly.

Description	Part #
1/4" OD PPL Tube Fitting on Rigid 1/4" PVC Suction Pipe with PVDF Foot Valve – For tanks under 60" tall	02-33352
3/8" OD PPL Tube Fitting on Rigid 1/4" PVC Suction Pipe with PVDF Foot Valve – For tanks under 60" tall	02-33353
1/4" OD PPL Tube Fitting on Rigid 1/4" PVC Suction Pipe with PVDF Foot Valve and 2" Top Plug - For tanks under 60" tall	02-31800
3/8" OD PPL Tube Fitting on Rigid 1/4" PVC Suction Pipe with PVDF Foot Valve and 2" Top Plug – For tanks under 60" tall	02-31801
1/4" OD PPL Tube Fitting on Rigid 1/4" PVC Suction Pipe with PVDF Foot Valve – For tanks 60" and taller	02-33354
3/8" OD PPL Tube Fitting on Rigid 1/4" PVC Suction Pipe with PVDF Foot Valve – for Tanks 60" and taller	02-33355
1/4" OD PPL Tube Fitting on Rigid 1/4" PVC Suction Pipe with PVDF Foot Valve and 2" Top Plug - For tanks 60" and taller	02-33356
3/8" OD PPL Tube Fitting on Rigid 1/4" PVC Suction Pipe with PVDF Foot Valve and 2" Top Plug – for Tanks 60" and taller	02-33357



QCA Tank Fill Quick Connect Assembly

Description	Part #
3/4" Male Quick Connect with Cap - 90° w/o Elbow	02-31802
3/4" Female Quick Connect with Plug - 90° with Elbow	02-31781
1" Male Quick Connect with Cap - 90° w/o Elbow	02-28379
1" Female Quick Connect with Plug - 90° with Elbow	02-31778
2" Male Quick Connect with Cap - 90° w/o Elbow	02-28380
2" Female Quick Connect with Plug - 90° with Elbow	02-31779



Showing Female Connection



Gemini® Replacement Parts

Description	Part #
Suction Tube Grommet with Plug 1/4" Tube Size	02-31805
Suction Tube Grommet with Plug 3/8" Tube Size	02-31806
1/4" Red PE Plug w/EPDM O-Ring	02-28825
3/4" PE Plug	02-31803
1" PE Plug	02-28779
2" PE Plug	02-28780
8" Twist Lid	02-127
16" Twist Lid	02-151
PE Tank Lid Tether	02-31777



Lid and Tank Lid Tether Shown

Spin Weld Fittings

These economical fittings are an excellent choice for top fittings or low-demand bottom discharge fittings. Installation included in price.

Description	Part #
1/4" Spin Weld NPT, PE	02-28812
1/2" Spin Weld NPT, PE	02-29398
3/4" Spin Weld NPT, PE	02-29501
1" Spin Weld NPT, PE	02-28777
1-1/2" Spin Weld NPT, PE	02-29502
2" Spin Weld NPT, PE	02-29628
3" Spin Weld NPT, PE	02-31024



* Not recommended for bottom discharge connections on tanks larger than 100 gallons

Gemini® Double Wall Fittings

Please call customer service to determine what size fitting will fit on your double wall tank.

Size	Bulkhead Dual Sidewall Interconnect Fitting		Welded Dual Interconnect Sidewall Fitting	
	Connection Type: FPT		Connection Type: FPT	Connection Type: FLG
	PVC/EPDM	PVC/Viton	PE	PE/Ring Mat PVC
1/2"	02-28850	02-28855	02-28179	-
3/4"	02-28851	02-28856	02-28180	02-28640
1"	02-28852	02-28857	02-28181	02-28185
2"	02-28853	02-28858	02-28182	02-28186
3"	02-28854	02-28859	02-28183	02-28187
4"	-	-	02-28184	02-28188

Products

NEW 3P Weather-Resistant Document Protectors

Place your important documents in any location, quick and easy.

- The 3P Document Protector is available in 4 standard sizes
- Made from a durable nylon/polyethylene laminate that provides superior moisture resistance and strength.
- Heavy-duty “zip-lock” closure, allows the placement of documents inside the secure enclosure quickly and easily!
- Super strong Duraco high bond adhesive tape on back, allows the enclosure to be easily placed on almost any surface.
- The versatile 3P Document Protector can be placed in the vertical “portrait” position, or on horizontal “landscape” position, whatever works best in each application.

Place and Protect

Caution/Safety signage for chemical tanks, valves and pumps. Works great on plastic, fiberglass, and metal tanks.



SDS sheets can be located near all chemicals for quick easy reference.



Announcements, calendars, and safety procedures can be conveniently placed in offices, lunch rooms and common areas.



Peabody Engineering

I.D. signs for first aid supplies, emergency eyewash units, evacuation instructions for fire drills, etc.



Operating Permits, Licenses and Maintenance Schedules for air compressors and any other machinery. Also works great for placing cautionary labeling near equipment.

Operating instructions/manuals can be located and stored safely and conveniently near any equipment, even on forklifts and other mobile equipment.



02-31945

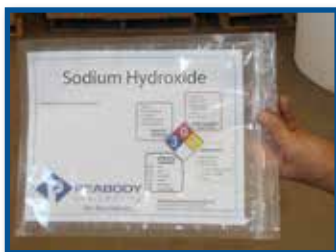

- Temporary signs for parties or other announcements.
- Clean, neat, easy to use and very cost effective.

	Description	Qty	Part #
NEW	Placard Protector, 5.5" x 10" for MSDS and Label	Pack of 25	02-33292
	Placard Protector 10" x 13"	Pack of 25	02-31945
NEW	Placard Protector 10" x 20"	Pack of 25	02-33435
NEW	Placard Protector, 18" x 18" for NFPA Diamond Label	Pack of 25	02-33293



Products

ProChem® Flexible Heating Blanket Systems for Gemini® and ProChem® Tanks

Some chemicals, like caustics, are very sensitive to temperatures below 60 degrees F. Storage and process tanks that are located in cold environments like unheated warehouses and outdoor installations may need “freeze protection” systems as well. If your tank needs to be heated, consider the New ProChem® Flexible Heating Blanket Systems.

ProChem® Flexible Heating Blanket Systems provide a very simple and cost effective method to add a heating system to any of our tanks.

Features:

- ▶ Easy to install. Just wrap around the tank, and attach with integral “quick-release” buckles and straps. That’s it!
- ▶ Easily removed for storage or to install on another tank
- ▶ Folds flat when not in use
- ▶ Adds less than an inch to tank diameter when installed
- ▶ Simple thermostatic control preset for a specific temperature range
- ▶ Adjustable thermostat available as an option
- ▶ Operates from std. 110v power wall socket with 15’ power cord
- ▶ Designed for indoor use, with optional “weather proofing jacket” for outdoor usage areas
- ▶ Higher power units available for more demanding applications
- ▶ Larger Heating Blankets for Larger Tanks are available – contact us for more information
- ▶ We can preinstall the system on your new tanks or ship them to you for your operators to install. Since we have specific models for all of our tank sizes, they are “easy” to install on existing tanks in the field
- ▶ We have (9) different standard models, to fit all of our tanks:
 - ▶ Gemini® Round Tanks
 - ▶ Gemini® Square Tanks
 - ▶ ProChem® Process Tanks
 - ▶ ProChem® Open Top Tanks
 - ▶ ProChem® Closed Top Tanks



Jacket A - Standard	PN 02-32277
Factory Freight Adder (NET add-on to final price)	
Adjustable Size: 37.5"-57"; 10.5" height	
Power: 200W, 110V Single Circuit	
For use with the following Tanks	Tank Size
Open Top	5 Gallon
Closed Top	5 Gallon
Open Top	10 Gallon
Closed Top	10 Gallon
Open Top Nestable	10 Gallon
Open Top	15 Gallon
Closed Top	15 Gallon
Open Top	30 Gallon
Closed Top	30 Gallon
Gemini ² Dual Containment®	5 Gallon
Gemini ² Dual Containment®	10 Gallon

ETL Approved, Meets UL and CSA standards. Ordinary and Hazardous Location products available.



Jacket B - Standard		PN 02-32278
Factory Freight Adder (NET add-on to final price)		
Adjustable Size: 59"-79", 20" height		
Power: 550W, 110V Single Circuit		
For use with the following Tanks	Tank Size	
Gemini Dual Containment®	15 Gallon	
Gemini Dual Containment®	20 Gallon	
Gemini Dual Containment® Flat	40 Gallon	
Gemini Dual Containment® Dome	40 Gallon	
Open Top	55 Gallon	
Closed Top	55 Gallon	
Gemini ² Dual Containment®	20 Gallon	
ProChem®	25 Gallon	
ProChem®	50 Gallon	

Jacket C - Standard		PN 02-32279
Factory Freight Adder (NET add-on to final price)		
Adjustable Size: 80"-98.5", 27.5" height		
Power: 1000W, 110V Single Circuit		
For use with the following Tanks	Tank Size	
Gemini Dual Containment® Flat	62 Gallon	
Gemini Dual Containment®	65 Gallon	
Open Top	100 Gallon	
Closed Top	100 Gallon	
Open Top	150 Gallon	
Closed Top	150 Gallon	
ProChem®	75 Gallon	
ProChem®	100 Gallon	
ProChem®	125 Gallon	
Gemini ² Dual Containment®	40 Gallon	
Gemini ² Dual Containment®	70 Gallon	

Jacket D - Standard		PN 02-32280
Factory Freight Adder (NET add-on to final price)		
Adjustable Size: 106"-126", 37.5" height		
Power: 1350W, 110V Single Circuit		
Jacket D - High Power Dual Circuit		PN 02-32281
Factory Freight Adder (NET add-on to final price)		
Adjustable Size: 106"-126", 37.5" height		
Power: 1700W, 110V Dual Circuit		
For use with the following Tanks	Tank Size	
Gemini Dual Containment®	90 Gallon	
Gemini Dual Containment®	120 Gallon	
Gemini Dual Containment®	160 Gallon	
Open Top	200 Gallon	
Closed Top	200 Gallon	
ProChem®	175 Gallon	
ProChem®	200 Gallon	
Gemini ² Dual Containment®	120 Gallon	



ProChem® Heating System with Gemini Dual Containment® Square Tank (Showing with Optional Single Control)



ProChem® Heating System with Gemini Dual Containment® Cylindrical Tank (Showing Standard Unit)

Products

Jacket E - Standard

PN 02-32282

Factory Freight Adder (NET add-on to final price)

Adjustable Size: 150"-169", 37.5" height

Power: 1350W, 110V Single Circuit

Jacket E - High Power Dual Circuit

PN 02-32283

Factory Freight Adder (NET add-on to final price)

Adjustable Size: 150"-169", 37.5" height

Power: 2200W, 110V Dual Circuit

For use with the following Tanks

Tank Size

Gemini Dual Containment®	220 Gallon
Gemini Dual Containment®	320 Gallon
Open Top	300 Gallon
Closed Top	300 Gallon
Open Top	400 Gallon
Closed Top	400 Gallon
Open Top	500 Gallon
Closed Top	500 Gallon
ProChem®	300 Gallon

Jacket F - Standard

PN 02-32284

Factory Freight Adder (NET add-on to final price)

Adjustable Size: 165"-193", 37.5" height

Power: 1350W, 110V Single Circuit

Jacket F - High Power Dual Circuit

PN 02-32285

Factory Freight Adder (NET add-on to final price)

Adjustable Size: 165"-193", 37.5" height

Power: 2700W, 110V Dual Circuit

For use with the following Tanks

Tank Size

Gemini Dual Containment®	500 Gallon
--------------------------	------------

Additional Options

Weather Jacket

Cost adder for Weather Jacket for outdoor usage.

Weather Covers	Part #
Jacket A	02-32286
Jacket B	02-32287
Jacket C	02-32288
Jacket D	02-32289
Jacket E	02-32290
Jacket F	02-32291

Controllers

These are options for more accurate temperature control. High power units have "Dual Circuits" and therefore could require (2) controllers if you choose to add them.

Control Adders	Part #
Single Control	02-32357
Dual Controls	02-32358



*Optional
Thermostatic
Controller*



Heating and insulation systems are available on all of our larger tanks too. Ask for assistance.



Bulkhead Fittings

Bulkhead Fittings are also known as tank adapters or compression fittings. Standard Bulkheads are spin-tightened, screwing together to create a seal against the tank wall. Bolted Bulkheads create this same seal through the tightening of nuts and bolts. Bulkhead Fittings can be made of various materials and can be used on all plastic tanks in most locations.

Bulkhead Materials

PVC

Polyvinyl Chloride (PVC) bulkhead fittings can be used in a wide variety of applications. It has excellent chemical resistance to most solutions of acids, alkalis, salts, and other organic compounds miscible with water. PVC is not resistant to aromatic and chlorinated hydrocarbons. (32°F to 140°F)

CPVC

Chlorinated Polyvinyl Chloride (CPVC) can be used in the same applications as PVC but can withstand higher temperatures. (32°F to 195°F)

PPL

Polypropylene (PPL) is the lightest of the plastic bulkhead material and can be used in a wider variety of applications than PVC. (-4°F to 195°F)

316 SST

316 Stainless Steel is the strongest of all bulkhead fitting types. 316 SST has a very wide range of chemical resistance and can handle temperatures way beyond that of plastic fittings.

Gasket Materials

EPDM

Ethylene Propylene DieneTerpolymer (EPDM) gaskets are designed especially for acids and can handle many aggressive chemicals, alcohols and environments over time. (-4°F to 195°F) Also called EPT or EPR.

Viton

Viton, or FKM Fluorocarbon Rubbers, are the most chemically resistant, balanced, and have excellent overall properties. Viton is not suitable for caustic chemicals. (-20°F to 302°F)

X-Link

Cross-Link Polyethylene Foam gaskets have a wide range of chemical resistance that match our tank. X-Link has no form memory so removing this fitting after it has been compressed can cause leaks when re-installed later. (32°F to 140°F) Also called XLPE.

Tealon

Tealon is resistant to most chemicals, insoluble, inert, non-flammable, dielectric, naturally lubricated and thermally stable. (-40°F to 302°F)

If you are unsure of which fitting material or gasket is best for your application or have other questions, please contact customer service.

For drop ship orders, not all fittings are available.



Products



PVC Bulkhead Fittings

High quality PVC Fittings come in SxT, TxT, and SxS. Available with EPDM or Viton gasket.

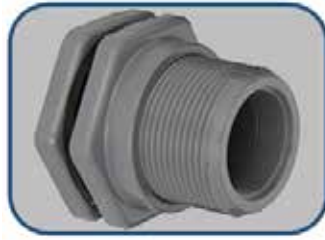

CPVC Bulkhead Fittings

High quality CPVC Fittings come in SxT, TxT, and SxS. Made of Corzan® CPVC and available with EPDM or Viton Gasket.



PPL Bulkhead Fittings

High quality PPL Fittings are only available in TxT. Available with EPDM or Viton gaskets.

Size	Gasket	PVC Bulkhead Fittings			Corzan® CPVC Bulkheads			PPL Bulkheads
		S x T Part #	S x S Part #	T x T Part #	S x T Part #	S x S Part #	T x T Part #	Part #
1/2"	EPDM	10-3666	10-3665	10-3667	10-3584	10-3574	10-3586	10-3587
	Viton	10-3602	10-3600	10-3601	10-3541	10-3866	10-3540	10-3617
3/4"	EPDM	10-3632	10-3654	10-3620	10-3581	10-3538	10-3582	10-3588
	Viton	10-3605	10-3603	10-3604	10-3658	10-3542	10-3543	10-3595
1"	EPDM	10-3622	10-3621	10-3623	10-3578	10-3580	10-3579	10-3589
	Viton	10-3609	10-3606	10-3607	10-3655	10-3863	10-3656	10-3597
1 1/4"	EPDM	10-3625	10-3624	10-3626	10-3575	10-3577	10-3616	10-3591
	Viton	10-3613	10-3610	10-3612	10-3651	10-3653	10-3652	10-3598
1 1/2"	EPDM	10-3628	10-3627	10-3629	10-3566	10-3585	10-3568	10-3743
	Viton	10-3636	10-3633	10-3635	10-3592	10-3615	10-3865	10-3599
2"	EPDM	10-3631	10-3642	10-3641	10-3884	10-3886	10-3885	10-3593
	Viton	10-3645	10-3637	10-3638	10-3868	10-3867	10-3646	10-3608
3"	EPDM	10-3634	10-3873	10-3872	10-3881	10-3883	10-3882	10-3664
	Viton	10-3649	10-3647	10-3648	10-3640	10-3644	10-3643	10-3611
4"	EPDM	10-3870	10-3871	10-3869	10-3576	10-3880	10-3879	10-3596
	Viton	10-3659	10-3650	10-3657	10-3876	10-3874	10-3875	10-3614
6"	EPDM	10-3619	10-3639	10-3630	10-3618	10-3583	10-3663	10-3590
	Viton	10-3662	10-3660	10-3661	10-3864	10-3877	10-3878	10-3594

CPVC, PVDF and Teflon available call for more information.
SxT = Slip x Thread, TxT = Thread x Thread and SxS = Slip x Slip



PVC Small Bulkhead Fittings

PVC Bulkhead fittings are available in smaller sizes for required applications, TxT only.

Specialty and Small Bulkhead Fittings	Bulkhead Fittings	
	1/4" PVC Bulkhead	3/8" PVC Bulkhead
Gasket	Part #	Part #
EPDM	02-29268	02-29270
Viton	02-29269	02-29271

CPVC, PVDF and Teflon available call for more information.

Peabody Engineering



PPL and HD-PPL Bulkheads

Cost effective PPL Bulkheads available with EPDM and Viton only. Heavy duty option available for more demanding needs.

316 SST Bulkheads

High quality Bulkhead fittings are available with EPDM and Viton gaskets. Made with 316 Stainless steel.



Size	Gasket	Economy PPL Bulkhead Adapters and Fittings (T x T)		(T x T)
		PPL	HD PPL	316 SST Bulkhead
		Part #	Part #	Part #
3/8"	EPDM	-	-	02-25955
	Viton	-	-	02-28871
1/2"	EPDM	-	02-24	02-25956
	Viton	-	02-28284	02-28873
3/4"	EPDM	02-85	02-23	02-14952
	Viton	02-28285	02-28286	02-28875
1"	EPDM	02-12	-	02-14951
	Viton	02-28287	-	02-28876
1 1/4"	EPDM	02-10	-	02-14950
	Viton	02-28288	-	02-28877
1 1/2"	EPDM	02-4	-	02-14949
	Viton	02-28289	-	02-28878
2"	EPDM	02-11	02-28775	02-14948
	Viton	02-28290	02-28291	02-28874
3"	EPDM	02-20	-	02-14946
	Viton	02-28292	-	02-28880
4"	EPDM	02-19	-	-
	Viton	02-28293	-	-



Does not include the cost of installation. Please see price sheet for Bulkhead fitting installation charge.



Products



PPL Full Drain Bottom discharge Bolted Fittings Cost effective Bolted Bulkhead available with EPDM or Viton gaskets. Bolts are 316 SST.



316 SST Deluxe Bolted Fittings come as TxT only and are built out of 316 Stainless Steel. The fitting comes with two gaskets: A blind drilled internal and an external with through holes for a tight seal.

Size	Gasket	PPL Bottom Drain Bolted Bulkhead (T x T)	
		Part #	
3/4" x 1"	EPDM	02-51	
	Viton	02-52	
1" x 1"	EPDM	02-14927	
	Viton	02-14926	
1 1/4" x 1"	EPDM	02-14925	
	Viton	02-14924	
1 1/2" x 2"	EPDM	02-14923	
	Viton	02-14922	
2" x 2"	EPDM	02-14921	
	Viton	02-14920	
2" x 2" (Full Port)	EPDM	02-14919	
	Viton	02-14918	
3" x 3"	EPDM	02-14917	
	Viton	02-14916	

Size	Gasket	Deluxe Bolted Fittings 316 SST (T x T)	
		Part #	
1/2"	EPDM	02-15046	
	Viton	02-15039	
	Tealon	02-28671	
1"	EPDM	02-15044	
	Viton	02-15037	
	Tealon	02-28673	
1 1/2"	EPDM	02-15043	
	Viton	02-15036	
	Tealon	02-28674	
2"	EPDM	02-15042	
	Viton	02-15035	
	Tealon	02-28675	
3"	EPDM	02-15041	
	Viton	02-15034	
	Tealon	02-28676	
4"	EPDM	02-15040	
	Viton	02-15033	
	Tealon	02-28677	



Self-Aligning Bulkhead fittings allow for installation of straight piping on the tops of dome tanks or other curved surfaces. Swivel ball connections corrects for the arced surface. Only available double threaded with EPDM or Viton gaskets.

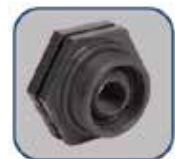

Gasket	Self-Aligning Bulkhead Fittings			
	PPL	PVC		
	2"	1"	2"	3"
	Part #	Part #	Part #	Part #
EPDM	02-28283	02-15009	02-15008	02-15007
Viton	02-29263	02-29273	02-29274	02-29275

Encapsulated st. steel bolts available on polypropylene bolted style fittings.

Welded Couplings

Made from 100% virgin, UV-resistant black polyethylene, our threaded couplings are the best choice for your demanding applications. Since they are welded into your tank, no gaskets are necessary, making them virtually maintenance free. Available in Full (Thd) or Half (Thd) Coupling configuration. PVDF available call for pricing.

Items below includes installation in Single Wall Tanks. Double Wall installation price on request. For loose part (part without installation) please call.

	HD Polyethylene	Polypropylene
	Black Thd Coupling	Natural Thd Coupling
Description	Part #	Part #
1/2" Full Coupling	02-15074	02-27310
3/4" Full Coupling	02-15075	02-27311
1" Full Coupling	02-15076	02-27312
1-1/4" Full Coupling	02-15077	02-27313
1-1/2" Full Coupling	02-15078	02-27314
2" Full Coupling	02-15079	02-27315
3" Full Coupling	02-15080	02-27316
4" Full Coupling	02-15081	02-27317
1/2" Half Coupling	02-15066	02-27302
3/4" Half Coupling	02-15067	02-27303
1" Half Coupling	02-15068	02-27304
1-1/4" Half Coupling	02-15069	02-27305
1-1/2" Half Coupling	02-15070	02-27306
2" Half Coupling	02-15071	02-27307
3" Half Coupling	02-15072	02-27308
4" Half Coupling	02-15073	02-27309



Welded Flanges - Polyethylene

Welded Polyethylene Flanges are designed for demanding applications where a bolted connection is necessary. Great for use with butterfly valves, expansion joints and any application where a permanent gasketless tank wall connection is desired. PVC Flange Rings are Van-Stone style so ring can be rotated to line up with companion flange. Flanges 2" and above include plate gussets for maximum strength. Price includes installation. PPL and PVDF available call for pricing. **Larger sizes available - call for pricing.**

Description	# of Gussets	Part #
1/2" Welded Flange with Ring with Ring	4	02-15090
3/4" Welded Flange with Ring	4	02-15091
1" Welded Flange with Ring	4	02-15092
1-1/2" Welded Flange with Ring	4	02-15094
2" Welded Flange with Ring	4	02-15095
3" Welded Flange with Ring	4	02-15096
4" Welded Flange with Ring	4	02-15097
6" Welded Flange with Ring	4	02-15098
8" Welded Flange with Ring	6	02-15099
NEW 10" Welded Flange with Ring	6	02-15100
NEW 12" Welded Flange with Ring	6	02-15101



Products

Special Application Tanks

Peabody has been in the plastic tank business for over 40 years, so we have seen a very wide variety of applications for plastic storage tanks. Some tank storage applications have unique requirements that are important to understand.

Temperature, Pressure, Vacuum and Venting

Temperature

Polyethylene tanks work well up to about 120 degrees F. Once the temperature exceeds the 120 F ceiling, the physical properties of the tank, specifically wall stiffness, weaken and excessive wall deflection (bulging) becomes an issue.

By adding a fiberglass wrap to the tank, the temperature resistance can be increased up to about 160 degrees F depending on the chemical being stored and other factors in specific applications.

Pressure and vacuum

Polyethylene tanks are designed for non-pressure and non-vacuum applications. They are designed for normal head pressure relative to tank heights. In some situations, poly tanks can handle a couple of PSI from overhead piping and nitrogen blanket systems, but this needs to be considered during the design phase of each installation.

Venting

Since poly tanks are not designed to hold pressure or vacuum, they come standard with vented lids. In other words, vented to atmosphere, to vent both pressure and vacuum.

Rule of thumb for venting a polyethylene tank is to provide a vent one pipe size larger than the largest process fitting, whether that is a suction or discharge fitting. You can consider the vented lids in this calculation and assume the std. 16" lids vent equal to about a 3" pipe size.

Another rule of thumb is, it's better to have too much venting than not enough, so if in doubt, add extra venting.

Pneumatic filling

Filling poly tanks with a pneumatic system from trucks or rail cars is fairly common. If you anticipate this type of filling procedure will be employed on your tank, we recommend you let your tank supplier know, so they can help you make accommodations for that during the tank design phase of your project.

Product Specific Applications Related to Chemical Resistance

There are two families of polyethylene resins used to manufacture rotationally molded tanks, linear polyethylene, and cross-linked polyethylene. There are a variety of differences you need to consider when choosing which type you prefer for your application, but we are going to talk specifically about chemical resistance.

Cross linked polyethylene is not as chemical resistant as linear polyethylene. There are several very popular chemicals that are not compatible with cross linked polyethylene, specifically oxidizers, including the following chemicals:

- Concentrated sulfuric acid
- Hydrogen peroxide
- Sodium hypochlorite, (also called bleach)
- Chlorine dioxide

*If you have other products that are oxidizers and want to check on compatibility, please contact our customer service department. They will be glad to assist you.



We do not recommend using cross linked tanks with linear liners for these applications. Premium linear polyethylene resins have equal or better physical properties than cross-linked polyethylene tanks, so there is no benefit using cross linked tanks with linear liners. Just specify a linear polyethylene tank.

Product specific considerations

*The information below is only a general guide. These are very aggressive chemicals, so please check chemical resistance guides from the manufacturer you plan to buy your components from.

We are not recommending any specific products, only sharing information for you to consider when you configure your tanks for these applications based upon materials typically specified by our customers.

**All information listed below is based on ambient temperatures and atmospheric pressure and vacuum.

Sulfuric acid (up to 98% concentrations)

- 1.9 SPG tanks recommended
- Welded polyethylene fittings work well. We can provide couplings or flanges, but flanges are stronger and a better choice
- PVC valves and fittings are compatible for concentrations up to about 70% with ambient temperatures
- For concentrations above 70%, you should consider using CPVC, PVDF or type 316 st. steel components
- Viton and Teflon gaskets are typically utilized
- Normal venting, specified by project manager
- Double containment recommended
- Ambient Temperatures only; Not recommended for elevated temperature applications

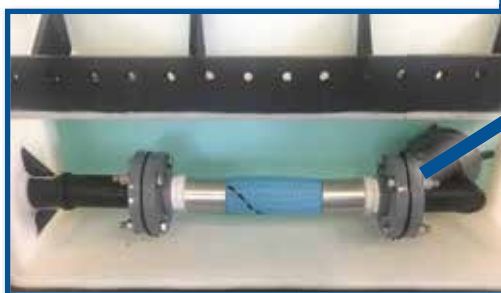

Sodium hypochlorite, (most commonly 12.5% concentrations)

- 1.5 SPG tank, but some prefer 1.9 SPG as an added corrosion barrier
- All non-metallic components recommended
- Welded process fittings work well, as do bulkhead fittings in the correct chemically compatible materials
- We have seen both EPDM and Viton elastomers used in this application
- Normal venting, specified by project manager
- Double containment recommended



Products

Hydrochloric acid/Muriatic acid (37% concentrations)

- 1.5 SPG tank recommended
- All non-metallic components recommended
- Welded process fittings work well, as do bulkhead fittings in the correct chemically compatible materials.
- We have seen both EPDM and Viton elastomers used in this application
- This product has noxious fumes and is typically vented away from operators and equipment, often to a scrubbing system
- Double containment recommended



Hydrogen Peroxide, (typically up to 50%)

- 1.9 SPG recommended
- Welded polyethylene fittings work well. We can provide couplings or flanges, but flanges are stronger and a better choice.
- Passivated type 316 st. steel fittings and piping are frequently used
- Special venting might be recommended
- Double containment recommended



Caustics, (Sodium hydroxide and Potassium hydroxide), various concentrations

- 1.9 SPG recommended
- Welded polyethylene fittings work well. We can provide couplings or flanges, but flanges are stronger and a better choice.
- PVC, CPVC, and type 316 st. steel bulkhead fittings are also used in these applications. PVDF is not recommended.
- Sensitive to temperatures below 65 F, so insulation and heat tracing might be required at 50% concentration
- EPDM elastomers are compatible, Viton is not recommended.
- Double containment recommended.



Chlorine Dioxide

- 1.9 SPG tank recommended
- We have customers that use high density linear polyethylene tanks for this application, but others that prefer PVDF tanks, which are available from Peabody on request in many sizes, both single and double walled models.
- All non-metallic wetted components recommended
- Welded process fittings work well, as do bulkhead fittings in the correct chemically compatible materials.
- Viton and Teflon gaskets are most commonly used in this application
- Teflon and PVDF piping and fittings are most commonly used
- This product has noxious fumes and is typically vented away from operators and equipment, often to a scrubbing system
- Double containment recommended



Other chemicals

- Peabody Engineering publishes a chemical resistance chart you can use as a guide for selecting the proper tank for your applications.
- Please feel free to send us an email or call us for recommendations on specific applications.
- Blended chemicals and proprietary chemicals are difficult to determine regarding compatibility with polyethylene tanks. We have learned that the chemical suppliers often know if polyethylene tanks are compatible with their chemicals and chemical blends, so we recommend asking them about chemical compatibility with polyethylene tanks.

Other resins

Peabody manufactures tanks in the following resins:

- Linear low density polyethylene (LDPE)
- High density linear polyethylene (HDPE)
- High density cross linked polyethylene (XLPE)
- Polypropylene (PPL)
- Polyvinylidene Fluoride (PVDF), also known as Kynar®

*If your chemical is not compatible with our std. LDPE or HDPE resin, check with our customer service representative to see if one of the other resins above will be compatible.

Accessories

Once you choose the right resin, let our customer service team help you choose the best accessories. We can help you put together a complete tank system with everything from simple process connections to certified seismic restraint systems and everything in between.



* Kynar® is a registered trademark of Arkema

Products

Engineered Tank Systems

Value-Paks Single Wall Tank HDPE



Single Wall Tanks are manufactured from a high purity FDA approved HDPE (High Density Linear Polyethylene) resin. HDPE tanks have superior chemical resistance, extreme durability and excellent UV stabilizers, making them an ideal choice for a wide range of applications from food processing and semiconductor to heavy duty industrial chemical storage. Most of our tanks are also NSF 61 compliant.

HDPE resins are weldable, allowing for installation of welded process nozzles from 1/2" to 14" and larger if required.

Our tanks are rated for temperatures up to 120°F and higher with special upgraded enhancements upon request.

Our standard tanks are rated for 1.5 Specific Gravity contents.

We offer 1.9 SPG tanks upon request.

Tank Packages designed with our most popular options making Single Wall Tank Systems simple, feature rich and easy to order.



Capacities and Part Numbers

Name	Diameter	Height	Silver PN	Gold PN	Platinum PN
750 Gallon Single Wall Value Pak	48"	112"	293-33391	293-33392	293-33393
1000 Gallon Single Wall Value Pak	64"	80"	293-29107	293-29129	293-29151
1100 Gallon Single Wall Value Pak	87"	53"	293-29108	293-29130	293-29152
1500 Gallon Single Wall Value Pak	72"	96"	293-29110	293-29132	293-29154
2100 Gallon Single Wall Value Pak	87"	89"	293-29112	293-29134	293-29156
2500 Gallon Single Wall Value Pak	95"	91"	293-29113	293-29135	293-29157
3000 Gallon Single Wall Value Pak	95"	109"	293-29114	293-29136	293-29158
4000 Gallon Single Wall Value Pak	102"	125"	293-29115	293-29137	293-29159
5000 Gallon Single Wall Value Pak	102"	152"	293-29116	293-29138	293-29160
6000 Gallon Single Wall Value Pak	102"	182"	293-29117	293-29139	293-29161
6500 Gallon Single Wall Value Pak	119"	150"	293-29118	293-29140	293-29162
7800 Gallon Single Wall Value Pak	119"	176"	293-29119	293-29141	293-29163
8400 Gallon Single Wall Value Pak	119"	188"	293-29120	293-29142	293-29164
9000 Gallon Single Wall Value Pak	141"	146"	293-29121	293-29143	293-29165
10000 Gallon Single Wall Value Pak	141"	160"	293-29122	293-29144	293-29166
12000 Gallon Single Wall Value Pak	141"	193"	293-29123	293-29145	293-29167
15000 Gallon Single Wall Value Pak	141"	244"	293-29124	293-29146	293-29168

Silver Pak Features

Key ID #	Part	Silver Description
-	Plastic Bulkhead Fittings	Choice of PVC or PPL. Plastic fittings won't corrode over time and are very durable
-	CAD Drawings	CAD Submittal Drawings are provided to ensure the tank meets the needs of your application.
-	Shipping Prep	Includes heavy duty shrink wrap to protect your tank from the elements during transit
1S	18" OD Lid	Standard vented twist lid vents up to 450 gallons per minute during discharge or filling
2S	2" Fill	FPT fill connection high on tank sidewall
3S	2" Drain with Ball Valve	Bolted style polypropylene ball valve screws into 2" Drain for secure on/off draining



Gold Pak Features

Key ID #	Part	Gold Description
-	Silver Features	All features of Silver Pak are included with the following changes/additions
-	Polyethylene Welded Flanges or Couplings*	All Gold Tank's fittings are extension welded and gasketless. Welded fittings provide for industrial grade reliability for all of your tank connections. Made from 100% polyethylene, these fittings are all custom fabricated for optimum performance and chemical resistance
1G	Lifting Lugs	Zinc plated lifting lugs allow quick installation of tank by attaching and hoisting tank into position
2G	Drop Fill Line	Installed into Silver 2" Fill (2S), 42" up from the ground level for easy filling of tank. Includes ball valve, check valve, and PPL quick coupler and cap
3G	Inverse Level Gauge	Standard with fiberglass encapsulated calibration chart in gallons to easily check fluid level from exterior of tank
		*If desired, Stainless Steel Bulkhead fittings can be substituted at no additional cost

Platinum Pak Features

Key ID #	Part	Platinum Description
-	Silver and Gold Features	Platinum Pak includes all features of Silver and Gold Pak plus those seen and listed below (FRP Ladder)
1P	FRP Ladder	FRP Ladders are OSHA compliant, corrosion resistant and attaches directly to tank for easy top access. All ladder systems come with required hardware included.

Additional Single Wall Features and Adders

Additional options including seismic restraint systems, heating and insulation, side manways, level control, etc. are available at an additional cost.



*Custom Designed and Engineered Tank Solutions
High Quality Polyethylene
Single Wall Vertical Tanks*

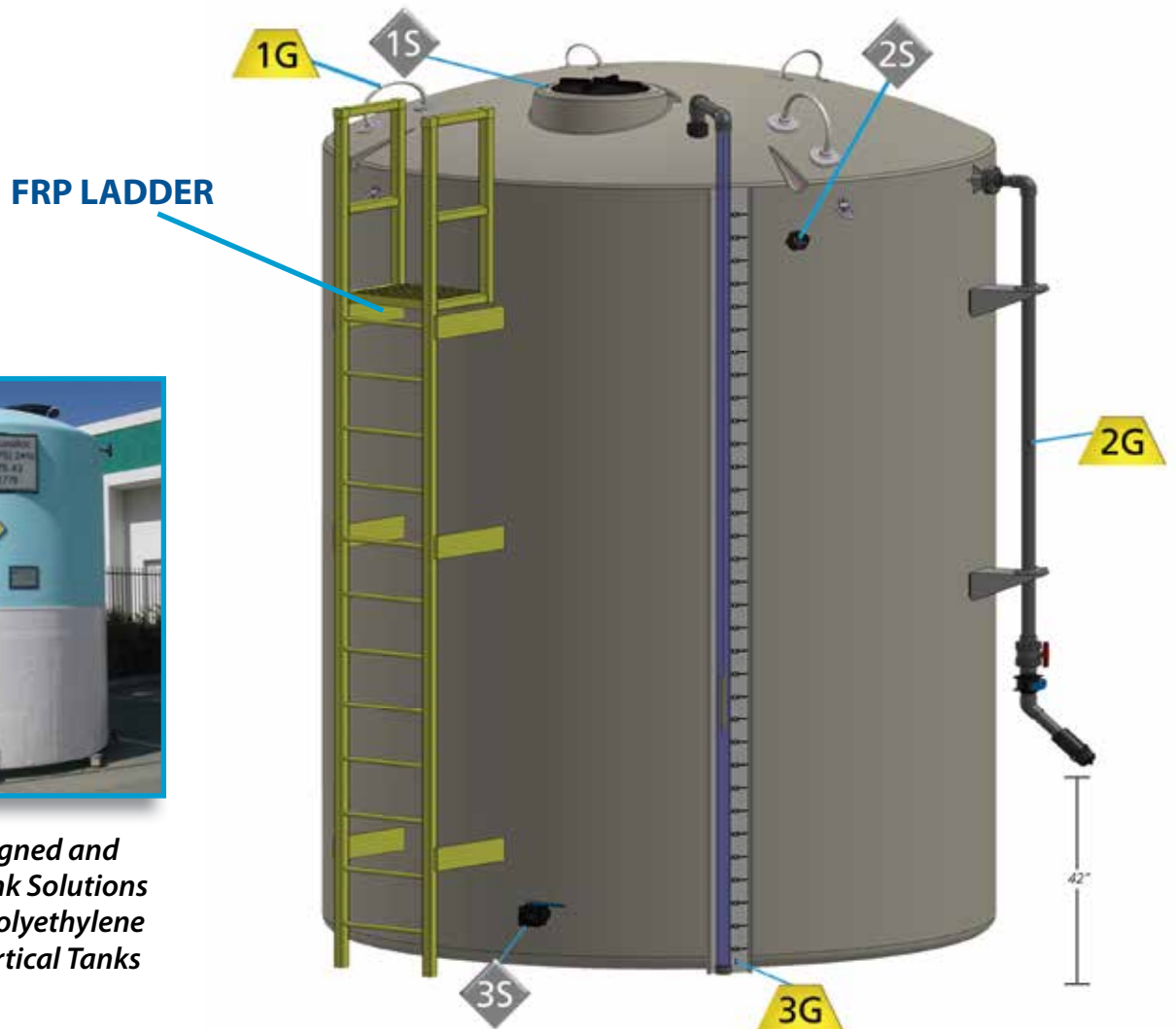

Products

Value-Paks Double Wall Tank HDPE



Double Containment Tanks are manufactured from a high purity FDA approved HDPE (High Density Linear Polyethylene) resin. HDPE tanks have superior chemical resistance, extreme durability and excellent UV stabilizers, making them an ideal choice for a wide range of applications from food processing and semiconductor to heavy duty industrial chemical storage. Most of our tanks are also NSF 61 compliant.

HDPE resins are weldable, allowing for installation of welded process nozzles from 1/2" to 14" and larger if required. HDPE allows us to weld our DCS Double Walled Tank Systems together, making them a true one-piece double walled containment system.

Our tanks are rated for temperatures up to 120°F and higher with special upgraded enhancements upon request.

Our standard tanks are rated for 1.5 Specific Gravity contents. We offer 1.9 SPG tanks upon request.

Tank Packages designed with our most popular options making Dual Containment Tank Systems simple, feature rich and easy to order.



Capacities and Part Numbers

Name	Diameter	Height	Silver PN	Gold PN	Platinum PN
750 Gallon DCS Value Pak	64"	111"	293-33397	293-33398	293-33399
1000 Gallon DCS Value-Pak	72"	80"	293-31962	293-29960	293-31963
1000 Gallon DCS Value-Pak	87"	80"	293-32259	293-32260	293-32261
1100 Gallon DCS Value Pak	95"	53"	293-29171	293-29185	293-29199
1500 Gallon DCS Value Pak	87"	95"	293-29172	293-29186	293-29200
2100 Gallon DCS Value Pak	95"	89"	293-29173	293-29187	293-29201
2500 Gallon DCS Value Pak	102"	91"	293-29174	293-29188	293-29202
3000 Gallon DCS Value Pak	102"	109"	293-29175	293-29189	293-29203
4000 Gallon DCS Value Pak	119"	125"	293-29176	293-29190	293-29204
5000 Gallon DCS Value Pak	119"	152"	293-29177	293-29191	293-29205
6000 Gallon DCS Value Pak	119"	182"	293-29178	293-29192	293-29206
6500 Gallon DCS Value Pak	141"	150"	293-29179	293-29193	293-29207
7800 Gallon DCS Value Pak	141"	176"	293-29180	293-29194	293-29208
8400 Gallon DCS Value Pak	141"	188"	293-29181	293-29195	293-29209

Silver Pak Features

Key ID #	Part	Silver Description
-	Plastic Fittings	Your choice of PVC or PPL. Plastic fittings won't corrode or rust over time and are very durable
-	CAD Drawings	CAD Submittal Drawings are provided to ensure the tank meets the needs of your application
-	Shipping Prep	Includes heavy duty shrink wrap to protect your tank from the elements during transit
1S	2" Mushroom Vent	(2) Vents installed for interstitial venting
2S	2" Top Drain Outlet	FPT drain connection with diptube allows for quickly emptying primary tank
3S	2" Overflow	In case primary capacity is exceeded, liquid drains into interstitial secondary space
4S	18" OD Lid	Standard vented twist lid vents up to 450 gallons per minute during discharge or filling
5S	2" Fill	FPT fill connection high on tank sidewall
6S	1" Drain with Plug	Drain for secondary containment interstitial space, without disrupting liquid being held in primary. Optional shut off valve available



Gold Pak Features

Key ID #	Part	Gold Description
-	Silver Features	All features of Silver Pak are included with the following changes/additions
-	Polyethylene Welded Flanges or Couplings*	All Gold Tank's fittings are extension welded and gasketless. Welded fittings provide for industrial grade reliability for all of your tank connections. Made from 100% polyethylene, these fittings are custom fabricated for optimum performance and chemical resistance
1G	Lifting Lugs	Zinc plated lugs allow quick installation of tank by attaching and hoisting tank into position
2G	Leak Detector	Optical leak detector alerts you of possible leak in secondary interstitial containment space
3G	Drop Fill Line	Installed into Silver 2" Fill (5S), 42" up from the ground level for easy filling of tank. Includes ball valve, check valve, and PPL quick coupler and cap
4G	Inverse Level Gauge	Standard with fiberglass encapsulated calibration chart in gallons to easily check fluid level from exterior of tank

*If desired, Stainless Steel Bulkhead fittings can be substituted at no additional cost

Platinum Pak Features

Key ID #	Part	Platinum Description
-	Silver and Gold Features	Platinum Pak includes all features of Gold Pak plus those seen and listed below (FRP Ladder and Side Access Box)
1P	FRP Ladder (Not Shown)	FRP Ladders are OSHA compliant, corrosion resistant and attaches directly to tank for easy top access. All ladder systems come with required hardware included.
2P	Side Access Box (Not Shown)	Peabody Engineering's unique Side Access Box has a clear cover for visual interstitial leak detection. The flex-hose interconnection system allows for safe movement between the tank walls without putting stress on the lower drain outlet.

Additional Double Wall Features and Adders

Additional options including seismic restraint systems, heating and insulation, fiberglass wraps, level control, etc. are available at an additional cost.



*Custom Designed and Engineered Tank Solutions
High Quality Polyethylene
Dual Containment Tanks*

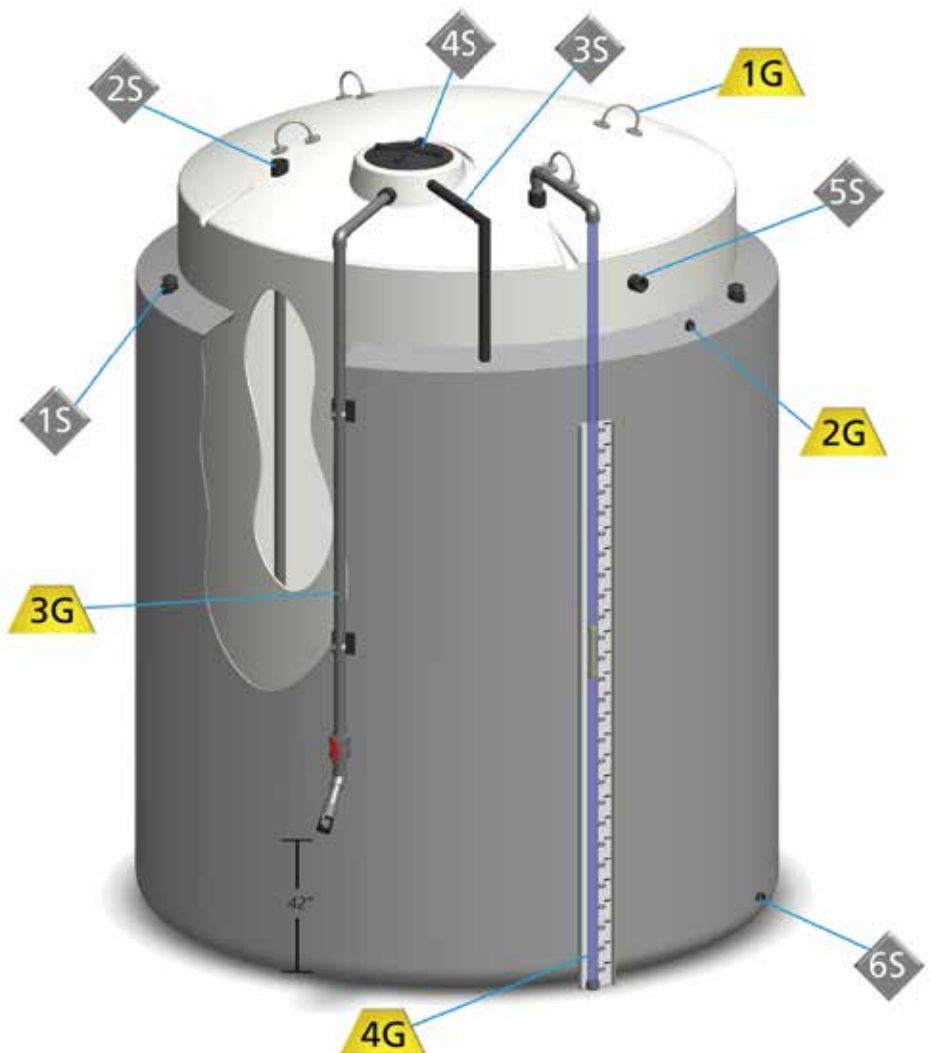



PEABODY

engineering

Rotational Molding

13435 Estelle Street

Corona, CA 92879-1877

490 Sibley Ave

Union Point, GA 30669-1136

800-4-PEABODY | Ph: 951-734-7711 | Fax: 951-734-4111

Gemini and ProChem are Registered Trademarks of Peabody Engineering & Supply, Inc.

© 2020 All rights reserved.

www.4Peabody.com

Sales@4Peabody.com

Commit to the Lord whatever you do and your plans will succeed. Proverbs 10:3

CATPL032020