

PROFILES
by **FRAMEWARE**

PROFILES BY FRAMEWARE



FRAMEWARE LLC

Hanging Hardware Systems

The industry's best source for quality hardware

FRAMEWARE^{LLC}

Hanging Hardware Systems



Founded by Carmen DeLuccia (left) in 1985 and turned over to his son, Dean DeLuccia, now president (right).



Who is Frameware?

Frameware is one of the most respected US manufacturer and distributor of high-quality hanging hardware products serving multiple industries. Operating out of a 25,000 square foot manufacturing and warehousing facility, Frameware offers product distribution services, bulk packaging of hardware components, private label and custom packaging services, and product sourcing expertise.

As part of the Fletcher Business Group brands of solution technologies, Frameware's key hanging products are off-set clips, Heavy Duty Cleats, (ranked the highest weight capacity in the industry, US produced), picture hanging wire and strap hangers, and security hardware kits for hospitality and other business facilities requiring safe, secured hanging.

Frameware's business philosophy for the last 35 years is to set and lead the industry standard in terms of product quality and performance for its hardware line of products.

What markets do we serve?



OEM Picture Framing



Sign and Graphics



Retail Online Framing



Glass, Mirror and Glazing



Hospitality



Woodworking

PROFILES^{by FRAMEWARE}

Your Aluminum Profile Source

Frameware specializes in quality aluminum picture frame moulding and offers both standard and custom profiles for framing OEM's in hospitality, museum, and public space markets. We pride ourselves in maintaining stocking inventory levels for product availability and quick delivery turnaround. We are a primary supplier that is able to source and deliver what you need, within your cost budget, and delivery requirements. See page 27 for details.



Custom Packaging and Private Label

Frameware offers custom packaging solutions for the OEM and online retailers allowing them to attach hardware kits as part of their finished products. It can be simply a functional clear bag with printed instructions, or the package can be private labeled bringing additional value to your end consumer. Being a US manufacturing, we have the ability of supplying both smaller and larger quantities which can be difficult to source from other off-shore suppliers.

What do we offer to the marketplace?

Revenue and profit generator for online retailers

Customized packaging and private label opportunities

Consistent product quality and quick turnaround fulfillment

Packaging options and product count configurations for single or bulk kits

Pre-assembled hanging hardware – labor savings due to fast installation

Security hanging hardware for hospitals, hospitality and retail

US-produced heavy duty cleats with industry's highest weight rating

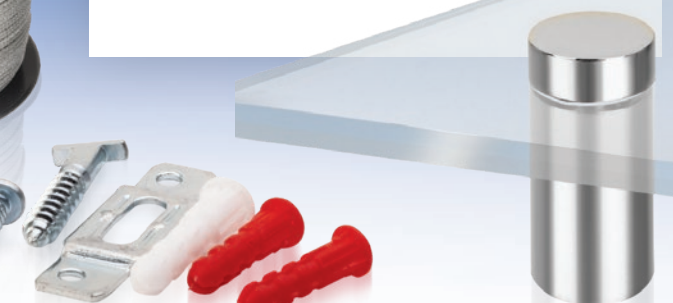
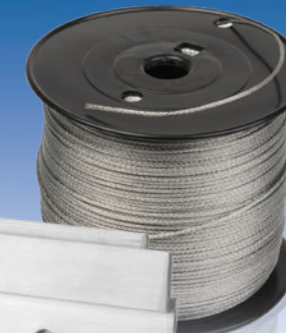
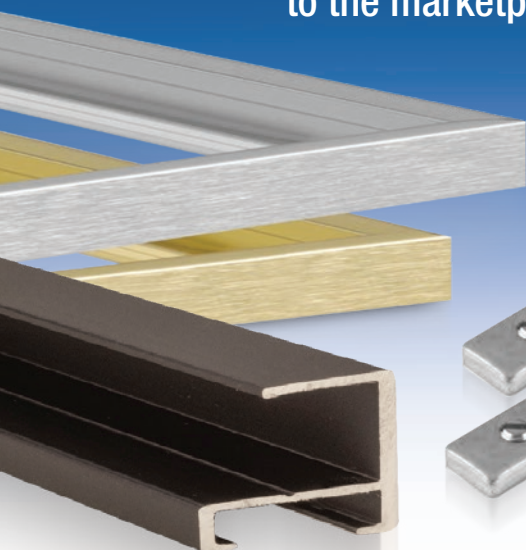

Aluminum Moulding Profile Line

Mouldings... Aluminum extrusions... Profiles.... No matter what you call it, Profiles by Frameware is committed to framing the future in metal by bringing you quality material for metal picture frames. Custom quotes available for Profiles needed in a finish not listed.



STANDARD ALUMINUM MOULDING PROFILES

All Profiles available in the following finishes unless otherwise specified:



01 - BRIGHT SILVER

02 - SATIN SILVER

03 - BRIGHT GOLD

04 - SATIN GOLD

28 - BRIGHT BLACK

29 - SATIN BLACK

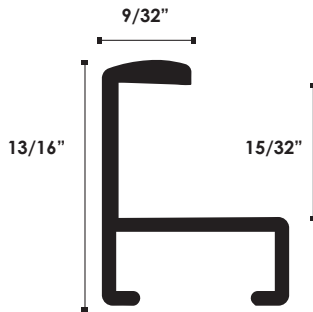

Profile 711

Feet per Box: 560ft.

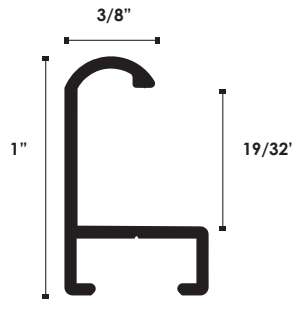

Profile 741

Feet per Box: 400ft.

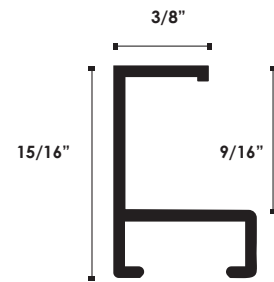

Profile 751

Feet per Box: 480ft.

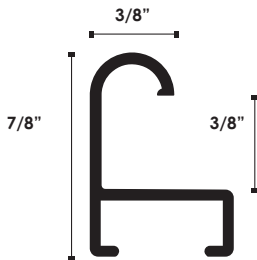

Profile 811

Feet per Box: 480ft.

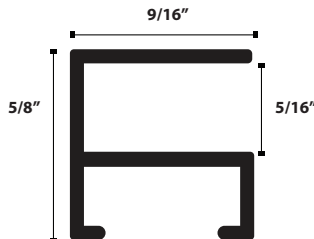

Profile 112

Feet per Box: 180ft.

*Available finishes:
Satin Silver only

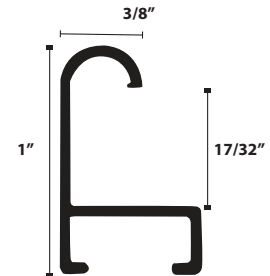

Profile 812

Feet per Box: 480ft.

* Available finishes:
Satin Silver & Satin Black

* STANDARD BRUSH SIDE ON ALL FINISHES

ALUMINUM MOULDING PROFILE LINE

STANDARD PROFILES

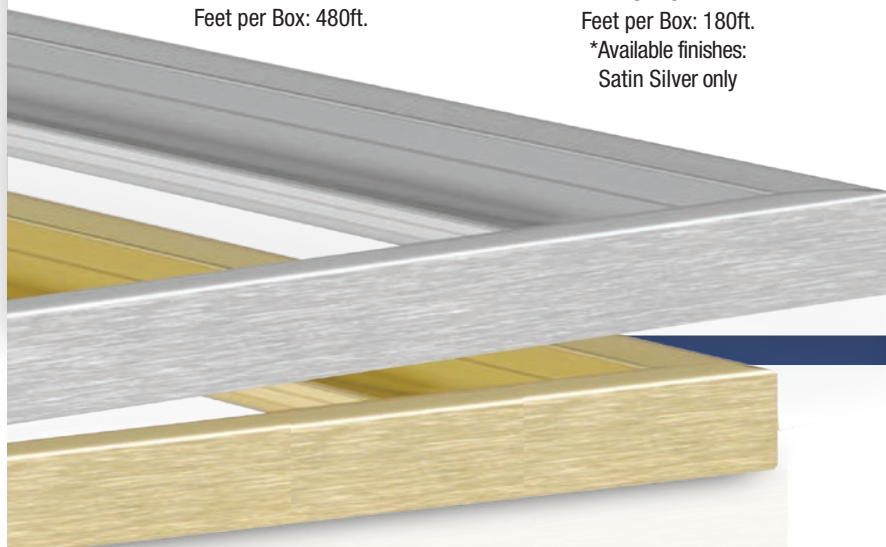

Aluminum Moulding Profile Line

Mouldings... Aluminum extrusions...Profiles... No matter what you call it, Profiles by Frameware is committed to framing the future in metal by bringing you quality material for metal picture frames. Custom quotes available for Profiles needed in a finish not listed.



CUSTOM ALUMINUM MOULDING PROFILES

All Profiles available in the following finishes unless otherwise specified:



01 - BRIGHT SILVER

02 - SATIN SILVER

03 - BRIGHT GOLD

04 - SATIN GOLD

28 - BRIGHT BLACK

29 - SATIN BLACK

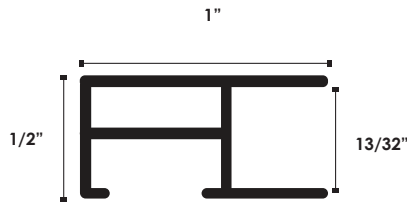

Profile 97

Feet per Box: 240ft.
*Available finishes:
Mill & Satin Black

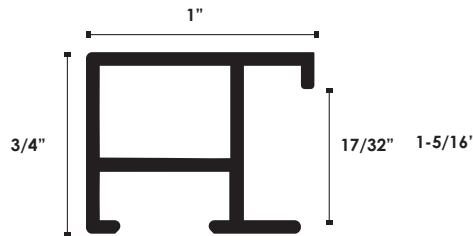

Profile 95

Feet per Box: 240ft.
Also available: Satin Silver
& Satin Black

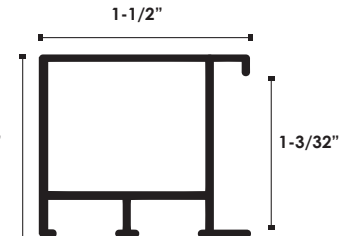

Profile 28

Feet per Box: 80ft.
*Available finishes: Satin Black
& Satin Silver

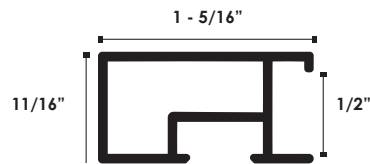

Profile 101

Feet per Box: 160ft.
*Available finishes: Bright Silver
& Satin Silver

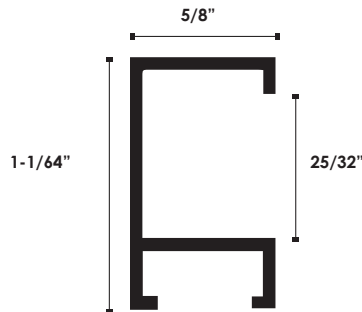

Profile 94

Feet per Box: 300ft.
*Available finishes: Satin Black

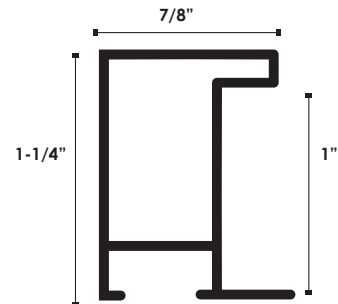

Profile 109

Feet per Box: 300ft.
Also available: Satin Silver,
Satin Gold, Satin Black

* STANDARD BRUSH SIDE ON ALL FINISHES
CALL FOR CUSTOM COLORS



ALUMINUM MOULDING PROFILE LINE

CUSTOM PROFILES

Aluminum Moulding Profile Line

Mouldings... Aluminum extrusions...Profiles... No matter what you call it, Profiles by Frameware is committed to framing the future in metal by bringing you quality material for metal picture frames. Custom quotes available for Profiles needed in a finish not listed.



CUSTOM ALUMINUM MOULDING PROFILES

All Profiles available in the following finishes unless otherwise specified:



01 - BRIGHT SILVER

02 - SATIN SILVER

03 - BRIGHT GOLD

04 - SATIN GOLD

28 - BRIGHT BLACK

29 - SATIN BLACK

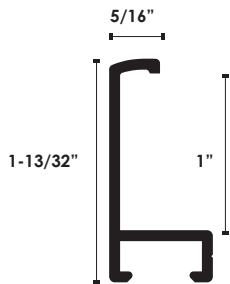

Profile 72

Feet per Box: 320ft.
Available finishes: Satin Silver, Satin Gold & Satin Black & Bright Silver w/ a brushed side

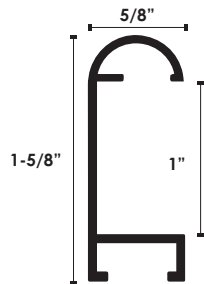

Profile 108

Feet per Box: 240ft.
Available finishes: Satin Silver, Satin Gold & Satin Black & Bright Silver w/ a brushed side

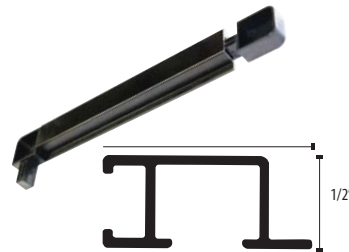

Profile 199

Require Moulding Caps for Assembly
Available finishes: Satin Silver & Satin Black

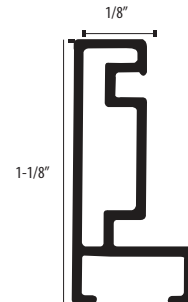

Profile 169

Feet per box: 300ft
Available finishes: Satin Silver & Satin Black w/ brushed side and top

Profile 115 - new moulding specially designed for surface mounting!

Reduce your assembly time with new Profile 115 - specifically designed for surface mounting. The frames are straight cut and then connected together with plastic caps - no hardware or tools required! Pair this moulding with our chop program for complete ease of use!

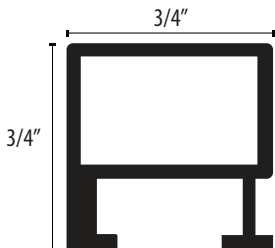

Profile 115

Feet per box: 180ft
Available finishes: Mill Finish

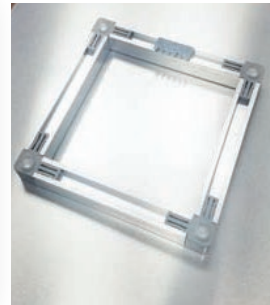
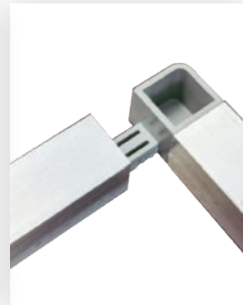
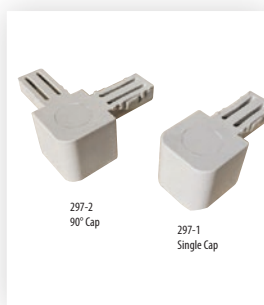

AFTER ASSEMBLY, HANG WITH YOUR PREFERRED METHOD, SUCH AS THE FRAMELOC SYSTEM OR A NOTCHED SAW TOOTH HANGER.

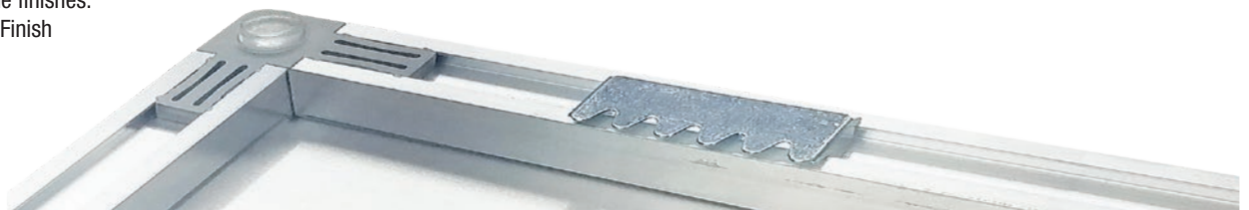

Profiles Chop Program

The extremely attractive aspect of buying through Profiles by Frameware is our Chop Program. Supply us with the dimensions of your frame, and we'll do the rest! The moulding will be mitre cut, cleaned, and wrapped in pairs. Price includes the hardware to assemble and hang.



PROFILES CHOP PROGRAM

Supply us with the dimensions of your frame and **PROFILES BY FRAMEWARE** will do the rest!



- Minimum order of \$35.00
- All profiles available
- The moulding chops will be mitre cut, cleaned, and wrapped in pairs
- Price includes all hardware*: taped corner angles, back plates, spring clips, and hangers
- Made in the USA

*SEE PAGE 11 FOR HARDWARE DETAILS

ALUMINUM Moulding PROFILE LINE

Profiles for Surface Mounting

Metal moulding from Profiles by Frameware is the fastest and easiest way to hang a variety of die-sublimated materials such as acrylic, aluminum, and other graphics or signage. Using metal moulding allows your artwork to "float" off the wall, and gives you a variety of options for hanging. Works perfectly with Profiles #28, #94, #95, #9 You will need: 7, #109 and the NEW #115.

ASSEMBLE ATTACH HANG

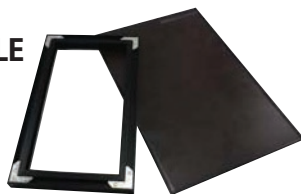

ASSEMBLE THE FRAME USING TAPPED ANGLES AND BACK PLATES. PROFILES BY FRAMEWARE OFFERS A COMPLETE CHOP PROGRAM WHICH INCLUDES THESE PIECES.



EXTREME HIGH BOND TAPE (PAGE 36)

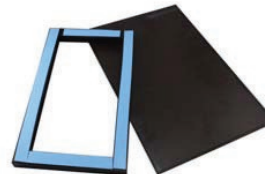

ATTACH THE EXTREME HIGH BOND TAPE (PAGE 36) TO THE TOP OF THE Moulding. REMOVE THE PROTECTIVE LAYER FROM THE TAPE. CENTER THE ARTWORK OVER THE FRAME, AND PRESS FIRMLY TO THE BACK OF YOUR IMAGE.



EHB TAPE ATTACHES YOUR PROFILE TO THE PANEL

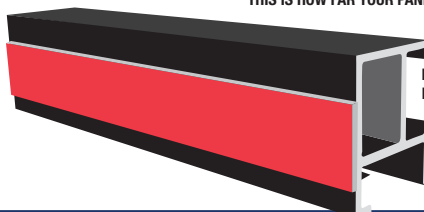

THIS IS HOW FAR YOUR PANEL WILL SIT OFF THE WALL.

HANGING HARDWARE GOES IN THIS CHANNEL

Hang the finished artwork using your preferred method. We recommend a Frameware Heavy Duty Cleat - it fits directly into the channel of the moulding. For extra security, use the Frameloc System.

PROFILE CHOPS/SURFACE MOUNTING

Frameware Online Store – Shop for all your picture framing and hanging hardware needs

Visit www.Framewarellc.com to purchase all types of hanging and assembly hardware used daily in your framing or graphic shop. Looking for a security hanging solution, check out our FrameLoc and Three-Point Security Systems; hanging and displaying acrylic and metal artwork or graphics, we offer a complete range of sizes of stand-offs; need to hang heavy framed artwork or mirrors, our line of US produced Heavy Duty Cleats is your answer.

Shop today for all the best prices, selection and product availability!



Where to find us



Find us on social media:
www.facebook.com/Framewarellc



@Frameware

and on the web:
www.framewarellc.com
compatible with most web browsers, smartphones & tablets!

FRAMEWARE^{LLC}
Hanging Hardware Systems