

Electric Lift Chair Assembly Instruction

						
Chair base	Backrest	Left and right armrest	Power cord	Remote control	Power Source	Anti-fall bracket x2

STEP 1

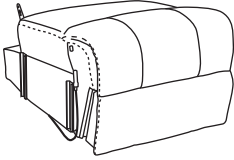
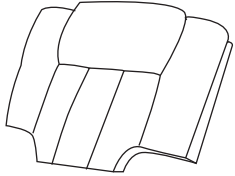
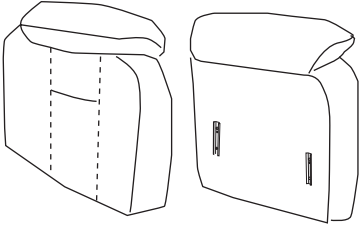
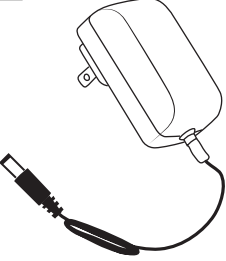
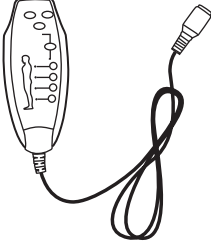
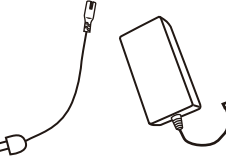
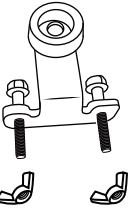
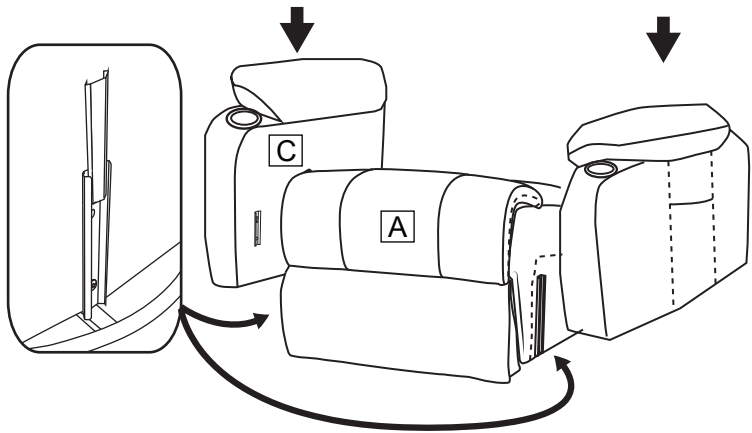

Insert two armrests to the chair base, make sure the slots on the armrests fully assembled to the bottom part.

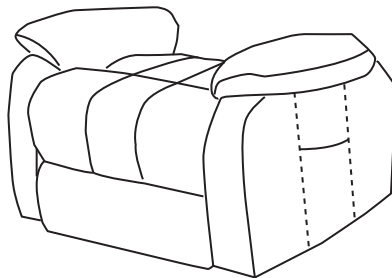

STEP 2

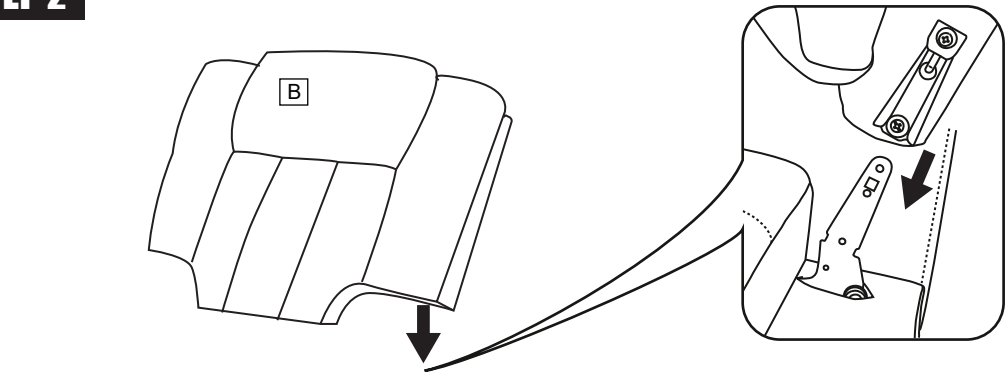

Insert chair back to the chair base, make sure the slots on the back fully assembled to the bottom part.

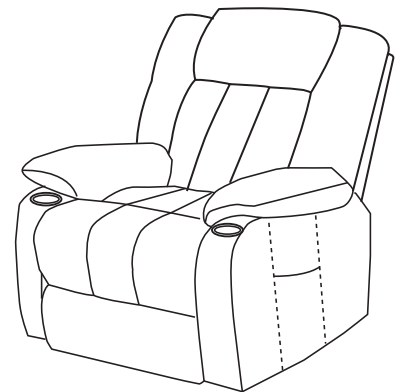
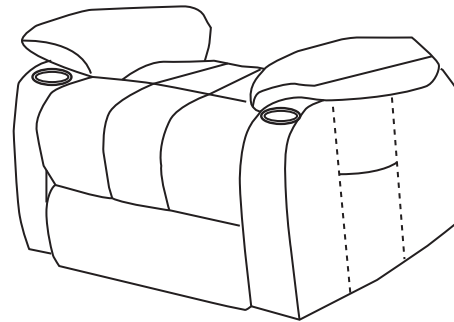

Electric Lift Chair Assembly Instruction

STEP 3

- No.1 and No.2 wire connect with the backrest and chair base.
- No.3 wire connects with backrest and power cord(D).
- No.4 wire connects with backrest and remote control(E).
- No.5 wire connect the motor and the wire from rightside armrest, which use to connect the control panel.
- No.6 wire connect the motor and power source (F).

NOTE

- 1: Two same color wires connect.
- 2: Plug power cord and power source into outlet, then you can use all function.

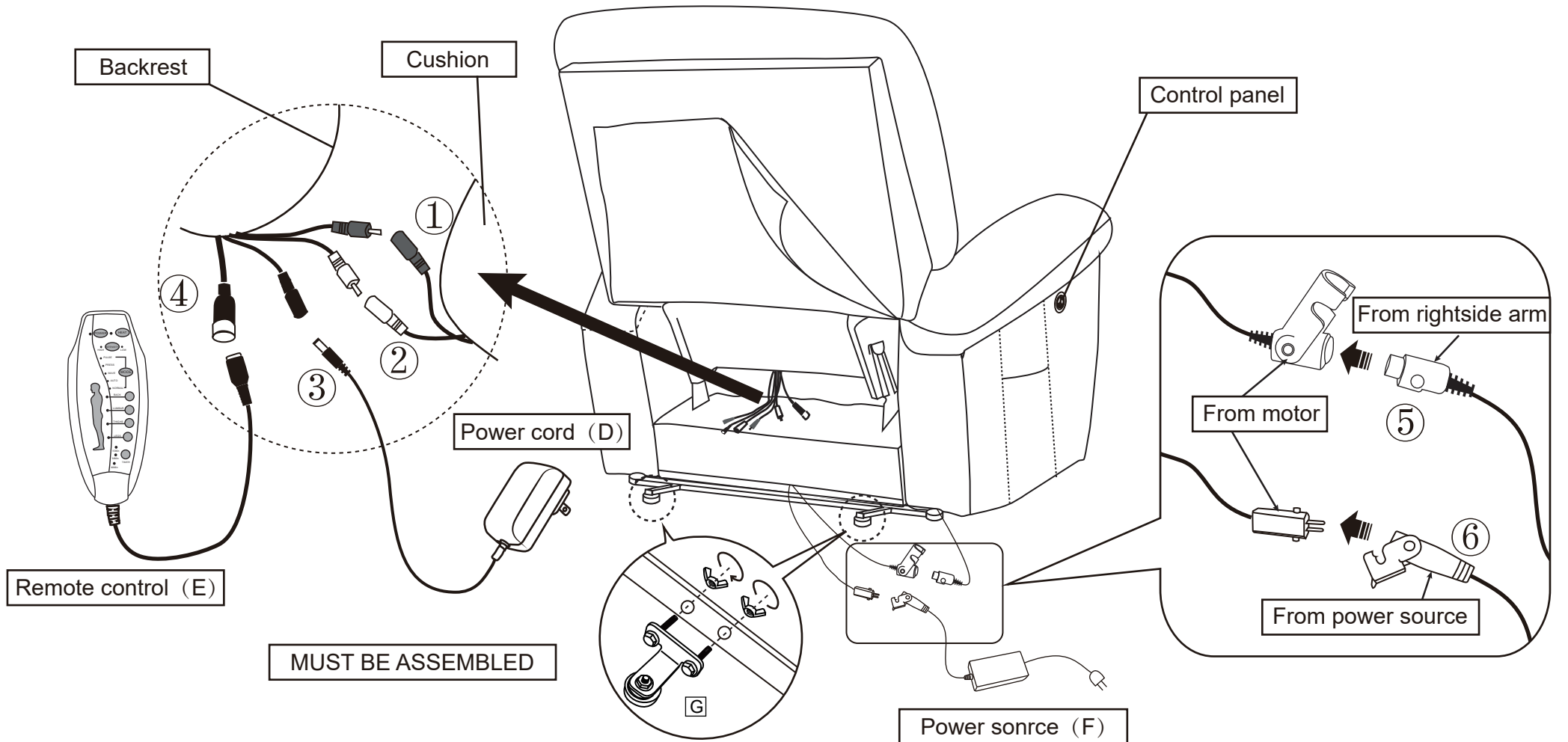

Electric Lift Chair Assembly Instruction

How to recline?

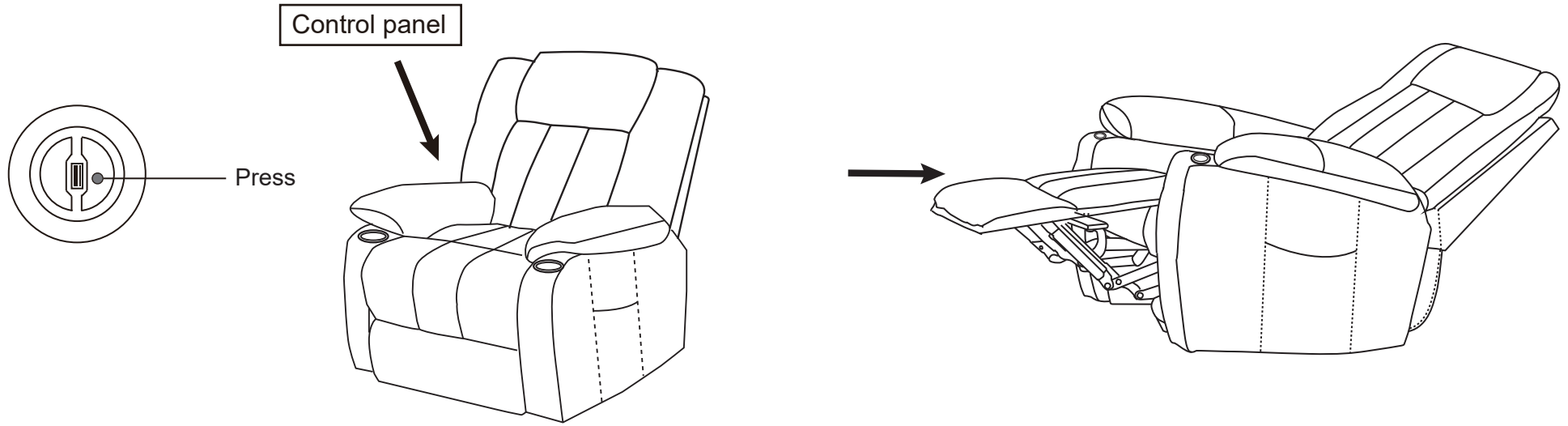

How to get footrest latch down and stand?

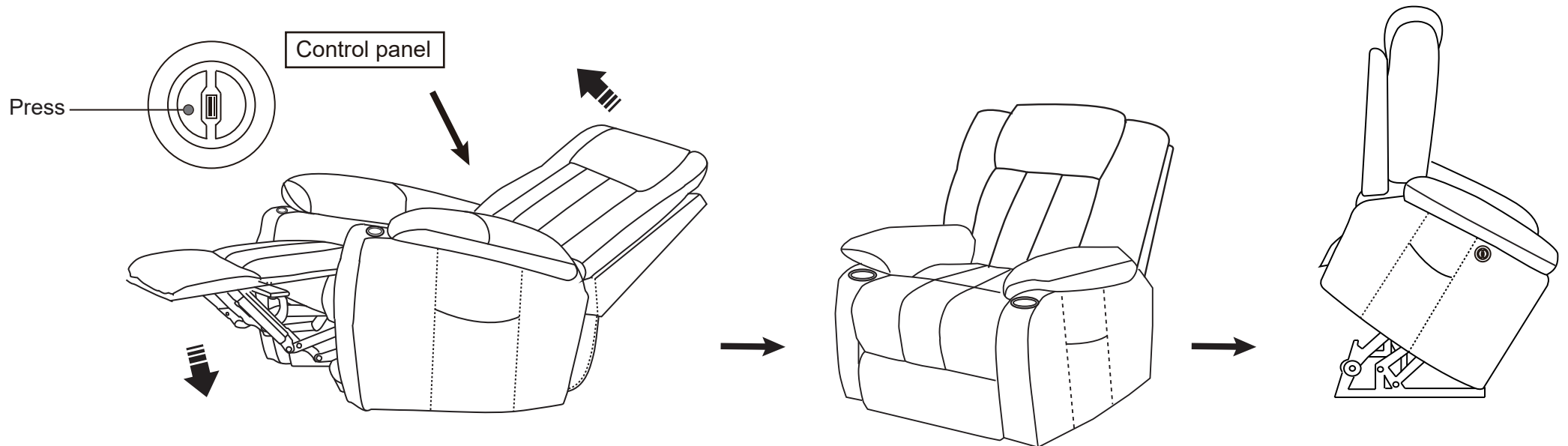

Electric Lift Chair Assembly Instruction

How to use remote control?

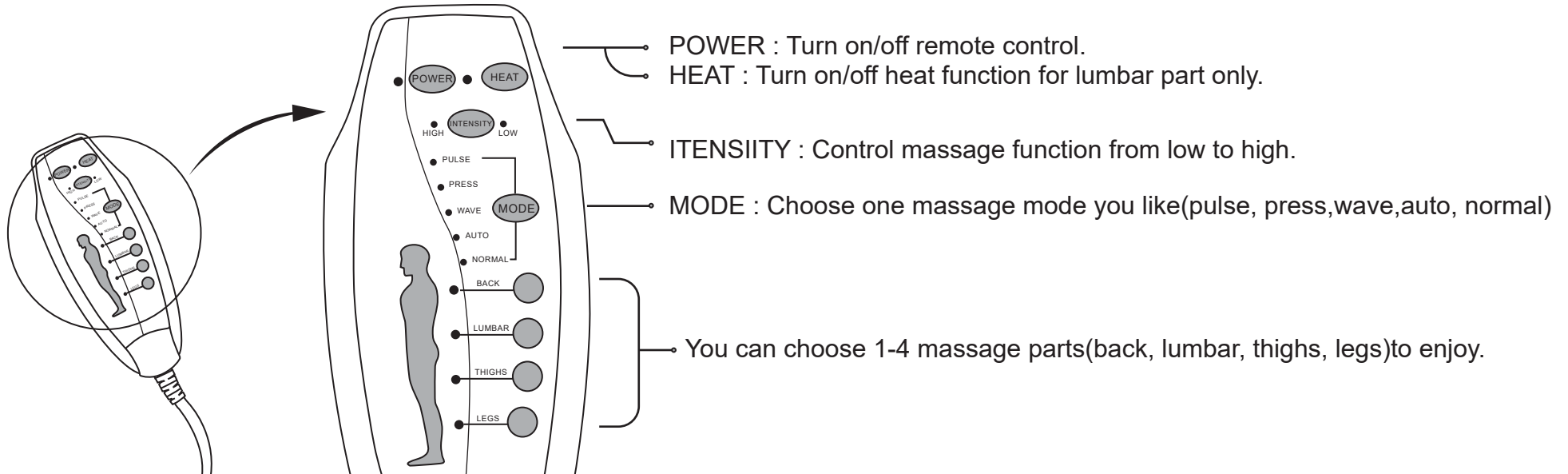

How to use control panel that outside of right armrest?

Control panel is for chair lift and reclining function, also has dual USB outlets (5V 2A) that keep your devices charging, such as nearly all smartphone(like iPhone, Samsung..), ipad, headphones, Kindle...

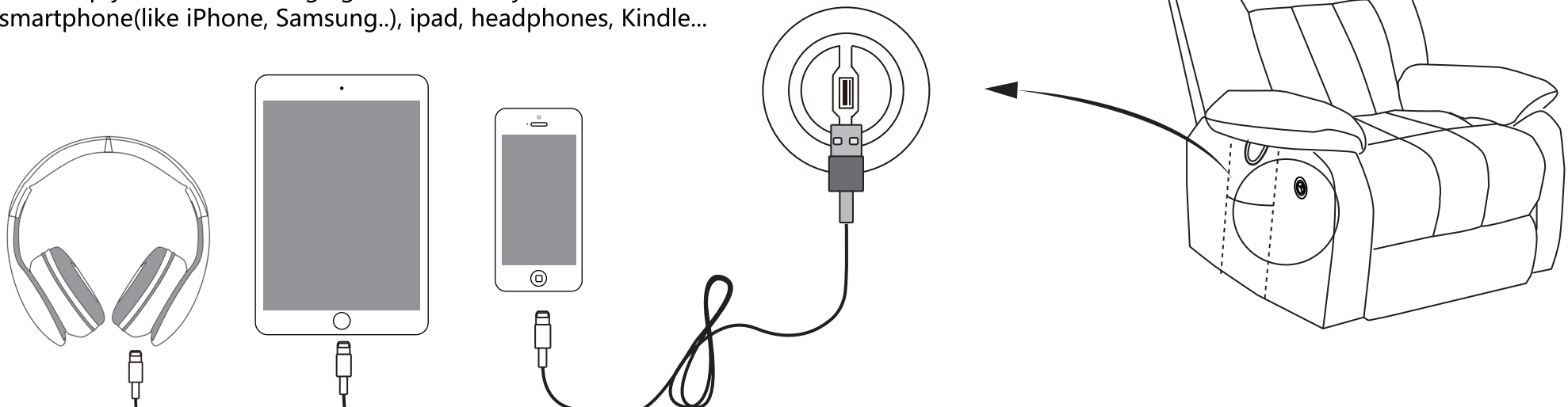

Electric Lift Chair Assembly Instruction

FAQ

1.Q: Missing parts when received.

A: Please check if you already received two boxes we shipped to you. Sometimes the two boxes will not arrive in same date, hope you can wait for 2-3 more days or contact us for more help.

If you already have two boxes, please kindly send us messages to let us know the name of missing part regarding to the first page of instructions. We will send replacement to you asap.

2.Q: Some parts damaged when arrived.

A: Please send clear photos about damaged part to us as attachment, we will check and offer you best solution soon.

3.Q: The massage function does not work.

A: Please check if all wires connect correctly, the power cord (D) may be defective if indicator does not light on, or if the lights doesn't turn on when you press "POWER" button on the remote, that means the remote is defective.

Please kindly send messages with clear photos to describe the problem, then we will send necessary replacement to you.

4. Q: The chair is stuck on lifting or reclining position, and no response when you press the lifting or reclining button.

A: Please kindly check if the power source (F) and control panel are connected well with lift motor(Wire #5 & #6). Sometimes the power source (F) and control panel may fall off from the motor. If they connect well, then check the lift motor if it has some anomaly, like some noise comes out when you press the lift and recline button. If you can make sure the motor is defective, please contact us for replacement.

5. Q: The Heat function does not work or can't feel.

A: Please check all wires connection the same as question 3 first. If the remote also works well, you will need wait for 5-10 mins after you press the "HEAT" button. The heating function only works at lumbar position and the heat temperature isn't very hot.