

MANGO POWER E

Quick Start Guide

Disclaimer

Read this Quick Start Guide carefully before using the product to ensure that you completely understand the product and can correctly use it. After reading this user manual, keep it properly for future reference. Improper use of this product may cause serious injury to yourself or others, or cause product damage and property loss. Once you use this product, it is deemed that you understand, approve and accept all the terms and content in this document. MANGO POWER is not liable for any loss caused by the user's failure to use this product in compliance with this Quick Start Guide.

In compliance with laws and regulations, MANGO POWER reserves the right to the final interpretation of this document and all documents related to this product. This document is subject to changes (updates, revisions, or termination) without prior notice. Please visit MANGO POWER's official Guide website to obtain the latest product information.

INSTRUCTIONS PERTAINING TO RISK OF FIRE, ELECTRIC SHOCK, OR INJURY TO PERSONS

IMPORTANT SAFETY INSTRUCTIONS

- **WARNING** – When using this product, basic precautions should always be followed, including the following:

1. Read all the instructions before using the product.
2. To reduce the risk of injury, close supervision is necessary when the product is used near children.
3. Do not put fingers or hands into the product.
4. Use of an attachment not recommended or sold by MANGO POWER may result in a risk of fire, electric shock, or injury to persons.
5. To reduce risk of damage to the electric plug and cord, pull the plug rather than the cord when disconnecting the power pack.
6. Do not use a battery pack or appliance that is damaged or modified. Damaged or modified batteries may exhibit unpredictable behavior resulting in fire, explosion or risk of injury.
7. Do not operate the power pack with a damaged cord or plug, or a damaged output cable.
8. Do not disassemble the power pack. Take it to a qualified service person when service or repair is required. Incorrect reassembly may result in a risk of fire or electric shock.
9. To reduce the risk of electric shock, unplug the power pack from the outlet before attempting any servicing.
10. **WARNING – RISK OF EXPLOSIVE GASES.**

To reduce risk of battery explosion, follow these instructions and those published by MANGO POWER and manufacturer of any equipment you intend to use in vicinity of the battery. Review cautionary marking on the product.

PERSONAL PRECAUTIONS

- a) Have plenty of fresh water and soap nearby in case battery acid contacts skin, clothing, or eyes.
 - b) Wear complete eye protection and clothing protection. Avoid touching eyes while working near the battery.
 - c) If battery acid contacts skin or clothing, wash immediately with soap and water. If acid enters eye, immediately flood eye with running cold water for at least 10 minutes and get medical attention immediately.
 - d) NEVER smoke or allow a spark or flame in vicinity of the battery.
 - e) Be extra cautious to reduce risk of dropping a metal tool onto battery. It might spark or short-circuit battery or other electrical part that may cause explosion.
11. When charging the internal battery, work in a well-ventilated area and do not restrict ventilation in any way.
 12. Under abusive conditions, liquid may be ejected from the battery; avoid contact. If contact accidentally occurs, flush with water. If liquid contacts eyes, additionally seek medical help. Liquid ejected from the battery may cause irritation or burns.
 13. Do not expose a power pack to fire or excessive temperatures. Exposure to fire or temperatures above 130°C (265°F) may cause an explosion.
 14. Have servicing performed by a qualified repair person using only identical replacement parts. This will ensure that the safety of the product is maintained.

- **OPERATING INSTRUCTIONS**

1. Instructions regarding battery charging, temperature limits for appliance, battery-use, and storage, and the recommended temperature range for charging.
2. Indoor-use only power packs.

SAVE THESE INSTRUCTIONS

Contents

Technical Specifications	01
Features	03
Getting Started	04
Touch Screen.....	04
AC Charging	05
Solar Charging.....	05
E+ Function.....	06
E-Link Function	06
MANGO POWER App	07
What's In the Box	07
Storage and Maintenance	07
Safety Instructions	08
Alarm Prompt Comparison Table	09

Technical Specifications

Model		MANGO POWER E
Product Name	Mobile energy storage	
General		
Net Weight	100.1lbs(45.4kg)	
Size	17.8x13.6x19.4 inches(452x345x494 mm)	
Working Temperature	Charging: -10°C~45°C (14°F~113°F) Discharging: -20°C~45°C (-4°F~113°F)	
Warranty	5 years	
Certifications	Meets US and International Safety and EMI Standards	
Quick Charge	Recharge to 80% in 1 hour Recharge to 100% in 1.5 hours	
Running Noise	<40dB under no-load <51dB under full-load	
IP level	IP21	
Capacity Expansion	Can expand the capacity by one E Battery to 7066Wh	
Power Expansion	Can expand the power by two to 6000W	
240V split phase	With mSocket Pro or mPanel(sold separately), can output 240V split phase, 6000W	
Home Backup	Support (need mPanel Pro)	
Battery		
Battery Capacity	3533Wh	
Cell Chemistry	World's best CATL LFP	
Life Span	Capacity Retention >70% after 6000 cycles (@25°C, +0.5C/-0.5C)	
Battery Management Systems	Over Voltage Protection, Overload Protection, Over Temperature Protection, Short Circuit Protection, Low Temperature Protection, Low Voltage Protection, Overcurrent Protection	
Max charging rate	Up to 1.1C	
Input		
Charging Method	AC Wall Outlet, Solar Panel, EV Charger, Generator	
AC Charging	Max 3000W	
Solar Charging	Max 2000W (60V-150V)	
EV AC Charging Spot	Adapter needed	
Generator	Support	
Inverter		
Rated AC Output Power	3000W, 120V AC, 60Hz	
Power of Over-load	3150W<loads>3750W, 5mins; 3750W<loads>4500, 60s 4500W<loads>4800W, 10s 4800W<load, less than 40ms	
Maximum Power Point Trackers	1x, Support Both Roof and Portable Solar Panels	
Inverter Efficiency	Up to 88%	
Output		
Output Ports	16	
AC Output Ports	4 x 20A	
USB-A	6 x QC 3.0 24W	
USB-C	1 x PD 65W+ 1 x PD 100W	
Car Power Output	12V/10A	
DC5521 Output	2x12V/5A	
AC RV Port	30A	

Smart Control	
Connection	Bluetooth and Wi-Fi
App Remote Control	Yes
OTA Upgrade	Yes
Customized Mode	Backup Power Mode / Economical Mode / Time-based Control Mode
Smart Measurement	Yes
Smart Energy and Carbon Footprint Report	Yes
Smart Notifications	Yes
Screen	
Size	4.3 Inches
Touch Screen	Yes
Resolution Ratio	480 x 800
Screen pigment	16.7M colors
Safety	
Smart Self-Check System	Yes

- Whether the product can be charged or discharged depends on the actual temperature of the battery pack.

Features

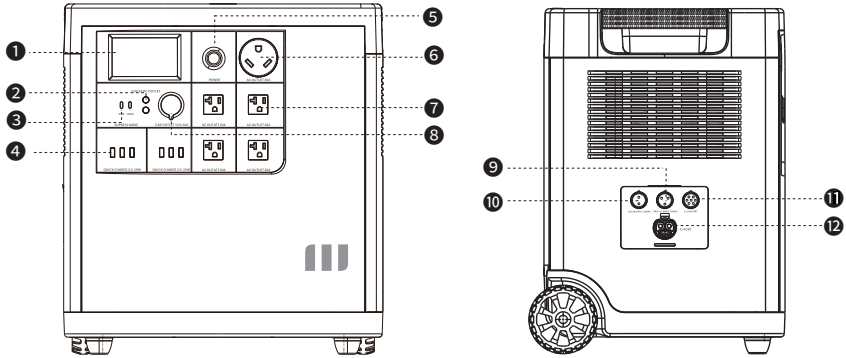

No.	Name	Description
①	Touch Screen	Can be pressed/tapped to control the MANGO POWER E
②	2x DC 5521 12V/5A output	Traditional ports for routers, cameras, old laptops, etc.
③	USB-C 65W/100W output	Can be used to charge most devices currently on the market at 65W/100W Max
④	6x USB-A 24W output	Quick charge USB-A ports
⑤	Power button	Short/Long press to turn MANGO POWER E ON/OFF
⑥	AC TT-30P	NEMA TT-30: standard recreational vehicle connector (120V/30A), also known as RV 30
⑦	4x AC output	Standard AC receptacle: widely used in areas that use 100-120V; generates almost same AC power as a household wall outlet
⑧	DC 12V/10A cigarette lighter port	Output port for devices with a corresponding plug such as vehicle-use vacuums, refrigerators, etc.
⑨	Grid AC input	Can connect the MANGO POWER E to grid for AC charging
⑩	Solar input	Can be connected to solar panels
⑪	E-Link Port	Connection port between two MANGO POWER E's to generate 240V split phase
⑫	E+ Port	Connection port for the MANGO POWER E to connect with MANGO POWER E Battery

Getting Started

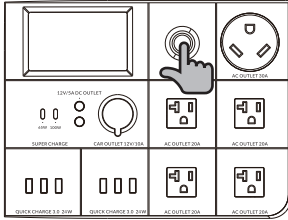

Short press to turn on

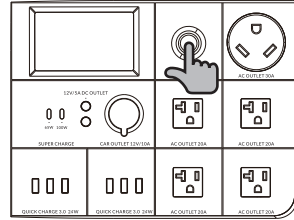

Long press to turn off

Startup: Short press the power button for 1 second. The power button indicator will illuminate and the touch screen will light up.

Shutdown: Long press the power button for 5 seconds. The power button indicator will turn off. The MANGO POWER E's DC and AC power switches are integrated into the interaction LCD screen; press "DC" button and/or "AC" button on the screen to turn on/off the DC/AC output.

Touch Screen

You can download the Touch Screen User Manual at link: <https://www.mangopower.com/us/-support/download/index>, or scan the QR code on the last page.

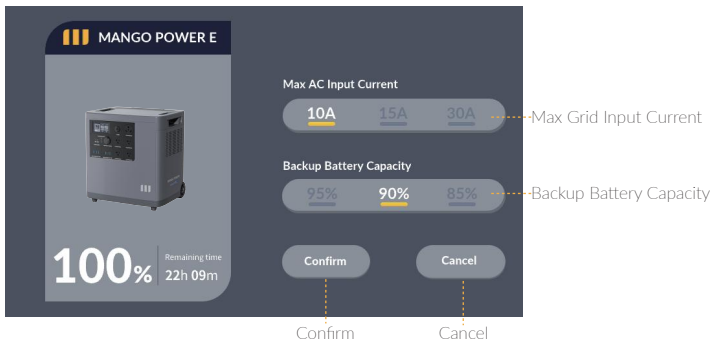
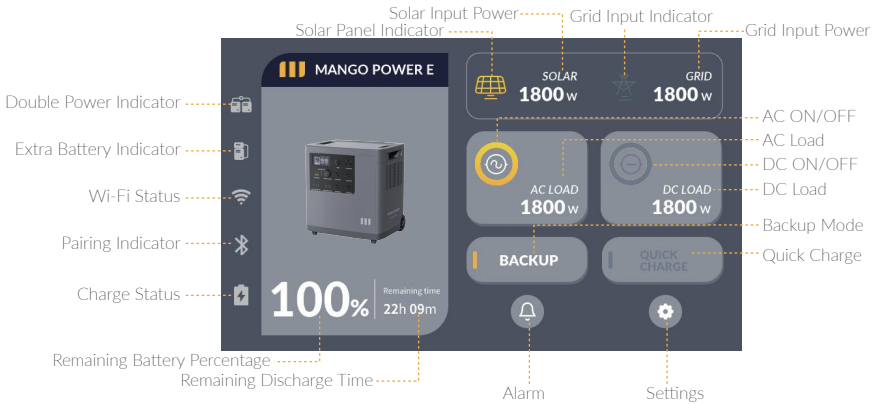

AC Charging

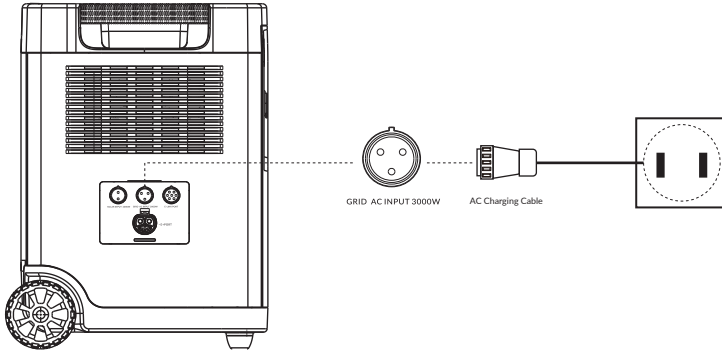

Connect the MANGO POWER E from Grid AC Input port via the inbox 15A AC charging cable to the wall outlet.

1. The default charging power is less than 500W.
2. Click the Quick Charge button (on the touch screen). The default value is less than 1500W/100Vac, 1800W/120 Vac. When the power level reaches 100%, it will automatically stop charging.

In addition, you can choose to purchase a 30A fast charge cable, the maximum allowed charging power will be up to 3000W. (Please make sure the home outlets you connect to support a current of more than 30A. At the same time, in the case of no AC input, set the maximum grid input current to 30A on the touch screen)

Solar Charging

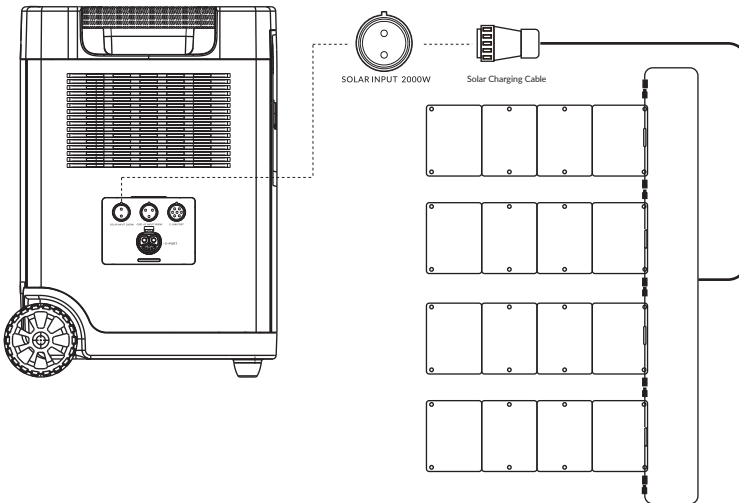

1. Connect solar panels in series as shown in the figure, and recharge the MANGO POWER E via Solar Charging Cable (MC4 to aviation cable).
2. MANGO POWER E supports 60-150V DC input, 20A max current, and 2000W max charging power. Before connecting the solar panel, please ensure that the solar panel's output voltage is within 150V to avoid product damages.

E+ Function

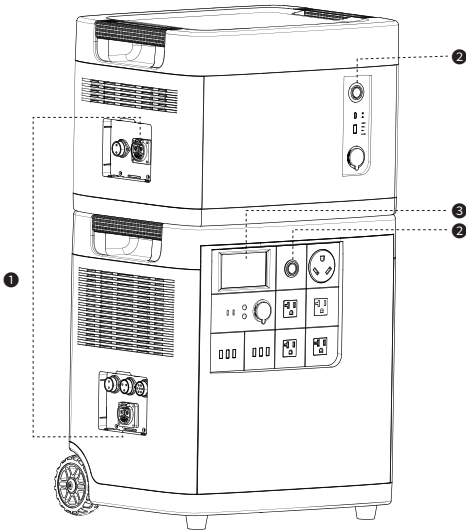

MANGO POWER E can link the MANGO POWER E Battery to expand the battery capacity to 7066Wh.

Turn off both the MANGO POWER E and MANGO POWER E Battery before connecting or disconnecting them;

- 1 Connect the MANGO POWER E and E Battery via an E+ cable;
- 2 Turn on the MANGO POWER E and MANGO POWER E Battery;
- 3 Before use, make sure the MANGO POWER E is displaying the extra battery icon on its touch screen.

E-Link Function

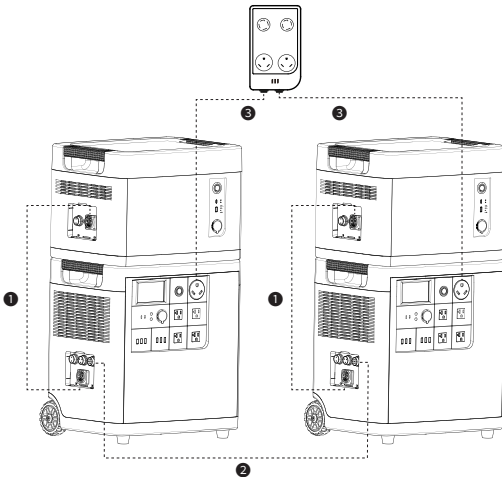

Two MANGO POWER E units can be linked together with an E-Link cable to double the output power and voltage.

Please disconnect the AC charging cable for both MANGO POWER E units while plugging into the mSocket Pro;







- 1 Connect the MANGO POWER E and E Battery via an E+ cable;
- 2 Connect two MANGO POWER E's via an E-Link cable;
- 3 Plug in two MANGO POWER E's into the mSocket Pro;

Turn MANGO POWER E and MANGO POWER E Battery on and tap the AC ON/OFF on one of the MANGO POWER E's touch screens. You can get output power and voltage doubled from the mSocket Pro.

MANGO POWER App

The MANGO POWER E support both Wi-Fi and Bluetooth connections. Please download the MANGO POWER App from the iOS App Store or Google Play before installing the MANGO POWER E. You can download the APP and APP User Manual at link: <https://www.mangopower.com/us/support/download/index>, or scan the QR code on the last page

What's In the Box

No.		Category	Quantity
1		MANGO POWER E	1
2		AC Charging Cable	1
3		Solar Charging Cable	1
4		Quick Start	1
5		Warranty Card	1
6		QC PASS Certificate	1

Storage and Maintenance

- Ideally, use and store the product in a place of between 20°C~30°C (68°F~86°F), and always keep it away from water, intense heat, and sharp objects. For an extended product lifespan, do not store it in places of temperatures above 45°C (113°F) or below -10°C (14°F).
- For long-term storage, please discharge the product every three months (firstly discharge it to 0%, then fully recharge it, and lastly discharge it to 60%); the product will not be covered by the warranty if it is not charged or discharged for more than 6 months.

Safety Instructions

- Carefully read this document before installation and use. Otherwise, serious damage or personal injury may result.
- This battery contains compounds which may be harmful, carcinogenic, or cause fertility disorders if improperly handled. Do not remove the internal battery without the express permission of the manufacturer or one of its designated suppliers.
- We're proud of the MANGO POWER E's lightweight design, but it is still a 42kg+ product. Please be careful when handling and use an auxiliary transport tool if necessary.
- If you notice any extrusion, deformation, or other defect of your MANGO POWER E, immediately stop use of the product, and contact our support staff.
- Before undertaking any installation or wiring, first make sure the MANGO POWER E's Power Button and Breaker are in the "off" position.
- Do not dismantle or attempt to dismantle the MANGO POWER E without the express permission of the manufacturer. Some of its parts are not replaceable. If you have any issue with your MANGO POWER E, contact our support staff. If maintenance is required, professional maintenance engineers will be required.
- To protect the product during transportation, please do not stand or sit on the MANGO POWER E's packing boxes. When opening and unpacking, be sure to handle with care. Do not place other items on top of the MANGO POWER E.
- Do not install the MANGO POWER E near a heater or other heat source. It is prohibited to place or operate this equipment in an environment with any flammable, explosive gas, or smoke.
- Do not install the MANGO POWER E any place where it will be directly exposed to the rain, and do not allow it to soak in water or any other liquid.
- Please do not use chemical cleaners or expose the MANGO POWER E to any other flammable or volatile chemicals.
- Do not use spray products to clean the MANGO POWER E.
- This product should only be installed in environments that stay within its operating temperature range: Charging: -10°C~45°C (14°F~113°F) Discharging: -20°C~45°C(-4°F~113°F)
- Strictly follow guidelines laid out in this user manual when installing or using your MANGO POWER E.
- Only use official accessories from MANGO POWER to use in conjunction with your MANGO POWER E.
- Do not insert foreign objects into any of the MANGO POWER E ports (whether AC or DC or ventilation holes). This power station generates the same potentially lethal AC power as a household wall outlet. Please use it carefully and keep children away from it.

Alarm Prompt Comparison Table

Part	Prompt	Reason	Treatment measure
PCS	PE001	High-grid voltage	1. Check if the AC input interface is properly connected; 2. Check if the grid voltage waveform is normal; The voltage can be automatically recovered within the normal range.
	PE002	Low-grid voltage	1. Check if the AC input interface is properly connected; 2. Check if the grid voltage waveform is normal; The voltage can be automatically recovered within the normal range.
	PE004	High-grid frequency	1. Check if the AC input interface is properly connected; 2. Check if the grid voltage waveform is normal;The grid frequency can be automatically recovered within the normal operating range.
	PE005	Low-grid frequency	1. Check if the AC input interface is properly connected; 2. Check if the grid voltage waveform is normal;The grid frequency can be automatically recovered within the normal operating range.
	PE006	High bus voltage	The voltage can be recovered automatically without any operations.
	PE007	Low bus voltage	The voltage can be recovered automatically without any operations.
	PE008	AC overcurrent protection	1. Check if there is a short circuit in the bypass circuit; 2. Check if the current is greater than the set impulse current. Click the Clear Fault button on the screen, or restart the machine to recover.
	PE009	High PFC MOSFET temperature	1. Check if it exceeds the ambient temperature of product operations; 2. Check if the fan outlet is blocked; 3. Reduce the charging and discharging power.The temperature can recover after restart.
	PE010	High temperature on the original side of MOSFET on the DC side	1. Check if it exceeds the ambient temperature of product operations; 2. Check if the fan outlet is blocked; 3. Reduce the charging and discharging power.The temperature can recover after restart.
	PE012	AC fuse failure	Repair and maintenance are recommended.
	PE013	Overtemperature of the PTC thermistor	Repair and maintenance are recommended.
	PE015	Low AC load voltage	1. Check if the access load power exceeds the rated power; 2. Please reduce the access load power. Click the Clear Fault button on the screen, or restart the machine to recover.
	PE016	High AC load voltage	Check if the external voltage is output to the bypass output, causing the high voltage. Click the Clear Fault button on the screen, or restart the machine to recover.
	PE017	Frequency loss	1. Check if the AC input interface is properly connected; 2. Check if the grid voltage waveform is normal;The power supply can be automatically recovered within the normal range.
	PE018	Slow startup fails.	Repair and maintenance are recommended.
	PE019	Grid voltage loss	1. Check if the AC input interface is properly connected; 2. Check if the grid voltage waveform is normal;The power supply can be automatically recovered within the normal range.
PE021	AC load over-power	1. Check if the access load power exceeds the rated power; 2. Please reduce the access load power. Click the Clear Fault button on the screen,or restart the machine to recover.	
PE022	High AC load frequency	Check if the operating frequency of the load exceeds the output frequency of the equipment.Restart the machine to recover.	
PE023	Low AC load frequency	Check if the operating frequency of the load exceeds the output frequency of the equipment.Restart the machine to recover.	

Part	Prompt	Reason	Treatment measure
PCS	PE024	Bypass circuit output overcurrent	1. Check if the bypass circuit load power exceeds the rated power; 2. Please reduce the load power. Click the Clear Fault button on the screen, or restart the machine to recover.
	PE025	The frequencies of parallel machines are mismatched.	Check if the output frequencies of the two parallel machines are identical to each other. Click the Clear Fault button on the screen, or restart the machine to recover.
	PE026	The PFC temperature detection element is abnormal.	Repair and maintenance are recommended.
	PE027	The temperature detection element on the DC high-voltage side is abnormal.	Repair and maintenance are recommended.
	PE028	The temperature detection element on the DC low voltage side is abnormal.	Repair and maintenance are recommended.
	PE029	Check the frequency of parallel machines, and perform an ex-factory inspection.	Repair and maintenance are recommended.
	PE033	High DC voltage	Check if the battery voltage is too high. The voltage can recover after restart.
	PE034	Low DC voltage	1. Check if the battery voltage is too low; 2. Check if the load is too large, causing battery protection. The voltage can recover after restart.
	PE035	Short circuit on the DC side	Check if the load has short-circuited. It can recover after restart. If the fault still exists, repair and maintenance are recommended.
	PE036	Overcurrent protection on the DC side	Check if the load has short-circuited. It can recover after restart. If the fault still exists, repair and maintenance are recommended.
	PE037	Buck overcurrent protection	Check if the load has short-circuited. It can recover after restart. If the fault still exists, repair and maintenance are recommended.
	PE039	Synchronous rectification and MOSFET overtemperature	1. Check if it exceeds the ambient temperature of product operations; 2. Check if the fan outlet is blocked; 3. Reduce the charging and discharging power. The temperature can recover after restart.
	PE040	PCB environment overtemperature	1. Check if it exceeds the ambient temperature of product operations; 2. Check if the fan outlet is blocked; 3. Reduce the charging and discharging power. The temperature can recover after restart.
	PE041	The battery voltage is low.	1. Battery capacity is low, please charge; 2. Reduce the load. Click the Clear Fault button on the screen, or restart the machine to recover.
	PE043	Parallel communication disconnected	Please check if the parallel communication line is connected properly. Automatic recovery
	PE044	EEPROM fault	It can recover after restart. If the fault still persists, repair and maintenance are recommended.
	PE045	LLC overcurrent protection	Check the load situation, and reduce the power. Click the Clear Fault button on the screen, or restart the machine to recover. If the fault still exists, repair and maintenance are recommended.
	PE046	Internal communication fault	It can recover after restart. If the fault still persists, repair and maintenance are recommended.
PE047	High bus voltage	The voltage can be recovered automatically without any operations.	
PE048	Low bus voltage	The voltage can be recovered automatically without any operations.	

Part	Prompt	Reason	Treatment measure
BMS	BW003	No power sign	Battery capacity is low, and SOC is 0. Please charge the battery.
	BW004	Full power sign	When the full power sign is shown, and the battery SOC is 100, please stop charging.
	BW006	Discharging overcurrent alarm	Please reduce the load power.
	BW007	Charging overcurrent alarm	Please reduce the set charging power.
	BW008	Battery cell temperature difference alarm	Please stop charging and discharging.
	BW009	Cell voltage difference alarm	Calibrate charging
	BW010	MOSFET high-temperature alarm	Please stop charging and discharging.
	BW011	Charging and discharging low-temperature alarm	Please use below the ambient temperature specified in the manual.
	BW012	Charging and discharging high-temperature alarm	Please stop charging and discharging.
	BW013	Cell low-voltage alarm	The battery capacity is low, please charge the battery.
	BW014	Cell high-voltage alarm	The battery capacity is too high, please disconnect the power input.
	BW015	Overall voltage low-voltage alarm	The battery capacity is low, please charge the battery.
	BW016	Overall voltage high-voltage alarm	The battery capacity is too high, please disconnect the power input.
	BE004	Battery cell protection is invalid.	Send for repairs.
	BE006	Discharging overcurrent protection	Send for repairs.
	BE007	Charging overcurrent protection	Send for repairs.
	BE008	Short-circuit protection	Send for repairs.
	BE010	MOSFET high-temperature protection	Please stop charging and discharging.
	BE011	Charging and discharging low-temperature protection	Please use below the ambient temperature specified in the manual.
	BE012	Charging and discharging high-temperature protection	Please stop charging and discharging.
	BE013	Cell low voltage protection	The battery capacity is low, please charge the battery.
	BE014	Cell over-voltage protection	The battery capacity is too high, please disconnect the power input.
	BE015	Overall voltage low-voltage protection	The battery capacity is low, please charge the battery.
	BE016	Overall voltage over-voltage protection	The battery capacity is too high, please disconnect the power input.

Part	Prompt	Reason	Treatment measure
EMS	PCS offline!!!	Inverter communication fault	If the fault still exists after restart, repair and maintenance are recommended.
	MPPT offline!!!	MPPT communication fault	If the fault still exists after restart, repair and maintenance are recommended.
	BMS offline!!!	BMS communication fault	If the fault still exists after restart, repair and maintenance are recommended.
	System fault!!!!	Status switch fault	If the fault still exists after restart, repair and maintenance are recommended.
	Fan idling!!!	Fan idle speed	Repair and maintenance are recommended.
	CAN fault!!!	Inverter interruption fault	If the fault still exists after restart, repair and maintenance are recommended.



Shenzhen Xihe Future Technology Co.,Ltd.



Please scan this QR code for more product information