



## TM22VK Mercedes A Class / A Class Sal / B Class / CLA / CLA Shooting Brake / GLA / GLB

Item	Qty	Description	Item	Qty	Description
A	1	TM22 Crossmember	D	1	Flip Up Socket Plate (TTFP/LH)
B1	1	L/H Side Arm	E	2	M12 x 35 Bolts & S/P Washers
B2	1	R/H Side Arm	F	4	M10 x 35 Bolts & Nyloc Nuts
C	1	6201 Detachable Neck	G	2	M12 x 25 Bolts & S/P Washers
			H	2	M12 x 22 Bolts & S/P Washers
			J	2	12 x 30 Flat Washers
			K	8	10 x 25 Flat Washers
			L	4	12 x 25 Flat Washers
			X	6	Original M10 Flange Nuts

### BUMPER REMOVAL:

1. Remove boot interior floor, side panels and rear kick plate, this will allow access to remove two fixings through the rear panel securing the bumper. Remove the rear light clusters, three fixings in boot area per light. Remove nine fixings from the bumper lower edge, two fixings from the bumper lower edge tabs, four fixings from each wheel arch, peel back wheel arch liner to reveal one tip fixing either side. GLB / GLA will require wheel arch trim to be released from bodywork.
2. Remove rear impact beam (This is not refitted with the Towbar assembly, retain nuts (Item X) for fitting Item A).
3. Cut the rear bumper / under try as per the sketch on page 2.

### TOWBAR INSTALLATION:

1. Using the original Nuts (Item X) loosely fix Item A to the rear panel. Always fully seal the rear panel and chassis openings with a suitable sealant to prevent water ingress.
2. Inserts Items B into each correct chassis and secure in place using Item E and Item J.
3. Fix Items B to Item A using Items F with Items K.
4. Using Item G with Item L and Item H with Item L fix Item C and Item D to Item A.
5. Fully tighten all fixings ensuring the Towbar is rigid, square and secure.
6. Refit the rear bumper, light clusters and interior trim.

Before cutting any of the rear bumper locate the keyless entry sensor and ensure you do not cut through.

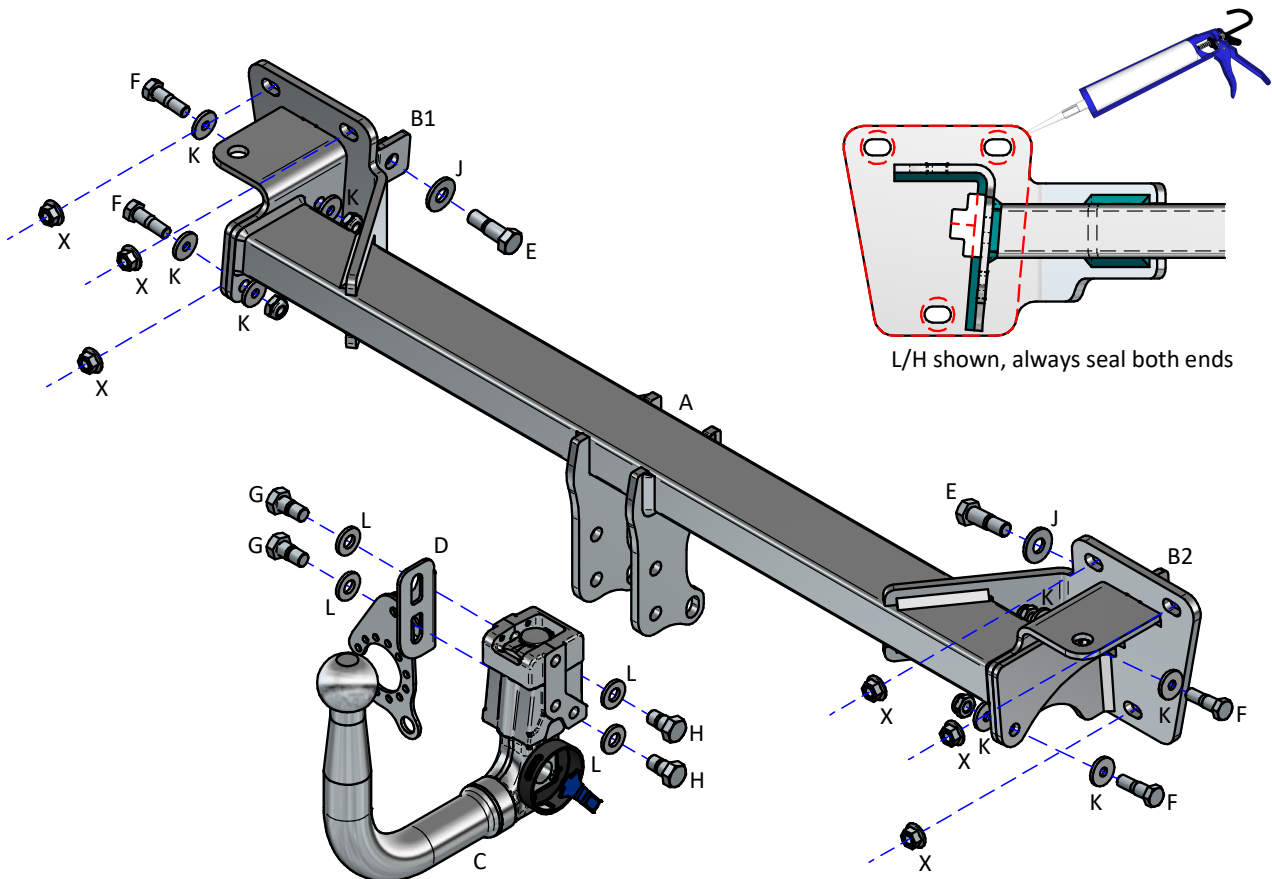

### Notes:

1. For Torque settings see general notes overleaf.
2. Nose load limits and vehicle manufacturer's trailer / caravan weight limits must be observed.

A/B Class Bumper Cut

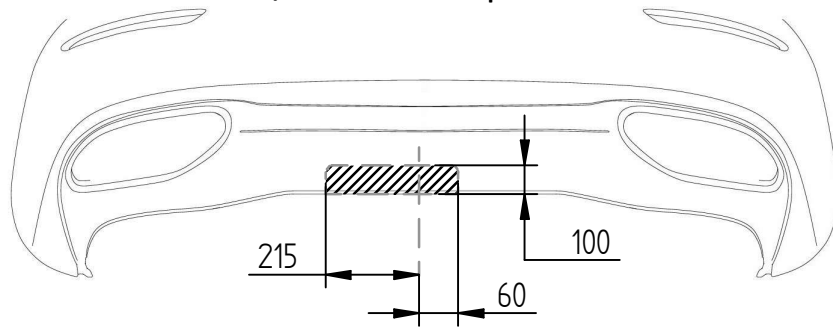

A/B Class AMG Line Bumper Cut

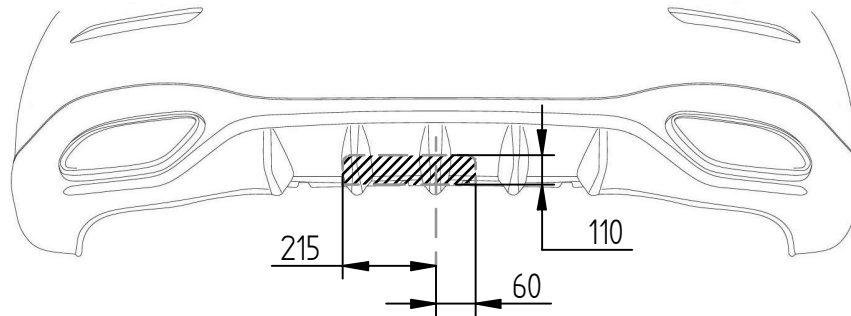

A Class Sal AMG Line Bumper Cut

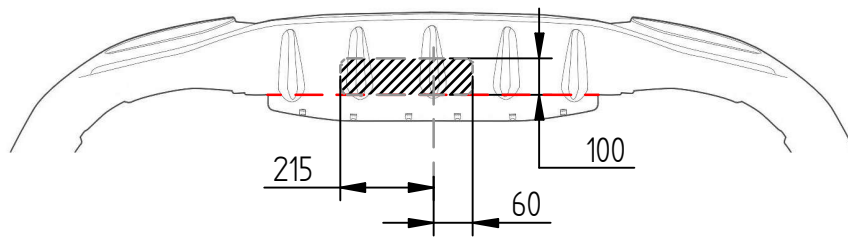

CLA Under Tray Cut

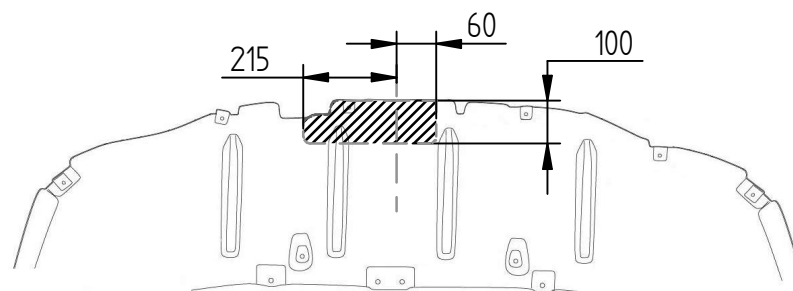

GLA / GLB Bumper Cut

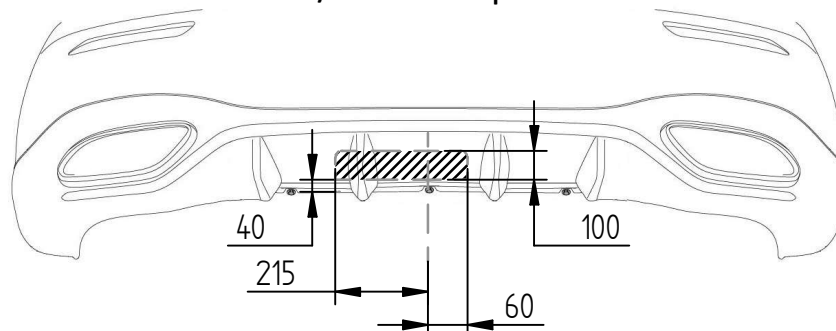

All models may require bumper cuts to be trimmed to suit each variant  
Before cutting any of the rear bumper locate the keyless entry sensor and ensure you do not cut through.