

Ford C-MAX II 07/2010-
Ford Focus Sedan 01/2011-
Ford Focus Hatchback 01/2011-

Partnr.: FR-063-B1U

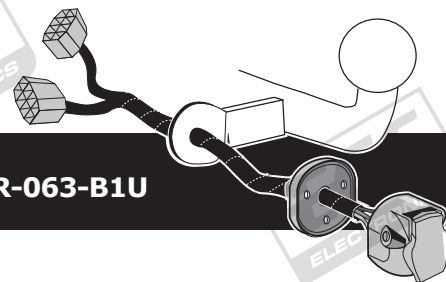

- Fitting instructions electric wiring kit tow bar with 12-N socket up to DIN/ISO Norm 1724.
- We would expressly point out that assembly not carried out properly by a competent installer will result in cancellation of any right to damage compensation, in particular those arising by virtue of the product liability act.
- Contents of these kits and their fitting manuals are subject to alteration without notice, please ensure that these instructions are read and fully understood before commencing installation.
- Do not overload circuits; the maximum loads per connection are detailed in this manual.
- Attention! Before Installation, please read this manual carefully and inform your customer to consult the vehicle owners manual to check for any vehicle modifications required before towing.
- In the event of functional problems, troubleshooting must be limited to about 0.5 hours, contact the technical support:
t.skinner@ecs-electronics.com / 07440 202 052.

TECHNICAL SUPPORT

CALL
07440
202
052

ECS ELECTRONICS
MONDAY TO FRIDAY
08.00 - 11.00 am
12.00 - 05.00 pm
t.skinner@ecs-electronics.com
www.ecs-electronicsuk.co.uk

Part list

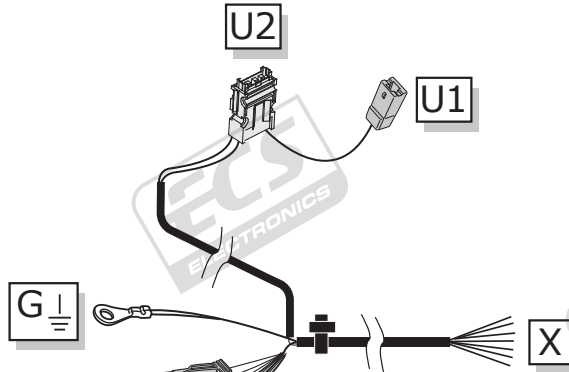
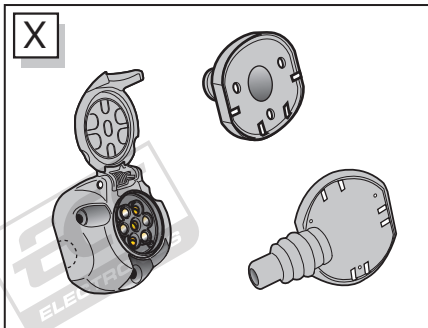
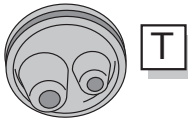
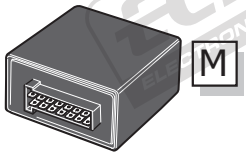
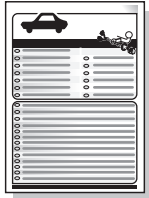
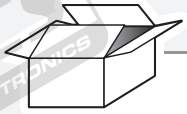

Optional
FR-050-YZ & UN-094-YZ

Pag. 14

UN-243-YZ
Optional reverse lamp
pre-wire extension included

Pag. 19

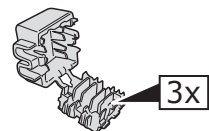
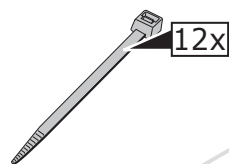
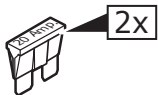
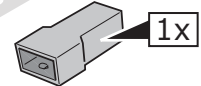
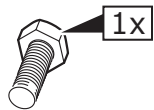
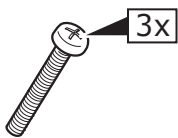
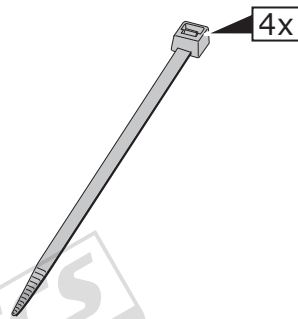

ROUTING

C-Max II

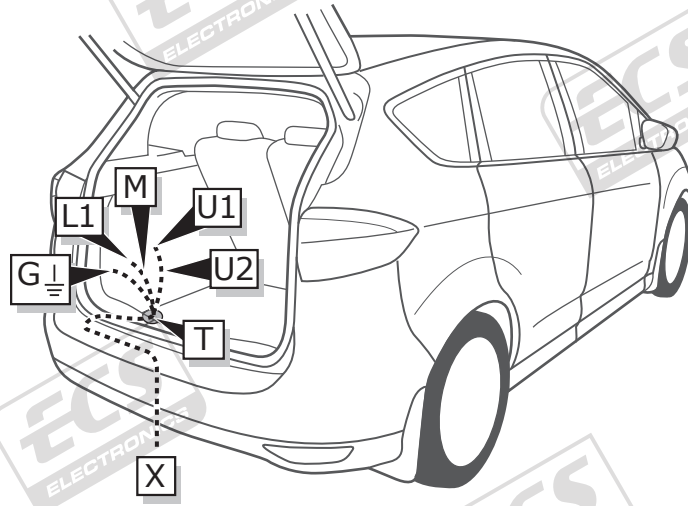

Focus Sedan

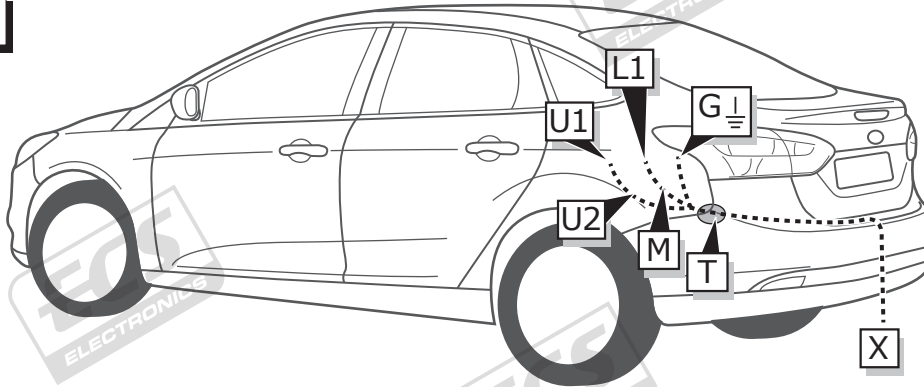

Focus Hatchback

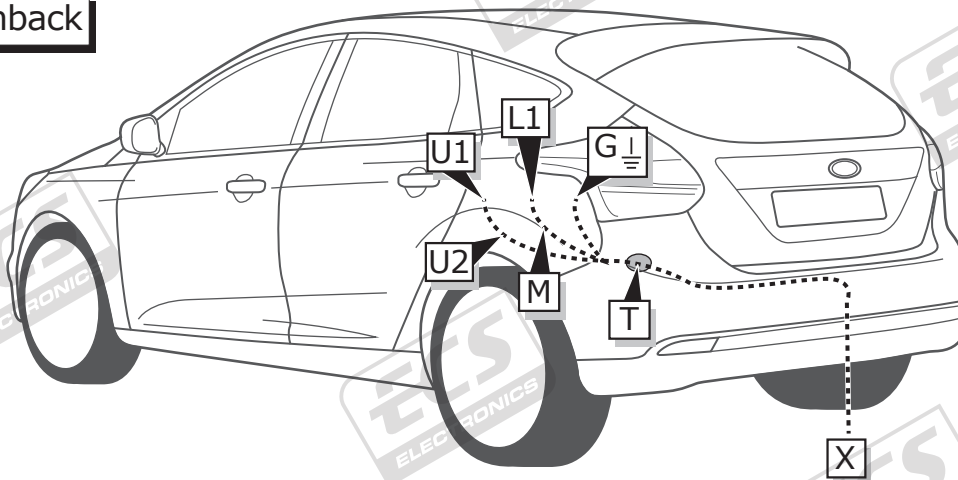

1

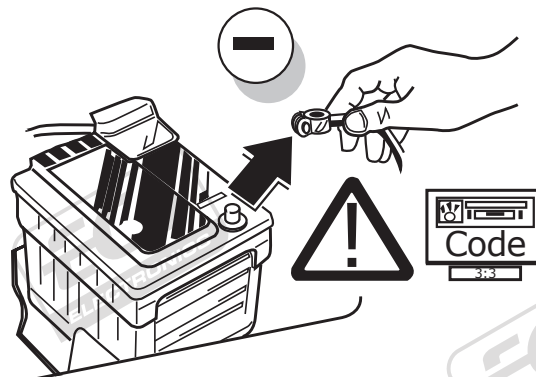

2

C-Max II

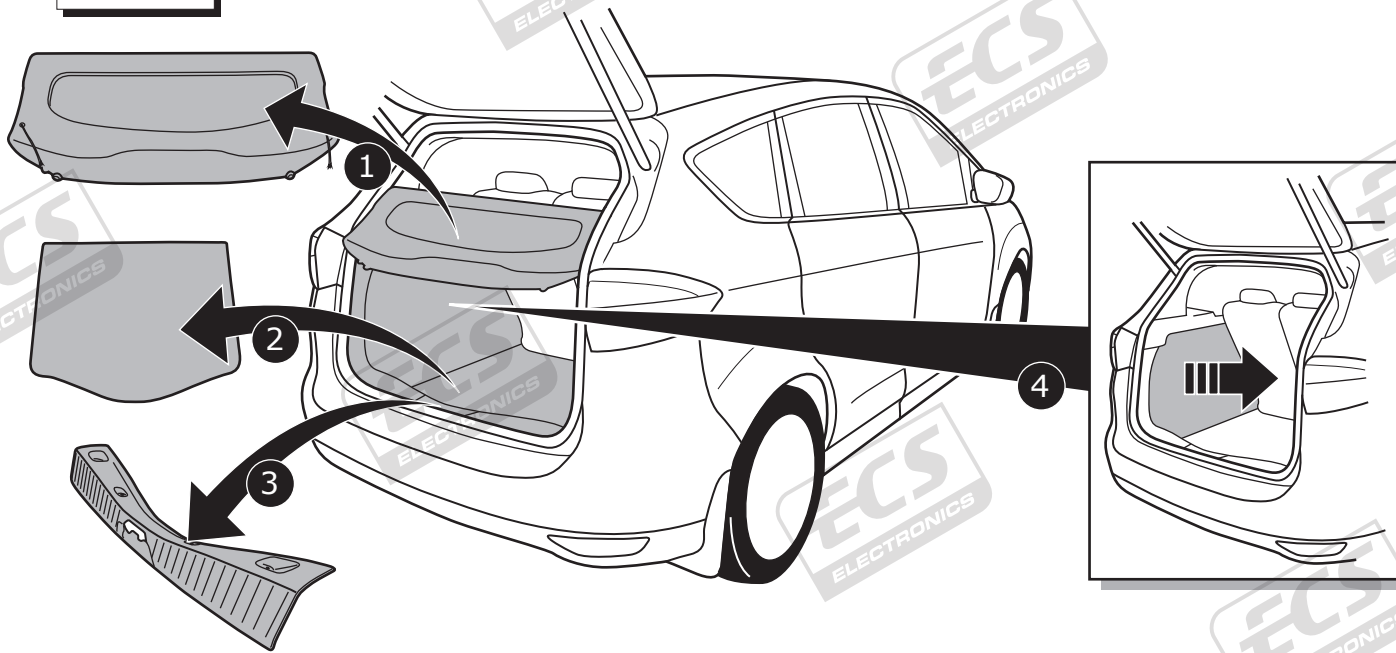

3

Focus Sedan

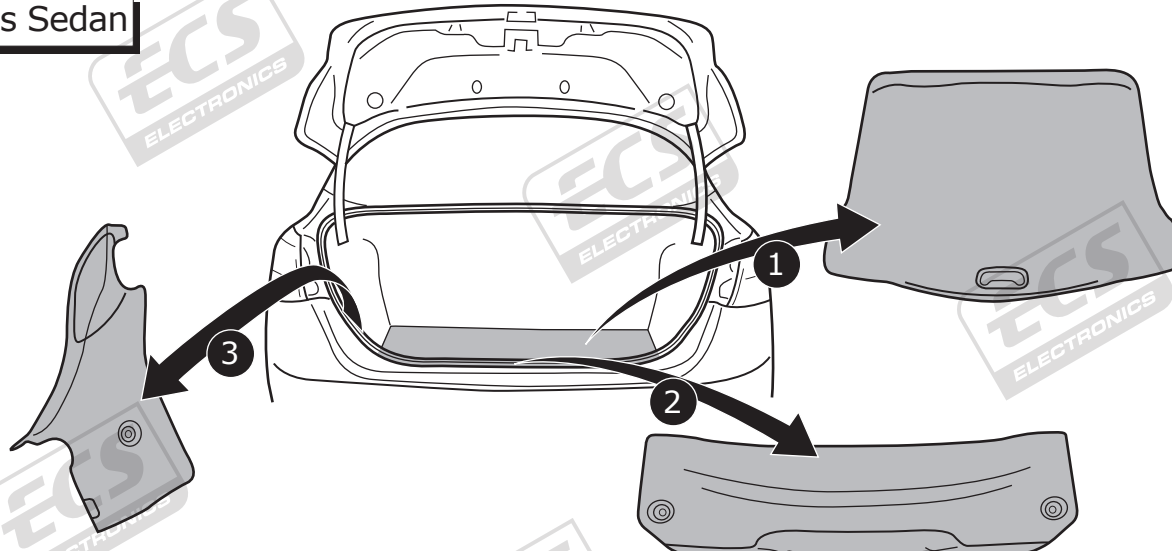

4

Focus Sedan

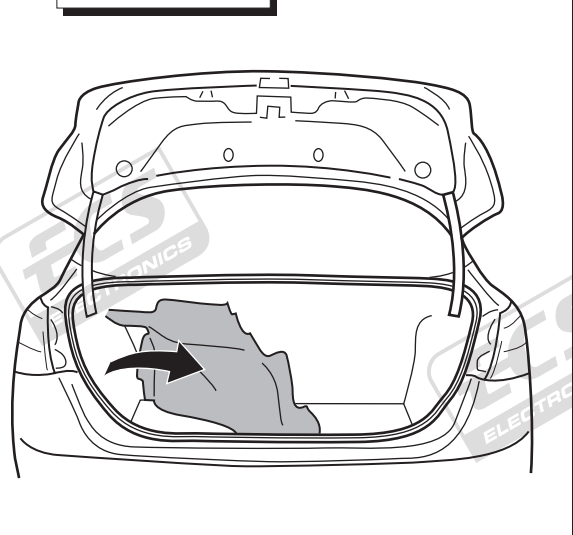

5

Focus Hatchback

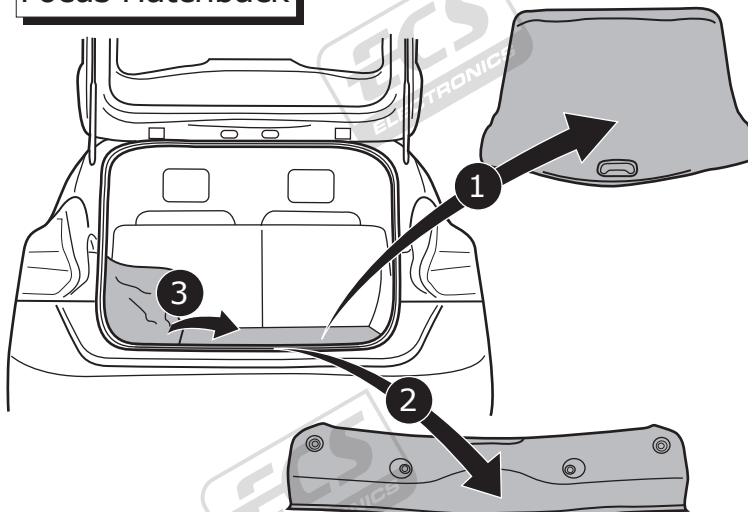

OPTION 1

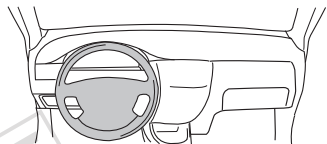

C-Max II LHD

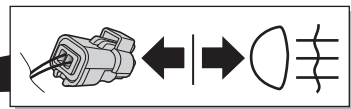
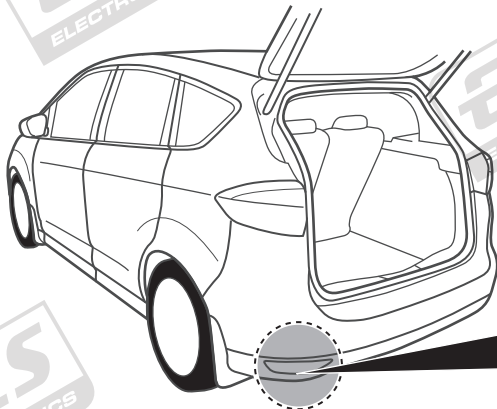

1

2

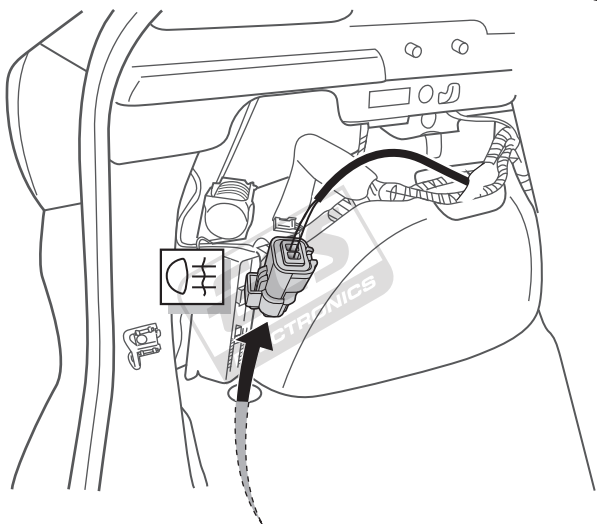

4

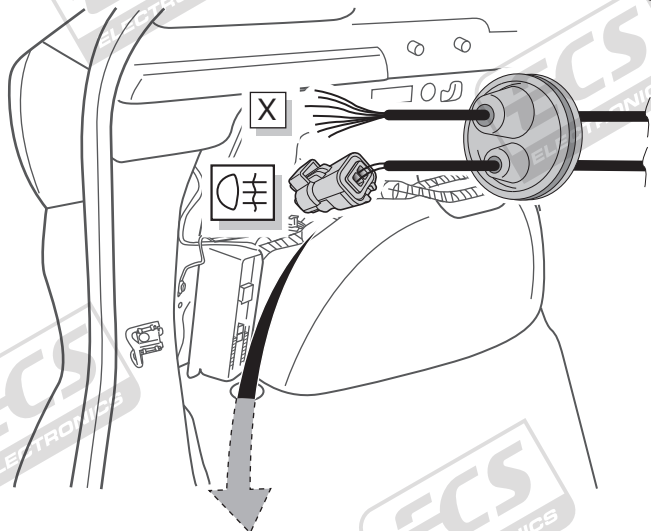

3

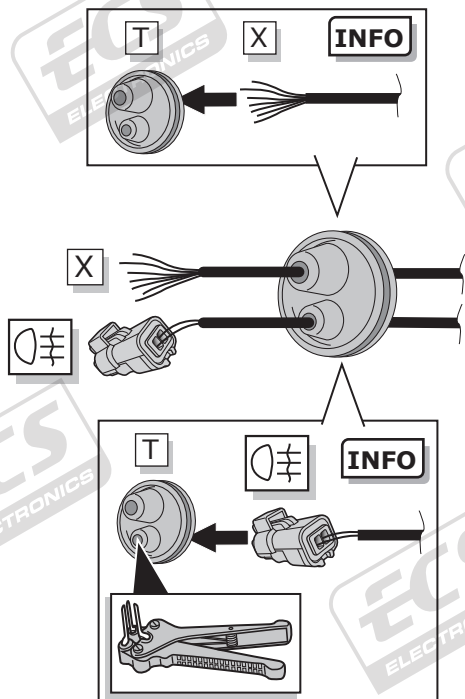

5

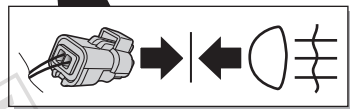
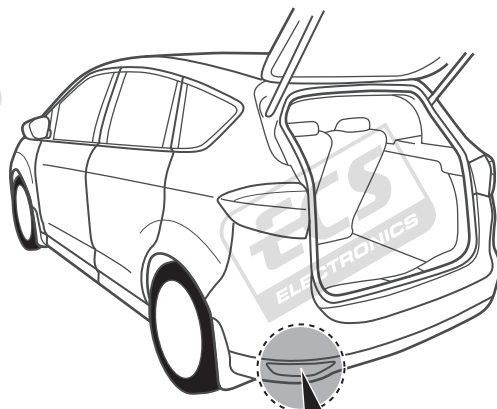

OPTION 2

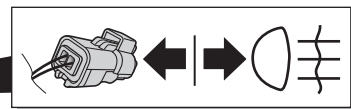
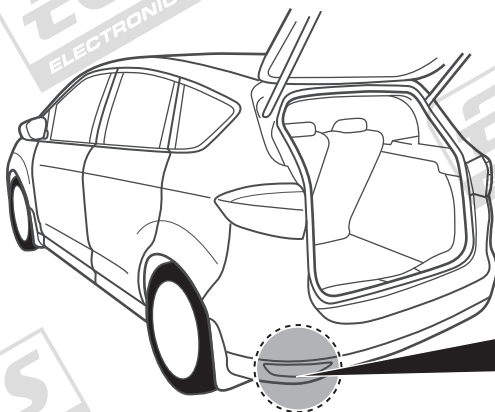
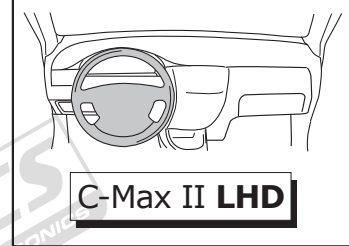

1

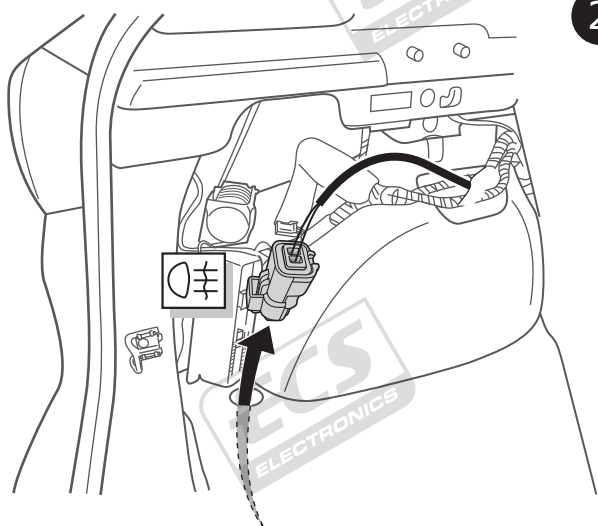

2

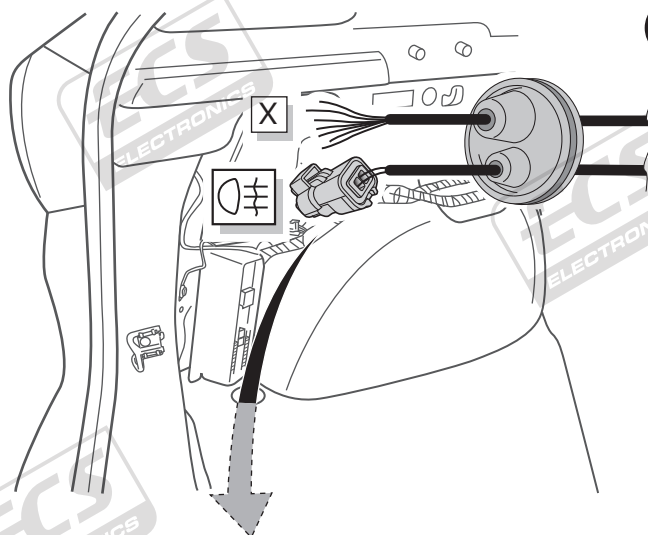

5

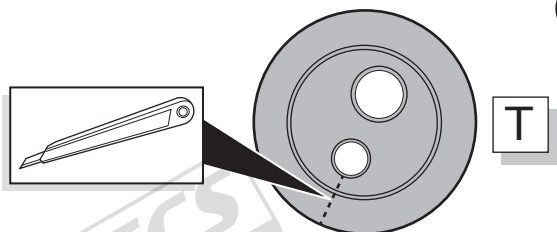

3

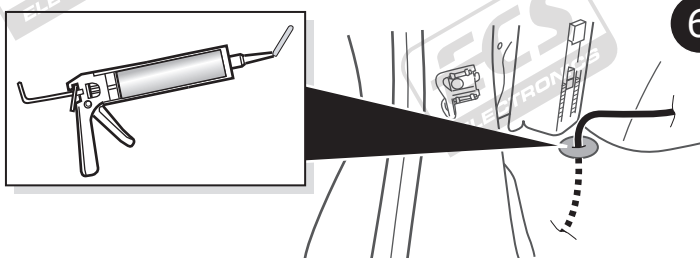

6

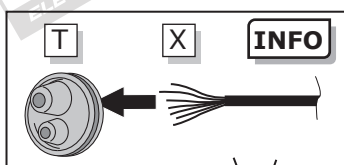

4

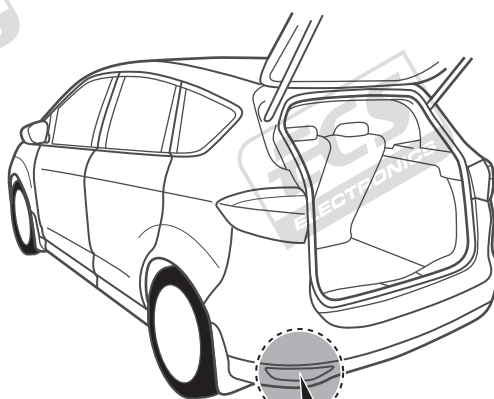

7

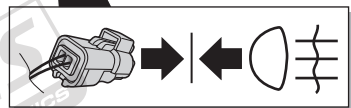
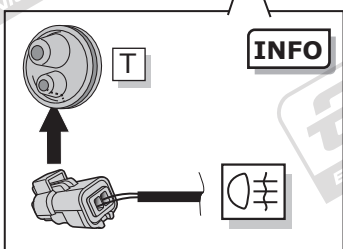
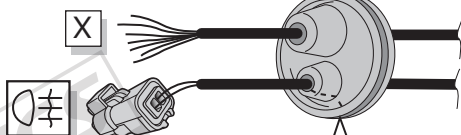

OPTION 3

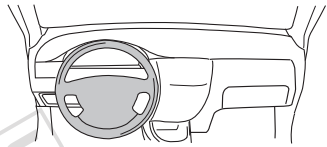

C-Max II LHD

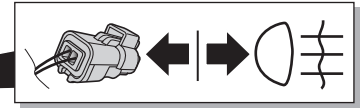
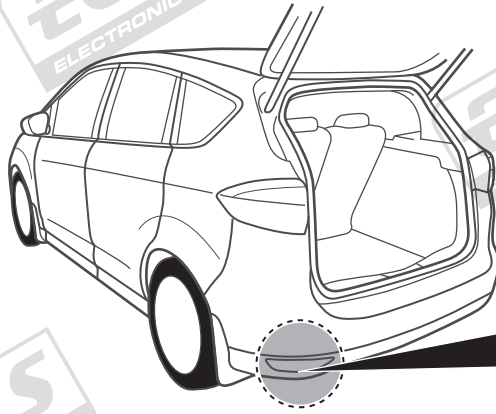

1

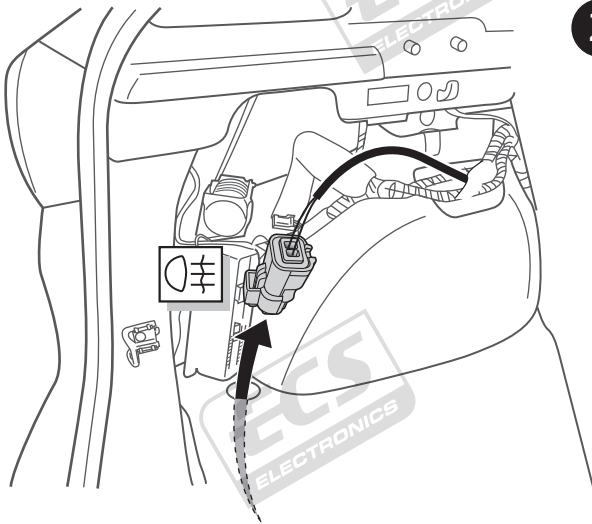

2

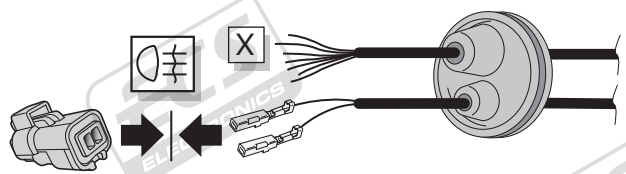

5

!	Pos. 1		
	Pos. 2		

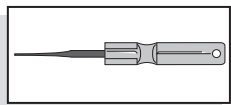

3

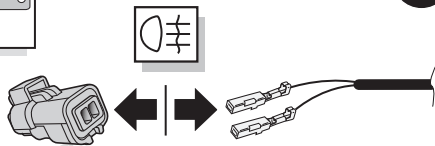

Pos. 1		
Pos. 2		

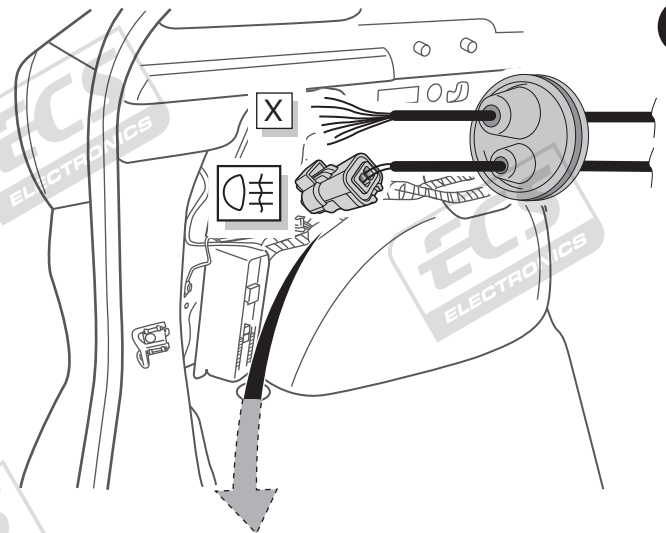

6

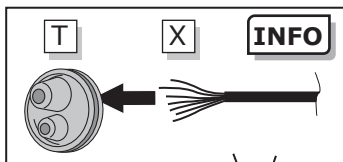

4

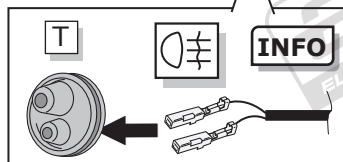
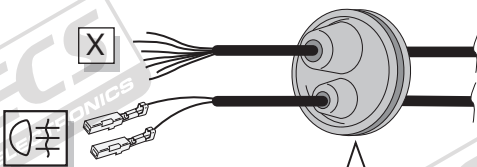

7

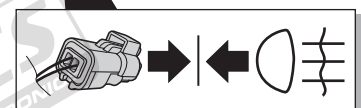
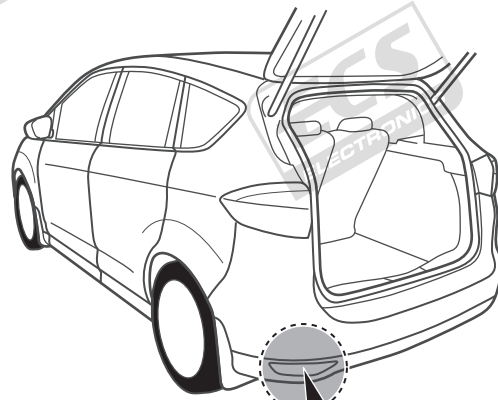

OPTION 4

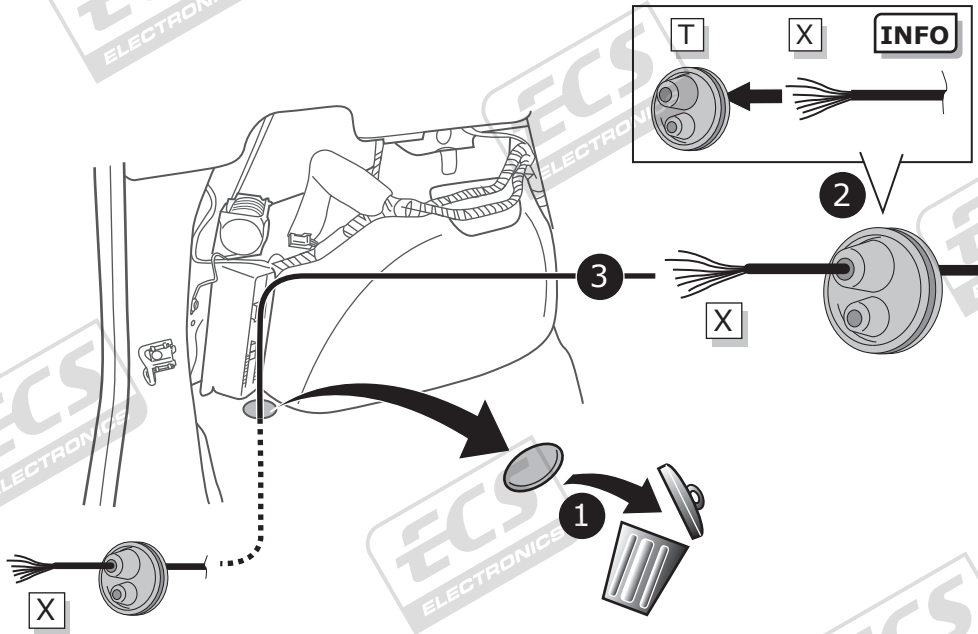
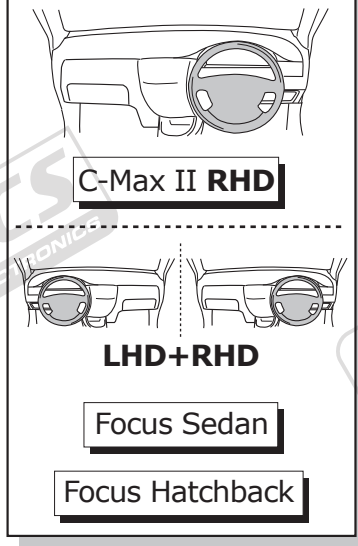

A

Option 1

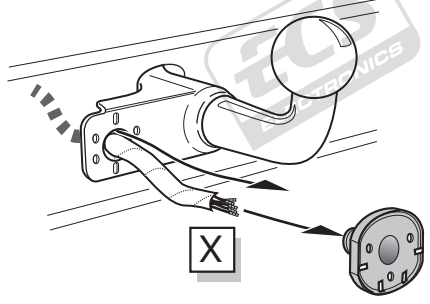

Option 2

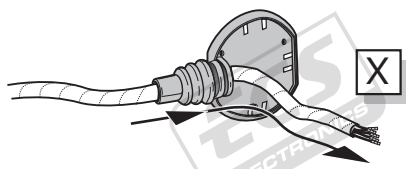

Option 3

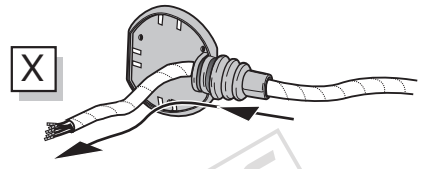

INFO

SOCKET CONNECTION 

Pag. 13

B

Option 1

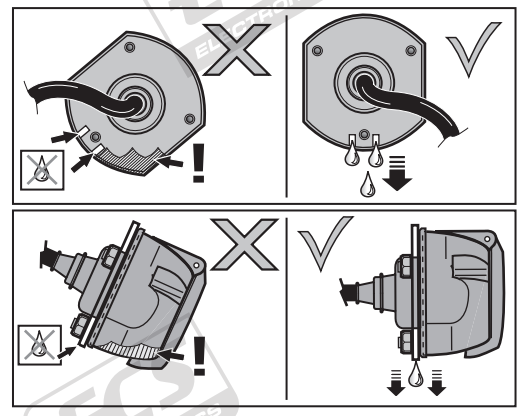
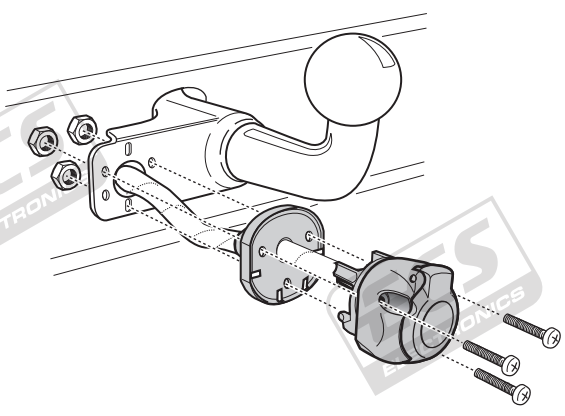

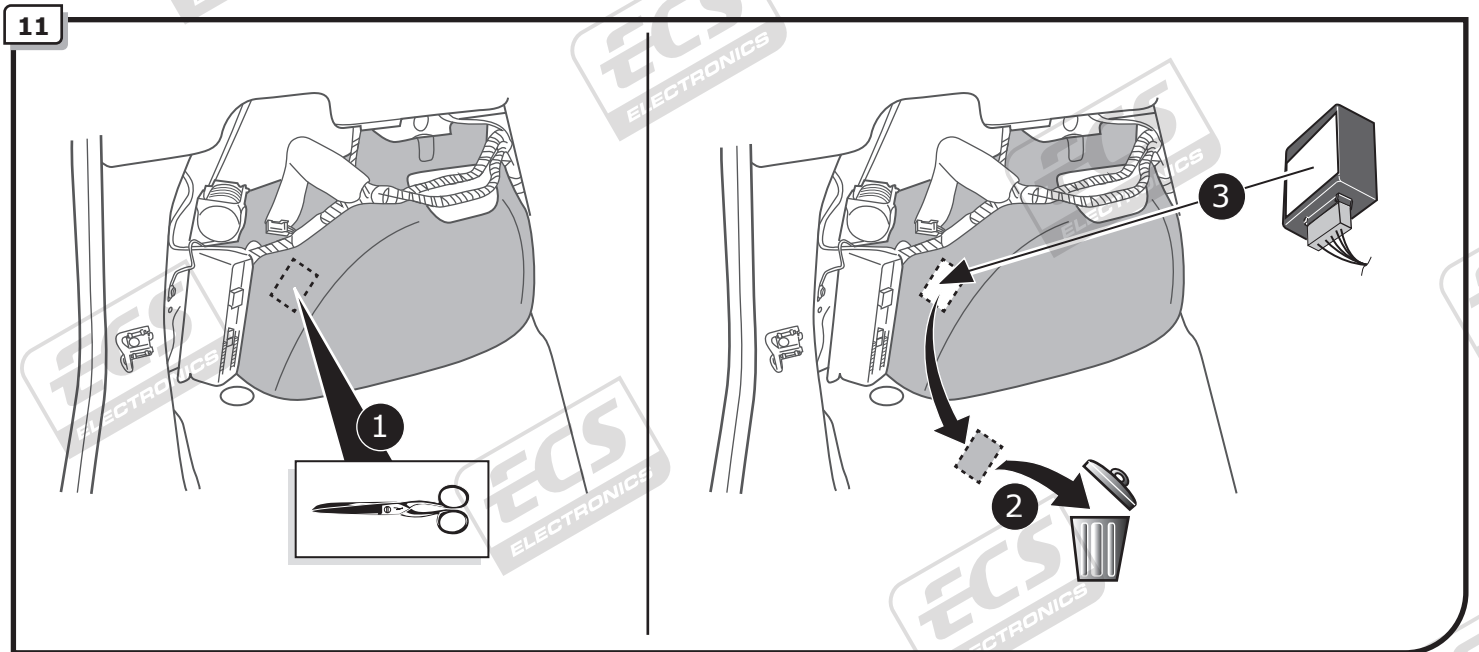
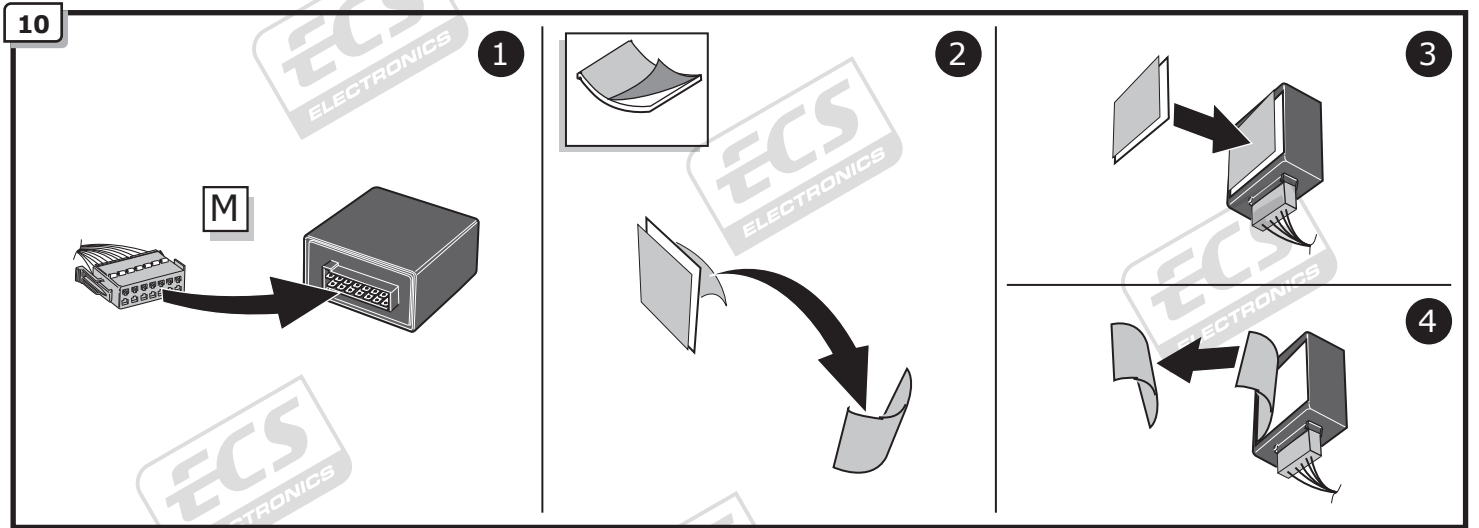
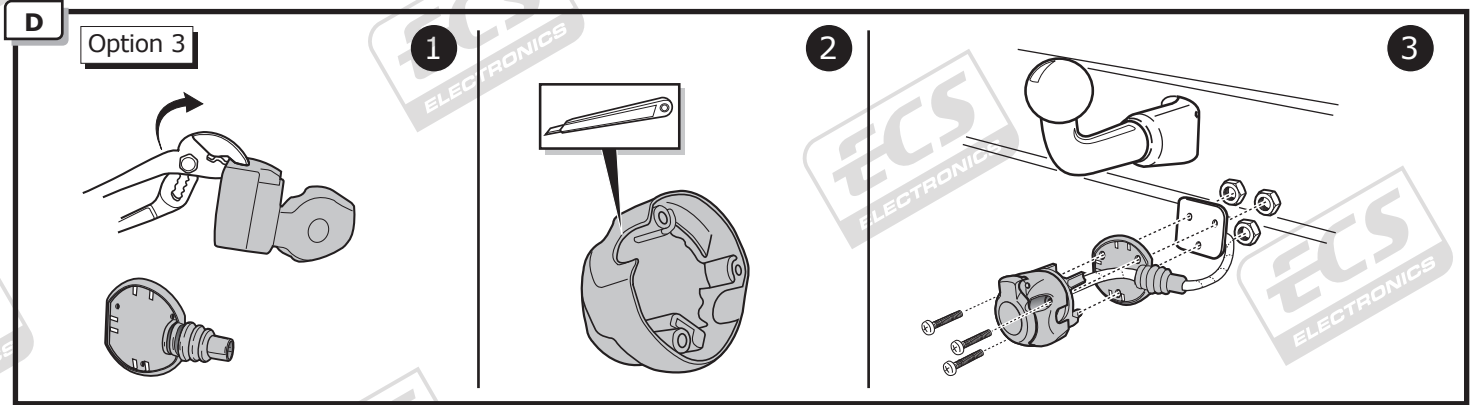
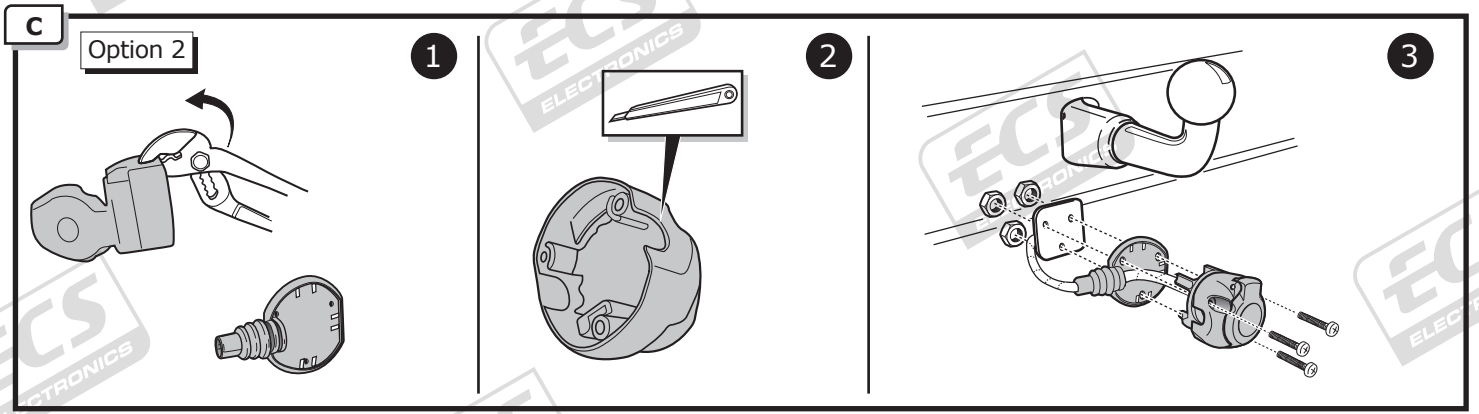

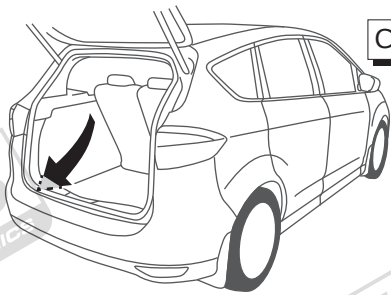

C-Max II

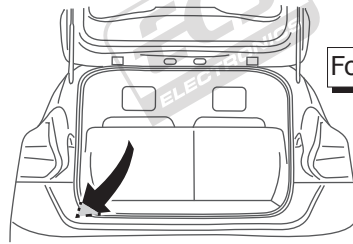

Focus Hatchback

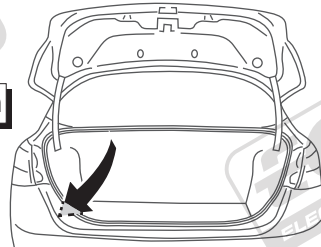

Focus Sedan

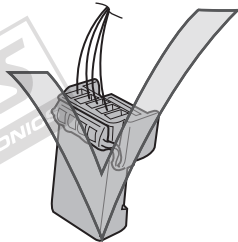
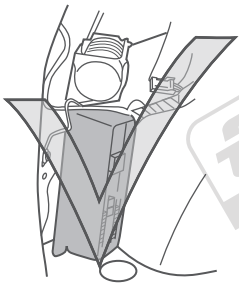

12

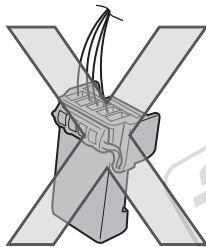
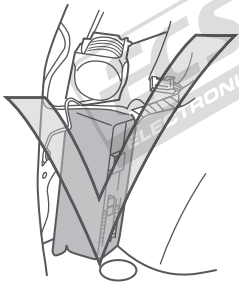

Optional
FR-050-YZ & UN-094-YZ

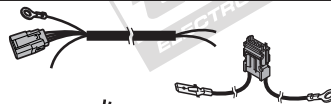

Pag. 14

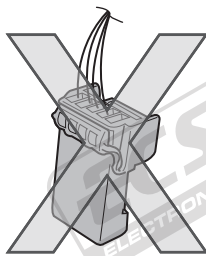
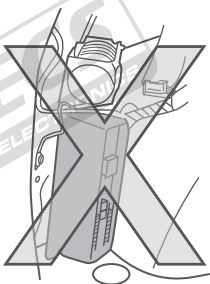

12

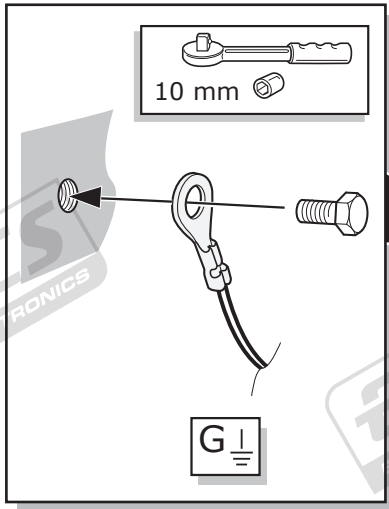

2

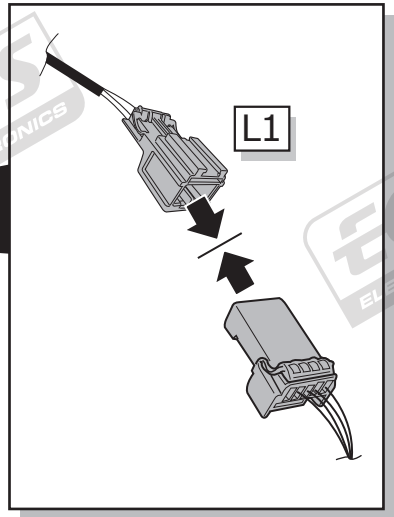
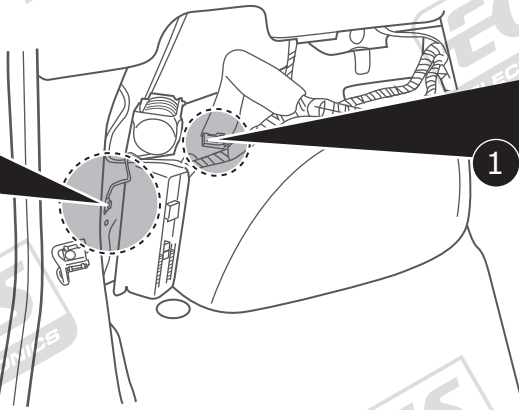

13

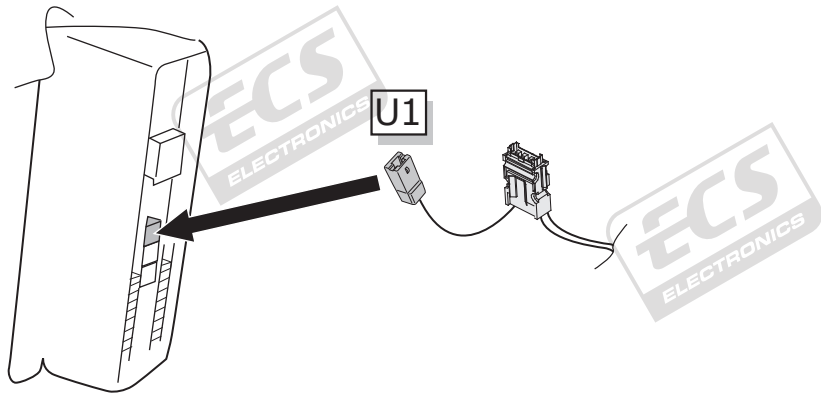
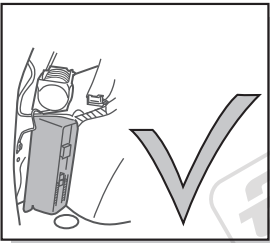

14

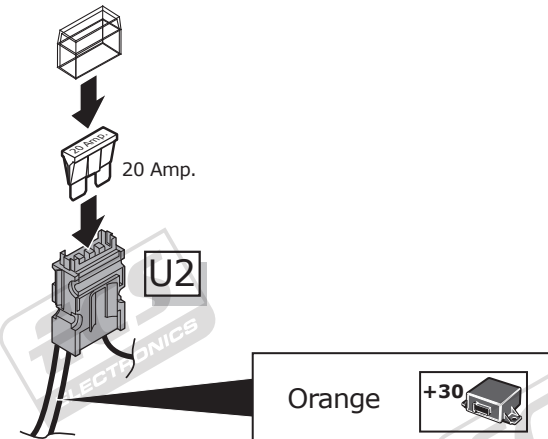

15

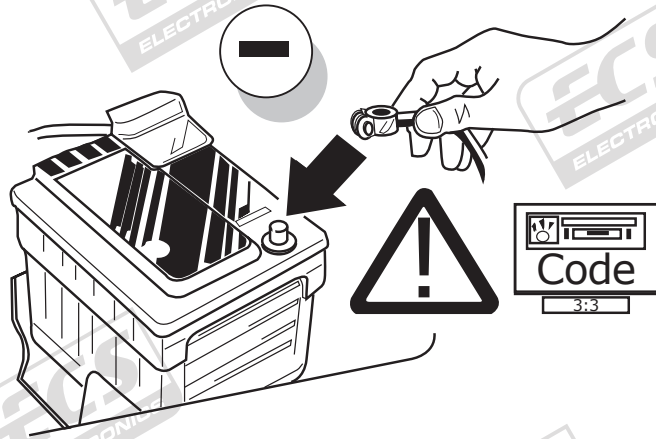

16

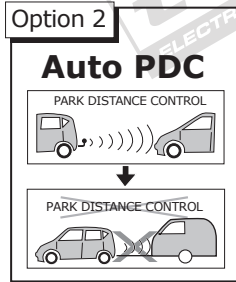
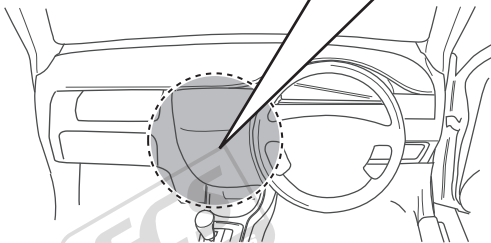
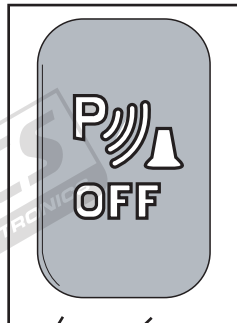
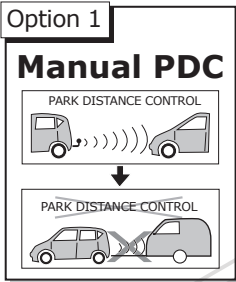

Parameter 20
Parameter 76



17



TEST ALL THE CIRCUITS WITH A TEST DEVICE WITH THE CORRECT POWER LOAD FOR EACH FUNCTION. A TEST DEVICE WITH LED'S CANNOT BE USED FOR THIS PURPOSE.

INFO

REINSTALL TRIM.

18

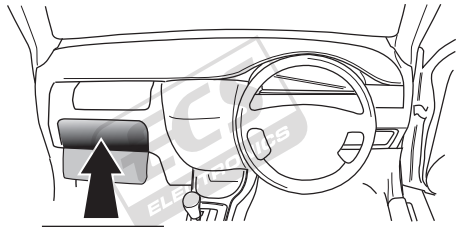

User guide



INFO

SOCKET CONNECTION

DIN/ISO 1724							
	1/L	2	3/31	4/R	5/58-R	6/54	7/58-L
Pmax	21W	21W		21W	42W	3x21W	42W
Colour	Yellow	Blue	White	Green	Brown	Red	Black

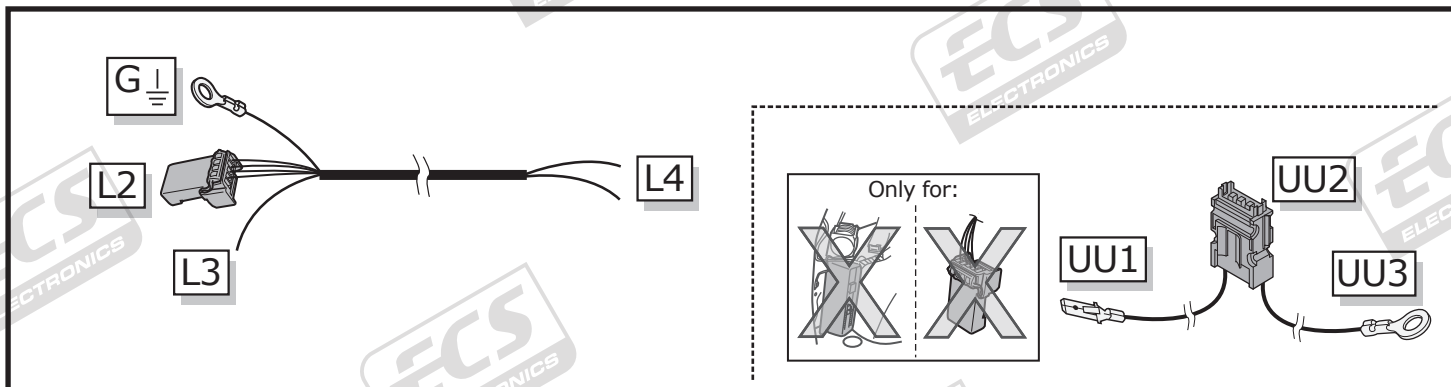

ROUTING

C-Max II: option 1

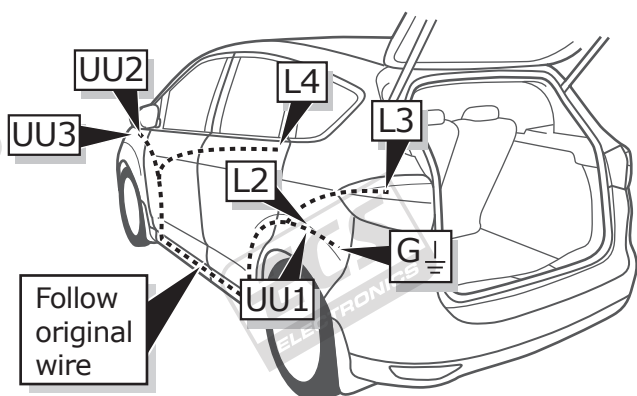

C-Max II: option 2

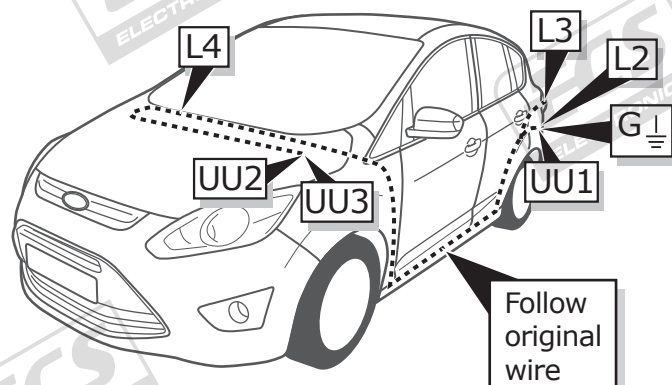

Focus Sedan: option 1

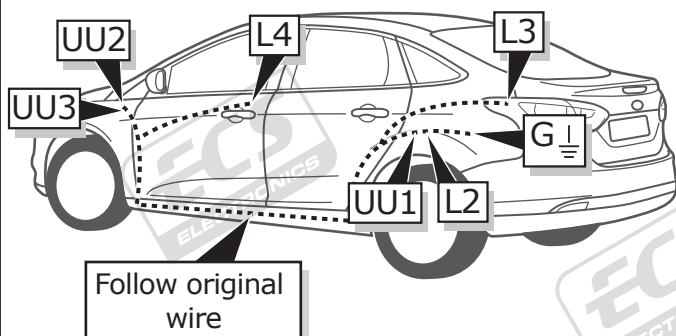

Focus Sedan: option 2

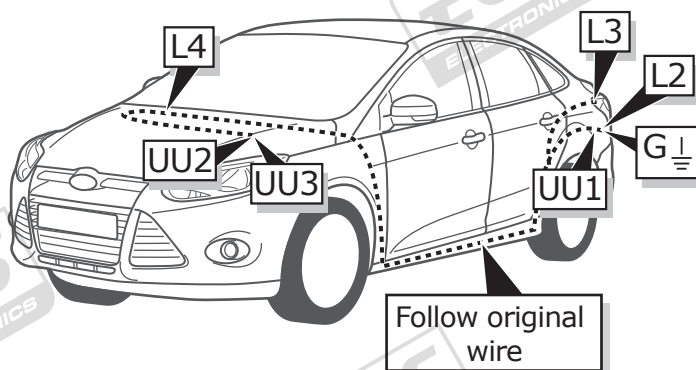

Focus Hatchback: option 1

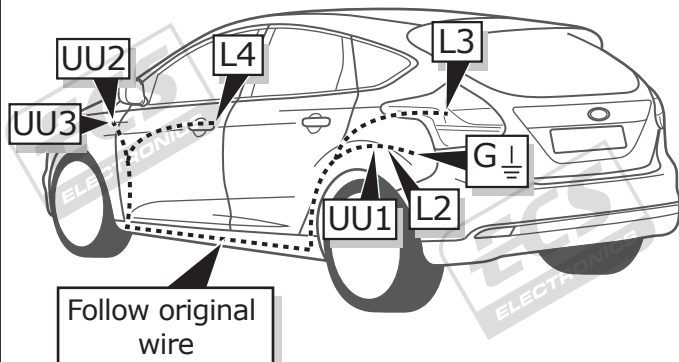

Focus Hatchback: option 2

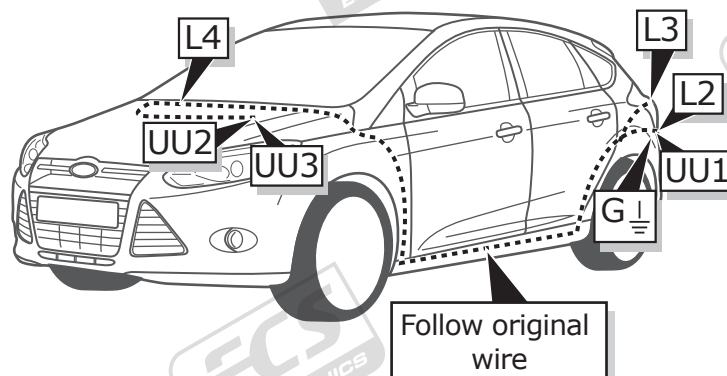

A

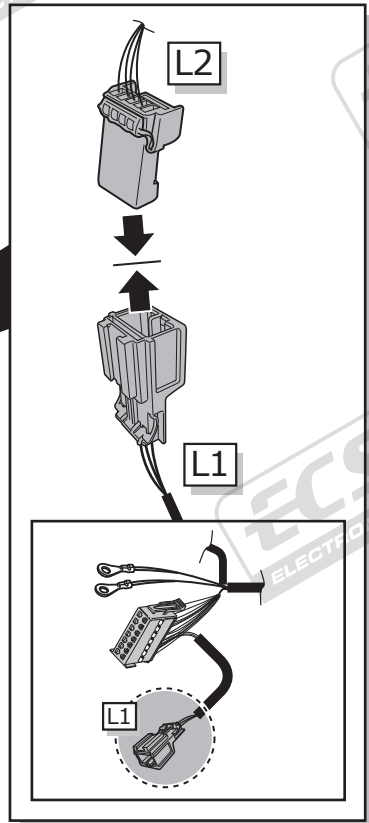
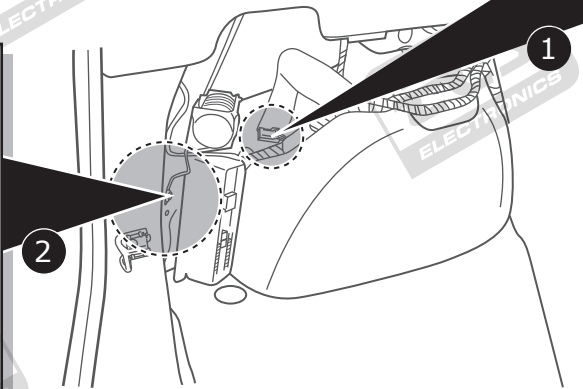
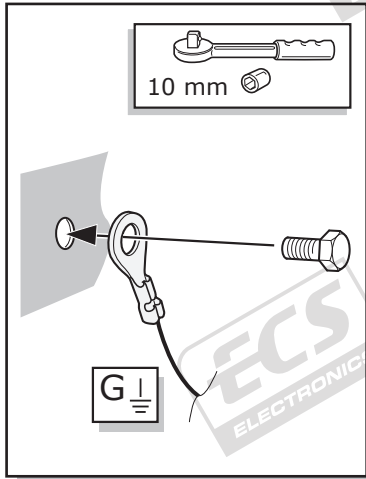
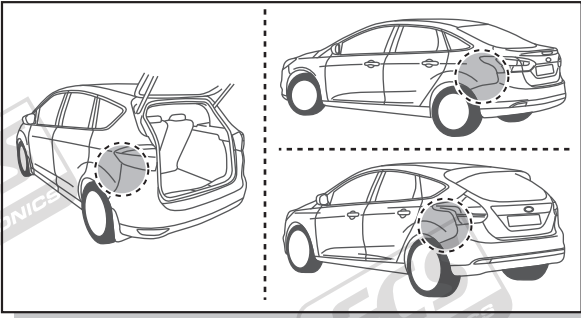

B

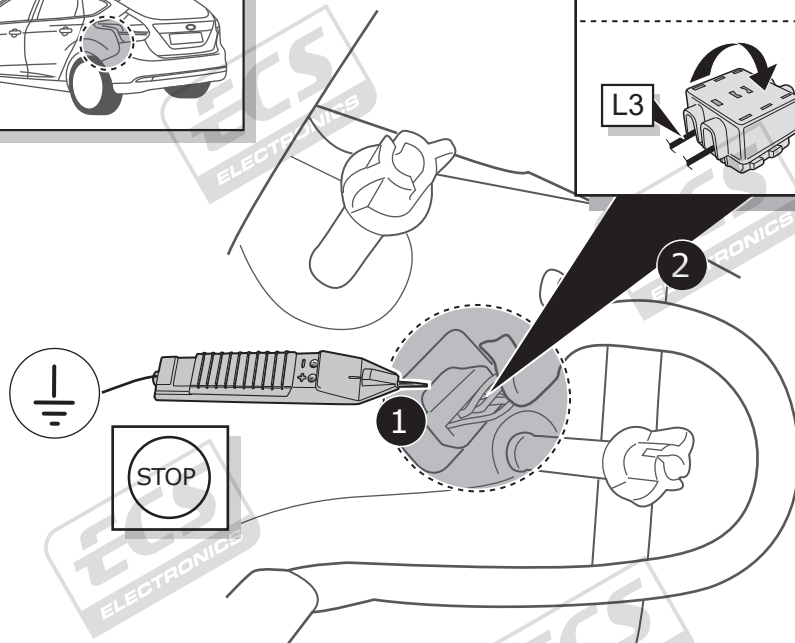
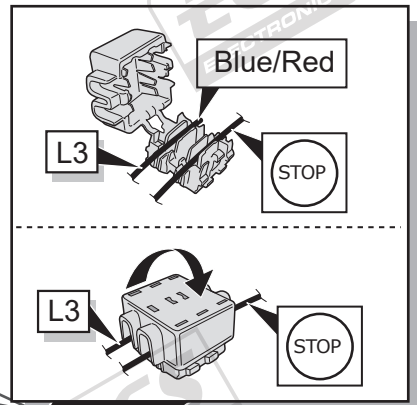
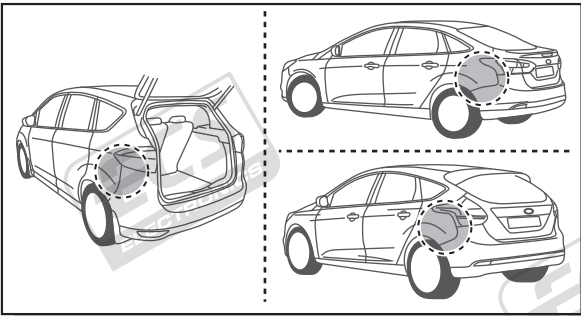



C

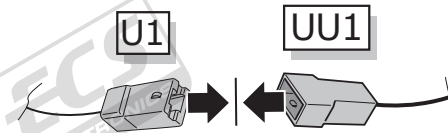
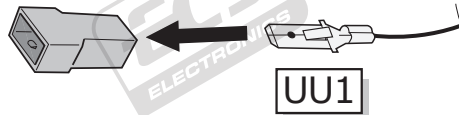
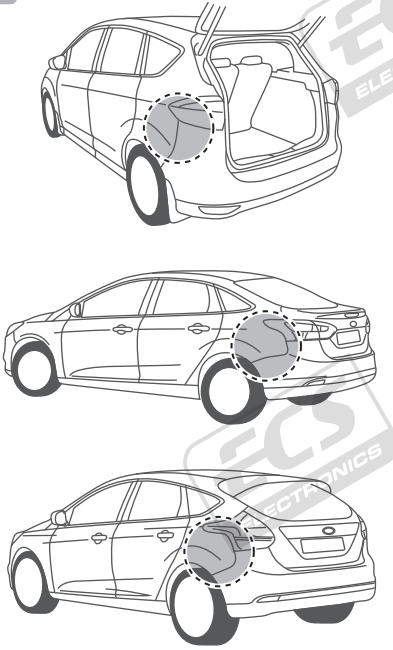

D

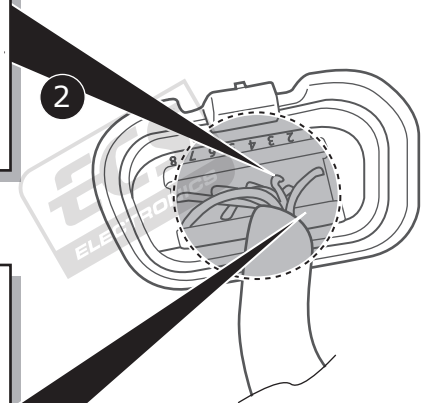
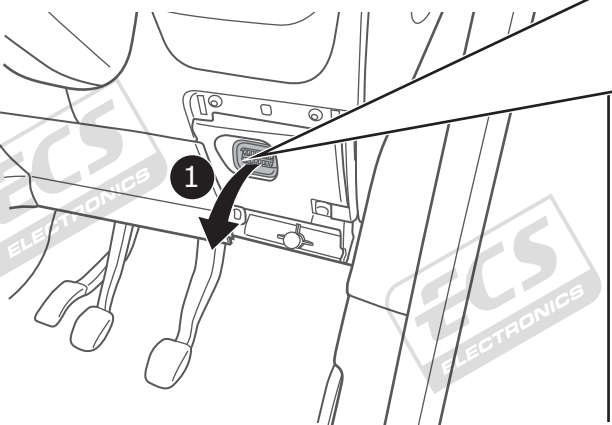
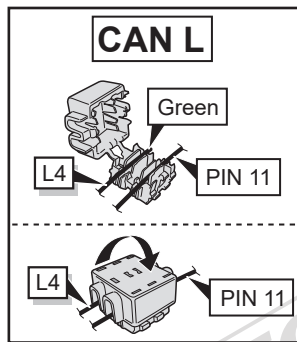
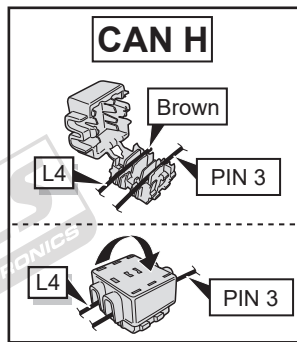
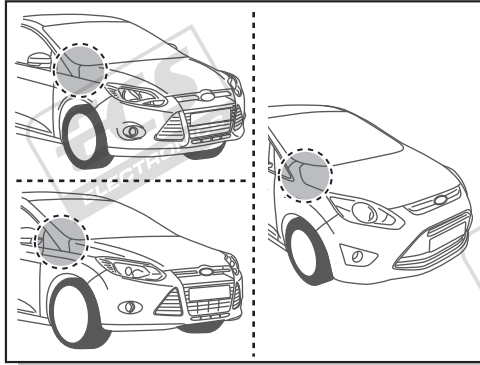

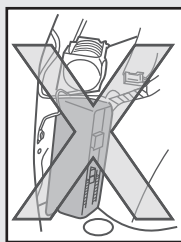

E

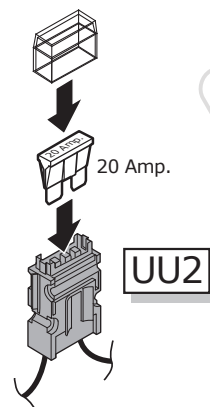
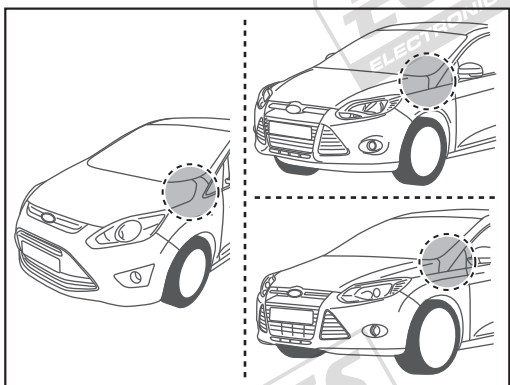

F

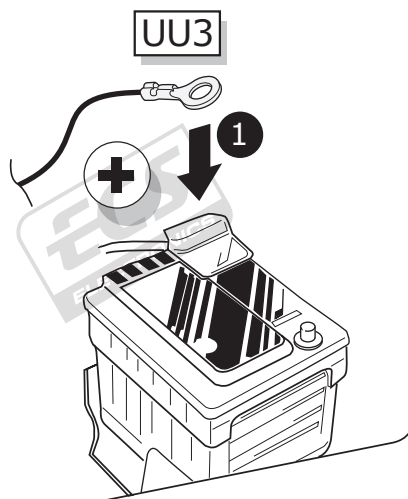

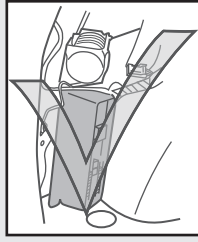

G

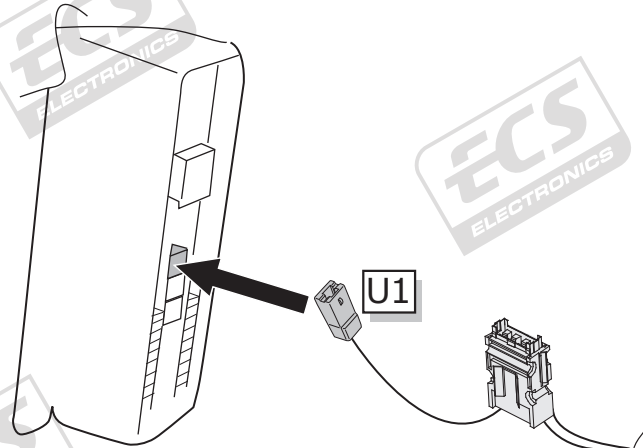

H

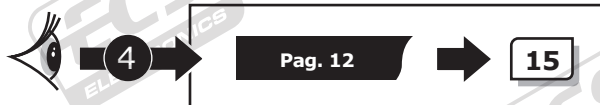
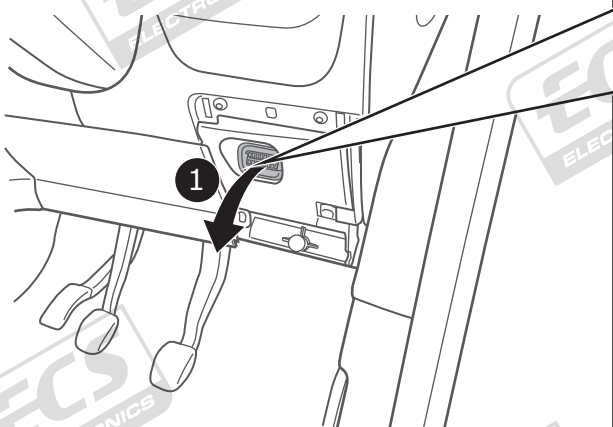
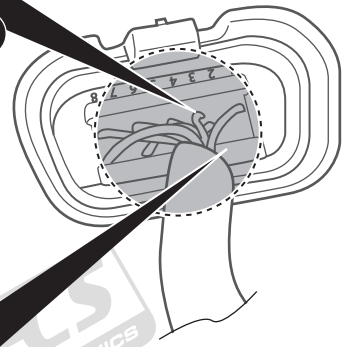
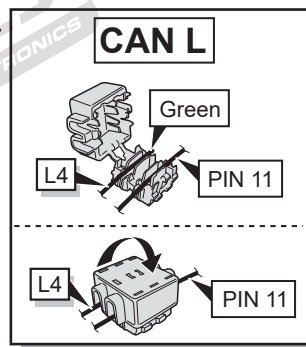
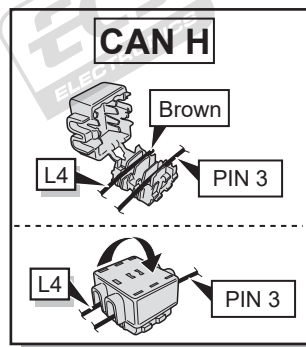
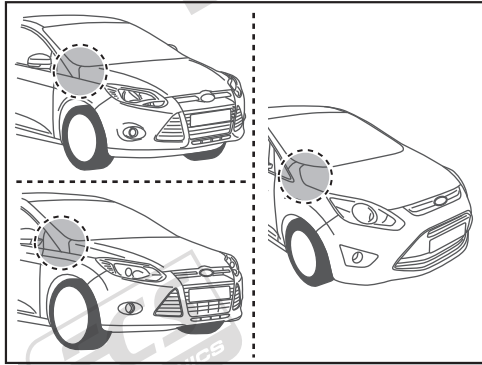

UN-243-YZ Reverse lamp pre-wire extension

⚠ MAX = 21W

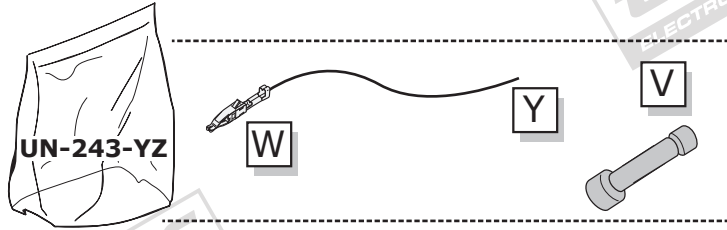

A

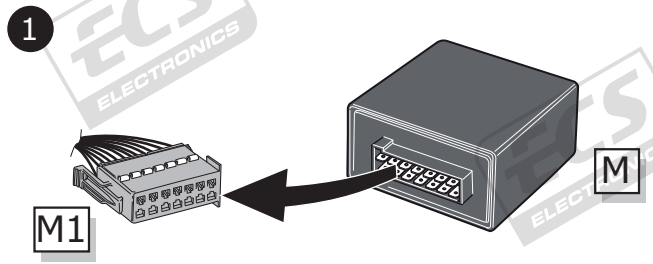
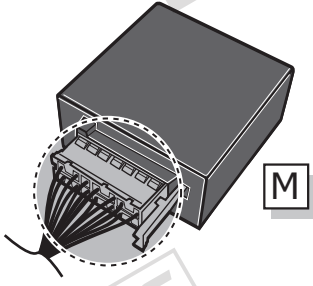

2

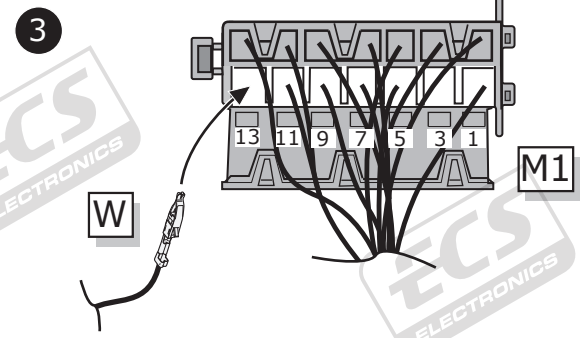
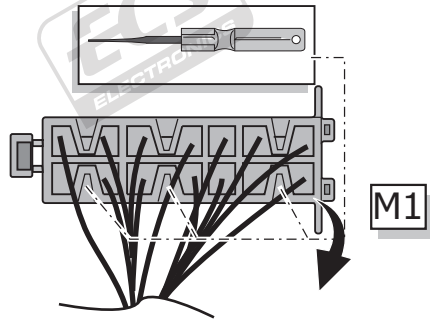

4

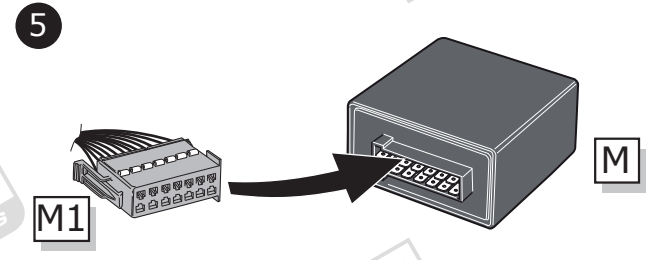
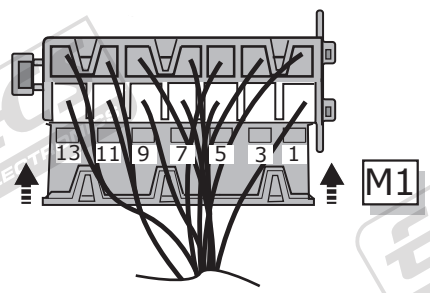

B

⚠ MAX = 21W

