



**MEDIC  
THERAPEUTICS**

---

# **ADJUSTABLE LAPTOP DESK**

**WITH COOLING PAD & MOUSE PAD**

---



## **User Manual**

To avoid injury, please read all manual instructions carefully prior to use.

## MEDIC THERAPEUTICS ADJUSTABLE LAPTOP DESK WITH COOLING PAD & MOUSE PAD

Made with light, premium aluminum alloy- the Adjustable, Foldable Cooling Laptop Stand has been built to last for many, many years to come. Equipped with fans for immediate heat dissipation, the stand has been specifically designed for easy adjustment for maximum comfort.

### PARTS LIST

- 1x Laptop Stand
- 1x Mouse Tray
- 1x Washer
- 1x Star Knob
- 2x Edge Stopper
- 1x USB Cable

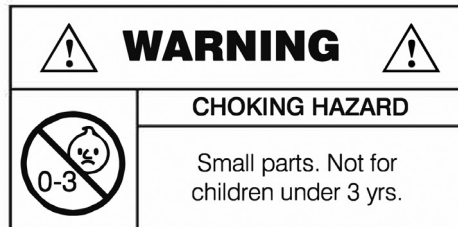

### TERMINOLOGY

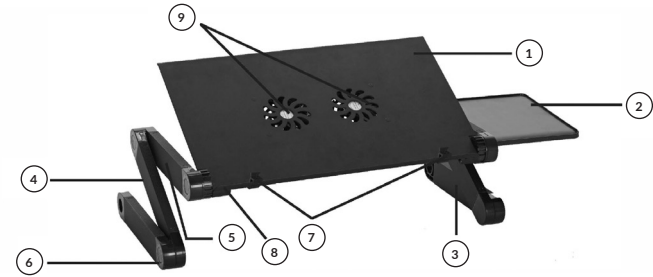

①	Laptop Tray	⑥	Pivot Joint
②	Mouse Tray	⑦	Edge Stopper
③	Lower Leg	⑧	Front Lip
④	Middle Leg	⑨	Cooling Fans
⑤	Upper Leg		

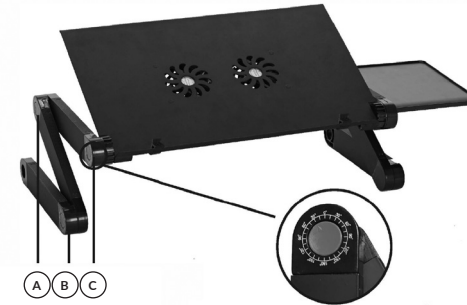

Pivot Joint (A) Angle Measurements  
 Pivot Joint (B) Arrow on the button indicates the angle reached  
 Pivot Joint (C)

### NOTICE: LOCKING STATES



Button in  
Not Locked yet



Button out  
Locked

## UPFOLDING THE LAPTOP STAND

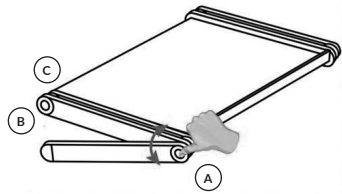

**Step 1:**  
Press and hold the button on Joint A to rotate the lower leg until it reaches the desired angle. The button will bounce back out if the lower leg has been locked in place.

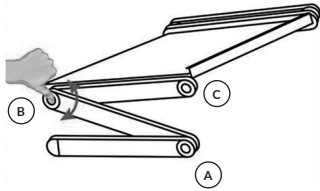

**Step 2:**  
Press and hold the buttons on Joint B to rotate the middle leg until it reaches the desired angle. The button will bounce back out if the middle leg has been locked in place.

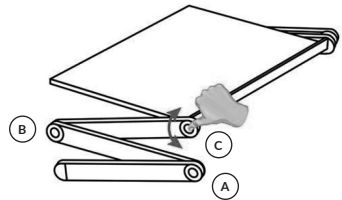

**Step 3:**  
Press and hold the button on Joint C to rotate the upper leg until it reaches the desired angle. The button will bounce back out if the upper leg has been locked in place.

## UPFOLDING THE LAPTOP STAND

**Step 1:**  
Press and hold the button on Joint C to rotate the upper leg so it sits even with the laptop tray.

**Step 2:**  
Press and hold the button on Joint B to rotate the middle leg so it sits even with the upper leg.

**Step 3:**  
Press and hold the button on Joint A to rotate the lower leg so it sits even with the middle leg.

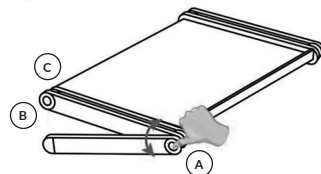
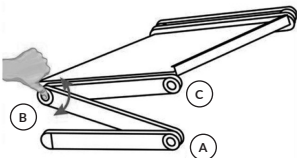
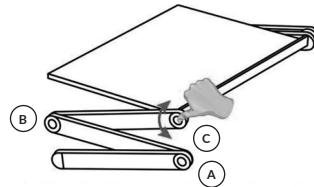

## NOTE

- DO NOT place a laptop on the unit until you make sure all the legs and the laptop tray are locked into place.
- Please make sure you have both sides locked at the same angle.
- If you need to readjust the angle of the laptop tray or legs, please refer to the steps in Unfolding the Laptop Stand
- Please hold the laptop tray using your fingers if you try adjusting legs on both sides at the same time.
- If you fail to rotate the leg, please make sure you push the button deep in.
- Adjustments should go from lower leg, to middle leg, to laptop tray when unfolding the unit; when folding the unit, they should be done in the reverse order (laptop tray → middle leg → lower leg)
- Max weight capacity is 33 lbs. (15kg). DO NOT overload!

## INSTALLING THE MOUSE TRAY

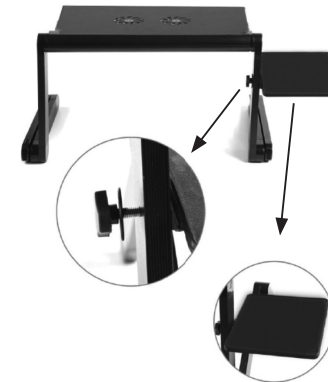

1. Slide the washer onto the star knob.
2. Place the laptop stand with its front lip facing you.
3. Put the mouse tray on the right side of the right upper leg and line up their holes.
4. Screw the knob through the holes.

1. Attach an edge stopper to the front lip of the laptop tray, fitting its groove over the lip. (The flat side of the stopper should sit on the tray.)
2. Rotate the stopper to 90 degrees.

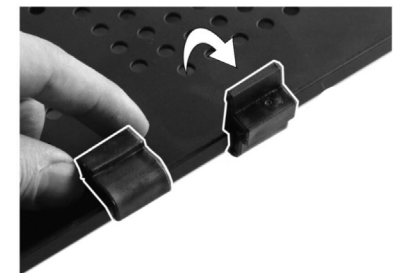

## HOW TO USE COOLING FANS



### USED ON YOUR BED

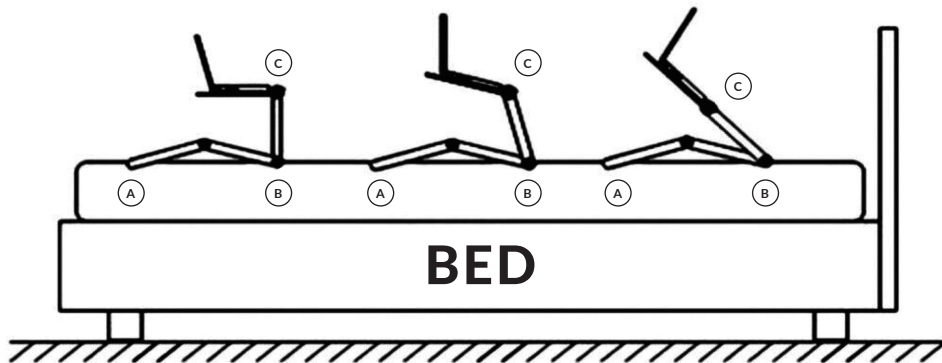

1. Press and hold the button on Joint A and rotate the lower leg until the arrow points to 150°.
2. Press and hold the button on Joint B and rotate the middle leg until the arrow points to 30° -90°.
3. Press and hold the button on Joint C and rotate the upper leg until the arrow points to 90°-180°.
4. Adjust the middle leg properly to create the most comfortable viewing angle.

### USED OUTDOORS

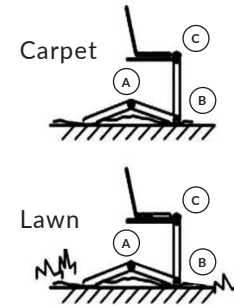

1. Press and hold the button on Joint A and rotate the lower leg until the arrow points to 120°.
2. Press and hold the button on Joint B and rotate the middle leg until the arrow points to 60°.
3. Press and hold the button on Joint C and rotate the upper leg until the arrow points to 90°.
4. Adjust the upper leg properly to create the most comfortable viewing angle.

### USED ON SOFA

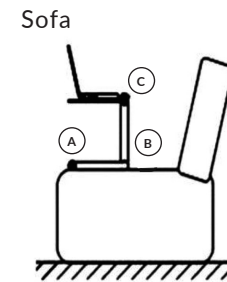

1. Press and hold the button on Joint A and rotate the lower leg until the arrow points to 0°.
2. Press and hold the button on Joint B and rotate the middle leg until the arrow points to 90°.
3. Press and hold the button on Joint C and rotate the upper leg until the arrow points to 90°.
4. Adjust the upper leg properly to create the most comfortable viewing angle.

### USED ON TABLE

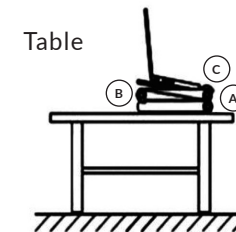

1. Press and hold the button on Joint A and rotate the lower leg until the arrow points to 90°.
2. Press and hold the button on Joint B and rotate the middle leg until the arrow points to 15°.
3. Press and hold the button on Joint A and rotate the lower leg until the arrow points to 30°.
4. Adjust the upper leg properly to create the most comfortable viewing angle.

## DIFFERENT CONFIGURATIONS & HEIGHTS

---

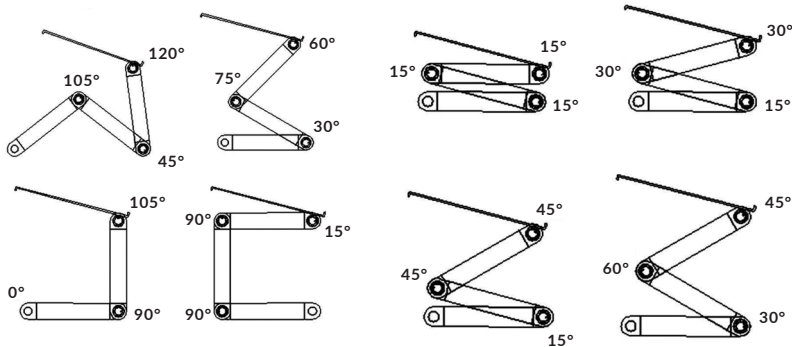

## LIMITED LIFETIME WARRANTY

---

Your Medic Therapeutics Adjustable Laptop Desk is backed by a limited lifetime manufacturer's warranty. Medic Therapeutics will repair or replace your device at any time should it fail due to a defect in material or workmanship, subject to the certain limitations.

This limited warranty does not cover any damage that results from unauthorized or improper use, service, or repair. Further, it does not cover damage caused by accident, impact, negligence, or normal wear and tear. Should you discover your Medic Therapeutics Adjustable Laptop Desk is not functioning properly, please send your device to our repair center for evaluation. If your product cannot be repaired or serviced, we will reserve the right to change it for a similar or newer model.

Please note that a flat rate of \$35.00 will be charged to cover a service evaluation fee and return shipping of your device. All warranty claims must be accompanied by a copy of your proof of purchase from an authorized retailer. Please send your device, proof of purchase, and a check or money order in the amount of \$35.00 made out to Medic Therapeutics to:

Address:  
Medic Therapeutics Service Center  
3069 Taft Street  
Hollywood, FL 33009

Contact:  
[warranty@medictherapeutics.com](mailto:warranty@medictherapeutics.com)