



**MEDIC
THERAPEUTICS**

SPECIAL EDITION

VIBRATING FITNESS PLATFORM WITH MAGNETIC THERAPY

User Manual



Please read this user manual carefully prior to operating the platform and pay special attention to the safety precautions to ensure proper product operation. Please keep this user manual for further reference.

SAFETY PRECAUTIONS

- Do not use the product in a humid or dusty environment to avoid electric shock or break down of mechanical parts.
- Do not use the product when the indoor temperature is over 104° F (40° C).
- Do not use the product in an outdoor environment with open air or under direct sunlight.
- Place the product on a flat surface.
- Do not use the product under the conditions stated below:
 - Patients under any type of treatment that do not feel well or are suffering from a malignant tumor; consult your doctor before use.
 - Pregnant women or women in their menstrual cycle.
 - People with heart disease.
 - Osteoporosis patients.
 - People with a heart pacemaker or other medical electronic instrument implant.
 - People with artificial limbs.
 - People who are sensitive to vibration and strenuous exercise.
- Please wait for one hour before using the product when it is moved from low to high temperature environments to prevent water vapor from condensing on the machine and resulting in product failure.

IMPORTANT NOTICES DURING OPERATION:

- Before using, put away any loose valuable objects on you, such as heavy jewelry, watch, bangle, and cell phone. Any keys, knife, or other sharp items should also be put away to avoid damage or bodily injury.
- Do not smoke while using the product.
- Please do not use the product together with other medical equipment.
- Please do not use the product for medical treatment purposes.
- Do not use the product right after a meal or drink.
- During use, please keep children or pets away from the product.
- Do not insert fingers or other foreign bodies into the gap between the middle cover and base cover.

- Supervision is required for any child under the age of 10 and any adult over the age of 60.
- This product is limited for one-person use.

NOTE:

- If power failure occurs:
 - It may be due to poor weather conditions outside (thunder and lightning).
 - Check plug and power cord:
- Check if the voltage complies with the one specified for the product. Do not retract the power plug with wet hands to prevent electric shock. Hold the plug rather than the power cord to pull out the power cord.
- Turn off the power switch and remove the plug from the power supply in case of electrical failure if not in use for a long time.
- Stop using the product if the power cord has any damage. Turn off the power switch, pull out the plug, and contact technicians for repair.

 **WARNING**

- Unauthorized dismantle, disassembly, or renovation is not allowed in order to prevent electrical shock or any malfunctions. Please contact the manufacture or local dealer immediately if there is any service work needed.
- Stop using the product, power off, and remove the plug from the power supply if any of the following conditions below happens:
 - Water or other liquid is accidentally splashed onto the product or controller.
 - Any accessory is found damaged, or an internal component is exposed.
 - The user feels abnormal or gets severe pain during use.

PRODUCT SPECIFICATIONS

Product Name:	Medic Therapeutics Special Edition Vibrating Fitness Platform
Input:	100V, 50/60Hz, 200W
Dimension:	660x440x130mm
Net weight:	11KG
Gross weight:	18KG

PRODUCT OVERVIEW

1. Suction cup legs
2. Power switch
3. AC adapter socket
4. Exercise band hook
5. Wheels for Portability

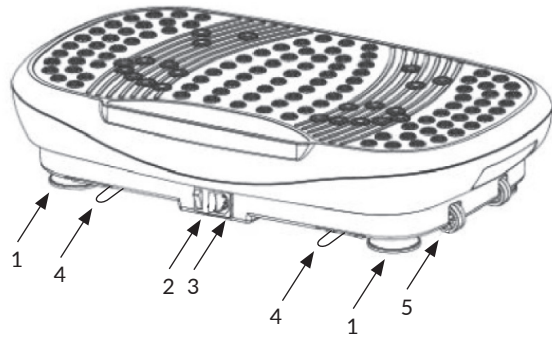

CONTROL PANEL OPERATION

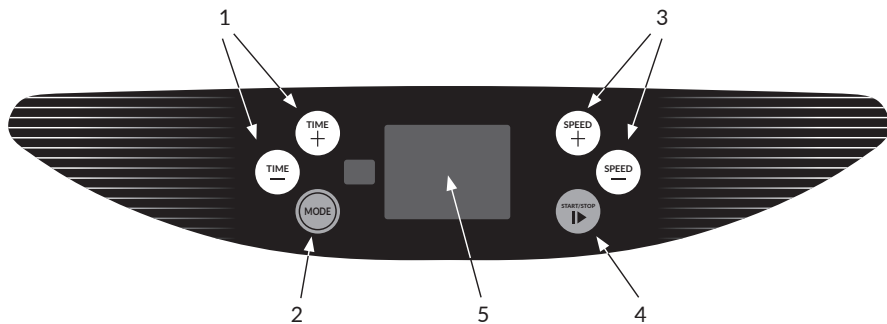

1. **Time +/-:** running time adjustment.
2. **Mode:** automatic mode or manual mode operation
3. **Speed +/-:** vibration speed adjustment.
4. **Start/Stop:** start and stop the machine.
5. **LED Display Window:** displays the current mode during runtime, speed and calories burnt during use.

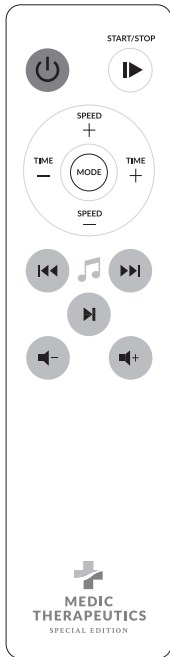

Power: press to turn on/off



Start/Stop: press to start/stop the automatic setting



Mode key: press to select the desired mode. Select between three options of Automatic workouts or Manual mode.



Top-Down +/- key: press to adjust the speed of the platform while using it in manual mode.



Left-Right +/- key: press to adjust the time duration before starting a new manual mode session.



Previous: press to play back previous track when streaming music



Next: press to play next track when streaming music



Play/Pause: press to play or pause music



Volume +: press to raise the volume when streaming music



Volume -: press to lower the volume when streaming music

BLUETOOTH FEATURE FOR STREAMING MUSIC

The platform enables you to connect your devices to Bluetooth and stream music.

How to connect to the platform's Bluetooth:

1. Open up Bluetooth pairing settings on your device.
2. Find a network named "MT Vibrate Sound"; select and pair to your device.
3. Music can be controlled from your device and will play through the platform's speakers.
4. Alternatively, you can adjust the volume, track, play/pause of your music by using the remote control.

TRANSPORTING THE PLATFORM

Two handles can be found on both ends of the middle cover. When moving the product, lift the end opposite of the wheels, grasp the handle and move the product to the desired place.

Handle

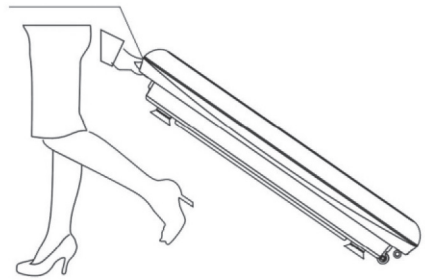

ABOUT MAGNETIC THERAPY:

The use of magnets as a healing property dates as far back as 2000 B.C., commonly used within the Chinese, Aztecs, and Mayan cultures. Magnetic therapy focuses on maintaining the body's proper electromagnetic field to promote wellness. Some of the healing factors related to magnetic therapy are assisting with pain relief, reducing minor swelling, and all-around wellness by temporarily increasing micro-circulation.

The benefits are endless with this Medic Therapeutics Vibrating Fitness Platform and the magnetic therapy built into it. With high-frequency vibration and sway- combined with various exercise postures -this machine can deeply stimulate muscle tissue, lower fat accumulation, rehabilitate muscle elasticity, sculpt beautiful body shape and make users feel vitalized/confident. See whole body exercise positions and massaging tips for best results.

WHOLE BODY EXERCISE POSITIONS & MASSAGING TIPS:

Total Upper Body

Place both hands on platform shoulder width apart and push yourself up. Stretch legs out back. Hold position.

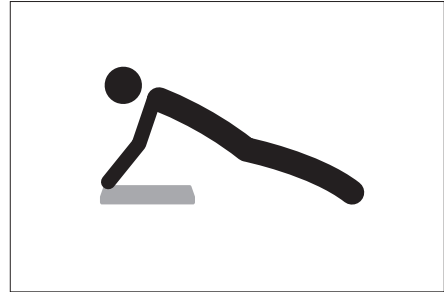

Pelvic Bridge

Lay down flat on the floor and place both feet on platform, shoulder width apart. Slowly raise pelvic region up and hold position.

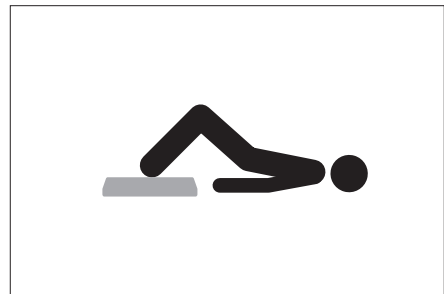

Lower Back

Stand in front of the platform and turn your back to it. Kneel down and place one knee on the platform the other leg will remain off the platform. Hold position.



Latissimus Dip

Sit on the floor in front of platform giving it your back. Place both hands shoulder width apart on the platform. Stretch arms completely and lift yourself up from the floor and keep both knees bent in front of you. Hold position.



Tricep Dip

Sit on the floor in front of platform giving it your back. Place both hands shoulder width apart on the platform. slightly bend elbows and lift yourself up from the floor. Keep both knees bent in front of you. Proceed with work out carefully.



Shoulder Press

Stand in front of the platform facing it. Slowly bend over and place both hands flat on the platform. Keep legs stretched out. Hold position.

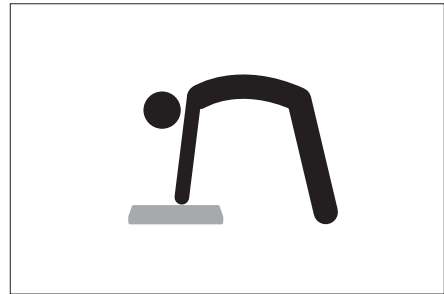

Adductor Stretch

Stand in front of the platform and give it your side. Stretch one leg out to towards the platform and place foot on it. Leave other foot on the floor and slightly bend your knee. Place both hands on your hips for balance. Hold position.



Ab Crunch

Slowly lay down flat on the platform. Place both hands behind your head and lift up. Raise both legs up and bend your knees. Hold this position.

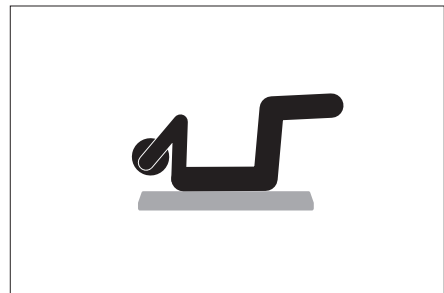

Lower Extremities

Place chair in front of the platform and sit down on the chair. Place both feet on the platform.



Sit Up Twist

Slowly sit on platform. Stretch one arm and place hand on the floor. Take the other arm, bend it, and place hand behind your head. Stretch one leg out and place foot on the floor. Bend the other leg and place it on the platform. Proceed with work out carefully.



Lower Abs

Place both elbows shoulder width apart on the platform and hold yourself up. Stretch legs out back. Hold position.

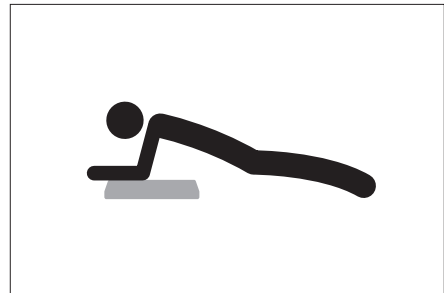

Side Crunch

Lay down on your side on the platform. Stretch one arm out and place hand on the floor. Place other arm on your side. Stretch both legs out and hold them above the floor. Proceed with work out carefully.

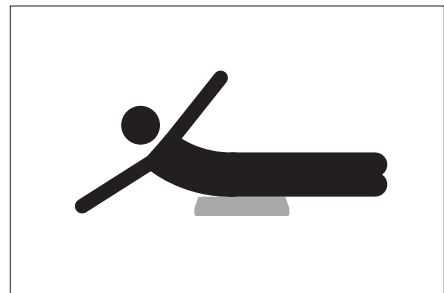

Lateral Abs

Lay down on the floor on your side. Place one elbow on the platform and hold yourself up. Place other arm on your side. Stretch legs out and place feet on the floor to help your balance. Proceed with work out carefully.



Shoulder & Neck

Kneel in front of the platform, lean forward and stretch both arms out placing both hands on the platform. Make sure your back is flat. Hold position.

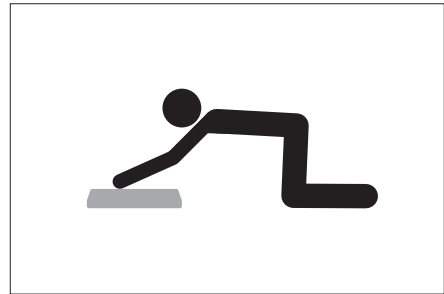

Chest (Pectoralis)

Stand on the platform. Slightly bend your knees. Hold resistance bands on your hands and gently pull them up towards your chest. Proceed with work out carefully.



Triceps

Stand on the platform. Slightly bend your knees. Hold resistance bands on your hands with arms stretched out in front of you. Gently pull on the resistance bands. Proceed with work out carefully.



Deltoids

Stand on the platform. Slightly bend your knees. Hold resistance bands on your hands with arms stretched out in front of you. Gently pull on the resistance bands. Proceed with work out carefully.



Pecs/Ext. Obliques

Stand on the platform. Slightly bend your knees. Hold resistance bands on your hands with arms down in front of you. Gently pull on the resistance bands. Proceed with work out carefully.



Biceps

Stand on the platform. Slightly bend your knees and your elbows. Hold resistance bands on your hands in front of you and gently pull them up towards your chest. Proceed with work out carefully.



Abductor Massage

Slowly lay on your side on the platform. Place one elbow on the floor and stretch other arm on your side. Bend both your knees and rest them on the platform. Hold position.

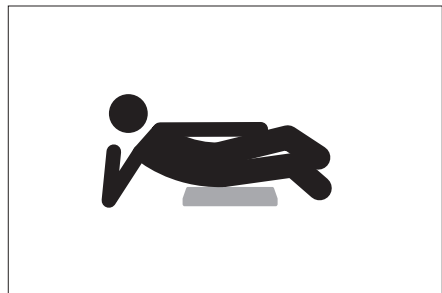

Hamstring Massage

Slowly sit on platform. Stretch your legs forward with slightly bent knees and your feet are flat on the floor. Stretch your upper body back and arms out placing both hands on the floor. Hold position.

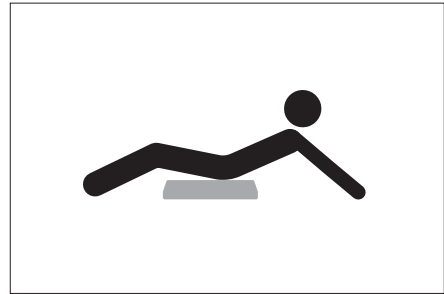

Calves Massage

Lay flat on the floor. Place legs on platform making sure that your calves are directly touching the platform. Hold position.

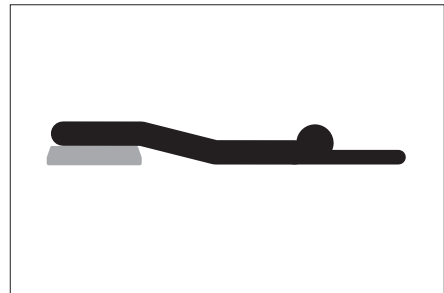

Quadriceps Massage

Lay face down on the floor. Place legs on platform making sure your thighs are directly on touching the platform and bend your knees. Bend your arms as well and lay on your forearms to help you hold your position. Back must be flat. Hold position.

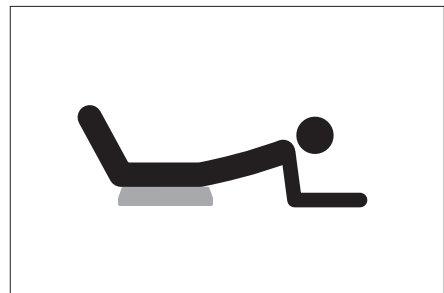

Upper Body Relaxer

Sit in front of the platform and give it your back. Place both elbows shoulder width apart on the platform. Legs will be facing forward with knees bent. Hold position.



Back Relaxer

Slowly sit on platform and keep both your knees up and feet flat on the floor. Hunch over placing hands flat on the floor. Hold position.



STORAGE AND MAINTENANCE

- Make sure that the power switch is turned off and the plug is removed from the power supply.
- Clean off the dust and dirt on the product and keep it clean and away from places with high temperatures and high humidity.
- If the product is not in use for an extended period of time, a dustproof cover (must be purchased separately) should be placed on the product to prevent dust entry.

Surface Cleaning

- Before cleaning, ensure the power switch is turned off, and the power plug is pulled out of the socket.
- The rubber pedal and covers can be cleaned with a wet cloth containing soft detergent, and the soft detergent should then be removed with a clean cloth.

⚠ Notice

Do not clean the product with corrosive detergent such as benzene or thinner, as it may cause fading, corrosion, or cracks on the product. Do not splash water onto the product to avoid short circuits.

Controller Cleaning

Only use a dry cloth; a wet cloth may cause malfunction of the controller.

TROUBLESHOOTING

S/N	Problems	Causes	Solutions
1	The platform is not turning on	The plug is not in place	Insert the plug correctly to device and plug proper end to AC adapter on the wall
		The power switch is off	Turn switch on
2	The platform makes inconsistent sounds	Due to the motor and vibration of the platform, it is normal for the machine to make such sounds	No additional treatment is required
3	The platform is not responding to remote control	Batteries are low on energy	Replace batteries
		Remote control is out of range	Remote control must be at infrared signal range of 8.2 feet (2.5M)
4	Platform stops suddenly	Default working time is finished	Restart the platform after 10-minute intervals
5	The platform is not properly responding	Too many commands are being requested at the same time	Turn power switch off to restart the platform

LIMITED LIFETIME WARRANTY

Your Medic Therapeutics Special Edition Vibrating Fitness Platform with Magnetic Therapy is backed by a limited lifetime manufacturer's warranty. Medic Therapeutics will repair or replace your device at any time should it fail due to a defect in material or workmanship, subject to the certain limitations.

This limited warranty does not cover any damage that results from unauthorized or improper use, service, or repair. Further, it does not cover damage caused by accident, impact, negligence, or normal wear and tear. Should you discover your Medic Therapeutics Special Edition Vibrating Fitness Platform with Magnetic Therapy is not functioning properly, please send your device to our repair center for evaluation. If your product cannot be repaired or serviced, we will reserve the right to change it for a similar or newer model.

Please note that a flat rate of \$35.00 will be charged to cover a service evaluation fee and return shipping of your device. All warranty claims must be accompanied by a copy of your proof of purchase from an authorized retailer. Please send your device, proof of purchase, and a check or money order in the amount of \$35.00 made out to Medic Therapeutics to:

Address:

Medic Therapeutics Service Center
3069 Taft Street
Hollywood, FL 33009

Contact:

warranty@medictherapeutics.com



**MEDIC
THERAPEUTICS**
SPECIAL EDITION