

Step 11



Step 12



Step 13

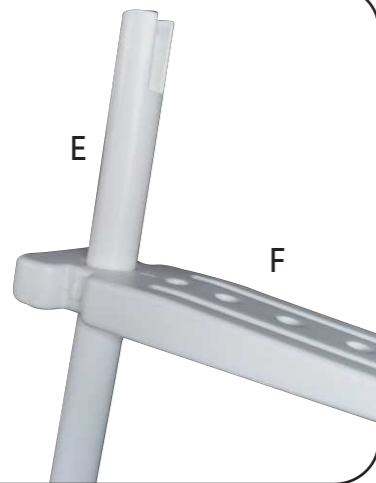

Step 14

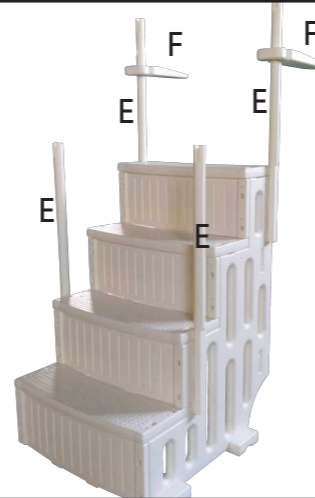

Step 15

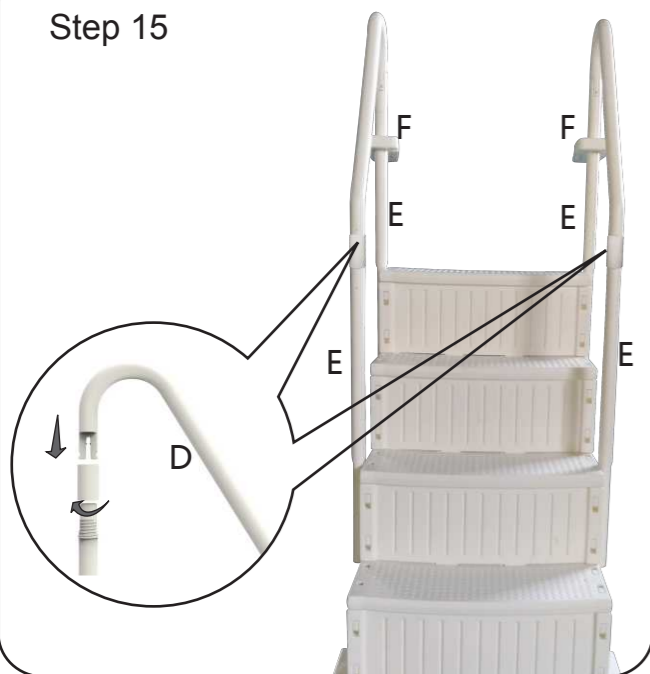

Step 16



ASSEMBLY AND INSTALLATION MANUAL

WEIGHT LIMIT 180 KGS

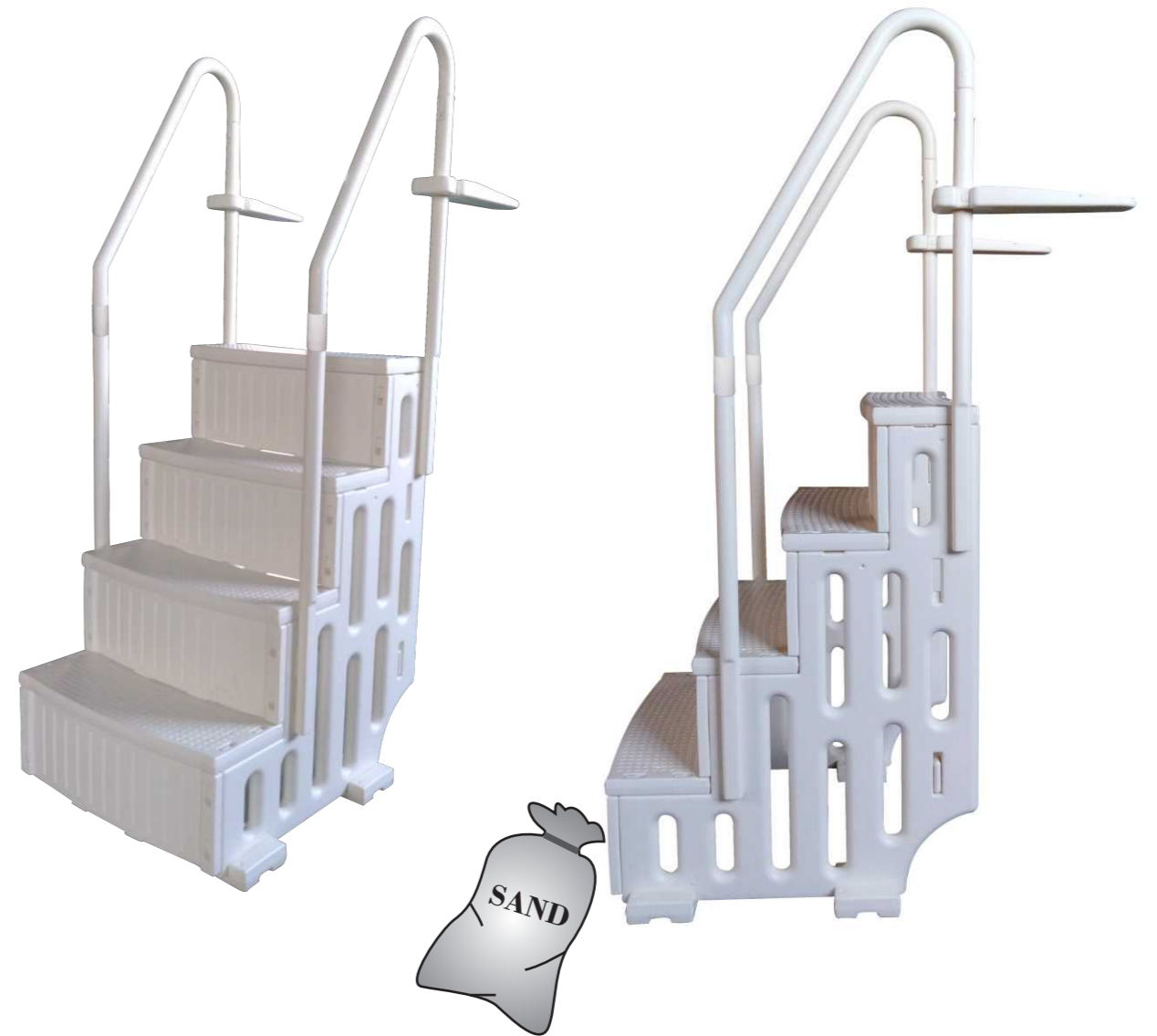

ASSEMBLY INSTRUCTIONS - PLEASE READ BEFORE ATTEMPTING ASSEMBLY

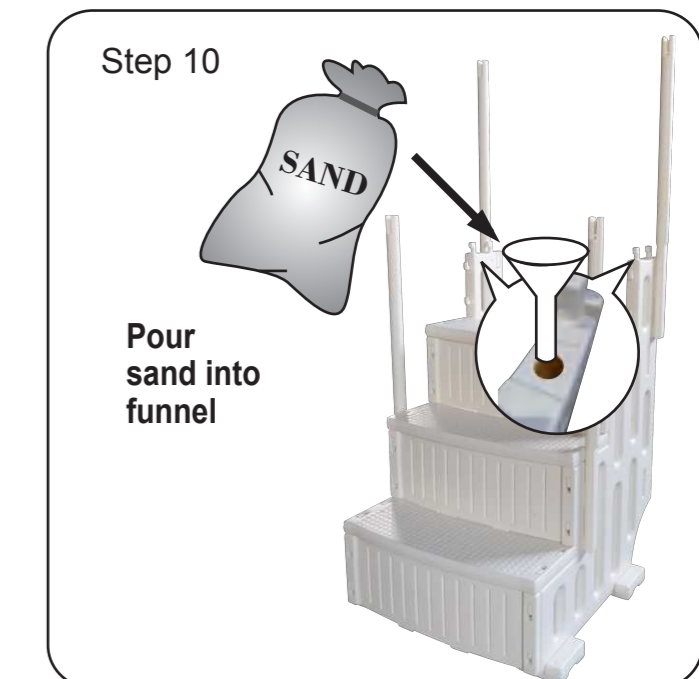
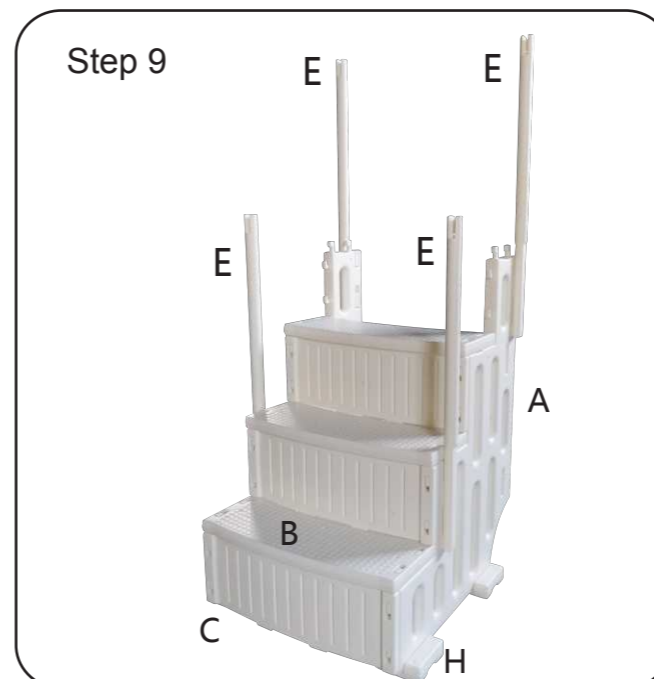
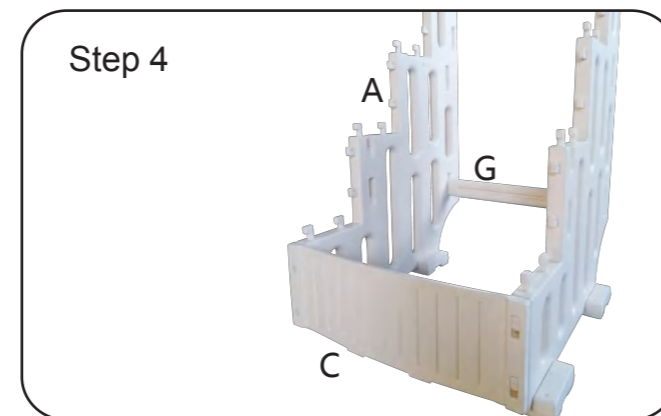
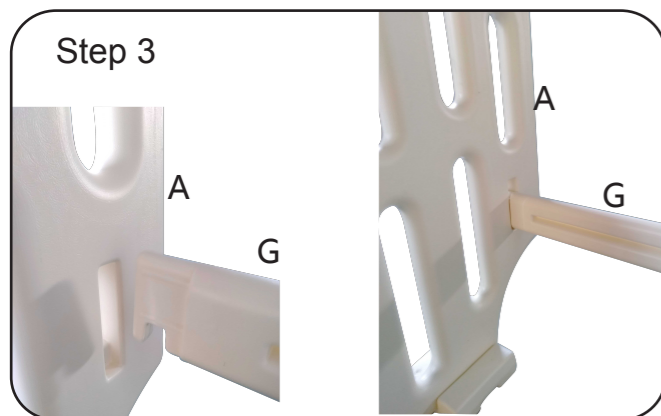
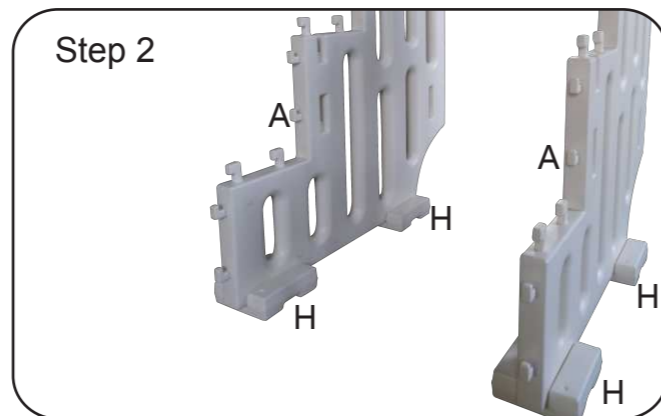
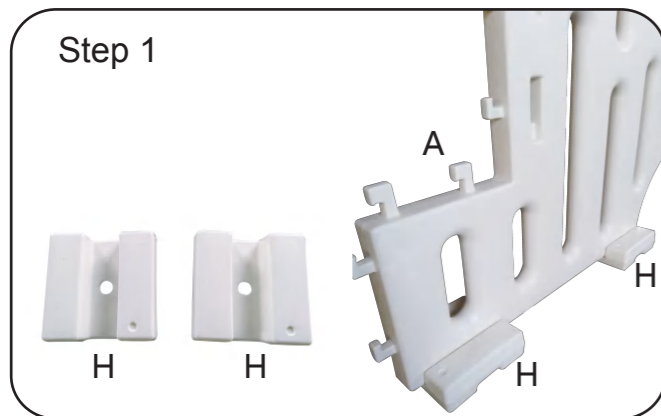
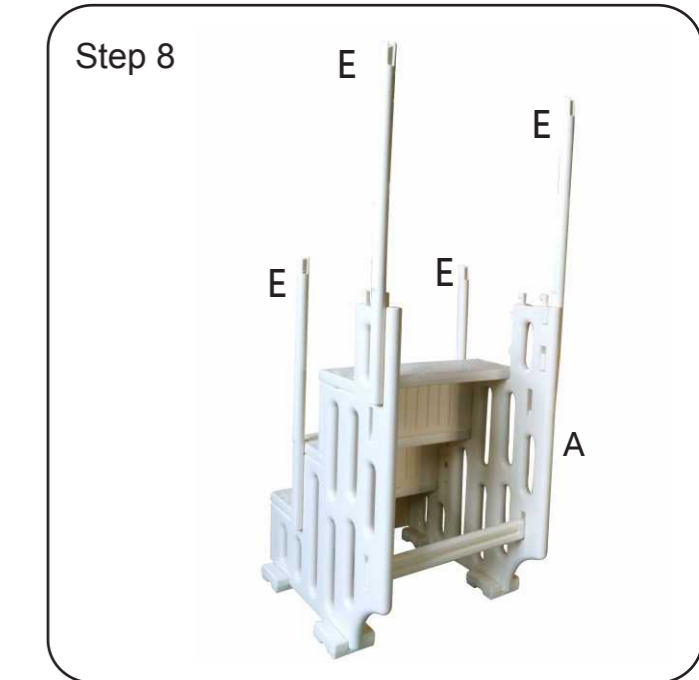
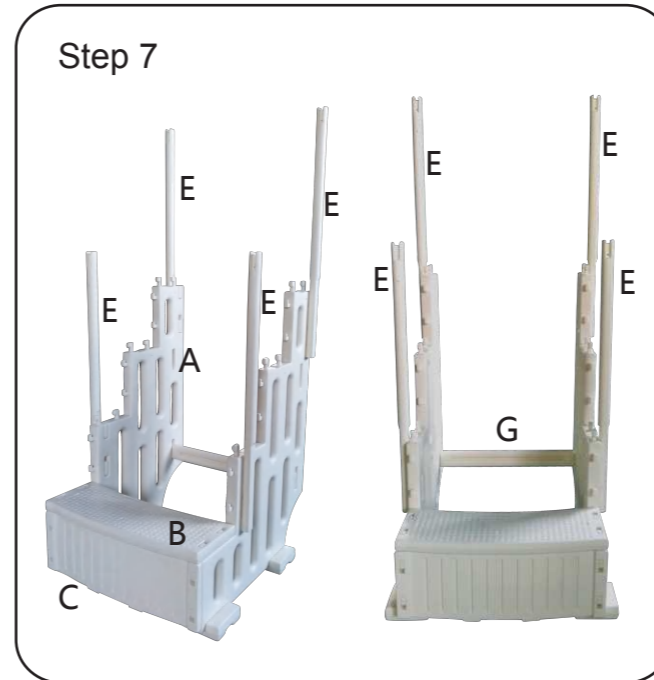
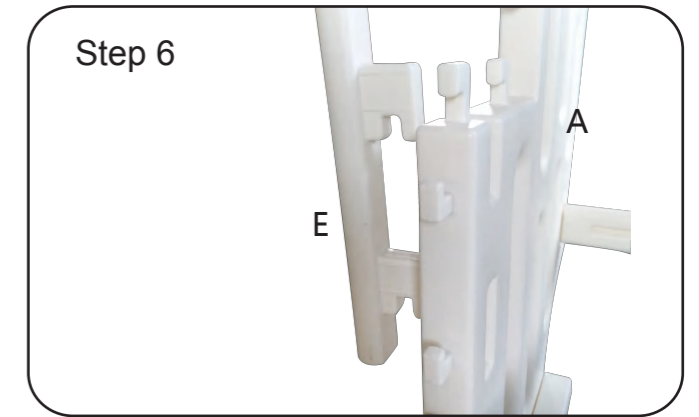
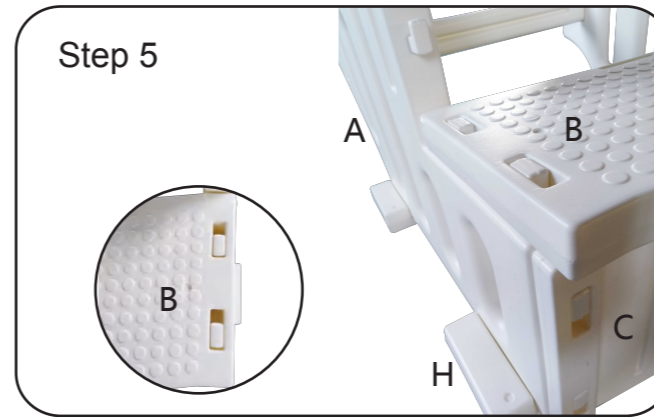
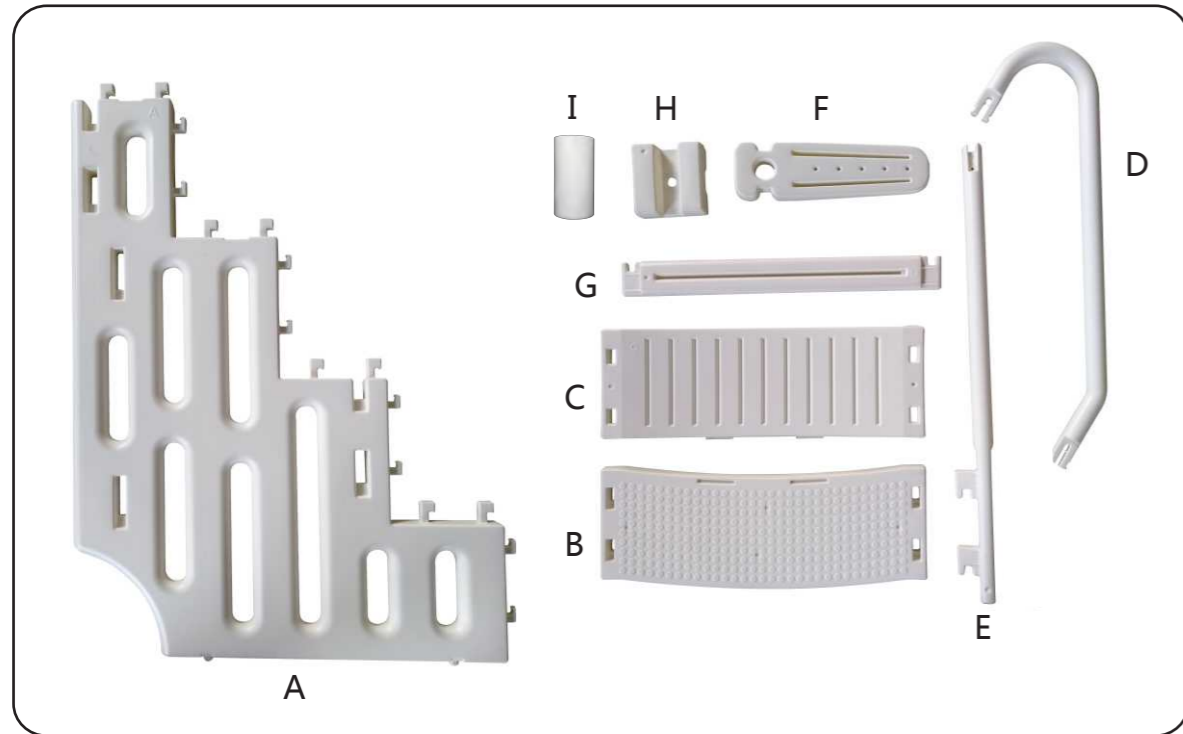

Please note: you need to prepare your own funnel and sand, and then pour the sand into the hole through the funnel to prevent the pool ladder from floating.