

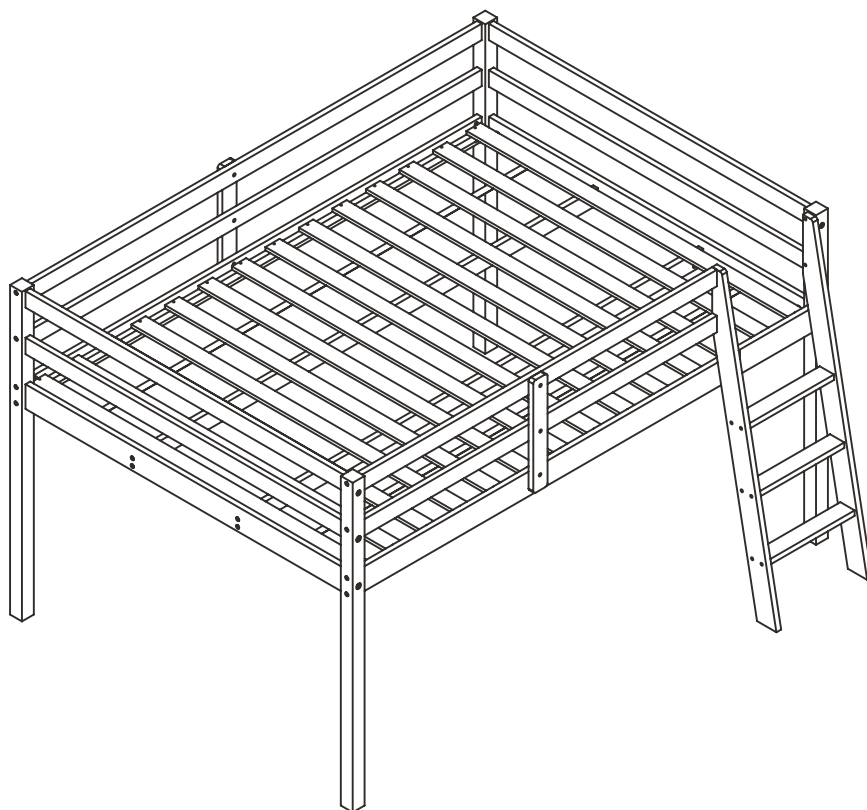

## VINGLI WOOD LOFT BED FULL SIZE

ASSEMBLY INSTRUCTION FOR MODELS

LB0PWFV



Thank you for purchasing from VINGLI!

Please contact us via email if parts are missing or damaged, we will gladly ship your replacement parts free of charge. Please attach your Order ID so that we can assist you better.

✉ EMAIL

🌐 WEBSITE

⚠ IMPORTANT

[support@vingli.com](mailto:support@vingli.com)

[www.vingli.com](http://www.vingli.com)

THIS INSTRUCTION BOOKLET CONTAINS IMPORTANT SAFETY INFORMATION. PLEASE READ AND KEEP FOR FUTURE REFERENCE.

# RETURN & WARRANTY

## Thank you for choosing our product!

We would like to take this opportunity to thank you for choosing VINGLI.

We hope that you are completely satisfied with your purchase, and enjoy it for years to come.



support@vingli.com

## Your satisfaction is our highest pursuit.

### Return Policy

VINGLI believes you will absolutely love your wood bed, but if for some reason you want to return the product, please contact us directly before you decide to return your product to the retailer. Our Customer Service organization can answer most concerns and can assist you with any questions you may have about your new product. Please contact us first by emailing support@vingli.com or by submitting a request at <https://www.vingli.com>

The item must be returned in good condition, in original box, with all original proof of purchase, parts and accessories, within the time frame specified by the retailer it was purchased from.

### Warranty

VINGLI warrants this product to be free from defects in material and workmanship agrees to remedy any such defect. This warranty covers one year from the date of original purchase. This is solely limited to be repair or replacement of defective parts and no assembly labor is included.

This warranty does not apply to any product which has been improperly assembled, subjected to misuse or abuse or which has been altered or repaired in anyway.

Components repaired or replaced warranted through the remainder of the original warranty period only. The defective components will be repaired or replaced without charge, subject to the terms and conditions described above.

For help with assembly, identifying parts, product information or to order parts, please contact us via support@vingli.com.

# BEFORE STARTING

## Before Using Product



- Read each step carefully before starting. It is very important that each step is performed in the correct order. If these steps are not followed in sequence, assembly difficulties will occur.



- Make sure all parts are included. Most board parts are labeled or stamped on the raw edge.

- Have the following tools.



- Recommended # of people needed for assembly: 2 (however it is always better to have an extra hand). Estimated assembly time is 2.5 hours.



- Work in a spacious area and near where the unit will be used, preferably on a carpet, or use a piece of the cardboard packaging to protect your floor and product.



- For a smooth assembly process, we suggest you keep a lite tightness for all the screws during assembly. After the whole product is assembled, firmly tighten all the screws.

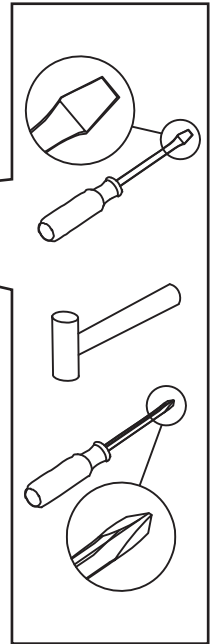

## WARNING

1. Follow the information on the warnings appearing on the upper bunk end structure and on the carton. Do not remove warning label from bed.
2. Always use the recommended size mattress or mattress support, or both, to help prevent the likelihood of entrapment or falls.
3. Surface of mattress must be at least 5 in. (127 mm) below the upper edge of guardrails.
4. Do not allow children under 6 years of age to use the upper bunk.
5. Periodically check and ensure that the guardrail, ladder, and other components are in their proper position, free from damage, and that all connectors are tight.
6. Do not allow horseplay on or under the bed and prohibit jumping on the bed.
7. Always use the ladder for entering and leaving the upper bunk.
8. Do not use substitute parts. Contact the manufacturer or dealer for replacement parts.
9. Use of a night light may provide added safety precaution for a child using the upper bunk.
10. Always use guardrails on both long sides of the upper bunk. If the bunk bed will be placed next to the wall, the guardrail that runs the full length of the bed should be placed against the wall to prevent entrapment between the bed and wall.
11. The use of water or sleep flotation mattresses is prohibited.
12. Keep these instructions for future reference.

# MODEL & ASSEMBLY TIPS

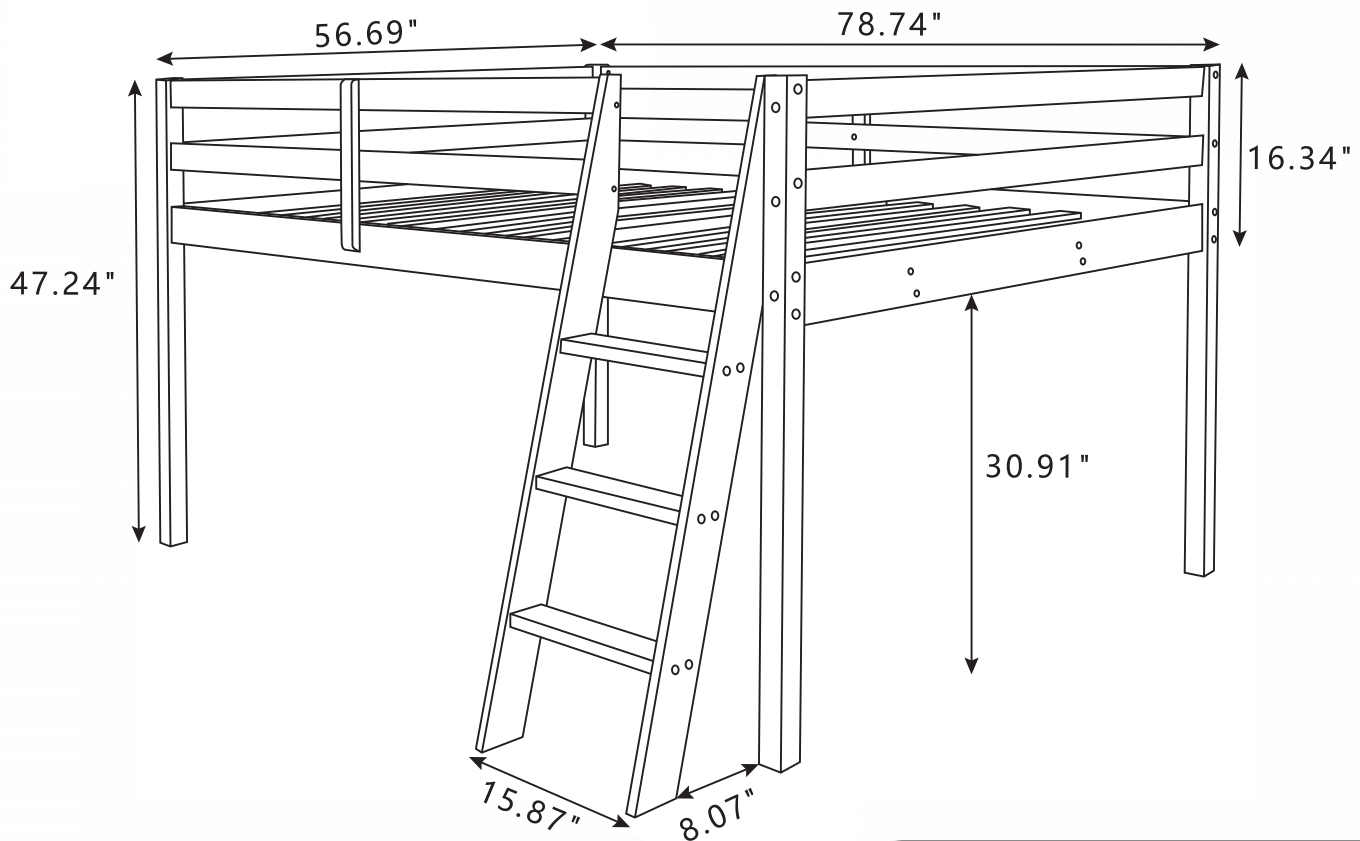

## Applicable Model

**MODEL:** LB0PFWW

**DIMENSION** Outside Dimensions:  
79"L x 57"W x 47.24"H  
Inner Frame Size: 54"W x 75"L

**FEATURES** 100% Solid Pine Wood with White Paint  
Load-Capacity: 551lbs



Estimated Time for Assembly

**70 mins**

## Caution

1. This product is designed for home use and not intended for commercial use.
2. This product contains small components. Please ensure that they are kept away from small children.
3. Be careful when using power tools to assemble your furniture. Power tools may strip or damage the parts

# IDENTIFY PARTS

All in **2** big boxes!

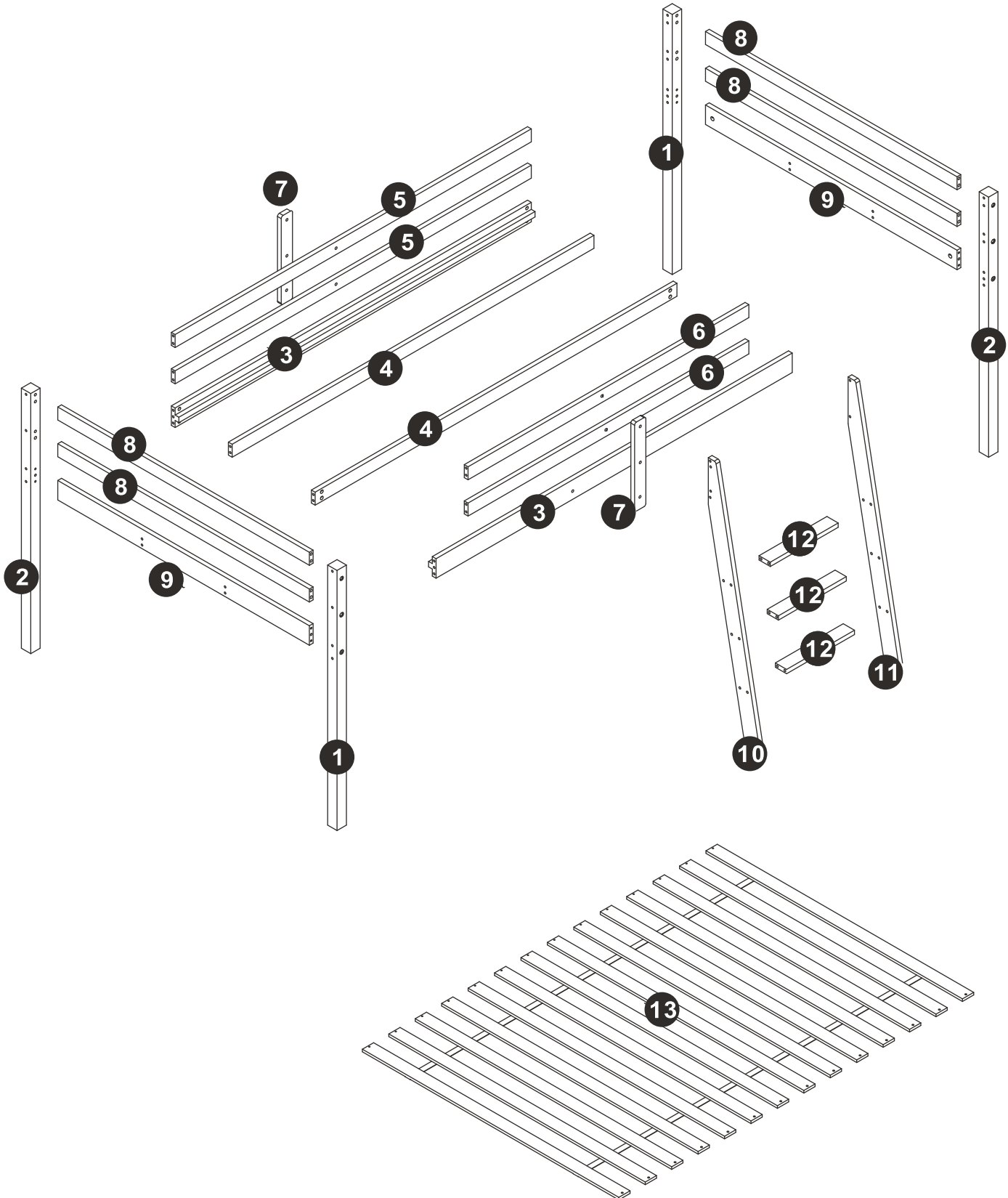

# PART LIST

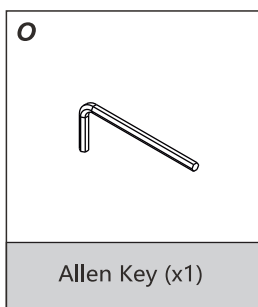
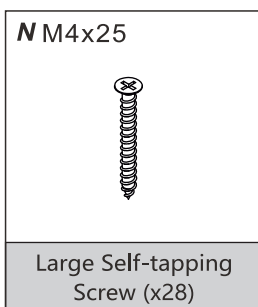
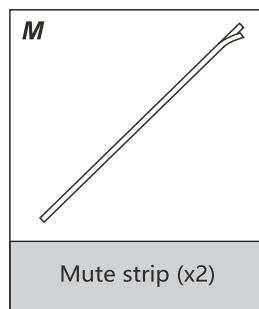
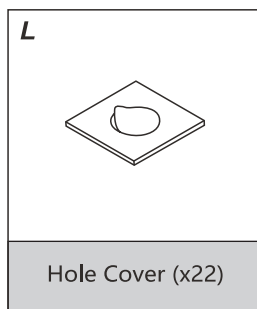
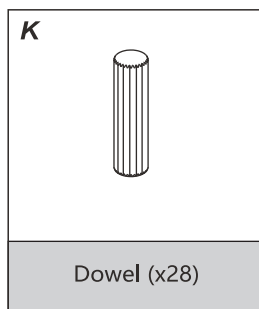
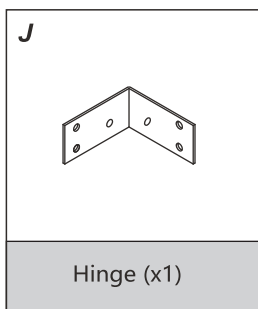
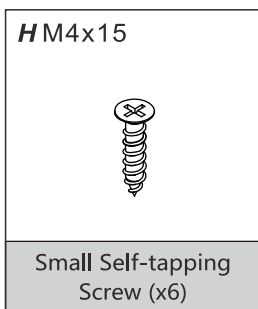
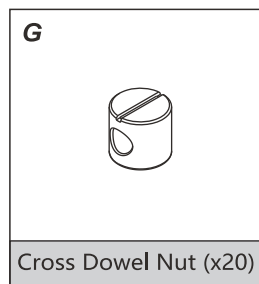
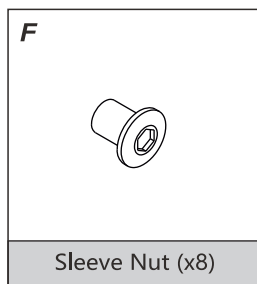
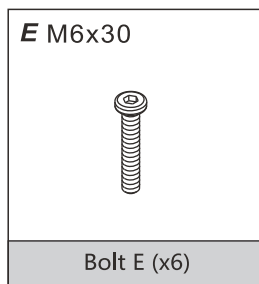
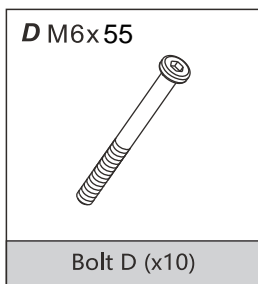
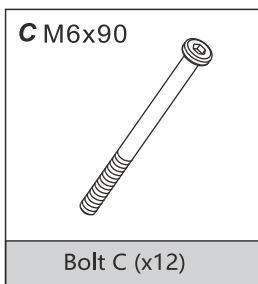
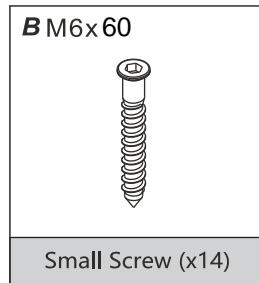
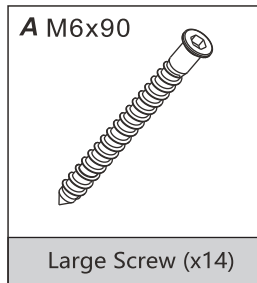
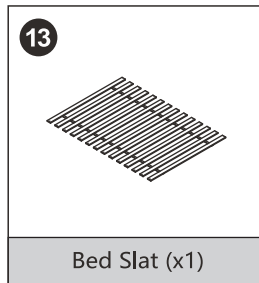
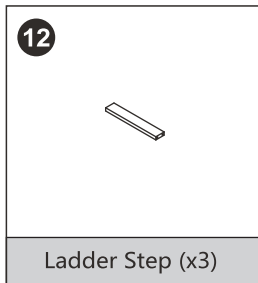
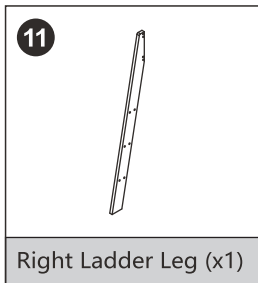
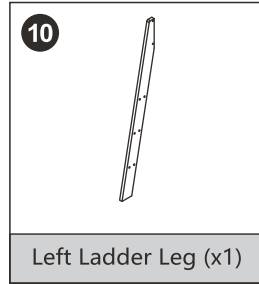
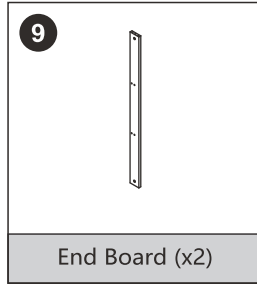
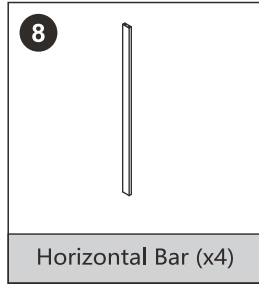
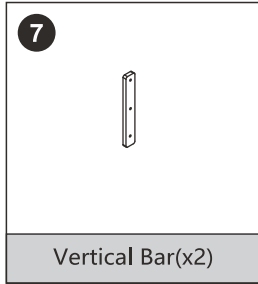
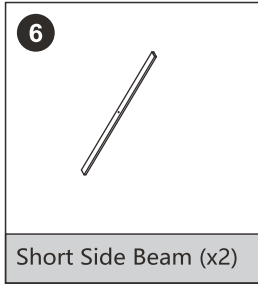
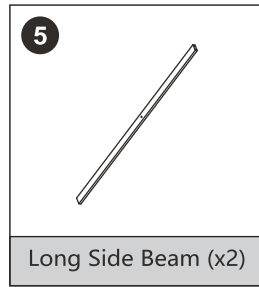
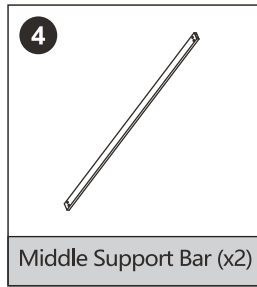
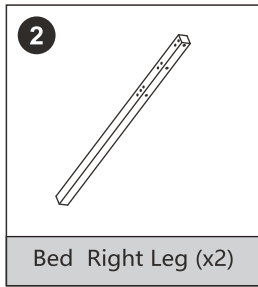
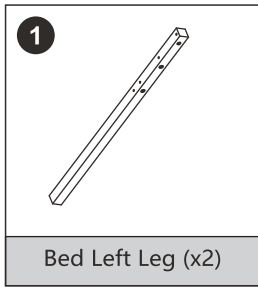

**TOOLS NEEDED FOR ASSEMBLY: FLAT & PHILIPS SCREWDRIVER (NOT INCLUDED)  
THE USE OF POWER SCREWDRIVER IS NOT RECOMMENDED**

# ASSEMBLY STEPS

New panels & accessories needed in below step

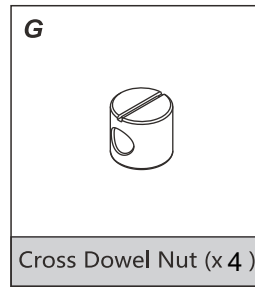
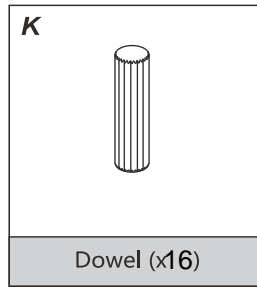
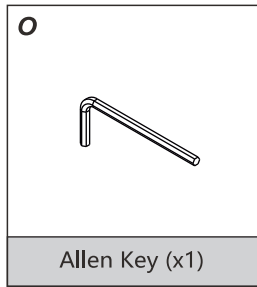
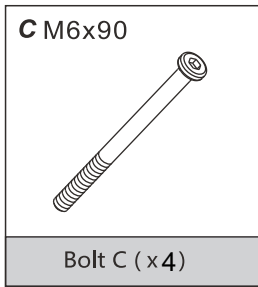
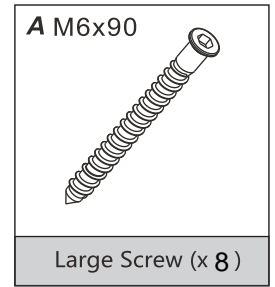
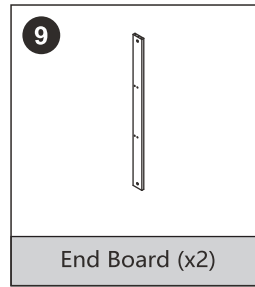
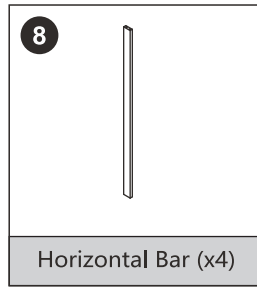
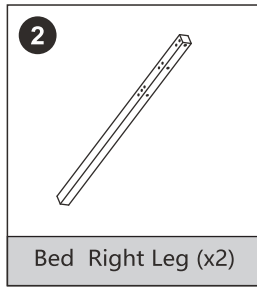
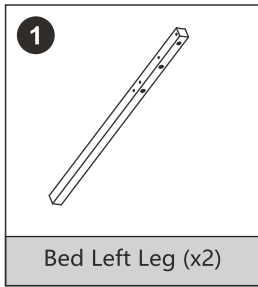

## STEP1-1

Assemble footboard:

- a: Insert dowels K into two #8 horizontal bars and #9 end board as figure shows, then insert them into corresponding holes of bed left and right legs respectively.
- b: Put cross dowel nuts G into #9 end board (\*Note: head of G should be placed parallel to bolt C), and finally fasten #8 bars and #9 end board to bed legs with screw A & bolt C.

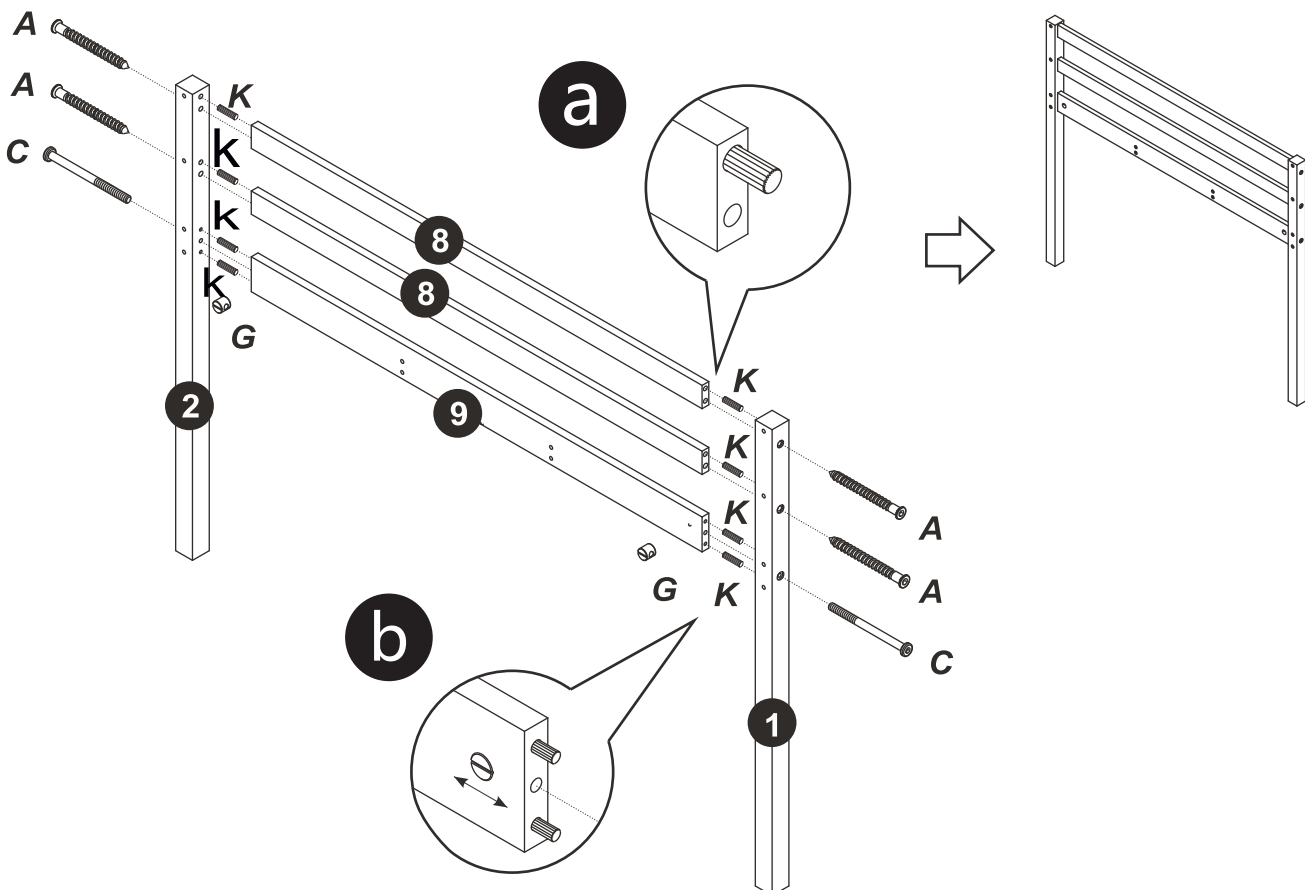

# ASSEMBLY STEPS

## STEP 1-2

Assembly steps of headboard are the same as footboard. Please notice fitting's hole position and do not tighten screws before bed assembly is done.

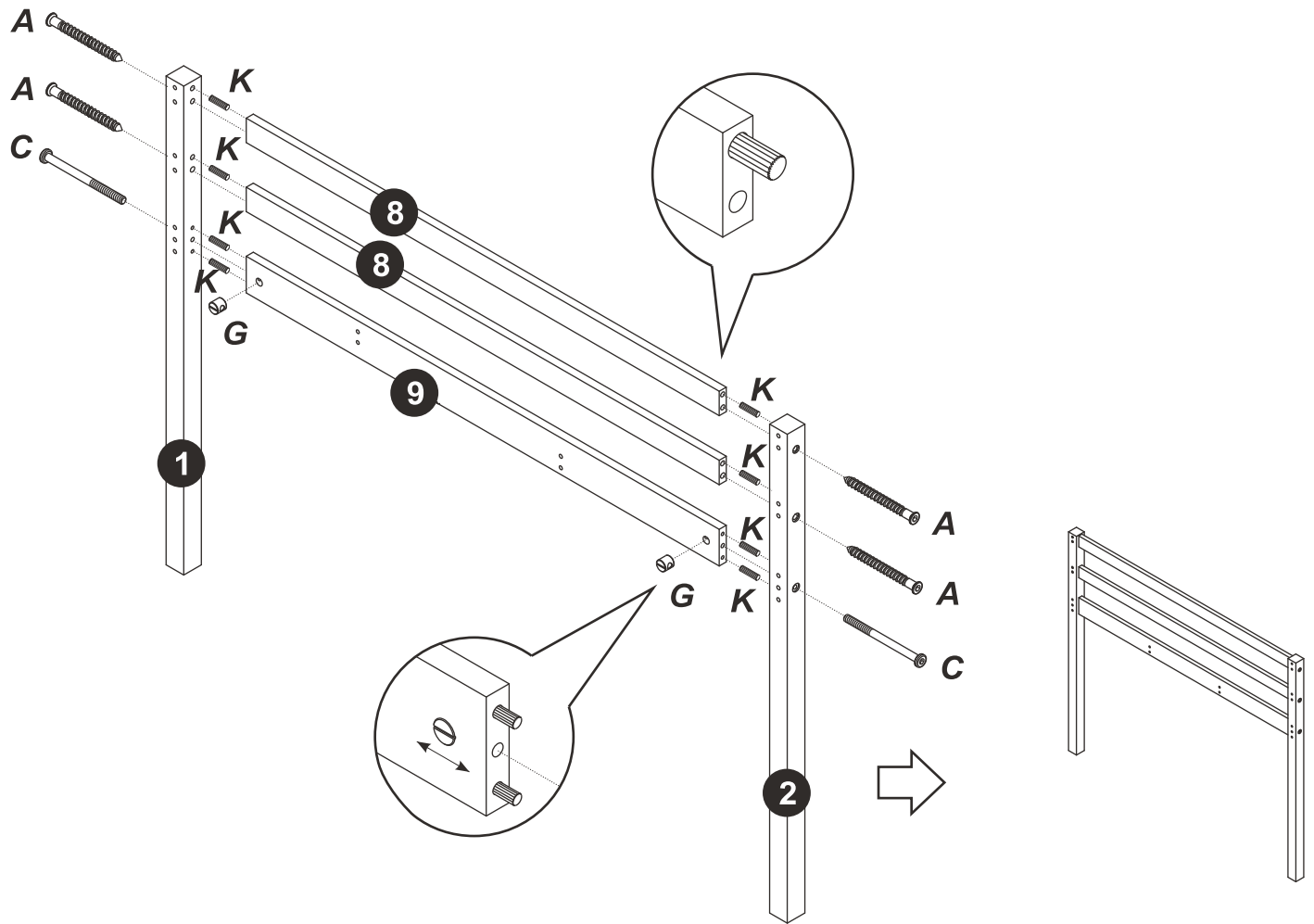



# ASSEMBLY STEPS

New panels & accessories needed in below step

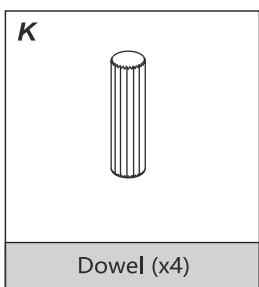
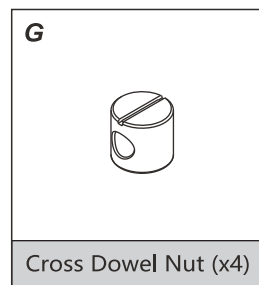
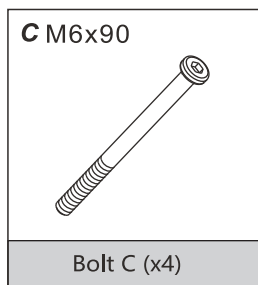
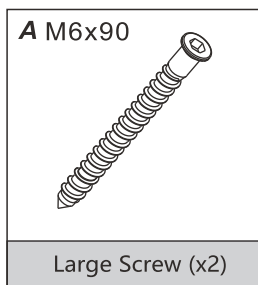
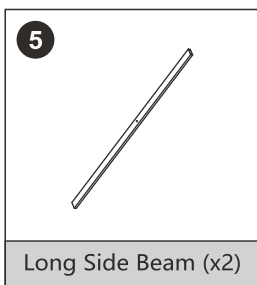
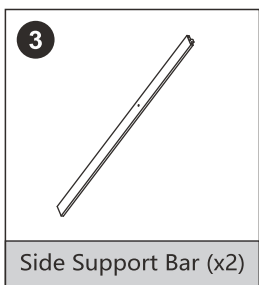

## STEP2

- a: Insert dowels K into #5 long side beam and #3 side support bar, then insert them into corresponding holes in the bed leg respectively.
- b: Put cross dowel nuts G into the holes of side bar, then fasten side bars to bed leg by tightening screw A & bolt C.

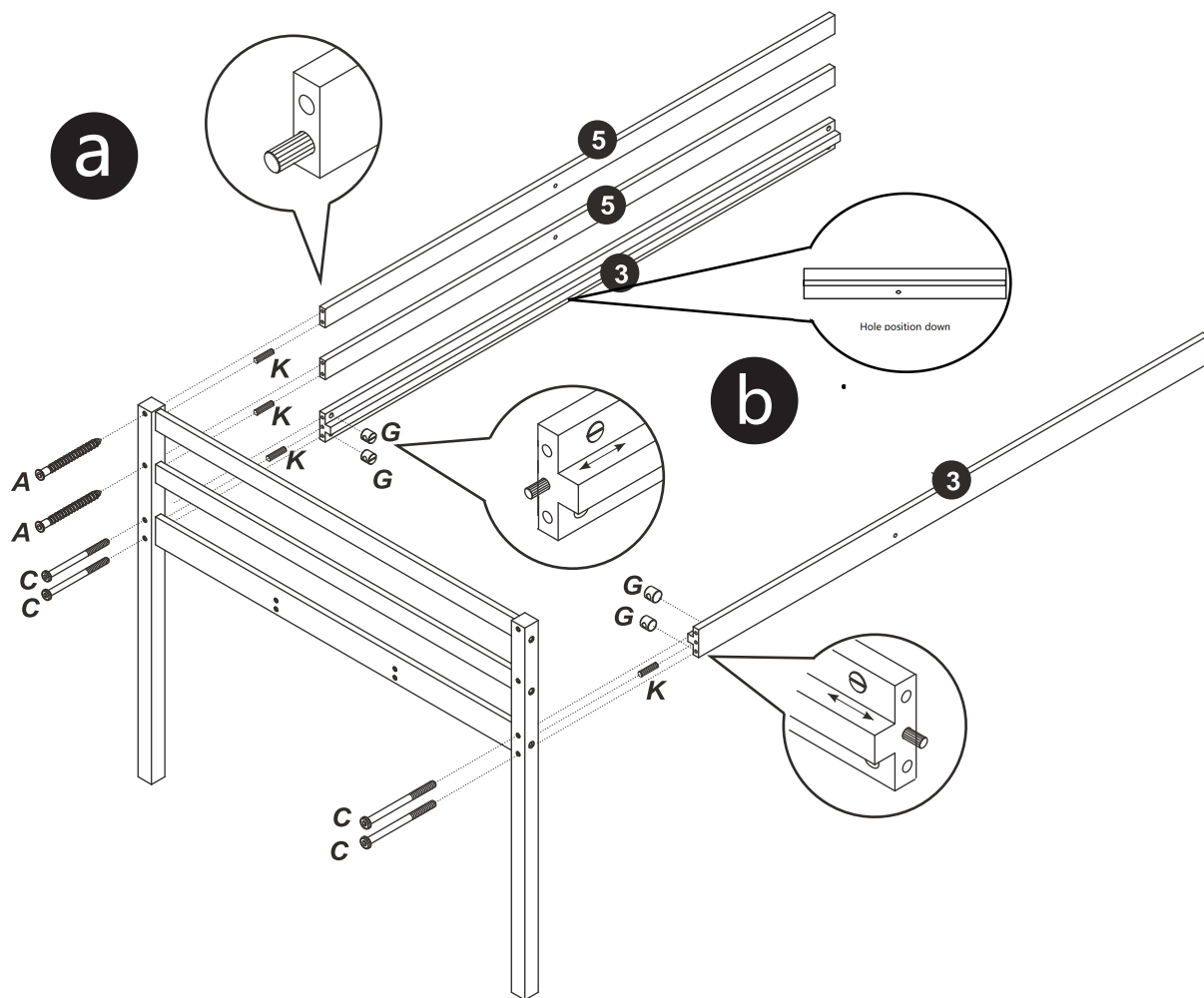

# ASSEMBLY STEPS

New panels & accessories needed in below step

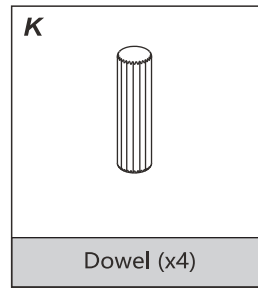
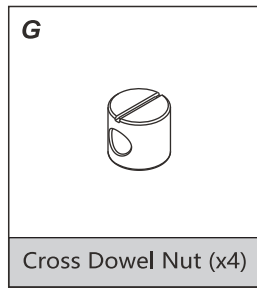
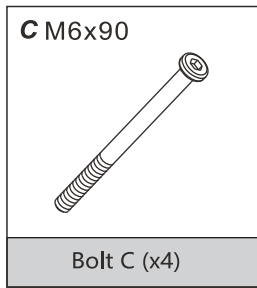
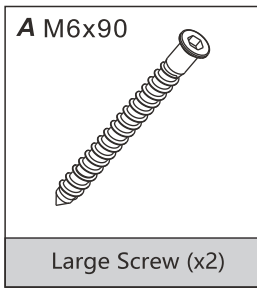

## STEP3

Repeat the above steps to connect the other end of side bars to bed leg on the other side.

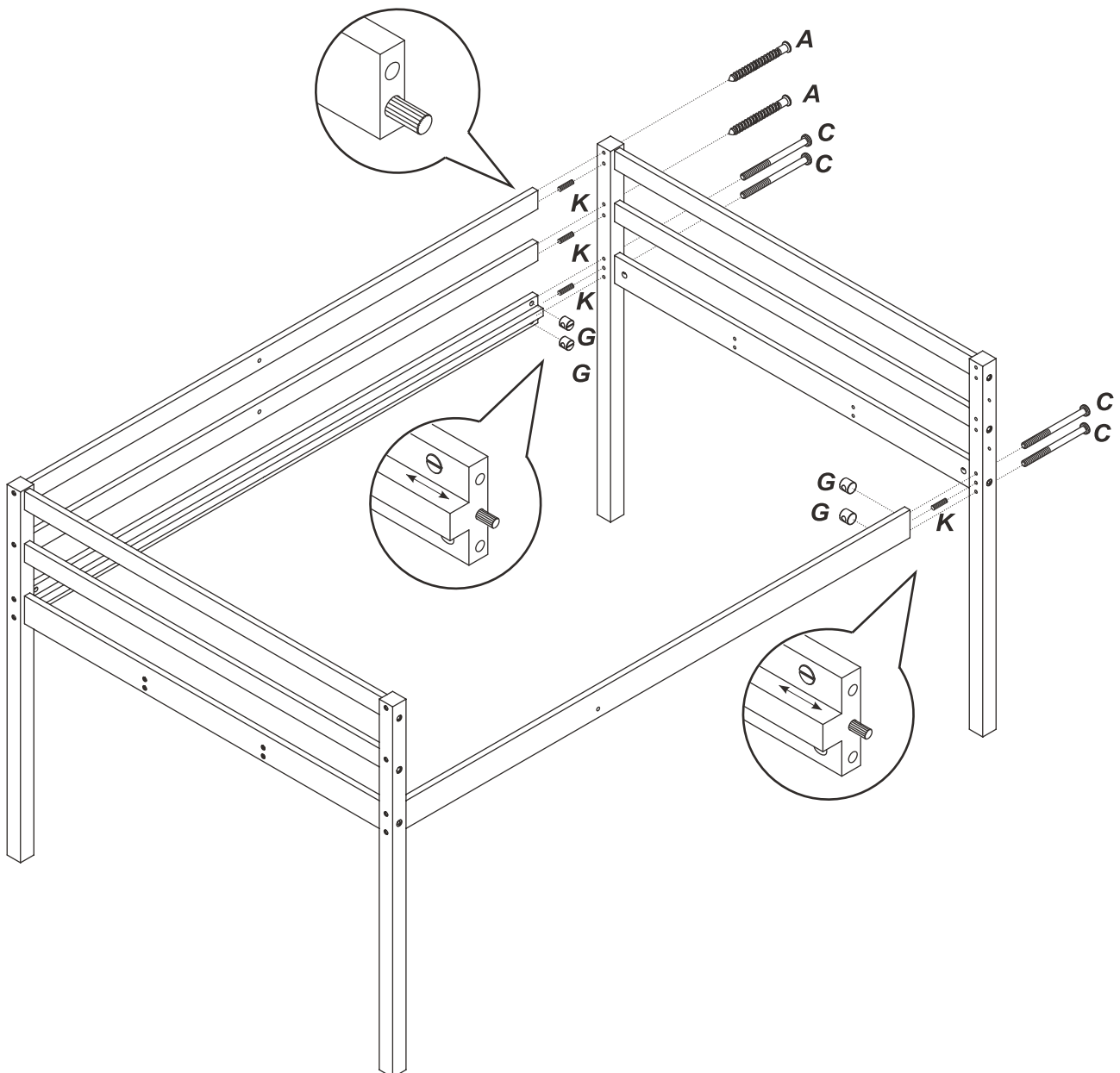

# ASSEMBLY STEPS

New panels & accessories needed in below step

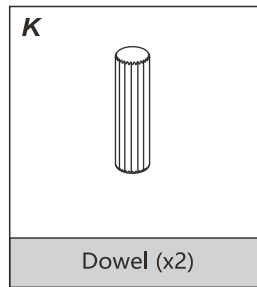
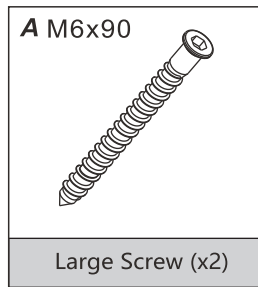
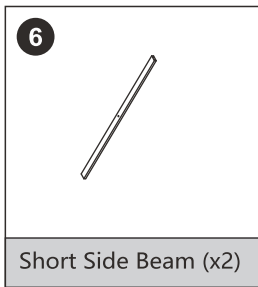

## STEP 4

Insert dowels K into #6 short side beam, then insert them into bed leg and fasten short side beam to bed leg with screw A.

Attention: the short side beam can be fixed to headboard or footboard's leg, depending on where you want to put the ladder.

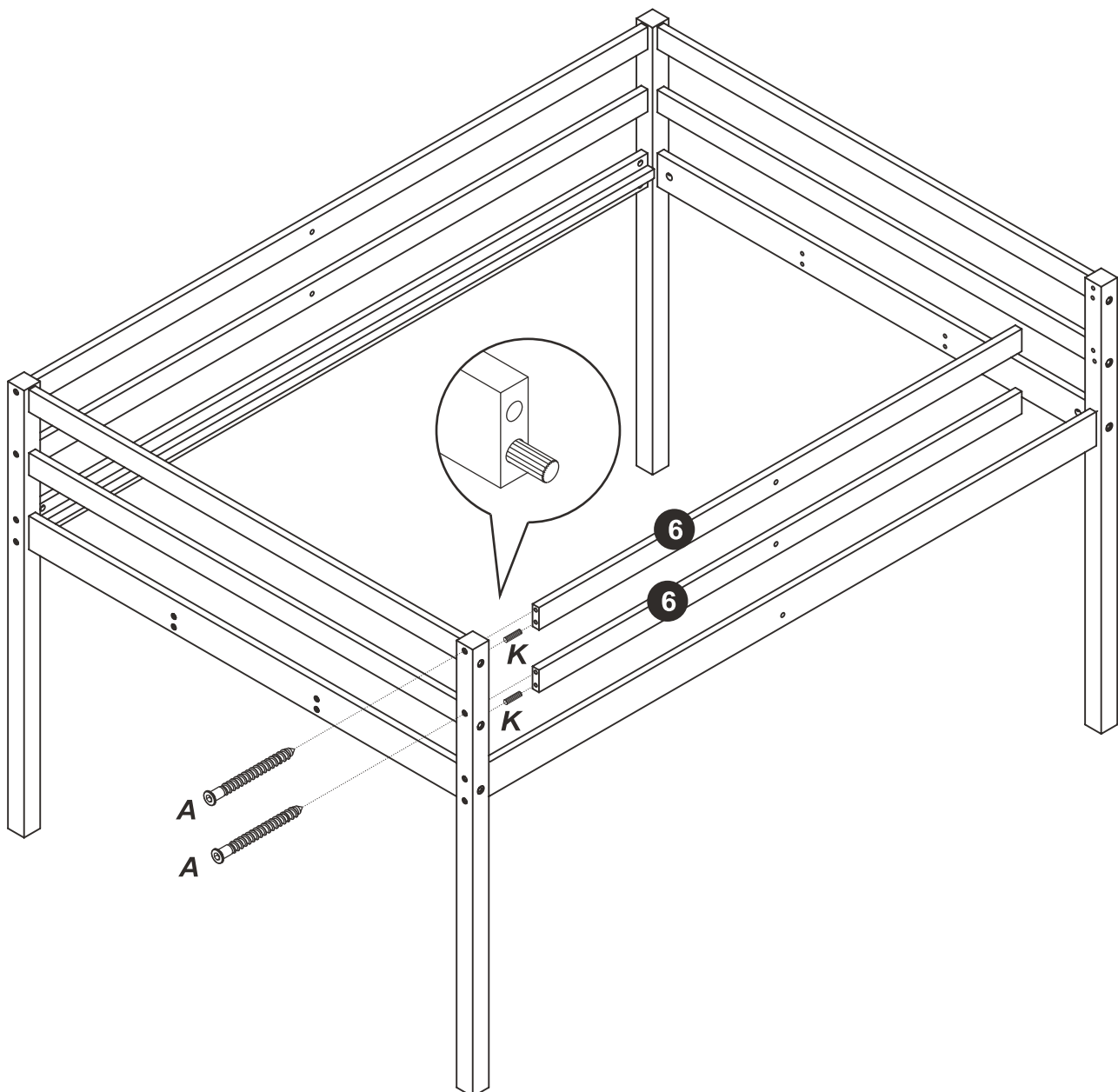

# ASSEMBLY STEPS

New panels & accessories needed in below step

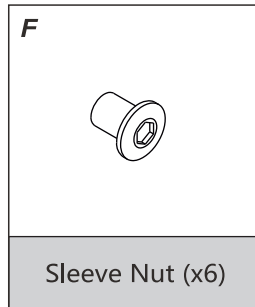
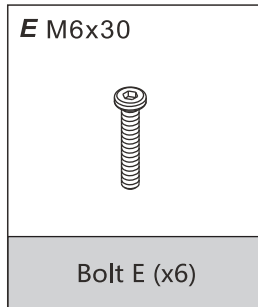
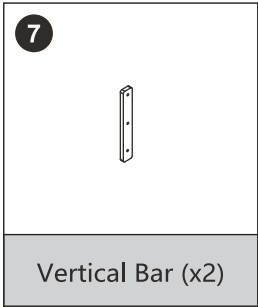

## STEP 5

Use bolt E and sleeve nut F to install #7 vertical bar onto the side beam.

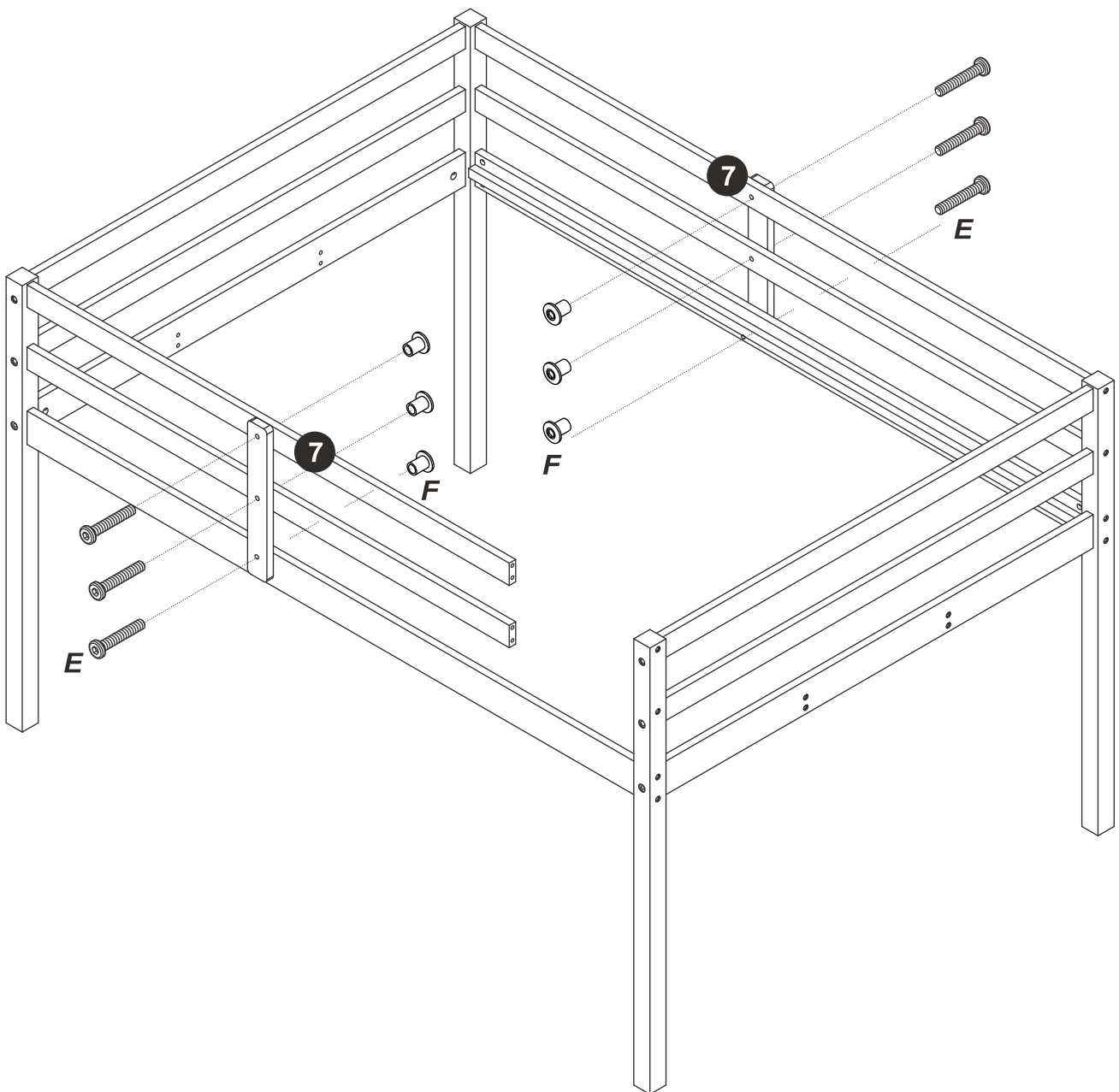

# ASSEMBLY STEPS

New panels & accessories needed in below step

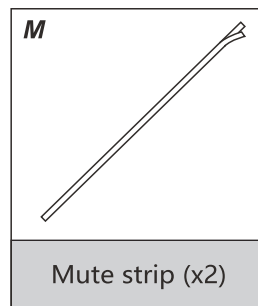
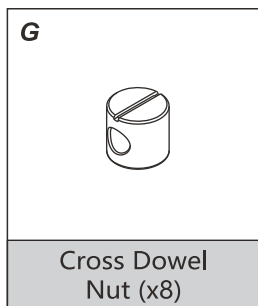
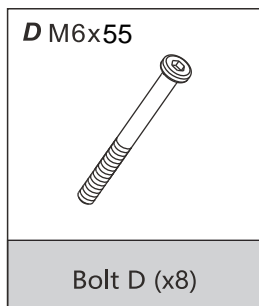
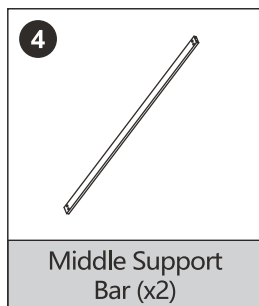

## STEP 6

Put cross dowel nuts G into #4 middle support bar and place the bar side up, then fasten #4 middle support bar to headboard with bolt D. Mute strip M can be pasted on #4 middle support bar by tearing off its adhesive tape upon demand.

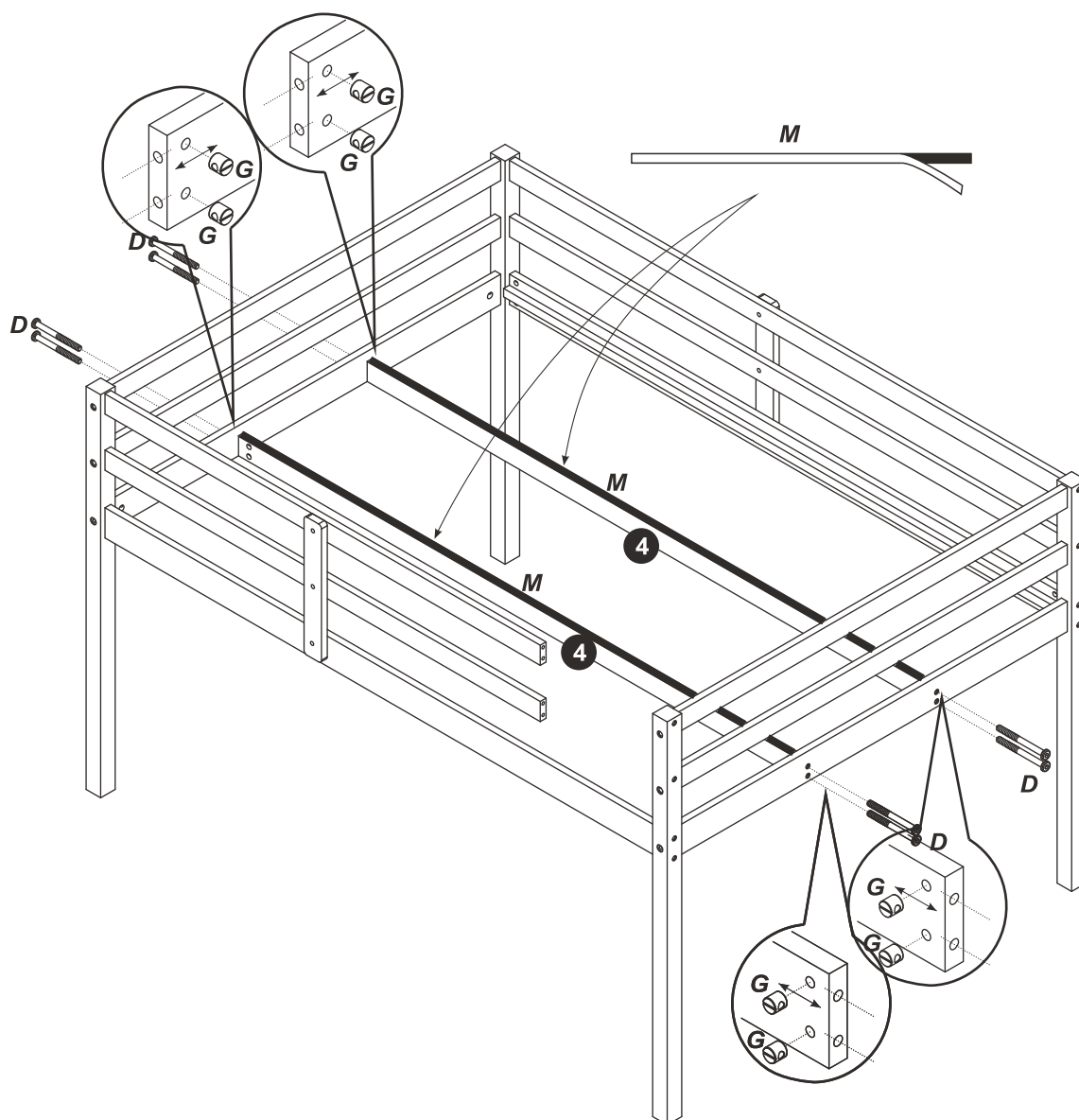

# ASSEMBLY STEPS

New panels & accessories needed in below step

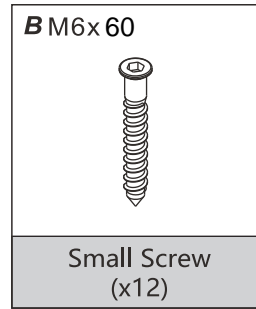
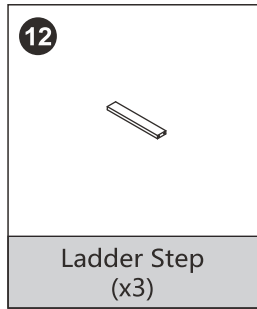
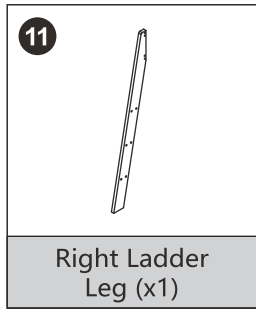
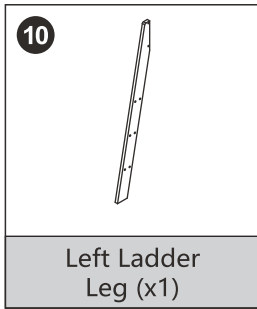

## STEP 7

Fasten #12 ladder step to #10 and #11 ladder legs with screw B.

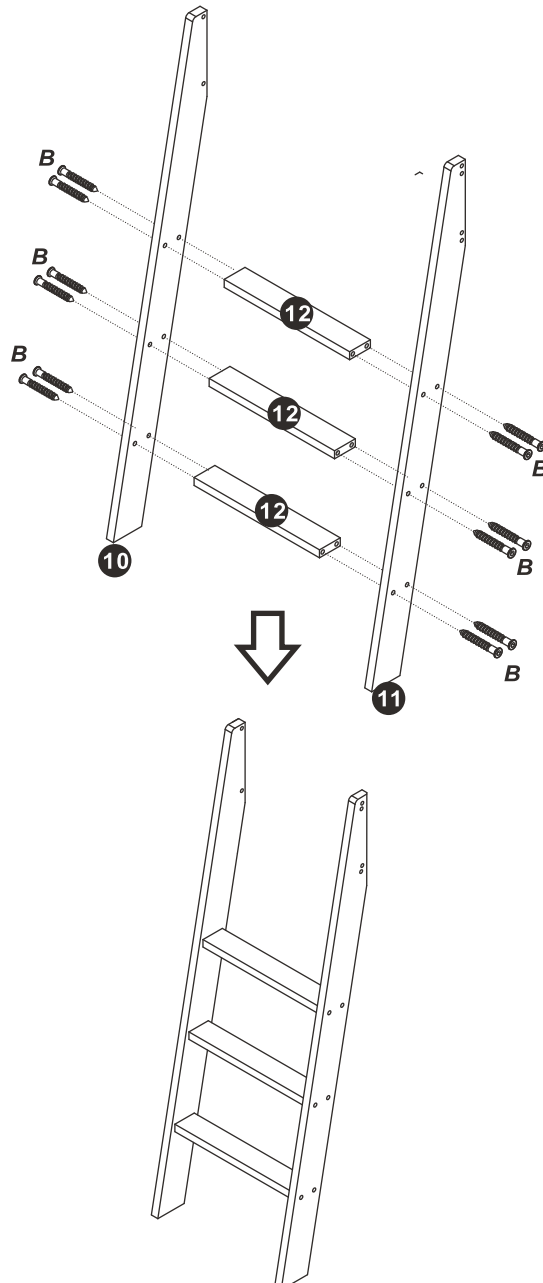

# ASSEMBLY STEPS

New panels & accessories needed in below step

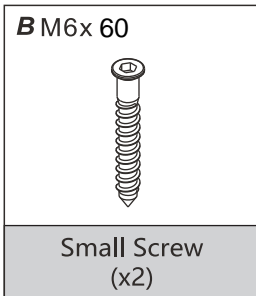
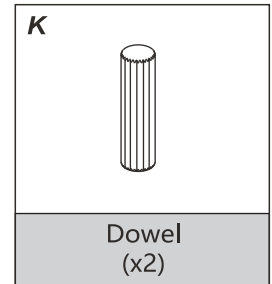
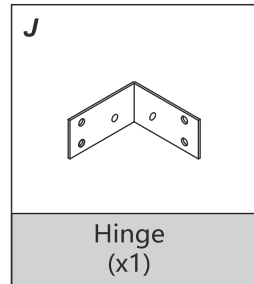
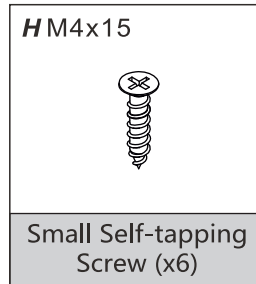
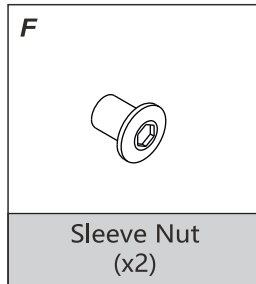
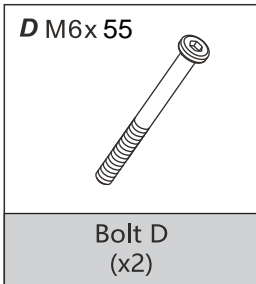

## STEP8

Fix ladder to the position you want on the bed:

- a: Insert dowels K into short side beam, then use screw B to connect the beam to ladder leg;
- b: Fix hinge J to ladder with screw H;
- c: Fasten ladder to bed leg with bolt D and sleeve nut F.

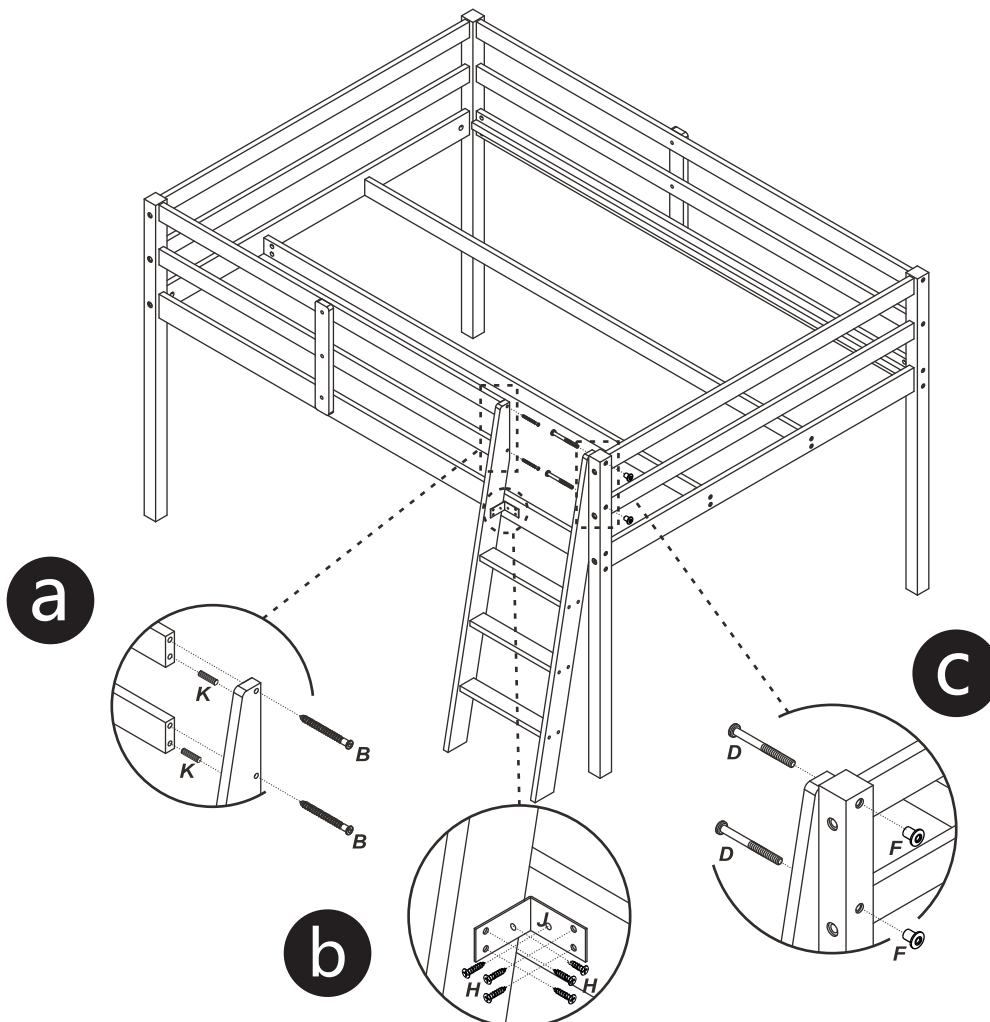





# MAXIMUM LOADS

This unit has been designed to support the maximum loads shown. Exceeding these load limits could cause sagging instability, collapse, and serious injury.

Load-bearing:  
**551lbs / 250kg**



# FAQs

## **1. What should I do when there are accessories or hardware missing?**

Pls feel free to contact VINGLI customer service via [www.vingli.com](http://www.vingli.com) with your order ID, the quantity, and corresponding listing number of missing part. We will send out for you as soon as possible.

---

## **2. What should I do when I received a damaged item?**

Pls feel free to contact VINGLI customer service via [www.vingli.com](http://www.vingli.com) with your order ID, picture of defective part to us, and we will solve for you at once.

---

## **3. What should I do when the bed feel wobbly?**

- a. make sure each panel has been connect to each other properly, and all screws have been tighten after assemble
- b. find out that wobbly part, and if it is the screw cannot tight, you can try to add on a washer to help
- c. if still not work, pls feel free to contact our customer team with the wobbly part detail, and we will solve for you



Share your shopping experience with friends and families.  
Like “ VINGLI” on Facebook for more Amazon deals & promotions.



## Get Free Products!

If your advice on either our product or instruction is taken, a free gift will be provided!



For any questions or feedback, please email us with your order ID.  
We are always striving to improve.

✉ [support@vingli.com](mailto:support@vingli.com)

🌐 [www.vingli.com](http://www.vingli.com)