



Assembly Instruction



Please read these instructions carefully and ensure that they are followed at all times.

If you need help or have questions about your order, please contact our support team at support@vingli.com

We hope you never have the need, but if you do, our service is friendly and hassle-free.

Door canopy

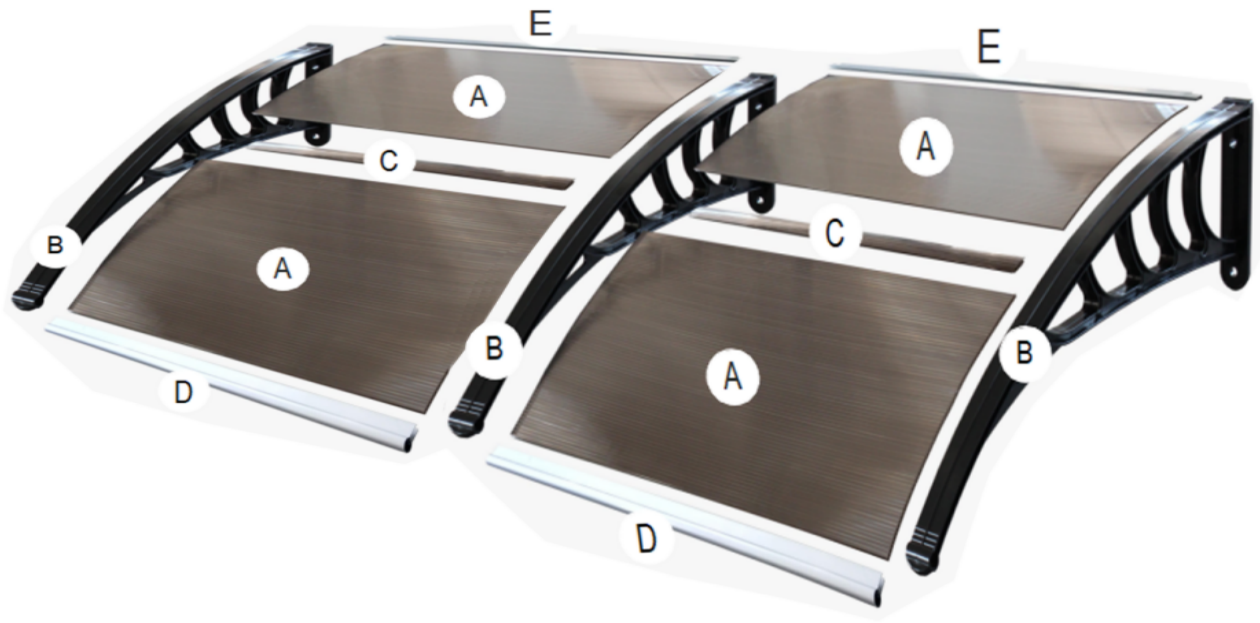

A	4 x	PC Board	
B	3 x	Bracket	
C	2 x	H Bar	
D	2 x	Front Bar	
E	2 x	Back Bar	
F	4 x	Screws	
G	8 x	Sharp Screws	
H	6 x	Screwset	

1

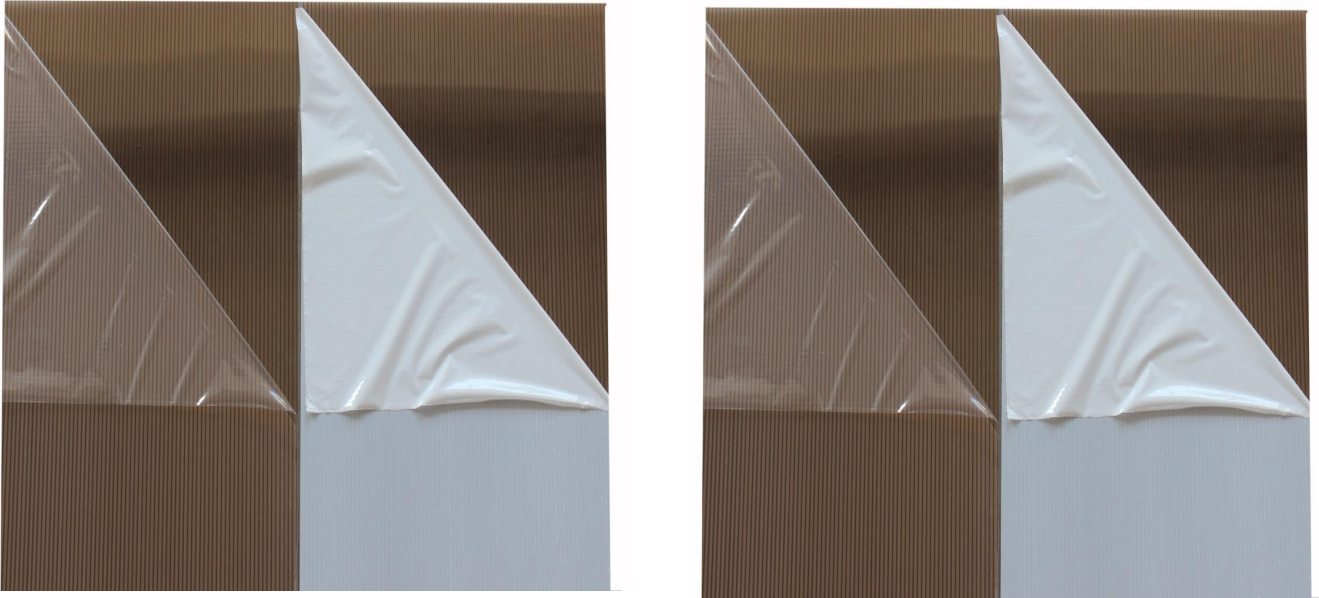

1. Take out 4 of accessory A and tear off the protective film

2

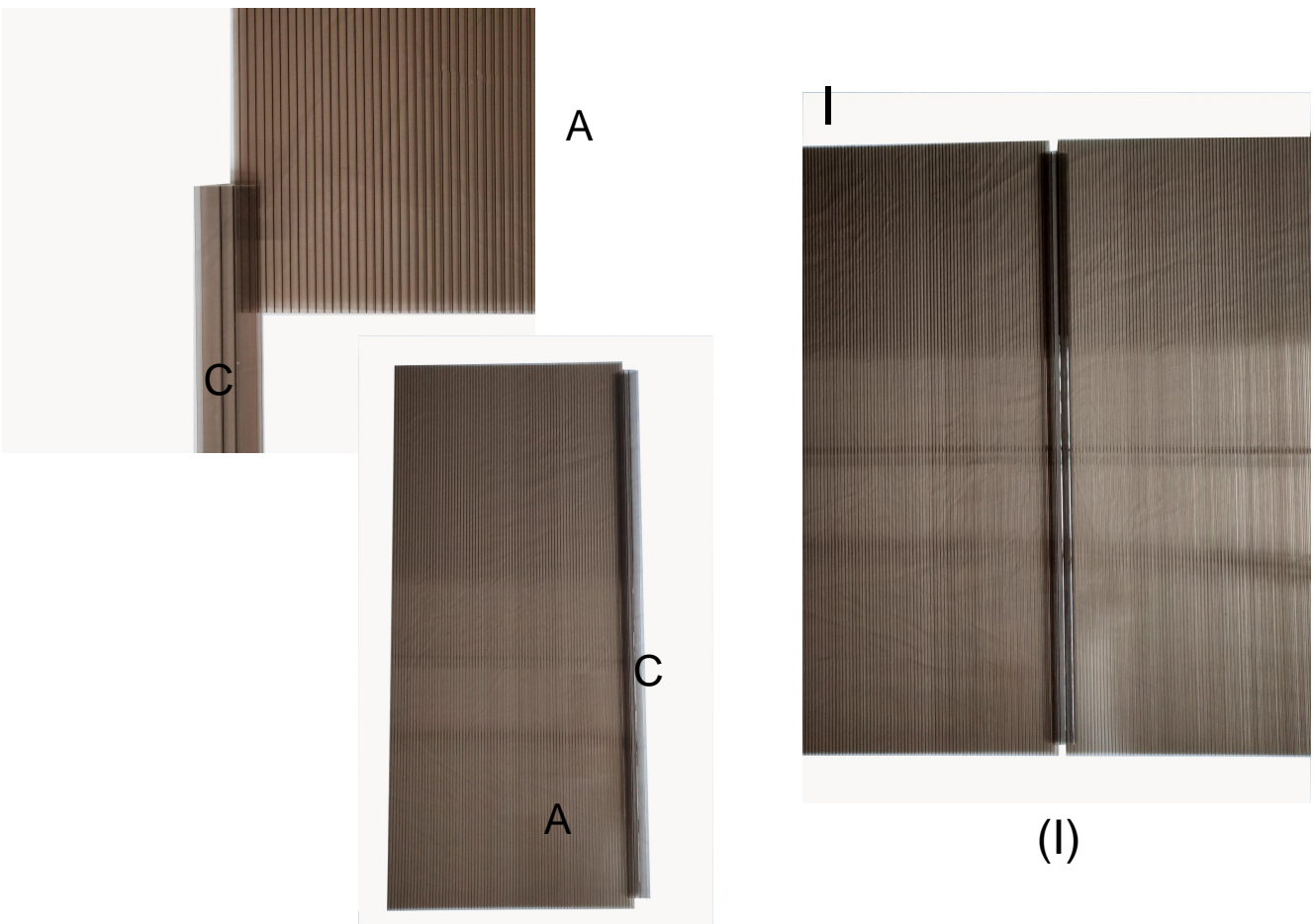

2. Accessory C should be fixed in the middle of 2 accessory A.
Take out accessory C and secure the accessory A with accessory C (become I)

3



(J)

3.Take out accessory B and accessory E, and connect the accessory E into the accessory B become J

4

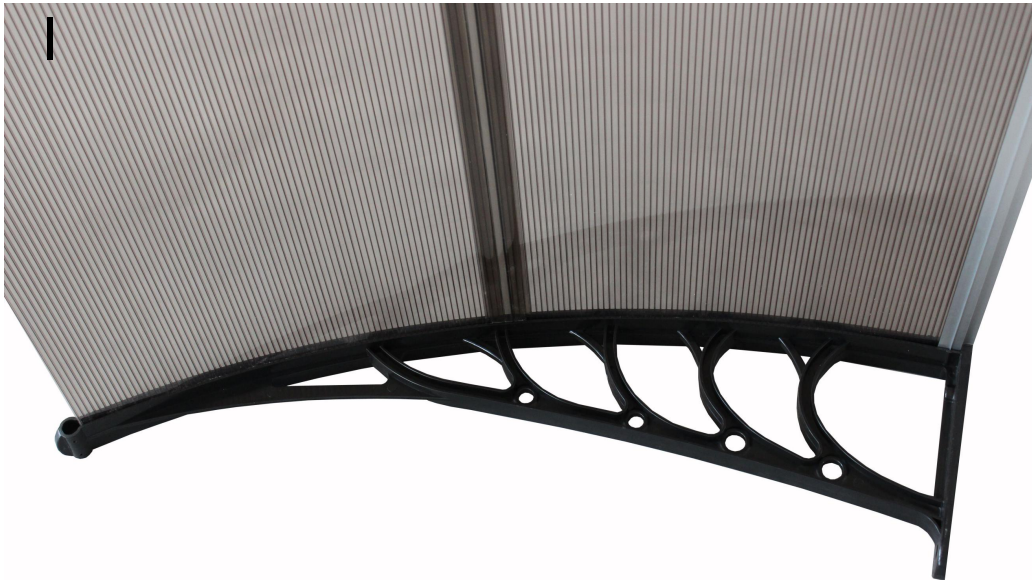

(K)

4.Fix (I) to the (J) (become K) (Note: the I can be set diagonally to the J)

5

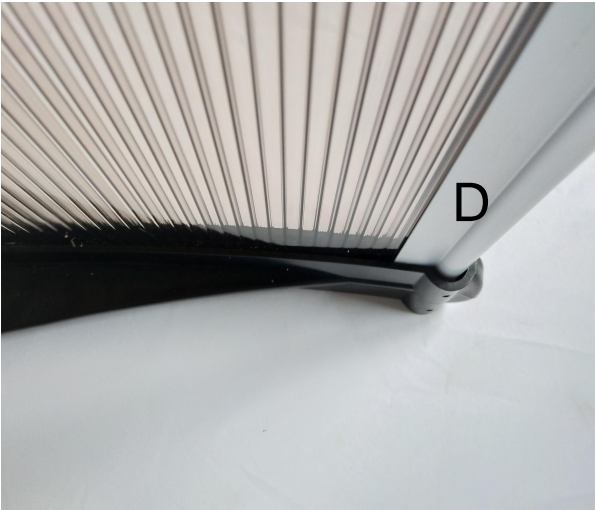

(L)

5. Based on the fourth step, take out the accessory D and fix accessory D to the (K) (become L)

6



6. Take out 2 of G (sharp screws) fix to the (L)

7



7. Take out another accessory B and fix to the (L)

8. Take out another 2 of G (sharp screws) and fix to the (L)

9

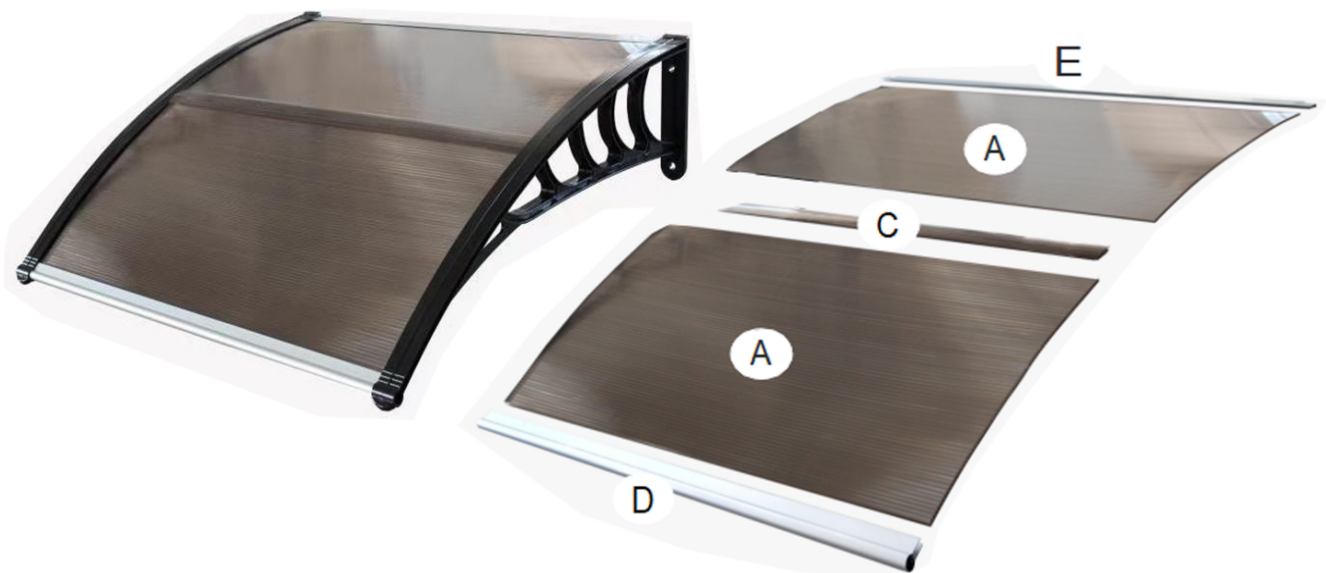

9. Repeat to assembly another (I) with (L) and insert D+E

10

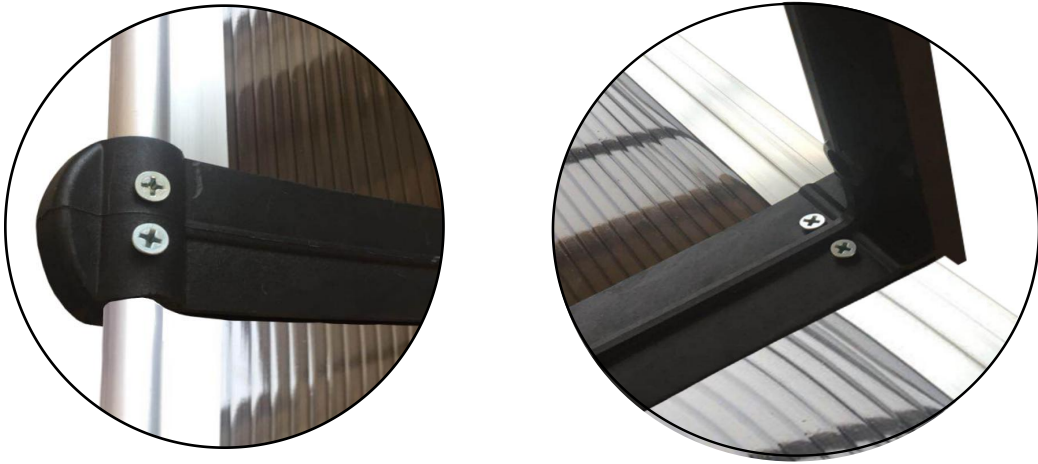

10. Take out another 2 of G (sharp screws) and fix to the (L)

11

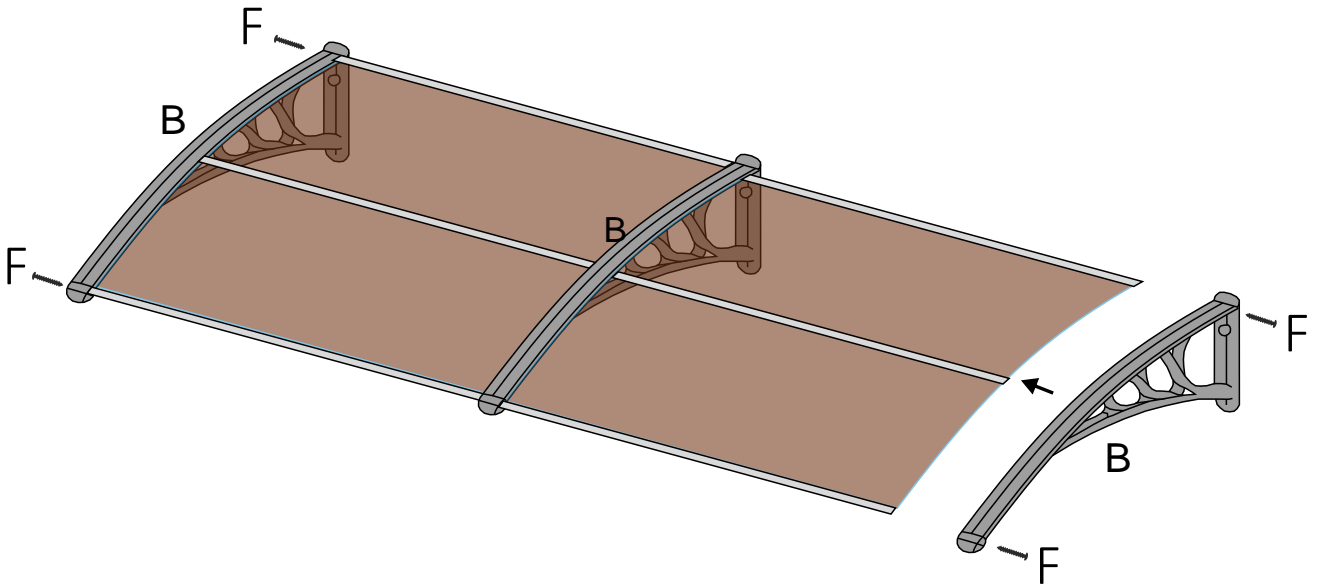

11. Take out another accessory B and fix to the (L)

12. Take out another 4 of F (long screws) and fix to 2 (B)

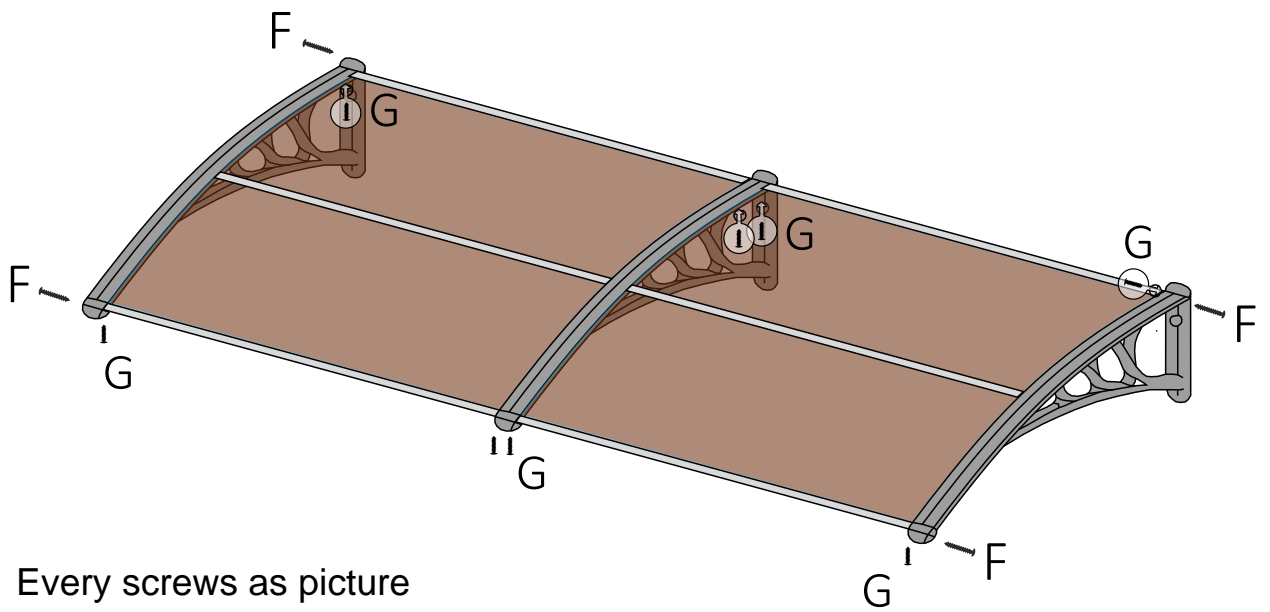

Every screws as picture

12



Take out 6 of H (screwset) and fix the awning into the wall by the 6 of H(screwset)