



ASSEMBLY INSTRUCTION













Customer Service

If there are missing part or broken parts, or if you need futher assistance,please contact customer service online via email:
support@vingli.com

Notice:

1. 50% Tighten before fixing all screws.
2. Place the item on a flat ground to adjust and make sure it remains stable.
3. Tighten up all screws with tools gradually.
4. If the screws are not aligned with holes during assembly, please loosen all the other screws to 50% and continue the assembly process.
5. If the item is not stable, please loosen all the screws, adjust it on a flat ground and tighten up all screws again.

No	Picture	Parts	Qty
A		Table top	1
B		leg	4
C		Leg Support	2
D		Stud M8*45	4
E		Screw M8*50	16
F		Flat Washer (8mm)	20
G		Spring Washer (8mm)	20
H		Nut (8mm)	20
I		Protective Cap	16
J		Wrench	1
M		Screwdriver	1

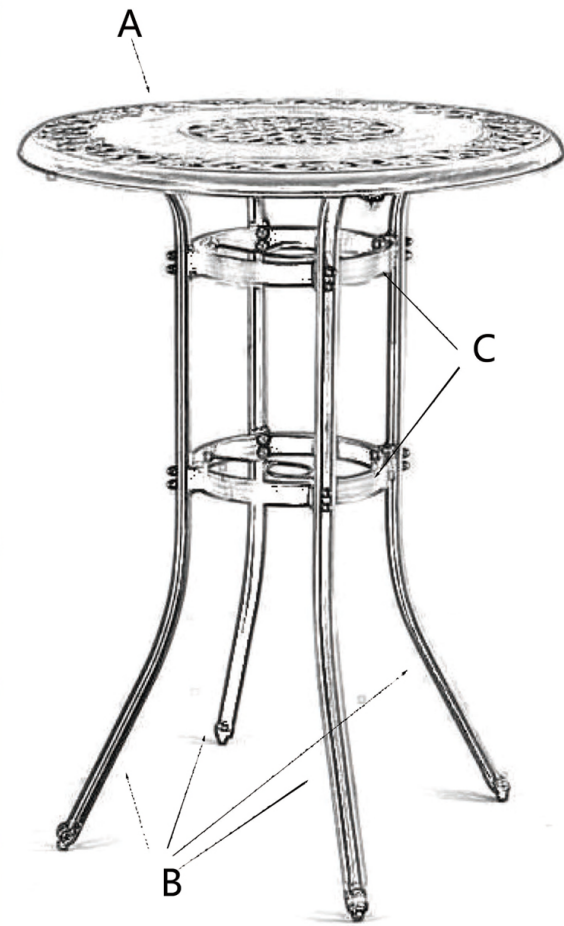

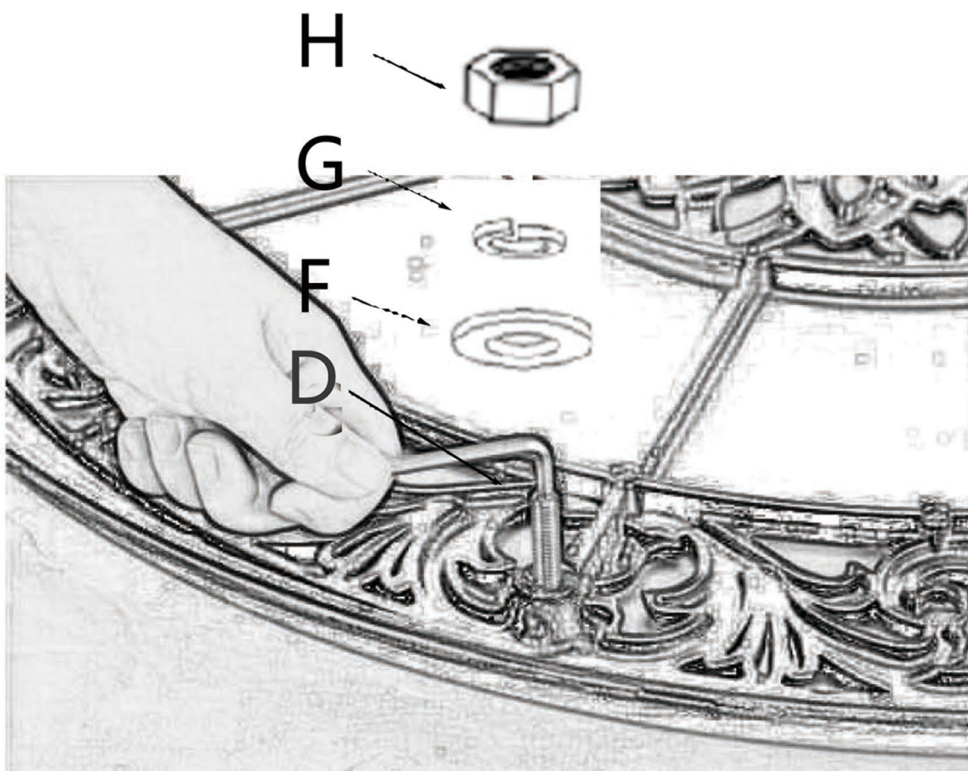

Screw D in and insert the leg. Then put F,G,H on. Please note that don't tighten the screw until you finish the assembly.

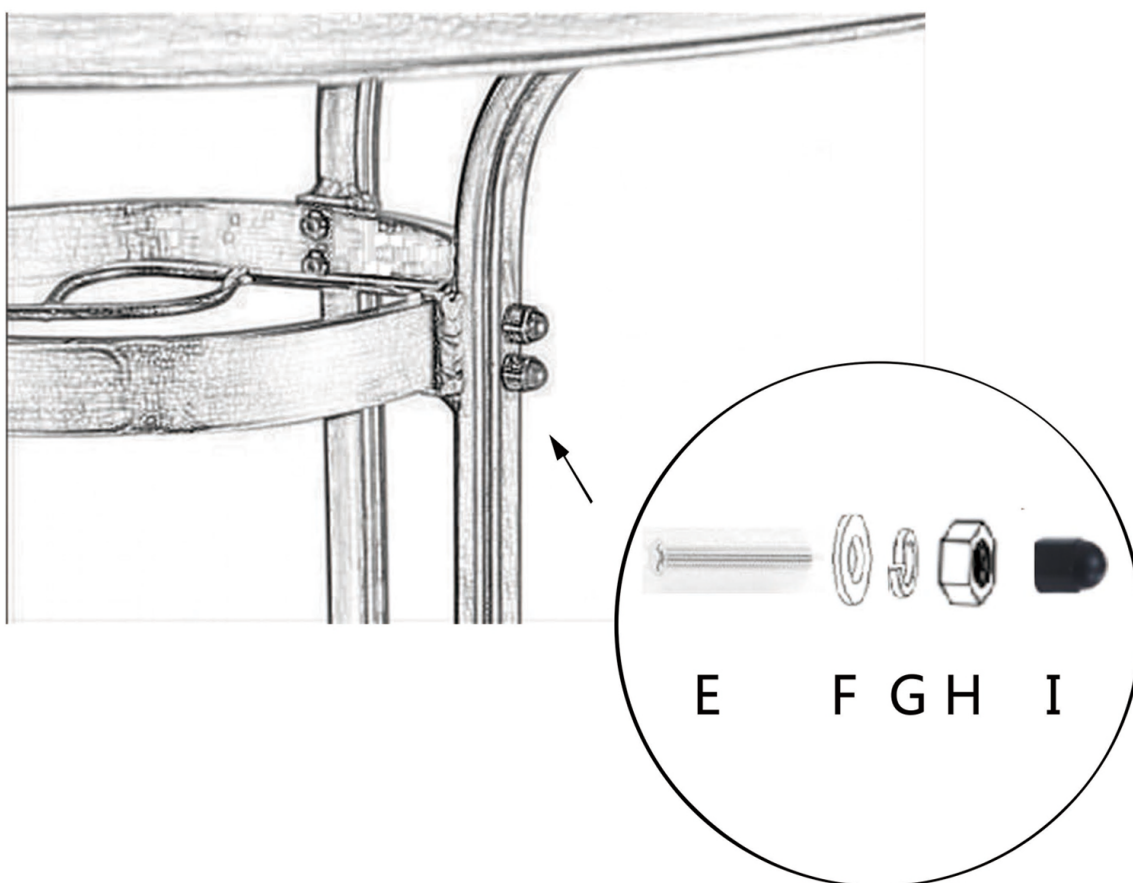

Please note that don't tighten the screw until you finish the assembly.