



INSTRUCTION

INSTALLATION VIDEO



[HTTPS://WWW.YOUTUBE.COM/WATCH?V=OPQZ-VDHO_ZS&FEATURE=YOUTU.BE](https://www.youtube.com/watch?v=OPQZ-VDHO_ZS&feature=youtu.be)

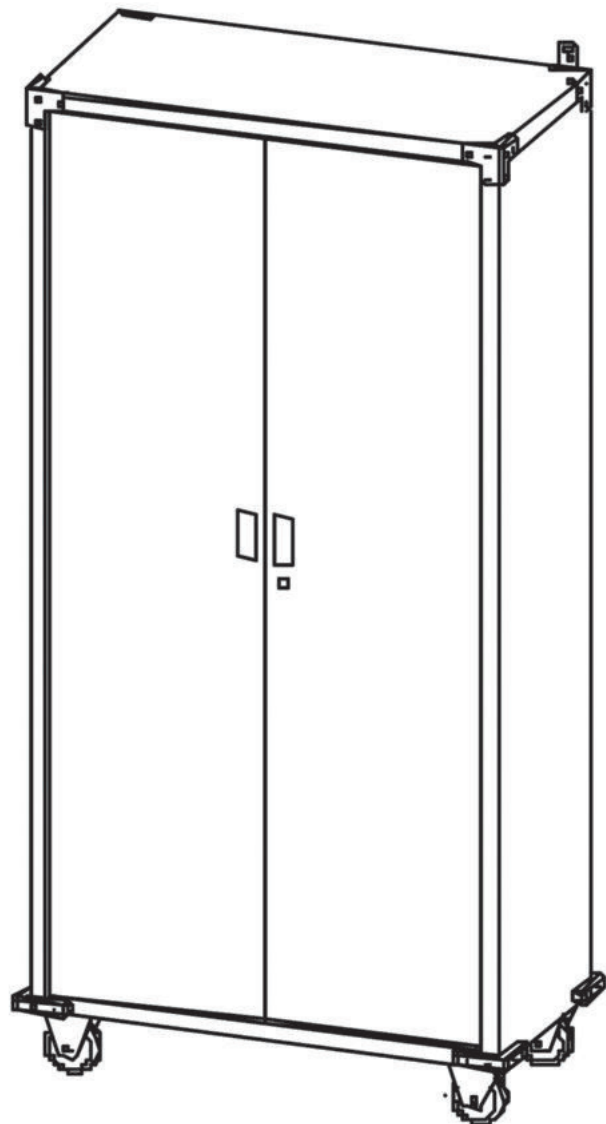

Thank you for your purchase.

Please contact us if you have difficulty with assembly or need replacement parts.

Bonnlo Customer Service is here to assist you.

Email: support@vingli.com

Please attach your User Name or Order ID so that we can assist you better.

Note: Each cabinet ships in two boxes.

Introduction

Guide of Manual

- Please read the following instruction carefully and use the product properly.
- Please keep this manual and hand it over when you transfer the product.
- Please contact us when further information and help needed.

Notes

- Make sure to start on the correct instruction page for the cabinet you are assembling.
- Unpack parts and hardware carefully to prevent scratching of lacquered components.
- Please assemble the product according to the steps on the diagram strictly.
- Do not fully tighten the screws until all pieces are situated in place.
- For continued use, it's suggested you regularly check the tightness of bolts and connections to ensure safety.
- Do not assemble and disassemble the product repeatedly to avoid damaged.
- To avoid confusion keep all parts and hardware together with the boxes that they came in; Note:Each cabinet is divided into two packages.

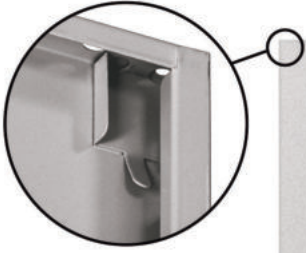

↑
UP



7

Left door

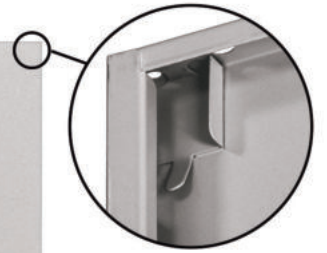

↑
UP



8

Right door



UP



②

Left side panel

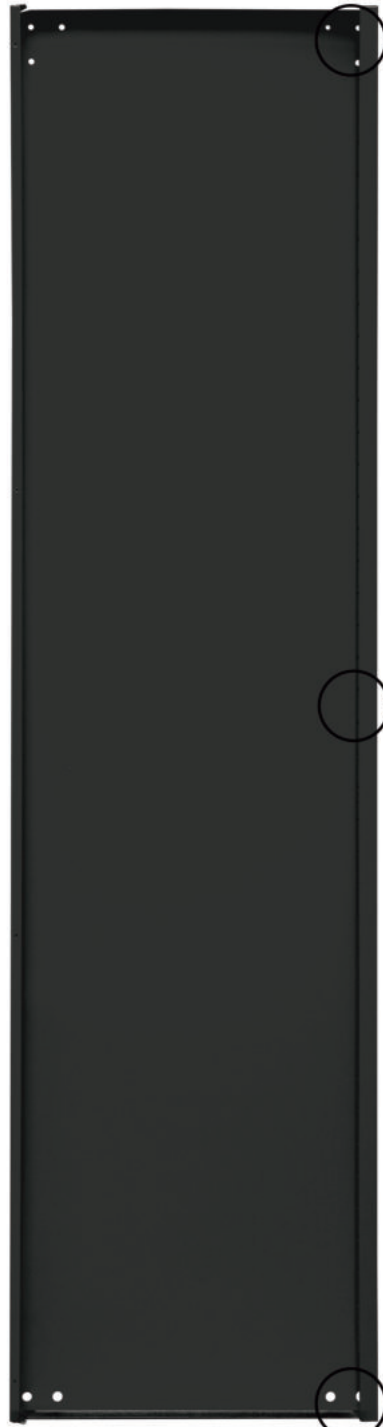

③

Right side panel



UP

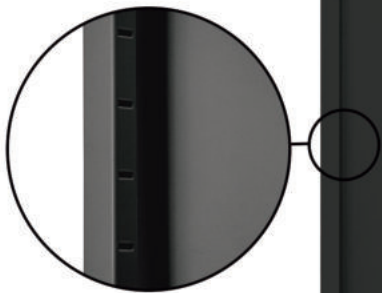

FRONT

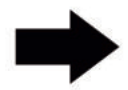
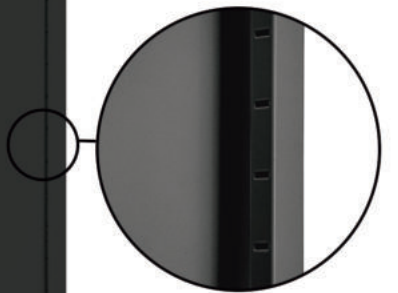

FRONT

DOWN



DOWN



UP

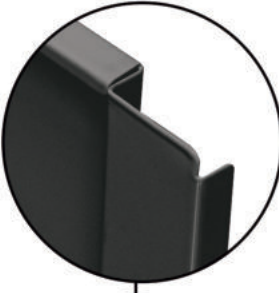
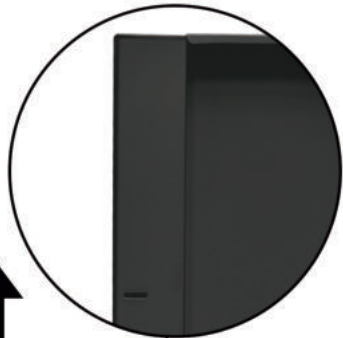

UP



6

Left back panel

5

Right back panel

DOWN

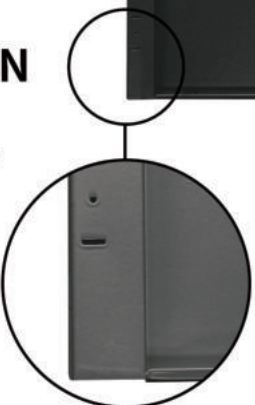

DOWN

1

Top panel

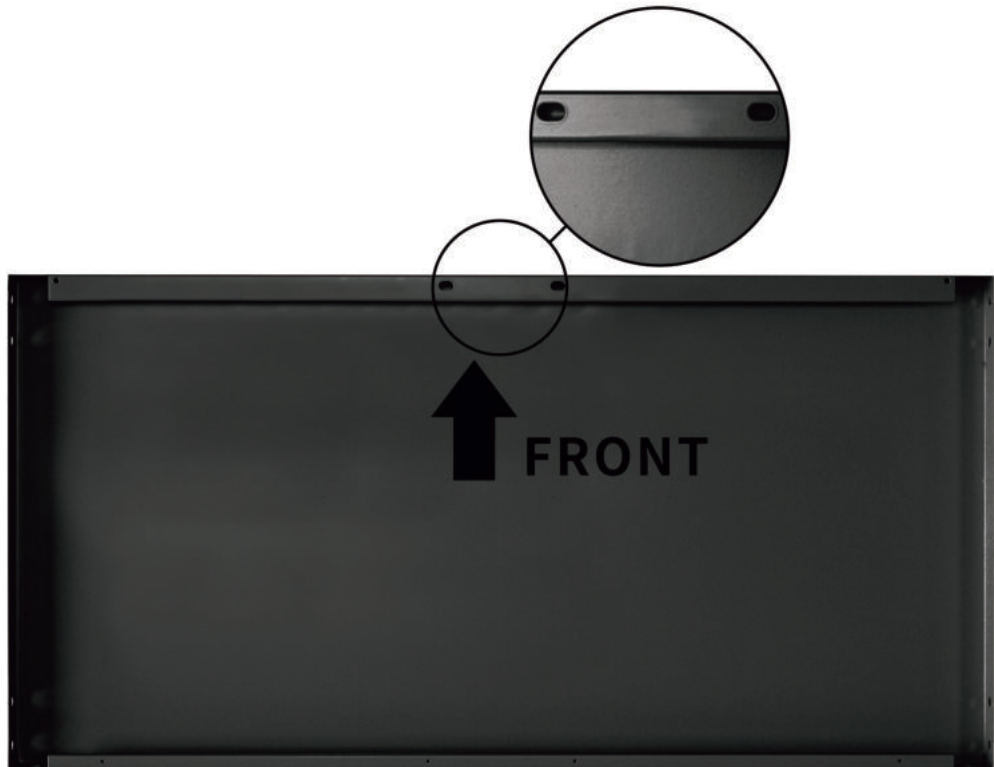

4

Bottom panel

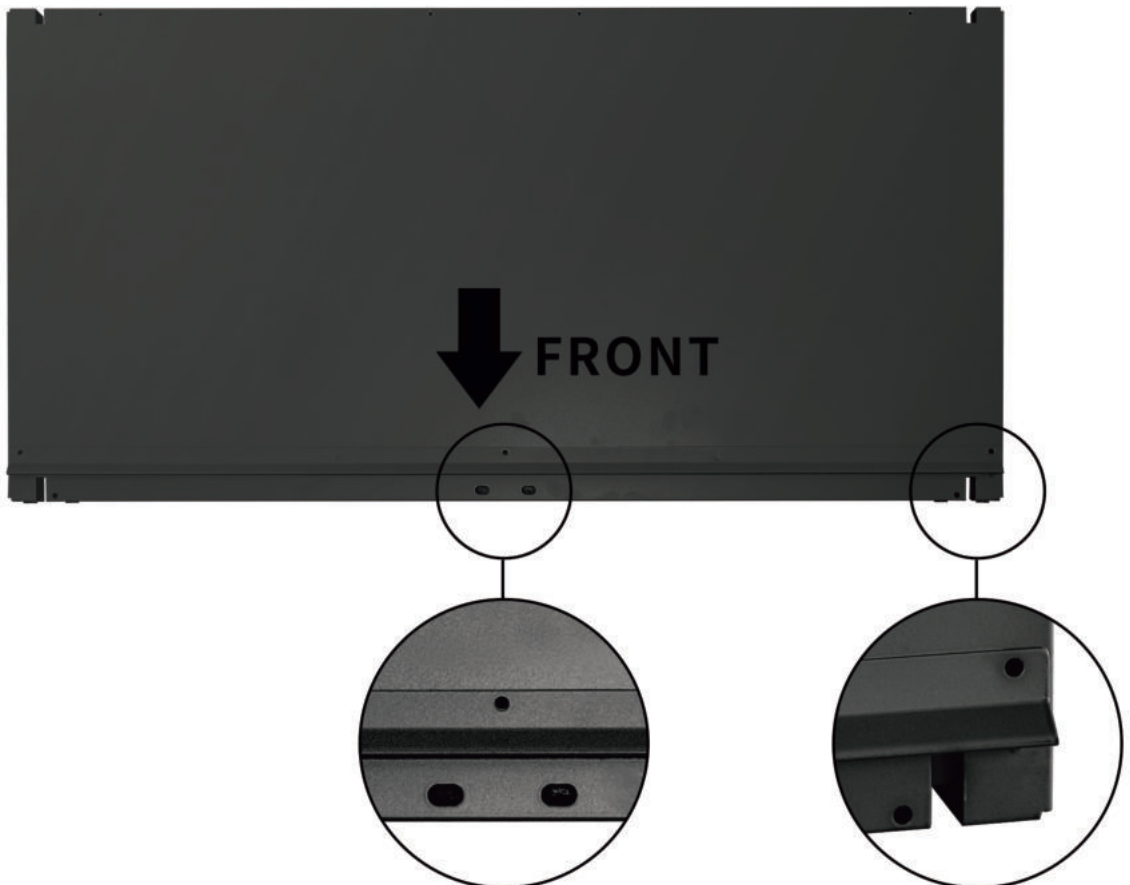

9

Shelf



A



D



E



E



G



F



H



C









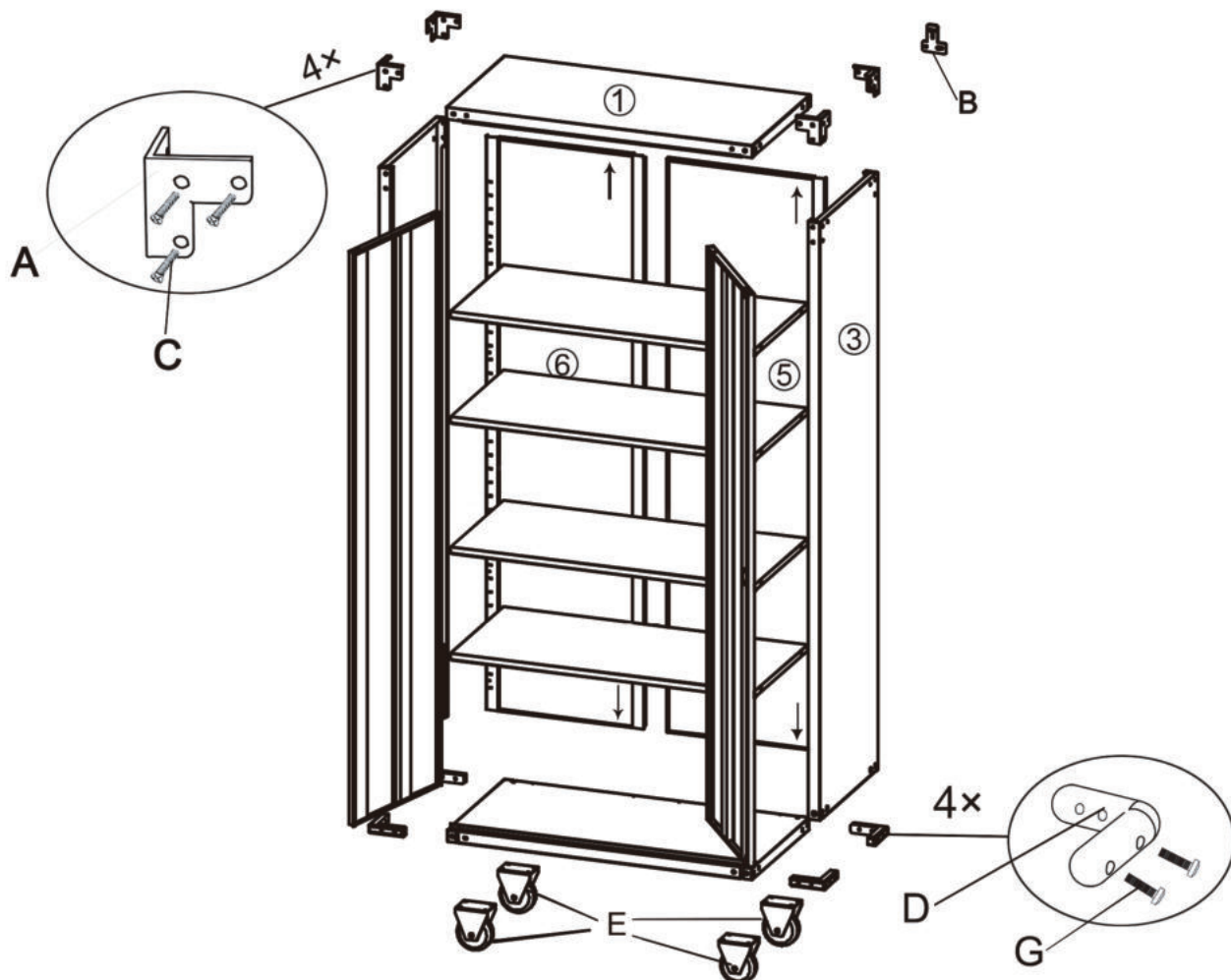





B+M



L+I+J+K



Accessories list:

CODE	HARDWARE	QTY	CODE	HARDWARE	QTY
A	 Iron corner	4	H	 Black tapping screws	20
B	 Hanging accessory	2	I	 Short heel post	2
C	 6*12 countersunk nut bolts	24	J	 Heel post gasket	2
D	 Corner protector	4	K	 L-shaped door post	2
E	 Wheel	4	L	 Shelf clasp	16
F	 6*15 countersunk bolts	16	M	 Nails	2
G	 6*25 round head bolts	16			

Step1



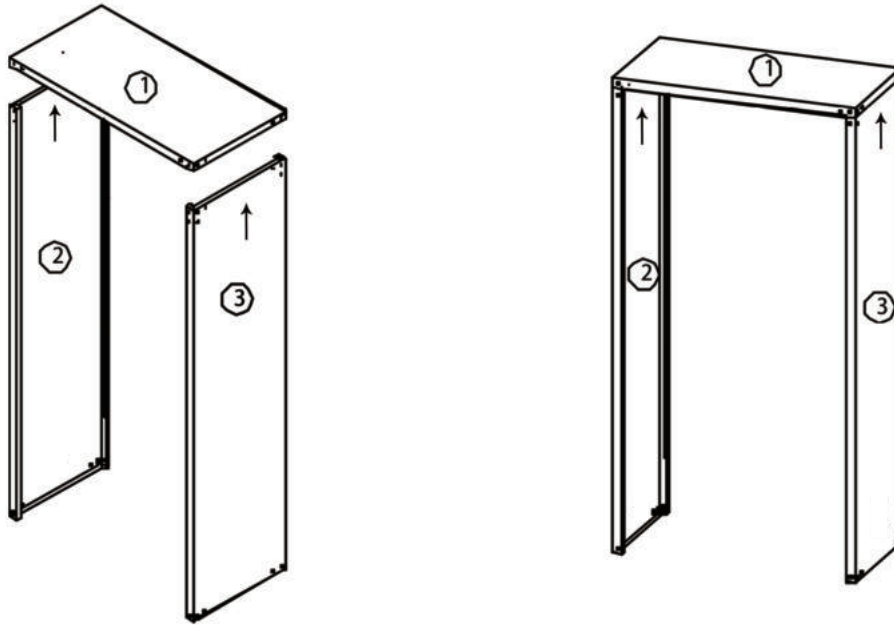

Install the left side panel(2), right side panel(3) and top panel(1)
 Pay attention to distinguish the front and rear of the panels.
 The front of the side panels with the adjustable holes, and the front of top board with edgefold.

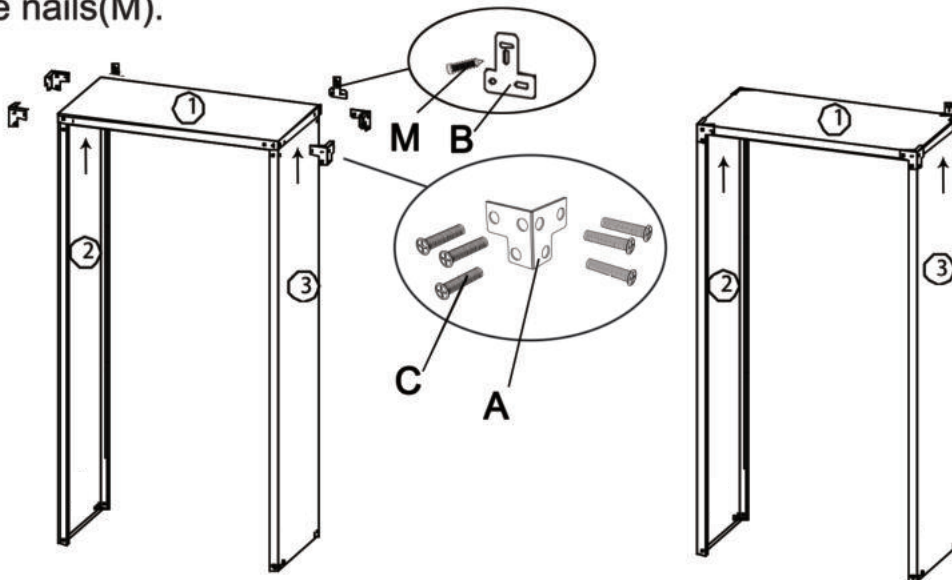

Step2

Install 4 iron corners(A).Each corner need 6x15countersunk nut bolts(C) 6pcs.
 If need to fix the cabinet to the wall,please install hanging accessories (B),
 and use nails(M).



CODE	HARDWARE	QTY	CODE	HARDWARE	QTY
A	 Iron corner	4	C	 6 *12countersunk nut bolts	24
B	 Hanging accessory	2	M	 Nails	2

Step3

Install the bottom panel(4) Note to install the front first, then the rear.

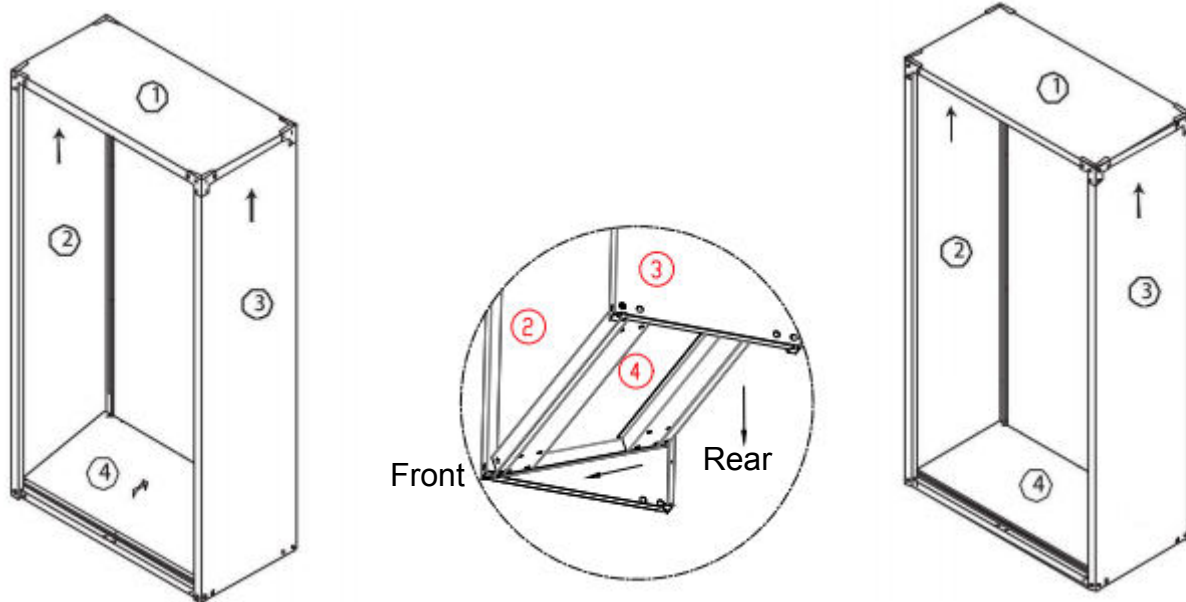



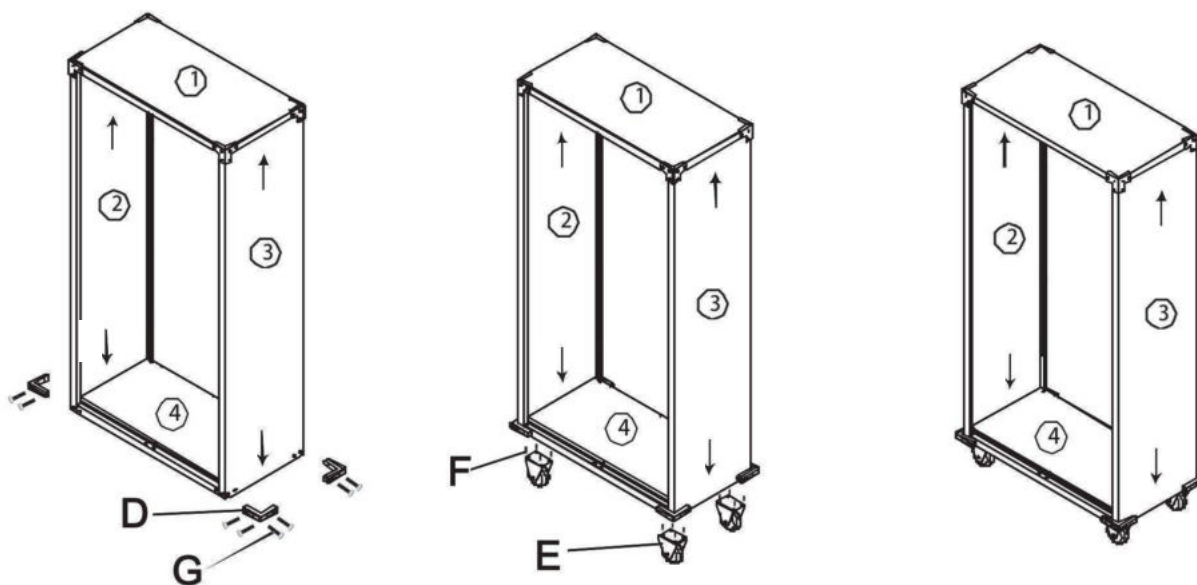

Step4

Install 4 corner protectors(D), total need 6x25 round head bolts(G) 16pcs.

Install 4 wheels(E), total need 6x15 countersunk bolts(F) 16pcs.



CODE	HARDWARE	QTY	CODE	HARDWARE	QTY
E	 Wheel	4	F	 6*15 countersunk bolts	16
D	 Corner protector	4	G	 6*25 round head bolts	16

Step5

Install right back panel(5), need black tapping screws(H) 8pcs. Install left back panel(6), need black tapping screws(H) 12pcs.

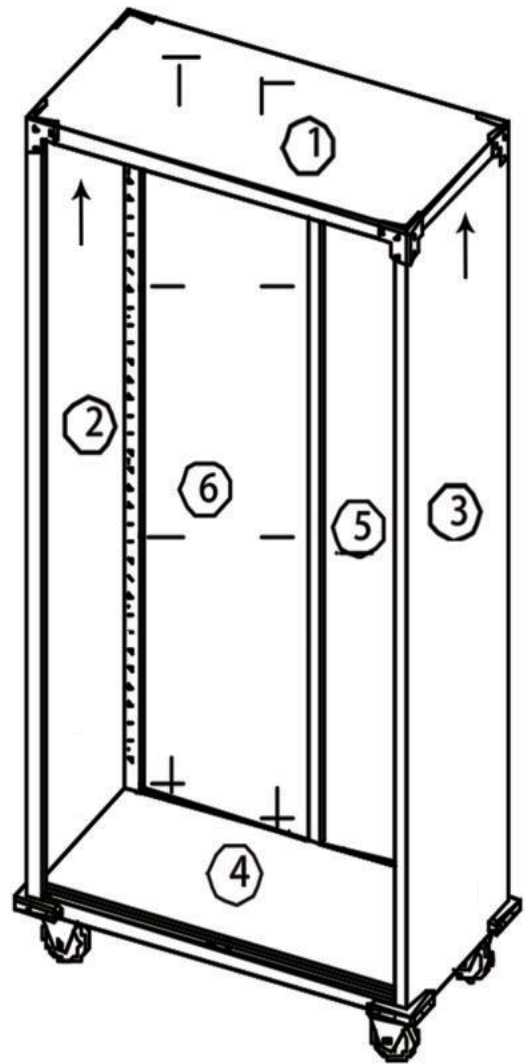
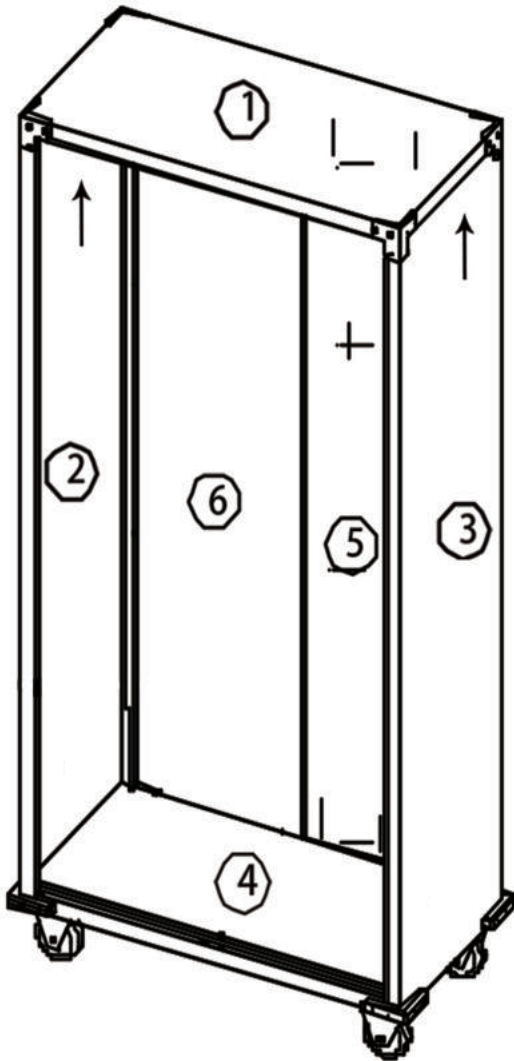

CODE	HARDWARE	QTY
H	  Black tapping screws	20

Step6

There is a hole above and below each door. And a hole above and below each side of the cabinet.

Step 1: Place a gasket(J) and a short post(I) on the hole which below the cabinet, then put the door on the short post(I).

Step 2: Make sure the hole on the top of the door and the hole on the top of the cabinet are aligned, then insert the L-shaped door post(K) with the two holes. To make sure the L-shaped door post(K) won't drop down, bend the metal piece to suitable position.

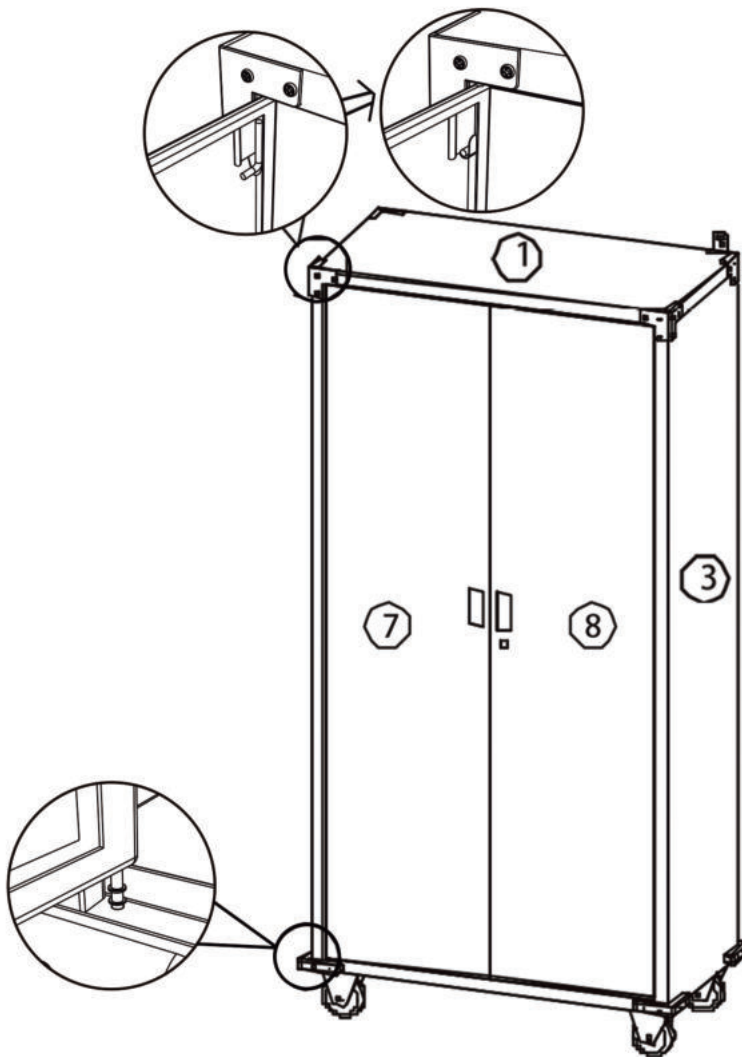

CODE	HARDWARE	QTY
I	 Short heel post	2
J	 Heel post gasket	2
K	 L-shaped door post	2

Step 7

Install 3 shelves(9).Each shelf(9) need shelf clasp(L) 4 pcs.

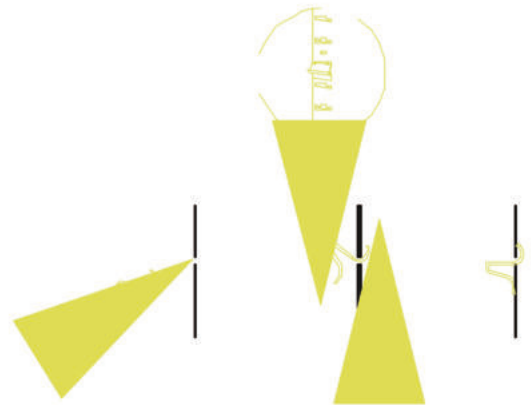
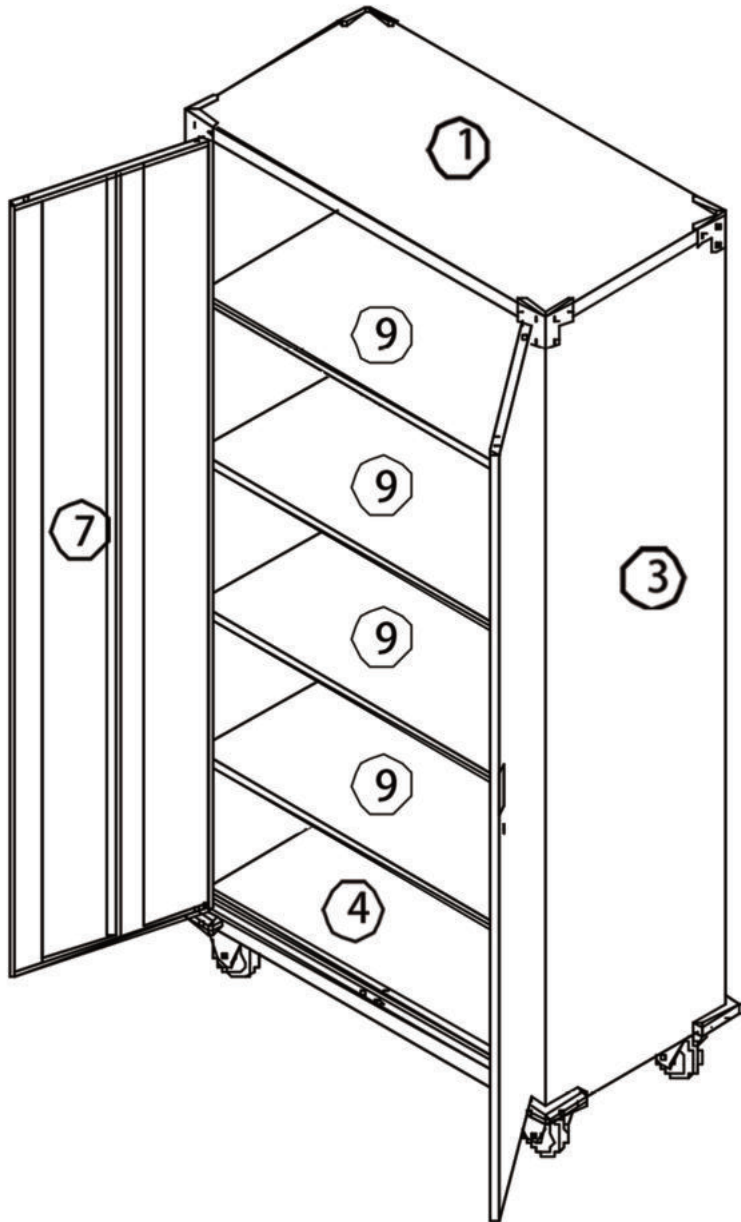

CODE	HARDWARE	QTY
L	 Shelf clasp	16



INSTRUCTION

INSTALLATION VIDEO



[HTTPS://WWW.YOUTUBE.COM/WATCH?V=OPQZ-VDHO_ZS&FEATURE=YOUTU.BE](https://www.youtube.com/watch?v=OPQZ-VDHO_ZS&feature=youtu.be)

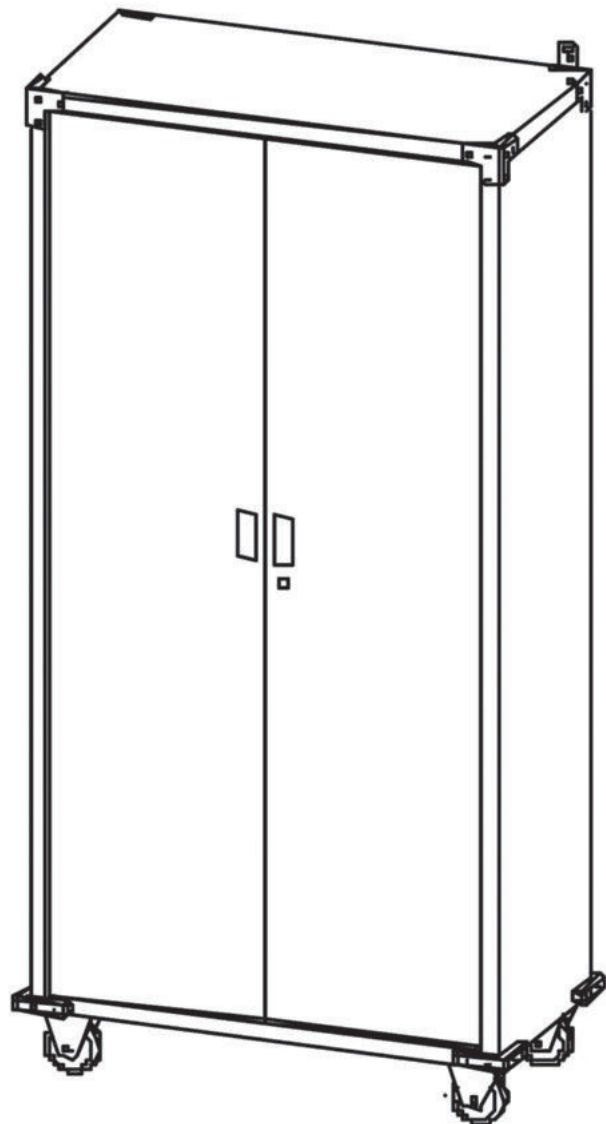

Thank you for your purchase.

Please contact us if you have difficulty with assembly or need replacement parts.

Bonnlo Customer Service is here to assist you.

Email: support@vingli.com

Please attach your User Name or Order ID so that we can assist you better.

Note: Each cabinet ships in two boxes.