



## **Mirrored Cabinet**



**Thank you for your purchase.**

**Please contact us if you have difficulty with assembly or need replacement parts.**













**Vingli Customer Service is here to assist you.**

**Email:[support@vingli.com](mailto:support@vingli.com)**

**Website:[www.vingli.com](http://www.vingli.com)**

**Please attach your User name or Order ID so that we can assist you better.**

## Hardware List

<b>A</b> 	<b>B</b> 	<b>C</b> 	<b>D</b> 
Bolt ( 8pcs )	Allen wrench ( 1pc)	Knob(3pcs)	Screw and Sleeve (3pcs)
<b>E</b> 	<b>F</b> 	<b>G</b> 	<b>H</b> 
Washer (8pcs)	Cable tie (1pc)	Short screw (2pcs)	Eyelet screw (1pc)
<b>I</b> 	<b>J</b> 	<b>K</b> 	<b>L</b> 
Mirrored cabinet	Leg(4pcs)	Plastic bracket ( 1pc )	Anchor (1pc)

### Step 1

1.connect the legs (J) to the mirror cabinet,as showing using bolts (A) washers(E) and Allen Wrench (B)

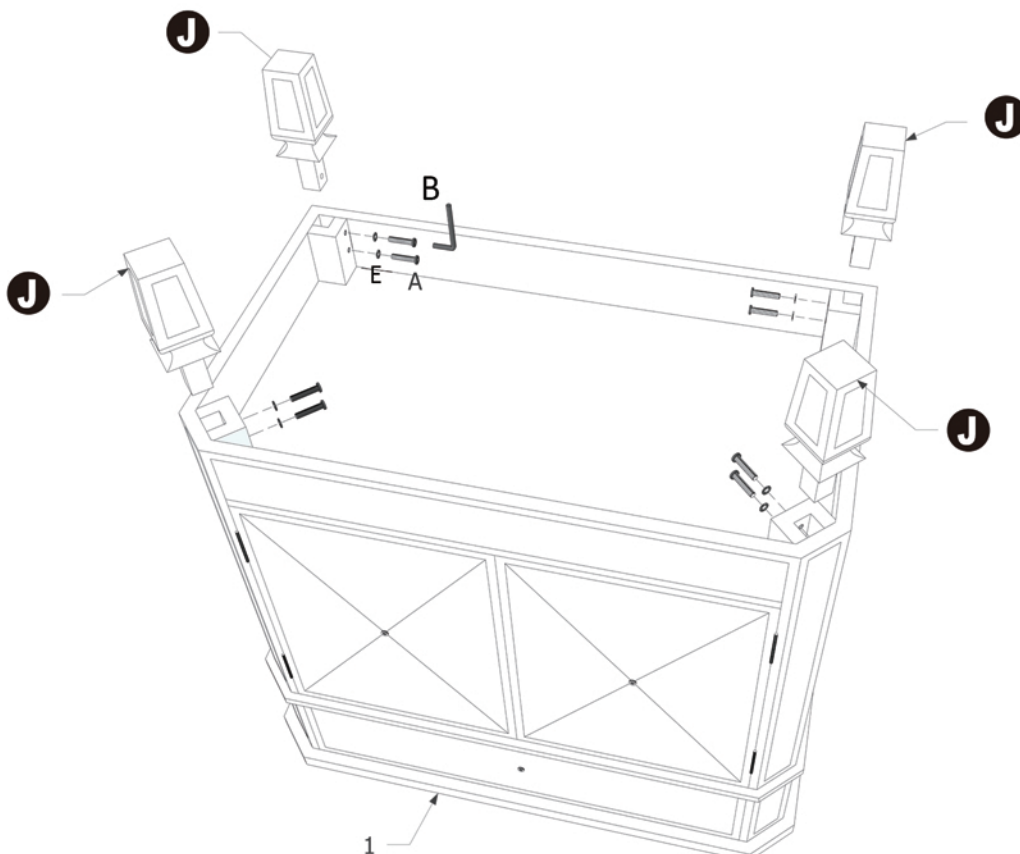

## Step 2

Remove the knob (C) and Sleeve from inside of drawer to outside, using a hand held screwdriver, Screw(D) goes inside of drawer.

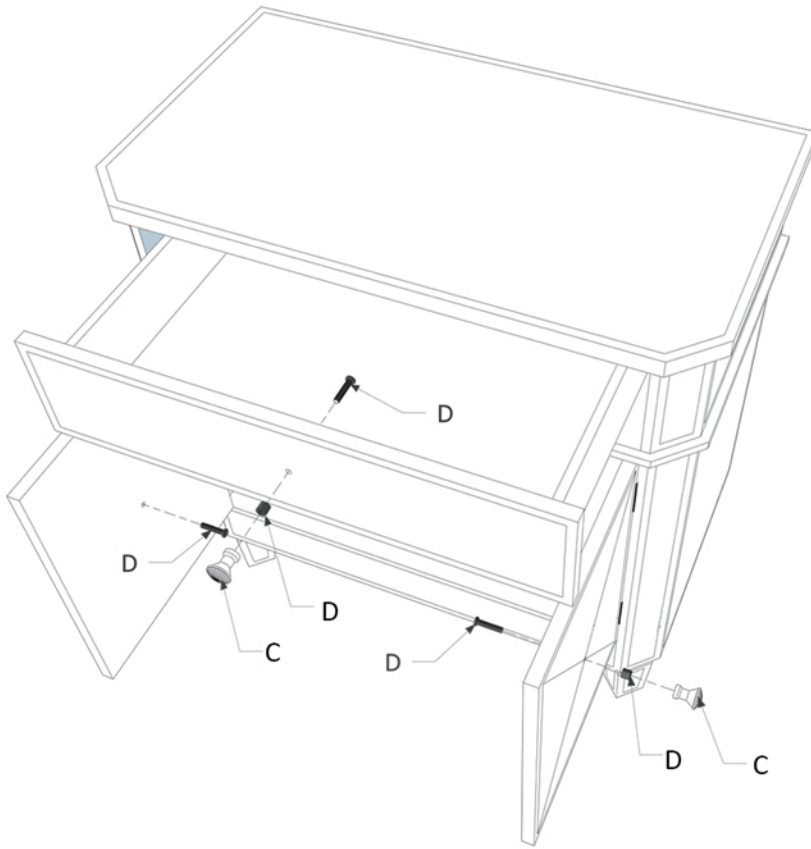

Polishing cloth(1pc)

Attached polishing cloth for your use to clean the mirror

1. Connect plastic bracket(K) to unit as show using short screw (G).
2. Insert cable tie(F) into plastic bracket(K) as show
3. Drill hole slightly smaller than anchor(L) into drywall and gently tap anchor into hole.
4. Insert eyelet screw(H) into anchor and fasten unit to wall using cable tie(F)

