



LED Temporary Work Light

BRIGHTEN YOUR LIFE

NEW LED TECHNOLOGY THAT ALLOWS THE COEXISTENCE OF ENVIRONMENTAL PROTECTION AND ENERGY SAVING

Benefits

1. MH/HPS/HID/MHL/CFL lamp retrofit.
2. Precision Die Cast Aluminum heat sinks.
3. Easy Installation.
4. With plug.
5. CE ROHS ETL listed.



Standard



20W~60W



Optional



Standard
80W~150W



Optional
80W~150W



With Emergency Power



Optional

Microwave Type



Optional

Dimmable Type

Features

1. Beam angle:360 degrees.
2. Aluminum die-casting heat sinks and active air exchanging cooling system in order to speed up heat dissipation.
3. It's major to replace the CFL/MH/HID/HPS.
4. Green, energy saving, long and reliable life of 50,000 hours.
5. No RF interference, No IR/UV radiation ,no mercury pollution.
6. Wide colour availability in degrees Kelvin(K),2700-6700K.
7. Streamline exterior design, beautiful appearance.
8. Environment friendly ,energy saving (70~80%).
9. Special circuit design, each LED work separately, avoiding the single broken LED influence problem.

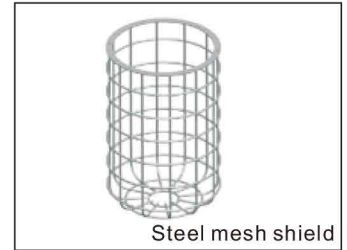

Application

- 1.Sports Lighting/Post Top Lighting.
- 2.Canopy Lighting.
- 3.High/Low Bay Lighting.
- 4.Roadway Lighting/Street Lighting.
- 5.Other applications.

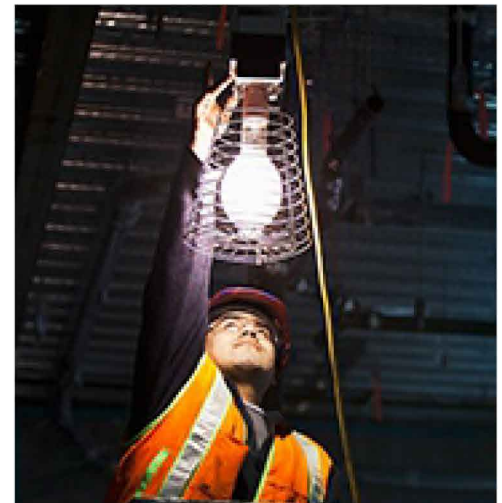
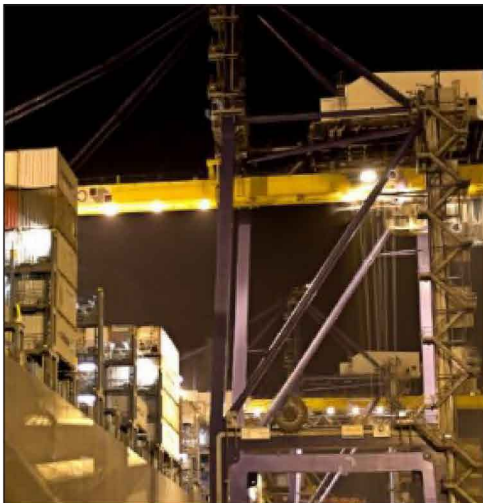

SPECIFICATIONS

Power	20W	30W	40W	50W	60W	80W	100W	120W	150W
Model	BB-HJD-20W-Q	BB-HJD-30W-Q	BB-HJD-40W-Q	BB-HJD-50W-Q	BB-HJD-60W-Q	BB-HJD-80W-Q	BB-HJD-100W-Q	BB-HJD-120W-Q	BB-HJD-150W-Q
Luminous Flux	2600lm	3900lm	5200lm	6500lm	7800lm	10400lm	13000lm	15600lm	19500lm
Replacement	HPS 50W	HPS 100W	HPS 120W	HPS 150W	HPS 200W	HPS 250W	HPS 300W	HPS 350W	HPS 400W
Maximum power in series	120V,50pcs; 220V,75pcs; 277V,100pcs.	120V,33pcs; 220V,50pcs; 277V,66pcs.	120V,25pcs; 220V,37pcs; 277V,50pcs.	120V,20pcs; 220V,30pcs; 277V,40pcs.	120V,16pcs; 220V,25pcs; 277V,33pcs.	120V,12pcs; 220V,18pcs; 277V,25pcs.	120V,10pcs; 220V,15pcs; 277V,20pcs.	120V,8pcs; 220V,12pcs; 277V,16pcs.	120V,6pcs; 220V,10pcs; 277V,13pcs.
Maximum power in series	120V,Max 1000W; 220V,Max 1500W; 277V,Max 2000W.								
Light Source	SMD LED								
Luminous Efficacy	≥130lm/w								
Options	1.For 20~60W lamp,it has a built-in socket for easy series connection. For 20~60W/80~150W lamp,the connector is optional. 2.With emergency power(After the power failure, make sure the lamp can still work for 1.5h).								
Operation Temp.	-40 to +45°C								
CCT	2700K SW / 3000K WW / 4100K NW / 5000K DW / 5700K CW / 6500K SCW								
CRI	80+								
Life Span	50,000 hours at 25°C								
Voltage	100-277VAC/50-60Hz			200-480VAC/50-60Hz available					
Driver	Internal Power Supply								
Dimming	Standard: Not dimmable ; Dimmable optional.								
Sensor	Standard: No sensor ; Microwave sensor optional.								
Remote Control	Standard: No remote ; Remote control optional.								
Beam Angle	360°								
Cover	Transparent cover(default)								
PF	>0.95								
Warranty	5Years								

DIMENSIONAL DRAWING

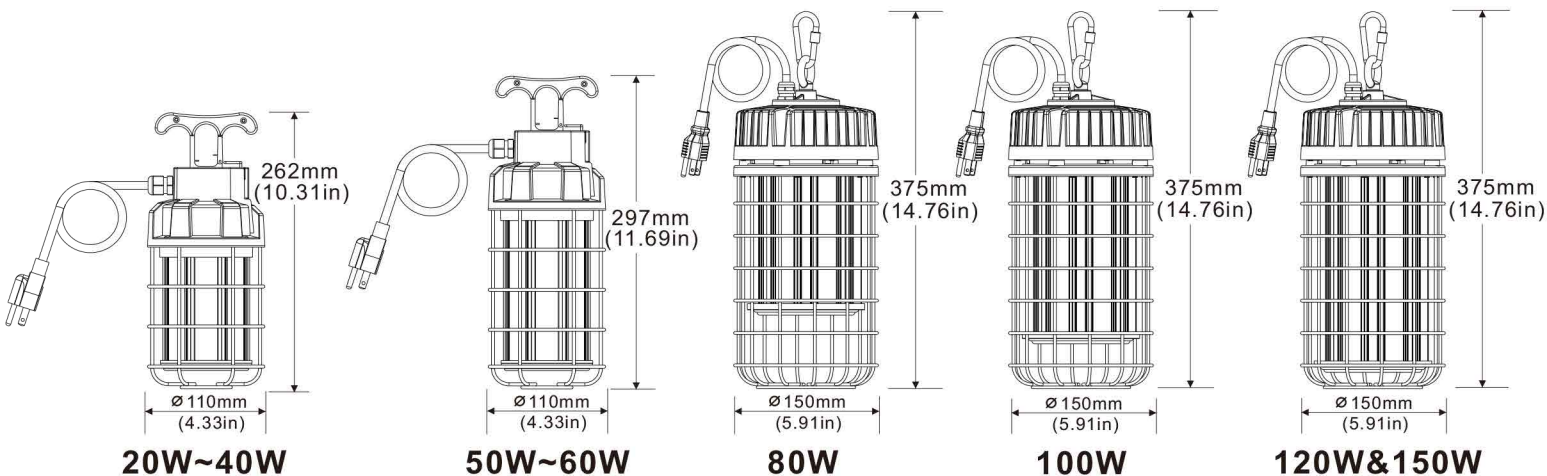

LUMINOUS INTENSITY DISTRIBUTION

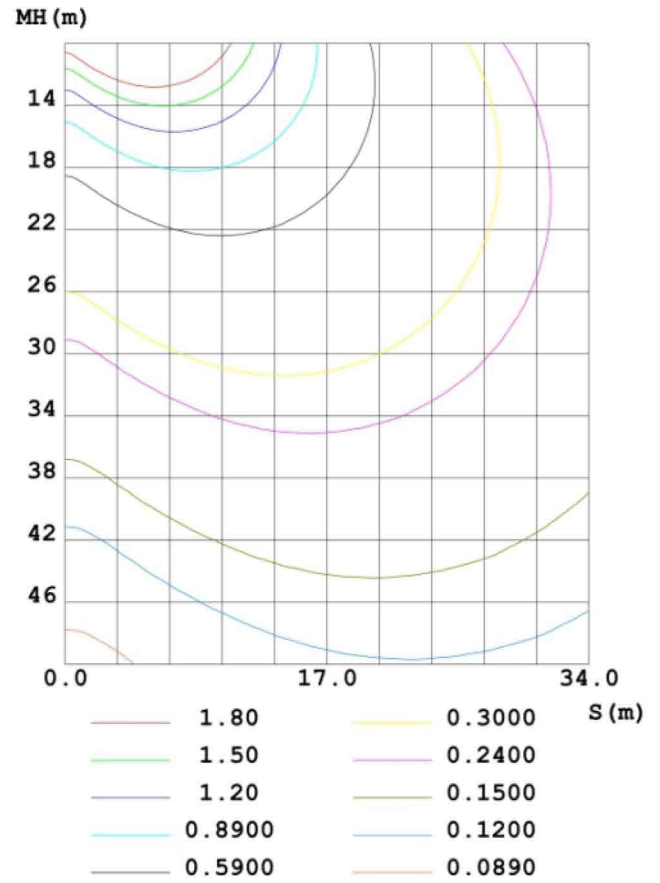
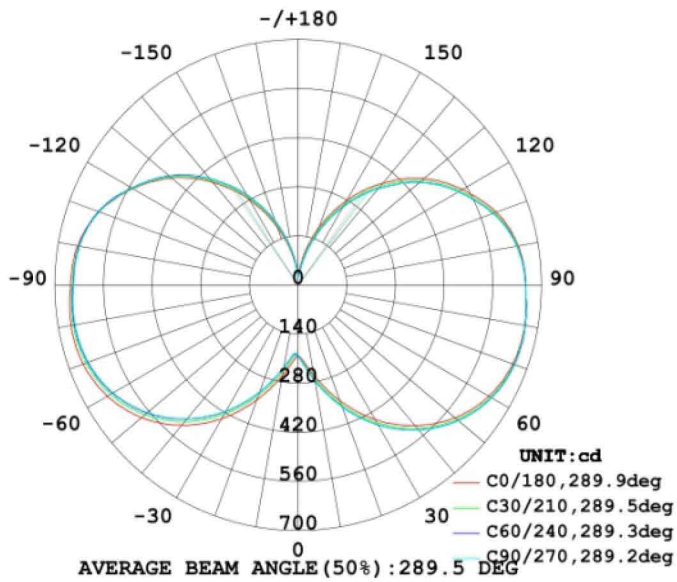

PROJECTS

By using our 100W LED Work Lamp to replace 300W Metal Halide bulb for Temporary Work lighting fixtures, the customer is now able to save a lot per month from his electric bill.



Replace



100W LED = 300W MH

Note:

- Don't take the LED lamp apart.
- The LED lamp must work under the right voltage according to the specification.
- Must remove the Ballast, Capacitor, Ignitor before installing our LED Light.

Emergency Module

Emergency module is not provided. If you need it, please contact sales.



Emergency Light Push To Test:

1. In the state of mains power, press the test switch once, and emergency for 30 seconds.
2. In the state of mains power, press the test switch twice within 2 seconds, and emergency wait until the battery is completely discharged.
3. In the emergency state, pressing the test switch will turn off the emergency state, and the lamps and emergency indicators will go out at the same time.

Charging Indicator Light:

1. In the state of mains power, the indicator light is always on.
2. In the emergency state, the indicator light flashes slowly (on for 2 seconds and off for 2 seconds).
3. In the fault state, the indicator flashes quickly (on for 0.2 seconds, off for 0.2 off).

Control Board Box

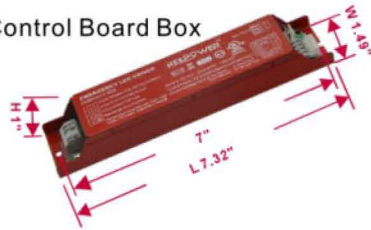

Battery Pack



Feature

- ★ UL listed for us and Canada.
- ★ Listed to UL924 and tested to CSA C22.2 No.141 Field or factory installation.
- ★ High voltage output
- ★ Low energy consumption CEC compliance.
- ★ Constant output power.
- ★ Self-testing.
- ★ Battery: over temperature protection.

Wiring

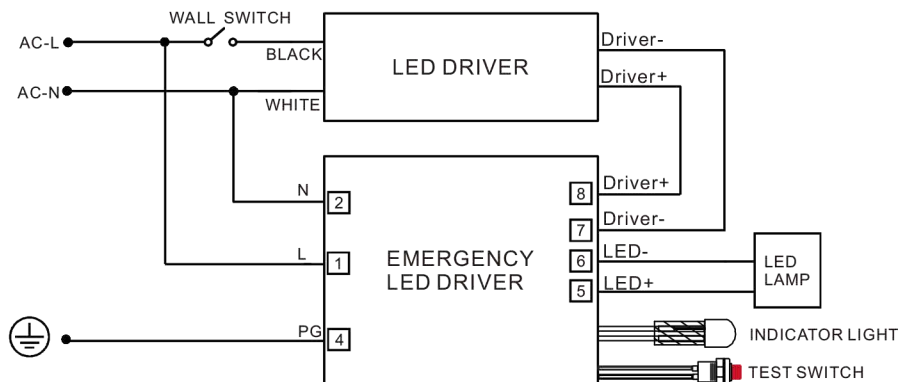

WIRING DIAGRAM 1 (The lamp power is less than 120W and the driver's output current is less than 3A.)

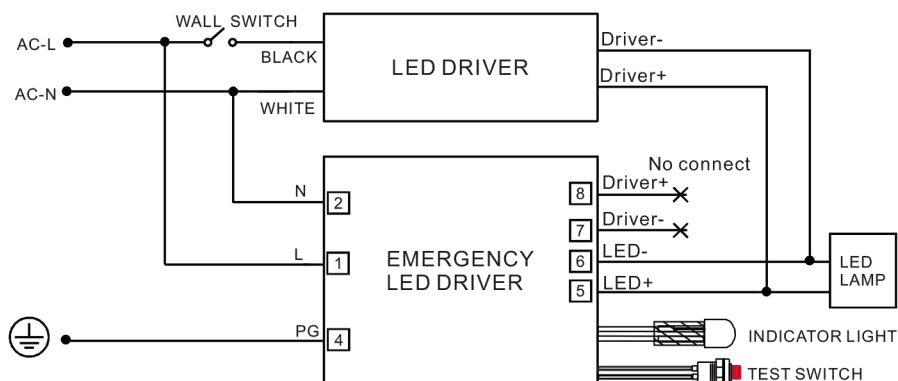

WIRING DIAGRAM 2 (The lamp power is more than 120W and turn off wall switch before testing.)

MICROWAVE MOTION SENSOR

*The microwave motion sensor is not provided by default, If you need, please contact sales.



Microwave motion sensor



On/off control



Detection area



Hold time



Daylight sensor



Stand-by period



Stand-by dimming level



Remote control setting

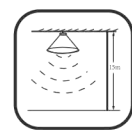

10-15M Highbay altitude



5 year warranty

Technical data

Operating voltage	10-15V DC
Operating current	30mA±5%
Output	DIM 1-10V
Stand-by power	<0.5W
Detection area	25%/50%/75%/100%
Hold time	5s/30s/1min/3min//5min/10min/20min/30min
Daylight threshold	2Lux/10Lux/50Lux/Disable
Stand-by period	0s/10s/30s/1min/5min/10min/30min/+∞
Stand-by dimming level	10%/20%/30%/50%
Microwave frequency	5.8GHz±75MHz
Microwave power	<0.3mW
Detection angle	30-150°
Control line	Red 12V; Black GND; White -; Yellow +
Mounting height	Max.15m(ceiling mounted)
Detection range	Max.∅14m(ceiling mounted) Max.20m(wall mounted)
Operating temperature	-20°C~ +60°C
IP rating	IP20

Detection coverage

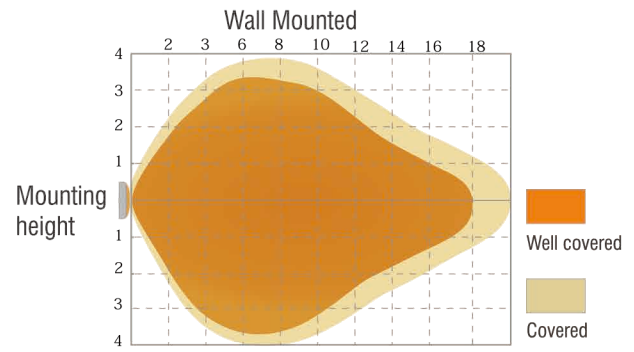
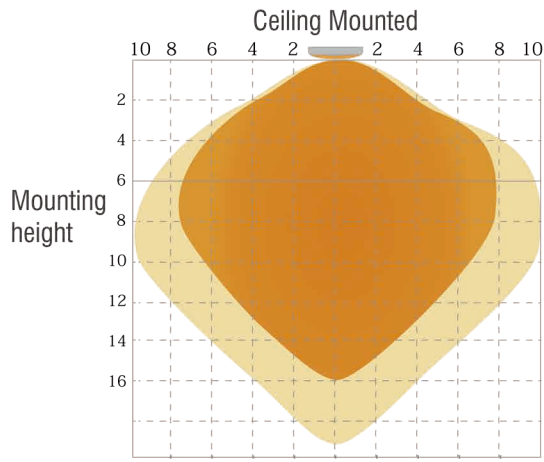

Lux on/off

Adopted dual PD technology, the sensor is able to differentiate artificial light brightness from natural light after installed inside the fixture, and automatically turn off light when ambient brightness exceeds preset lux level.

Preconditions to use the Lux-off function:

1. Standby period is $+\infty$;
2. Standby dimming level is on 10%, 20% or 30%;
3. Daylight threshold is on 30Lux, 50Lux, 80Lux or 120Lux.

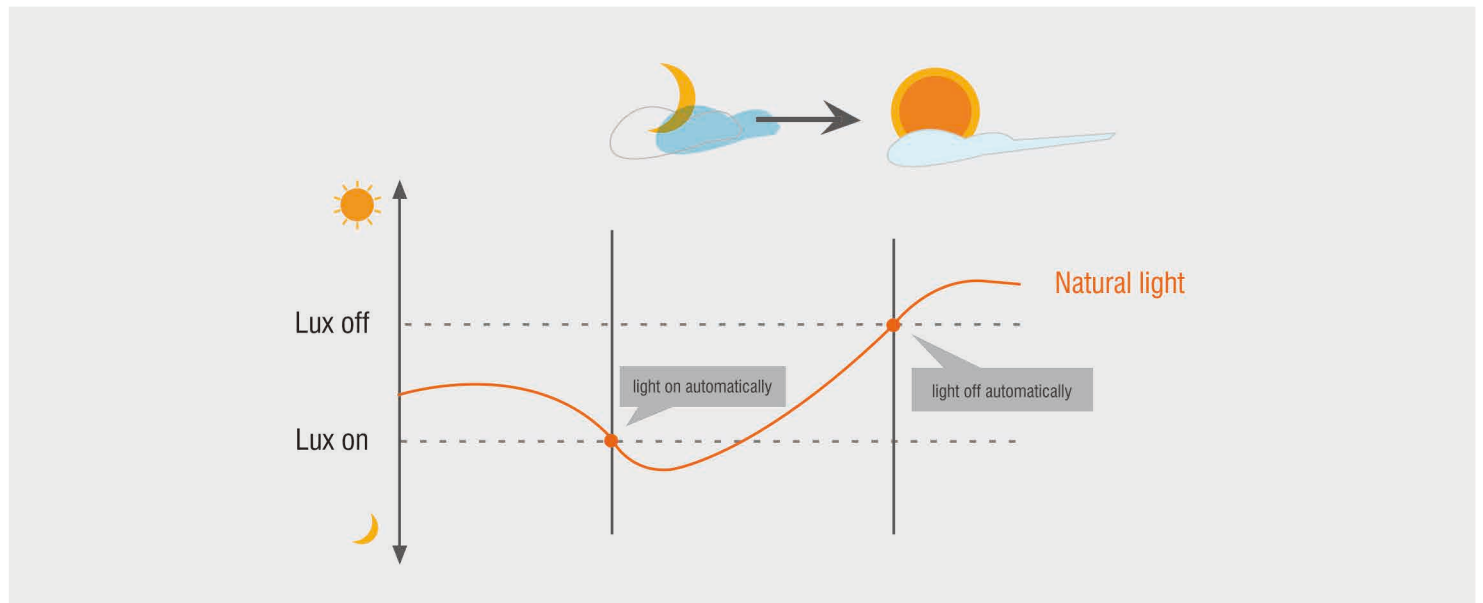

Application---Lux on/off

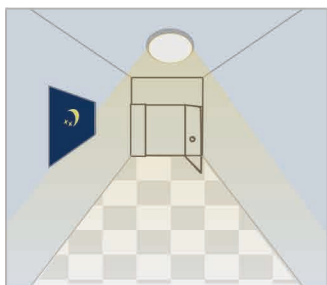

Light automatically on when ambient brightness is lower than preset lux level.



With insufficient ambient brightness, light dims to 100% when motion detected

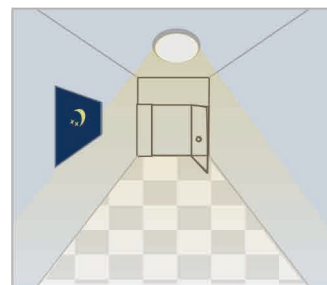

Light dims to standby level if no motion detected after holdtime

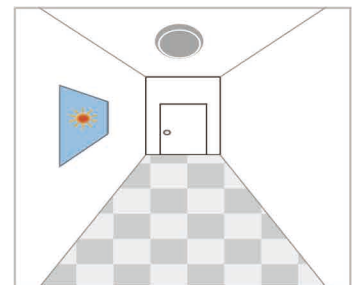

Light off when ambient lux level is higher than preset lux amount.

Remote Control

*The remote control is not provided by default, If you need, please contact sales.



RC01

Remote control for microwave type

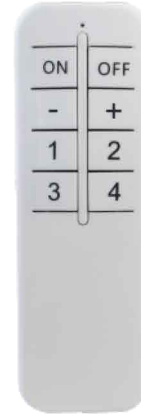

RC02

Remote control for dimmable type

Remote control RC01



● **ON/OFF**

* Press the "ON/OFF" button, the light keeps permanently on or off.
* Press "Auto Mode", "RESET" or "Scene mode" buttons to quit from this mode.

● **Auto Mode**

* Press "Auto Mode" button, the sensor starts to work and all settings remain the same before the light gets switched on/off.

● **Reset**





* Press "RESET" button, products with DIP switch will be controlled by DIP switches.



● **Scene Mode**

Scene Mode	Detection	Hold-time	Daylight threshold	Stand-by period	Stand-by dimming level
Sc1	100%	30s	2Lux	1min	10%
Sc2	100%	5min	10Lux	10min	10%
Sc3	100%	10min	50Lux	30min	10%
Sc4	100%	30min	Disable	+∞	10%

● **Test**

* The button "Test (2s)" is for testing purpose after commissioning. Pressing this button, the sensor goes to test mode (hold time is only 2s) automatically, stand-by period and daylight sensor are disabled.
This mode can be ended by pressing "reset", "Auto mode", "scene mode" or "hold time".
The sensor setting is changed accordingly.
Brightness settings: Disable.
Test mode can press any key to exit this mode.

 On/off control	There are 4 fixed scene modes program built-in the remote control to choose for different applications.
 Detection area	Press the button "detection range" to set detection range as 100% / 75% / 50% / 10%.
 Hold-time	Press the button "hold-time" to set hold-time as 5s / 30s / 1min / 3min / 5min / 10min / 20min / 30min .
 Daylight threshold	Press the button "daylight sensor" to set daylight threshold as 2Lux / 10Lux / 30Lux / 50Lux / 80Lux / 120Lux / disable.

 Stand-by period	Press the button "stand-by period" to set stand-by period as 0s / 10s / 30s / 1min / 5min / 10min / 30min / +∞. Note: "0s" means on/off control; "+∞" means bi-level dimming control.
 Stand-by dimming level	Press the button "stand-by dimming level" to set the stand-by dimming level as 10% / 20% / 30% / 50%.

Sensor installation method:

- * The distance between the inductor and the sensor is 4m wide;
- * Recommended installation of sensor suction ceiling height 3-6m;
- * Wall mounting height suggested 1-1.8m;
- * The remote controls the most remote distance 15 meters (in different places remote control distance will have the deviation).
- * Weight (including battery): 56.5g.

Remote control RC02

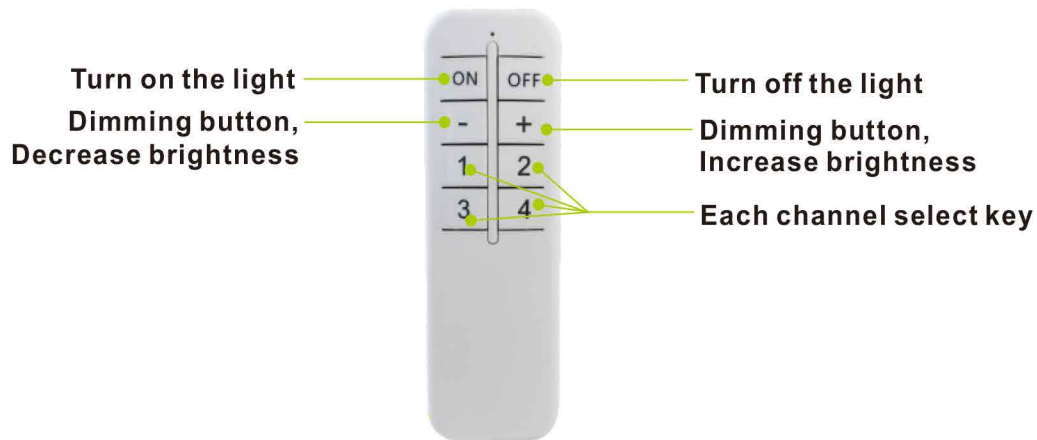

Function:

- * **Wireless remote control, you can remotely control the light switch.**
- * **Can control the lights of 4 groups of channels, each group is independent. Multiple lights can be set for each group.**
- * **The remote control distance is 10-20m.**
- * **Dimming function, you can increase and decrease the brightness of the lamp.**
- * **Must be used with dimming driver.**

Note:

- * The work light without sensor and the work light with sensor can be equipped with RC02 remote control.
- * Only work light with sensor can be equipped with RC01 remote control.

Tripod Stand

Tripod stand is optional(Adjustable height 0.6m~1.6m).

Customers can choose according to their needs.If necessary, please contact sales.

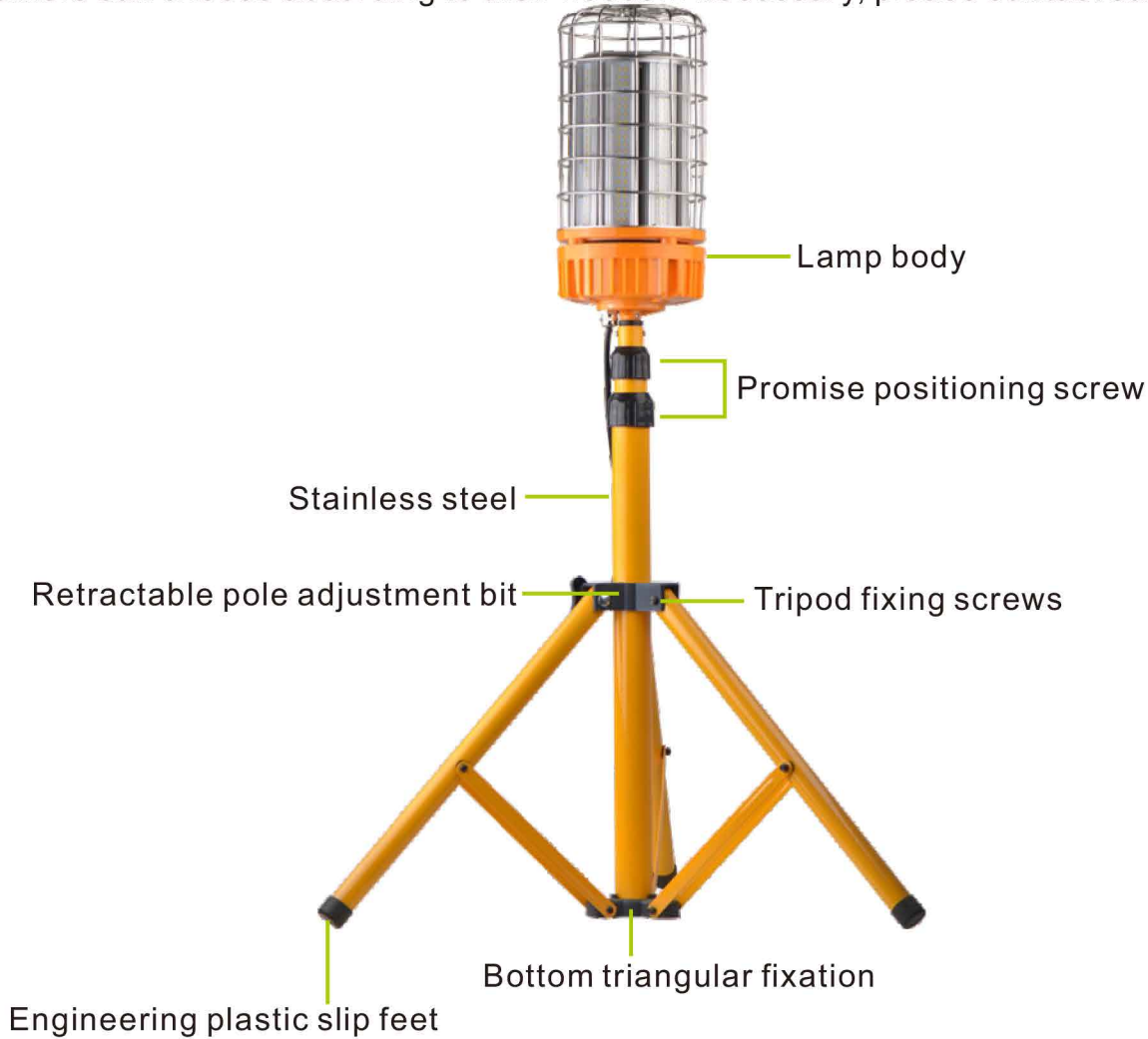

With Connector

1.For 20~60W lamp,it has a built-in socket for easy series connection.



2.For 20~60W / 80~150W lamp,the connector is optional. Customers can choose according to their needs. If necessary, please contact sales.

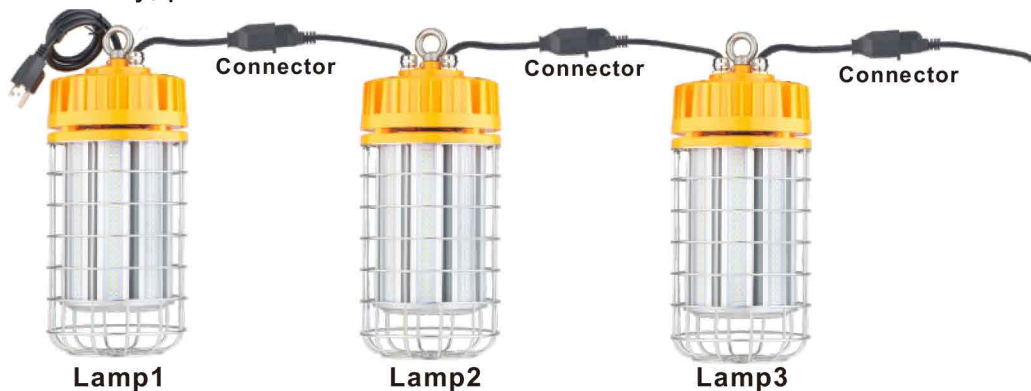

INSTALLATION

Normally. The traditional lamp has the ballast or capacitor or ignitor, like HPS, MH.

Replace E40/E27 CFL

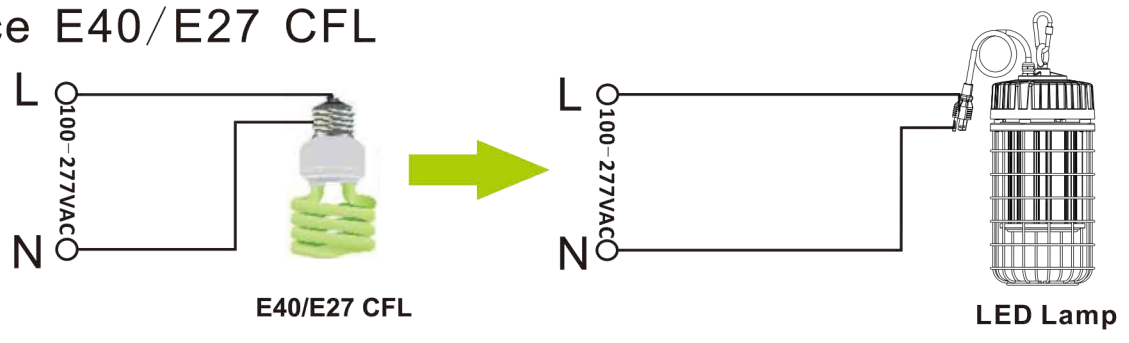

Replace HPS/MH

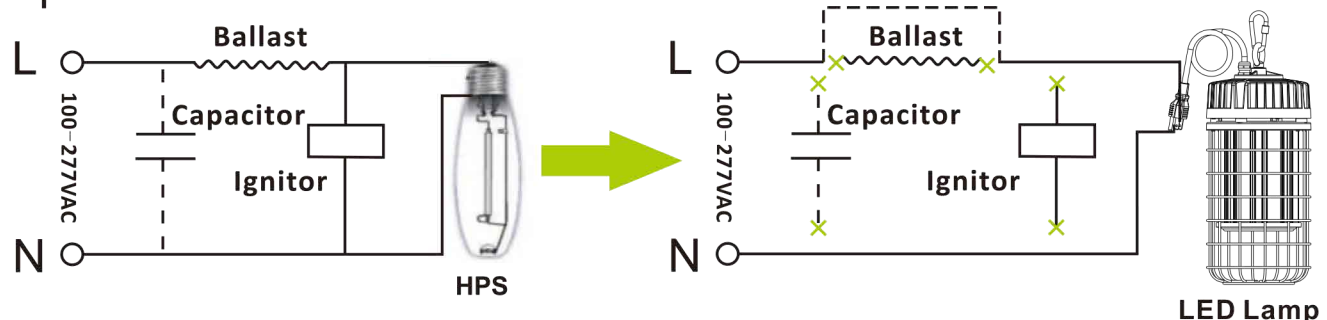

1. Remove the Ballast, Capacitor, Ignitor
2. Only need to put the L (live wire), N (null line) connected to the external power supply

PACKING INFO

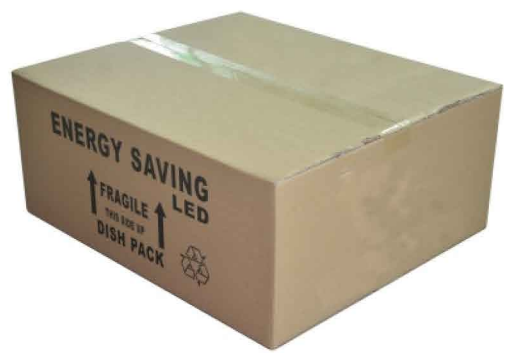

Items	Packaging	Carton Size(mm) (L*W*H)	N.W	G.W	Volume weight
20W~40W	12pcs/CTN	600*490*340mm	9.0kg	10.5kg	22.0kg
50W~60W	12pcs/CTN	740*490*340mm	12.0kg	13.5kg	28.0kg
80W	6pcs/CTN	610*430*420mm	13.4kg	14.5kg	22.0kg
100W	6pcs/CTN	610*430*420mm	14.2kg	15.3kg	22.0kg
120W&150W	6pcs/CTN	610*430*420mm	15.8kg	16.9kg	22.0kg
Tripod Stand	1pcs/CTN	620*100*100mm	2.6kg	3.5kg	2.5kg
	12pcs/CTN	640*330*420mm	42.0kg	43.0kg	22.0kg