

70W LED Glass Wall Pack



Features

- Lumileds LED, high luminous efficiency and long working life.
- High efficiency LED Driver, the wide range input voltage AC120-277V.
- Die Cast aluminium cooling design, high quality and better cooling for LED $T_j < 85^{\circ}\text{C}$.
- Excellent Optics design, greatly improve the light utilization and evenness.

Product Applications

WSD LED Glass Wall Pack series can be widely used in indoor or outdoor lighting (Wet location), like mechanical or electronic processing workshops, storage warehouses, steel mills, gas stations, toll booth, waiting rooms, the platforms of railway station, indoor stadiums.



Specifications

Unit : inch(mm)

Structure Features

- Shell materials: Aluminum & Glass.
- Finish: Dark Bronze/White
- Net weight : 4.7Kg (10.4 lbs)
- Product Size: 390mm*252mm*243mm
- Carton Size: 450mm*315mm*310mm

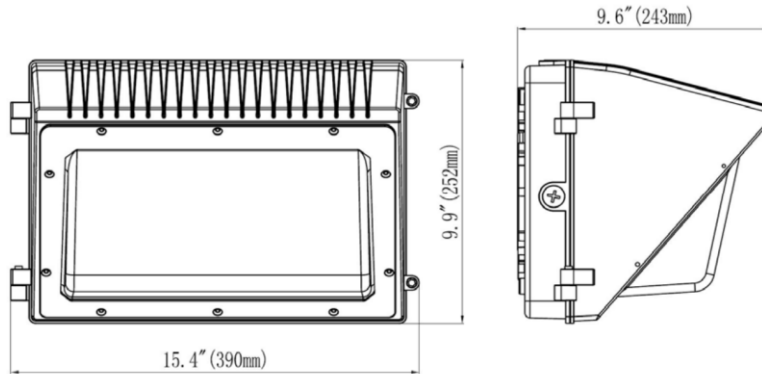

Technical Parameters

WSD-GWP07W27-XXK-Z[D,W,B]-P[Blank,P]

Power	70W	Lighting Angle	87°x118°
Input Voltage	AC120-277V	LED Brightness Decay	<5%/6000 hrs
PF	>0.95	Working Life	>50000 hrs
Driver Efficiency	>90%	Working Temperature	-30 - +45°C
Luminous Flux	9100 Lm	Storage Temperature	-40 - +80°C
Color Temperature	4000K/5000K	Protection Level	Wet Location/IP65
CRI	Ra>70	Cable	Input Connect, No cable

Photometry

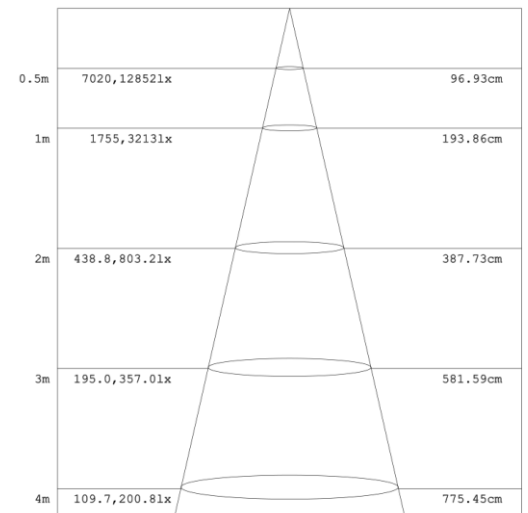
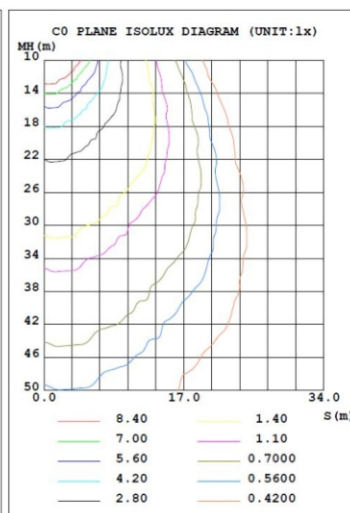
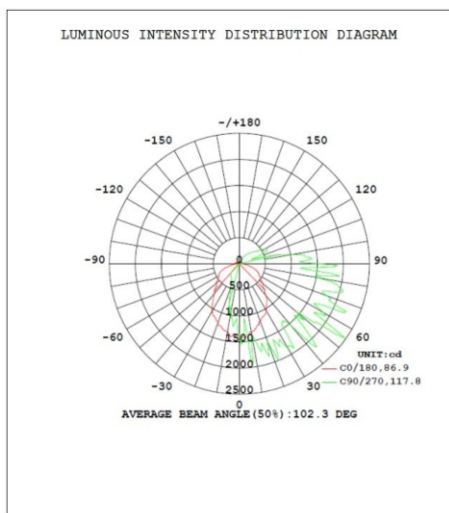

Example: WSD-GWP07W27-XXK-Z[D,W,B]-P[Blank,P]

WSD	GWP	07W	27	XXK	Z	P
Company	Product	Power	Voltage	Color Temp	Finish	Control
	GWP	07W(70W)	27	40K(4000K)	D (Dark Bronze)	P
WSD LED INC	Glass Wall Pack		AC120-277V	50K(5000K)±500K	W (White) B (Black)	Photocell