



155  
lm/w

IP66

LOW UGR

SMART  
CONTROL

## Refinado LED Modular Linear High Bay LHB09

100W/150W/200W/240W/300W/400W/480W

Huge light-emitting area,  
Modular design, Sturdy structure



100W/150W

200W/240W/300W

400W/480W

## Special Fresnel Lens Multiple Light Distribution

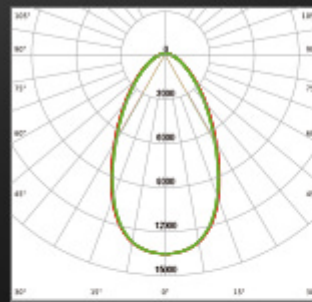
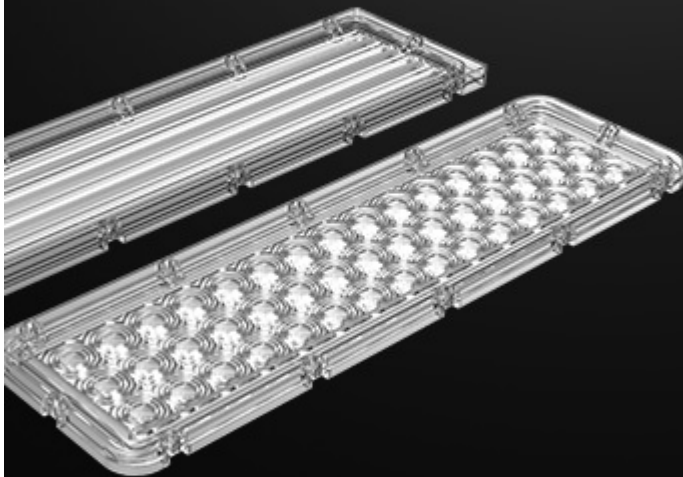

L04501

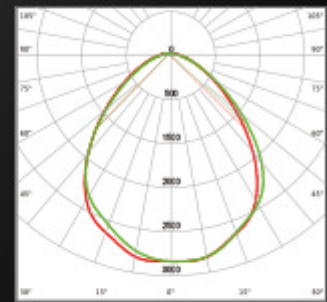

L04502

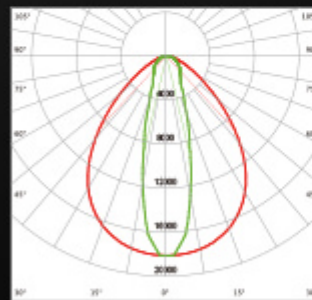

L00401

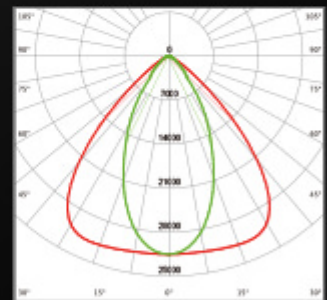

L00402

Separate space for integral PIR sensor, microwave motion sensor, Zigbee, DALI, emergency backup and reserved hole for intelligent solutions.

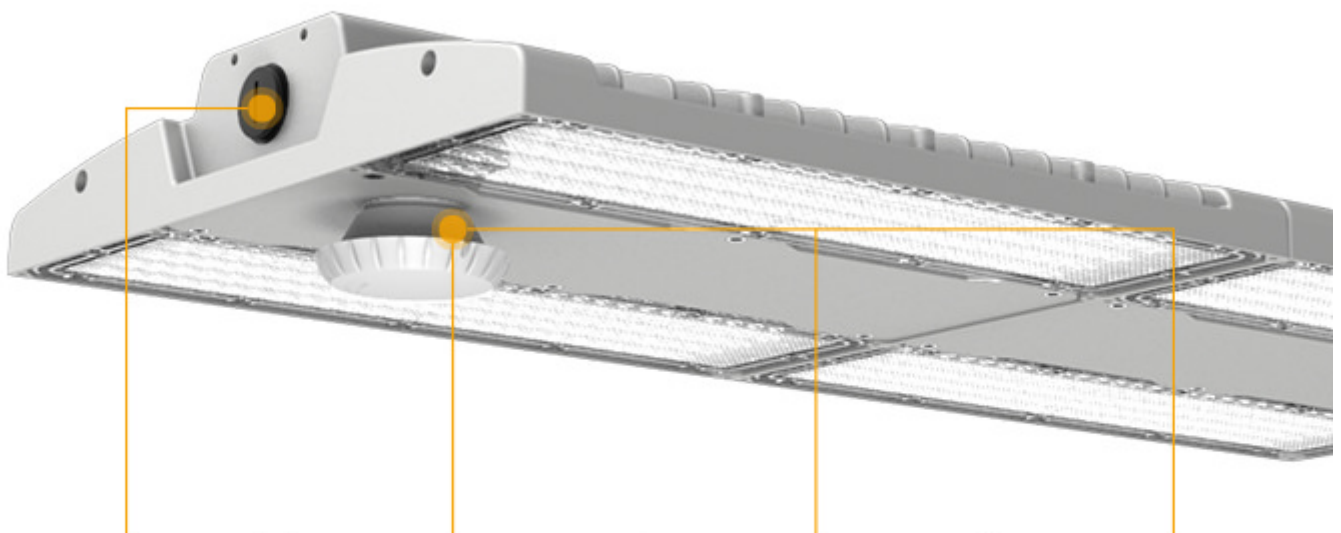

Reserved hole for DIY

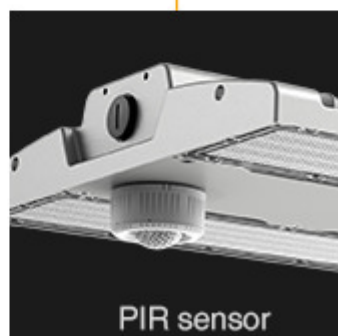

PIR sensor



Motion sensor



Emergency backup



## Fully customizable solution



Higher luminous efficacy:  
Higher lumen output  
available on request

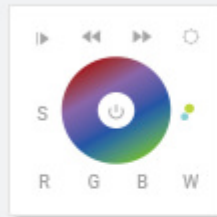

Dimmer switch: Allow you  
to heighten or lower the  
watts and lighting levels

## Double color temperature:

Two kinds of CCT can be changeable by a switch

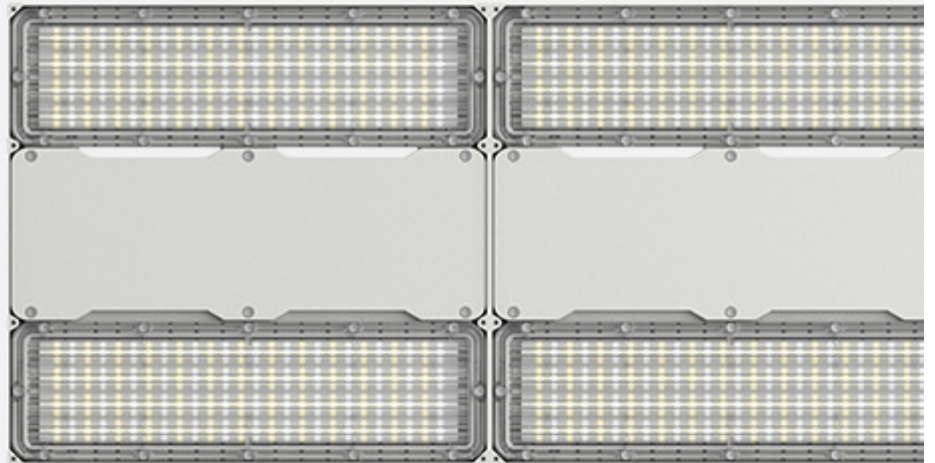
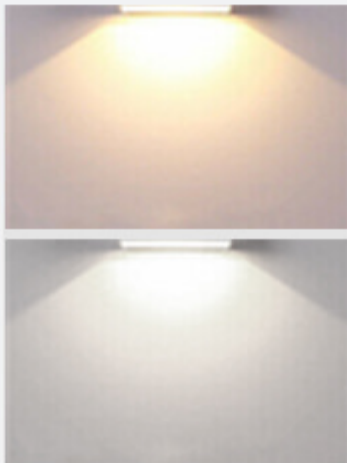

## Mounting Options:

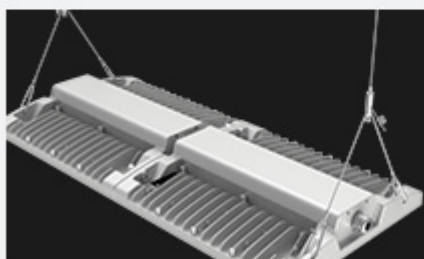

Suspension mount

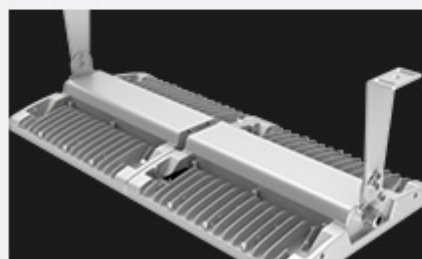

±60°rotatable ceiling mount



Non-adjustable ceiling mount

