

Marvo™

LED Flood & Area Light

Multi-Wattage Switchable

E-LITE semicon





EXTRAORDINARY SKU REDUCTION

Featuring substantial SKU reduction with universal mounting and power adjustability, the innovative MARVO™ offers the best value in the commercial & industrial floodlight market.

PRODUCT FEATURES & BENEFITS

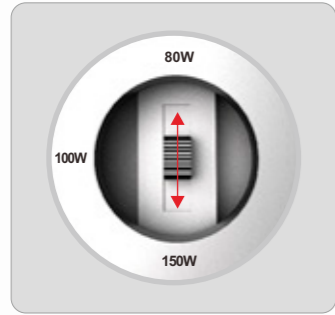

Multi-Wattage Switchable
80W-100W-150W



Slim & Sturdy One-piece
Die Cast Aluminum Housing

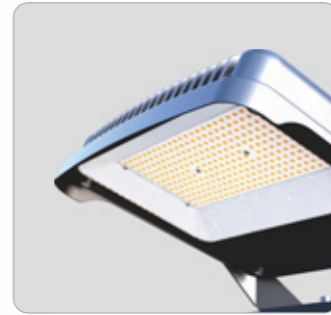

Integrated Visor Reduces
Observable Glare

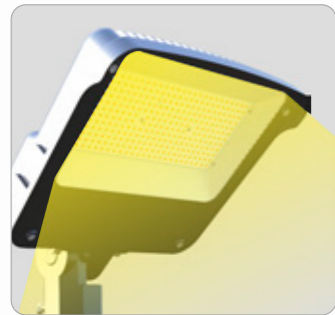

High Efficacy Up to 150LPW



High-reflectance white reflector
maximizes output

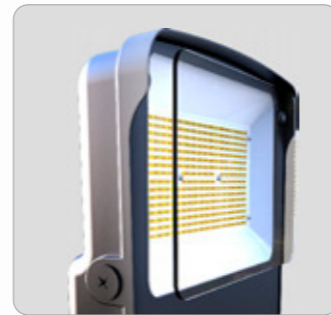

Tempered glass lens won't yellow



Photocell



EMERGENCY POWER PACK (OPTIONAL)

Emergency power pack installed in the light fixture as an option to provide ≥ 90 mins emergency lighting, which is switched on automatically in case of external power cut off.

For North America Market

Rated Voltage	AC 100-277V	Emergency Time	≥ 90 MIN	Switch-over Time	≤ 1 S
Main Power Consumption	5W	IP Rating	IP65	Battery Specification	LI-ION/3.6V/2600mAH
Charging Time	≤ 24 H	Operating Temperature	0°C-55°C	Control	Individual Control

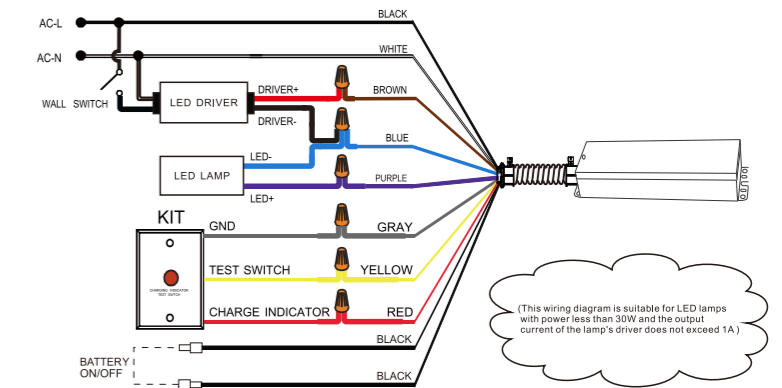
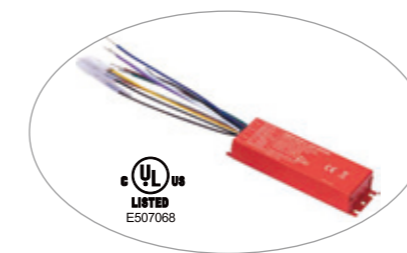

For EU & Other Market

Rated Voltage	AC 100-277V	Emergency Time	≥ 90 MIN	Switch-over Time	≤ 1 S
Main Power Consumption	≤ 15 W	IP Rating	IP65/IP30	Battery Specification	NI-cd/12V/1500mAh
Charging Time	≤ 24 H	Operating Temperature	-10°C-55°C	Control	Individual Control

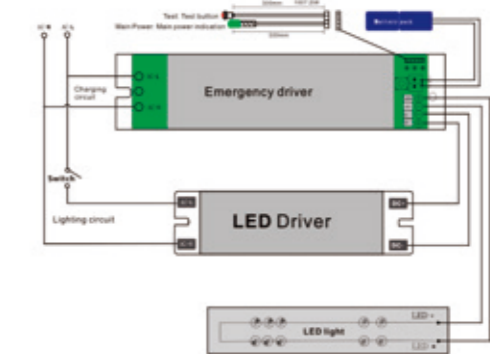

PERFORMANCE

LEDs	Philips Lumileds
CCT	4500~5500K (Standard) 2500~6500K (Optional)
CRI	≥70
L70	L70>120,000 Hours
Voltage	100-277 VAC
PF	0.95 min
IP	IP66
IK	IK08
Coating	Corrosive Resistant Polyester Powder
Material	Tempered Glass
Temperature	Operating Temperature:-45°C to +45°C (-49°F to 113°F) Storing Temperature:-45°C to +80°C (-49°F to 176°F)
Humidity	15% to 95% RH





SPECIFICATIONS

Part#	Power	Efficacy(IES)	Total Lumen	N.W	Product Dimensions
EL-MVFL-MW (80/100/150)T	150W	140LPW	21,000lm	3.5kg / 7.7lbs	338.5×323×80mm 13.3×12.7×3.15in
	100W	148LPW	14,800lm		
	80W	150LPW	12,000lm		
EL-MVFL-MW (150/180/200)T	200W	140LPW	28,000lm	3.5kg / 7.7lbs	338.5×323×80mm 13.3×12.7×3.15in
	180W	145LPW	26,100lm		
	150W	150LPW	22,500lm		



PHOTOMETRICS

120° (Without Additional Louver)

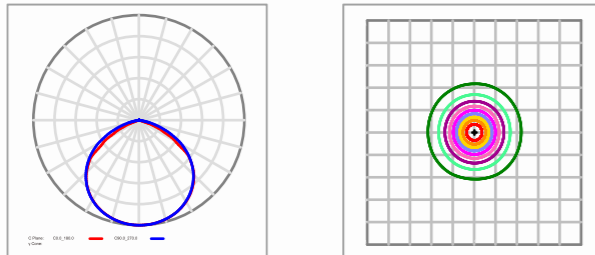

100x120° (With Additional Louver)

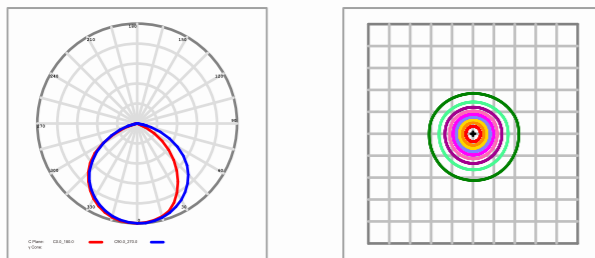



INSTALLATION

For high performance and long term reliability, the light should be installed in free air.

Universal Hanging Bracket

1. Rotate the bracket to the desired angle and tighten screw to lock it.
2. Bolt the universal mounting bracket to the field mounting point. Bolt the center point before the two side points. Tighten the bolts to wrench tight.
3. Wiring. (Connect supply wires to luminaire wire leads per the wiring diagram using methods that comply with all applicable codes.)

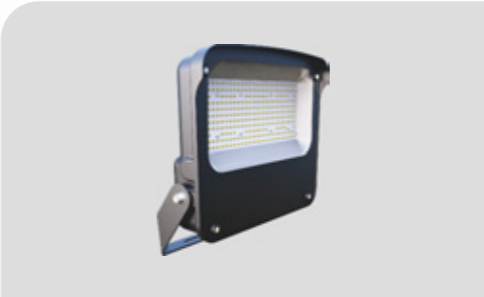

U Bracket Mount



Trunion



Slip Fitter



Knuckle

ORDERING INFORMATION

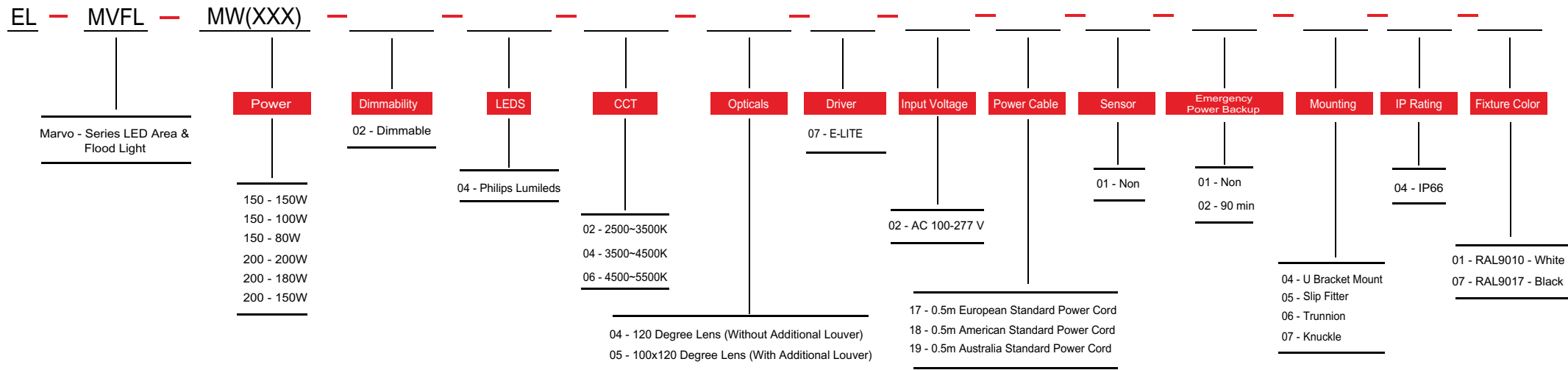

E-Lite Semiconductor Co., Ltd.
 Headquarter & Factory
 Website: <http://www.elitesemicon.com>