



# HK Hunter Indoor Team Building Games

2023

# Indoor Team Building Games

 HK\$8,000 +

 2 – 3 hours

 10 – 100+

## Description

Depending on your team-building objectives and time, you can choose up to four indoor team-building games for your indoor event. You may also put indoor/virtual scavenger hunt, room escape boardgame and trivia quiz in our indoor game packages.

## Game Idea

- |                            |                                  |                         |
|----------------------------|----------------------------------|-------------------------|
| 1. Marshmallow Challenge   | 6. 100 Different Ways of Walking | 11. The Ball Game       |
| 2. Sneak a Peak            | 7. Room Escape Boardgame         | 12. Build the Tower     |
| 3. Auction & Building Game | 8. Perfect Square                | 13. Blocked Perspective |
| 4. Pop the Bloons          | 9. Zoom and ReZoom               | 14. Murder Mystery      |
| 5. Scrabble Hunt           | 10. Helium Stick                 | 15. Trivia Quiz         |

## Objective

The main objectives of these team building games are to build trust, enhance communications & facilitate team spirit among team members. Some games also aim to inspire creativity, encourage participants to think out of the box while others enhance problem solving, time management and resources allocation.

# Indoor Game

## Marshmallow Challenge

 30 – 40 mins

 10+

In 18 minutes, you need to build the tallest free-standing structure out of 20 sticks of spaghetti, 3 feet of tape, 3 feet of string, and one marshmallow. The marshmallow must be on top.

### Rules:

1. Teams cannot hold to the structure when the time runs out
2. Teams are free to break the spaghetti, cut up the tape or string into different forms
3. The tower cannot lean on anything
4. The marshmallow must be on top

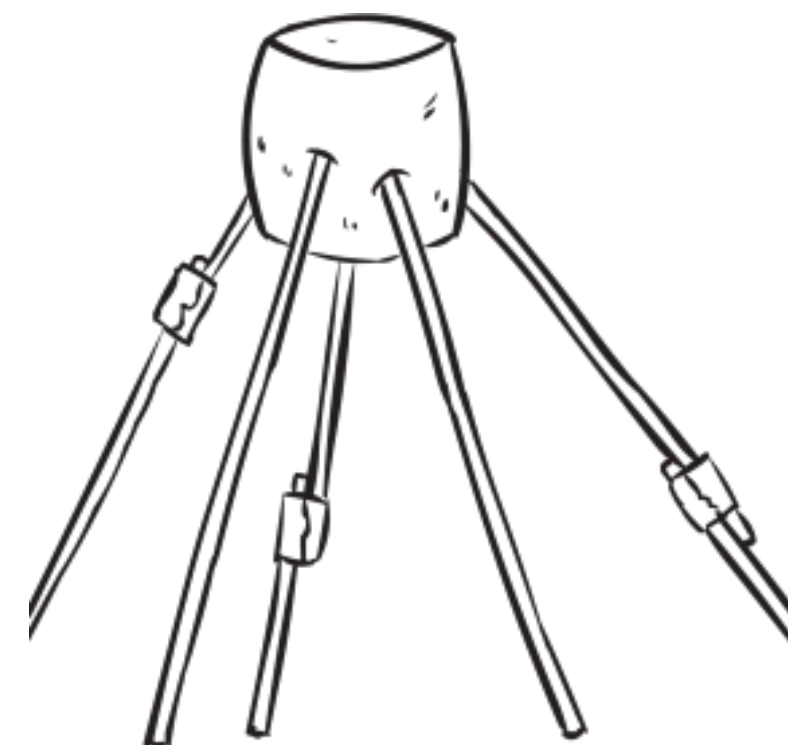

# Indoor Game

## Sneak a Peak

 20 – 30 mins

 10 – 100

There is a small sculpture with some of the building blocks your team need to replicate. The sculpture will be put in a place which is far from your team. Each time one member of your team can come up to look at the sculpture for 10 seconds and try to memorize it before returning to your team.

Rules:

1. Only one member is allowed to look at the sculpture each time
2. Each member will take turn to look at the sculpture
3. Recreate the sculpture within 10 turns.

Number of turns will also be counted for extra bonus.



# Indoor Game

## Auction and Building

 60 – 90 mins

 10+

Each team needs to take part in an auction to buy materials in order to build a structure within an hour. In the end, they need to present and sell their structure in front of the audience. However, there will be unexpected incident or policy changes so they may need to compromise and think out of the box. The team who use less resources and create the best structure will be the winner.

### Rules:

1. Each team will be given some basic materials
2. Each team can use their chips to bid or buy premium resources
3. Teams can trade their materials under mutual agreement
4. The final structure or product needs to fulfill the building requirements



# Indoor Game

## Pop The Bloons

 35 – 45 mins

 10+

Every team will be given a certain number of balloons, together with some accessories. They need to pump and deliver the balloons to the customer.

The customer, however, only accepts a certain standard of balloons delivered that the teams don't know. When the customer is not happy with the balloons delivered, he/she will reject your deliver and request the team to deliver again!

The team deliver the most balloons wins the game.



# Indoor Game

## Scrabble Hunt

 30 – 40 mins

 10+

Every team will be given some scrabble tiles at the start of the game. Extra tiles can be found in the indoor area or upon finishing some missions.

Try to collect as many tiles as possible, trade and exchange with other teams to form as many words as possible.



# Indoor Game

## 100 Different Ways of Walking

 30 – 40 mins

 30+

Every participant takes turn to go for a CAT-WALK on stage, but each person needs to be unique and different from others. This activities emphasize on innovation, learning from others and change of mindset.

(Better for large group of people)





# Indoor Game Room Escape Boardgame

 60 – 75 mins

 10 – 50

In this challenging and unpredictable game, you have to work together to solve puzzles and find hidden clues. It's always a race against the clock; you only have 60 minutes to escape in each game.

## Rules:

- Your team will have 60 minutes to escape the room
- You will get hints at particular time intervals
- You may use images, gears, words, keys, shapes, maps to solve the riddles
- Enter the password to the time machine, for each wrong guess 1 minutes will be deducted from the total time



# Indoor Game

## Perfect Square

 20 – 30 mins

 10 – 50

This is a physical exercise with an aim to encourage teamwork and collective problem solving. It also highlights the importance of self-organisation and the necessity for leadership when confronted with challenging tasks.

While blindfolded, they must make this rope into a square. They must all be holding part of the rope to qualify for success.

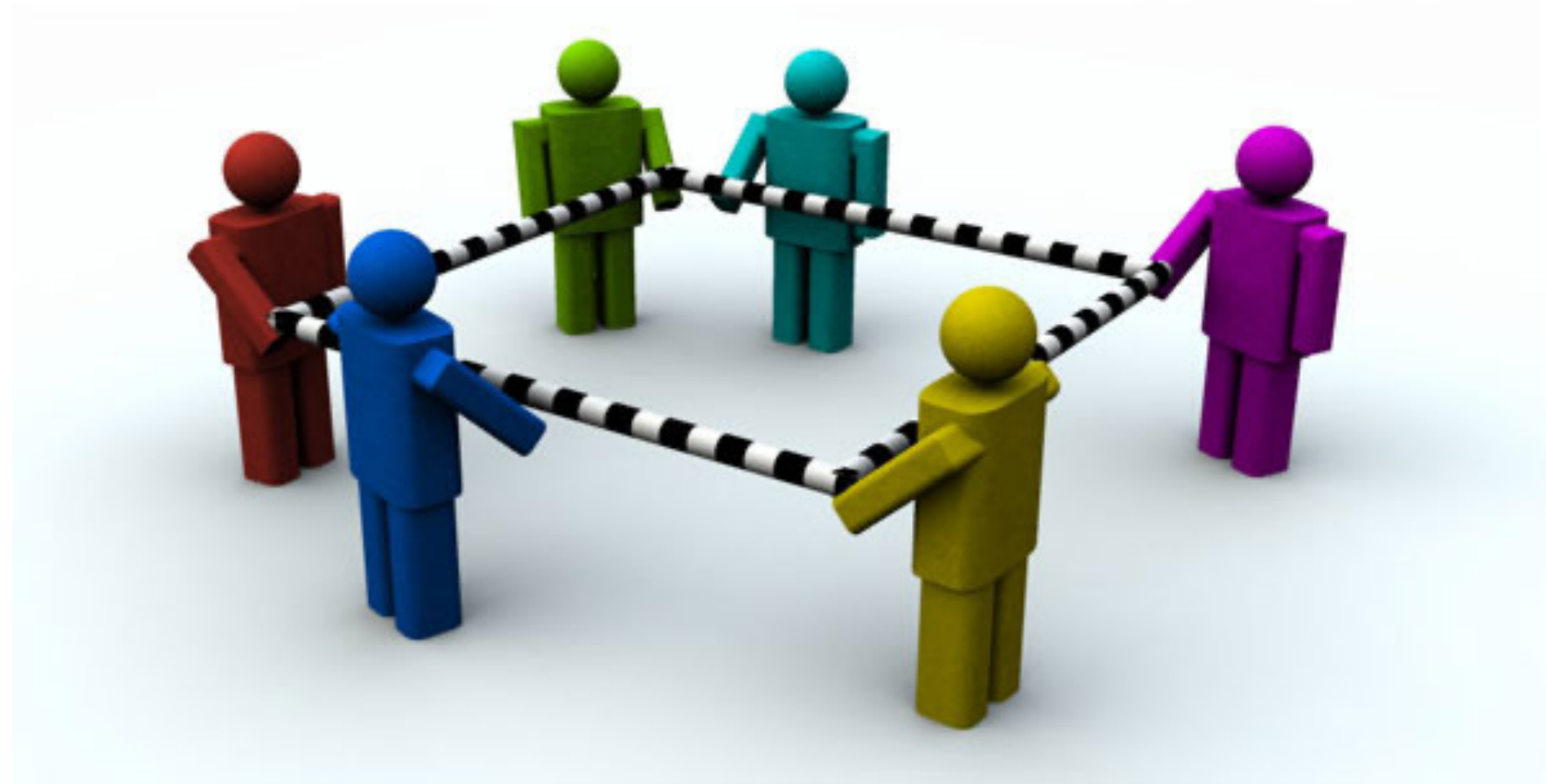

# Indoor Game

## Zoom and ReZoom

 20 – 30 mins

 20 – 100

Zoom from a farm to a ship to a city street to a desert island. But if you think you know where you are, guess again! For in these sleek, mysterious landscapes of pictures within pictures, nothing is ever as it seems. A great problem-solving activity for any group.

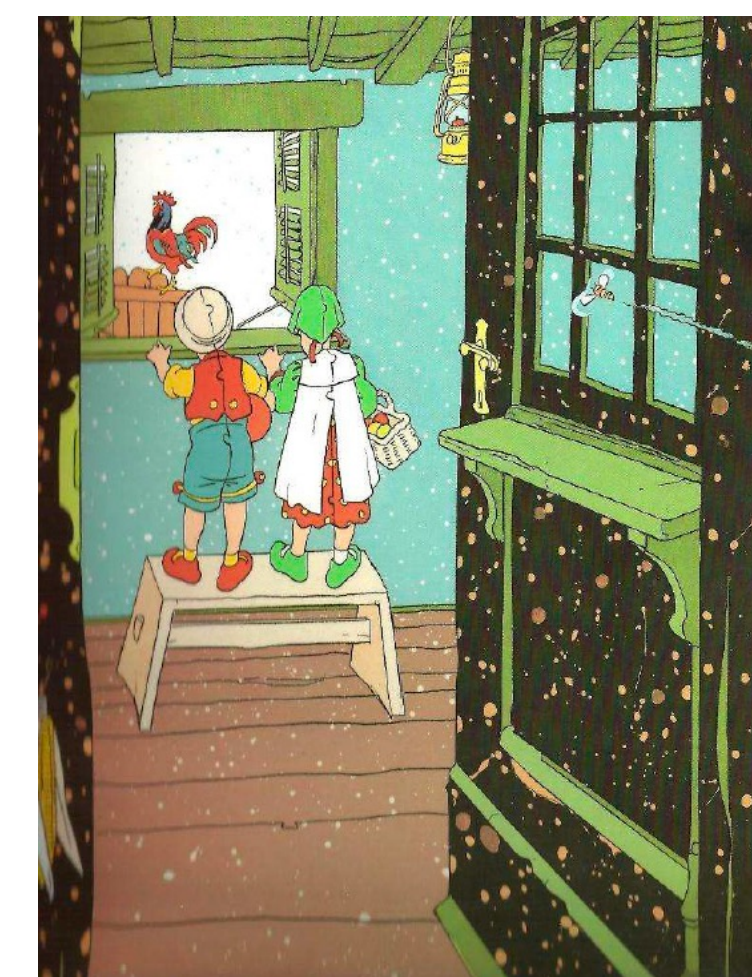

# Indoor Game

## Helium Stick

 20 – 30 mins

 10 – 50

The power of influence is very clear in this activity. Overcoming frustration and resisting the temptation to blame others is key for success. This activity is surprisingly difficult for most groups.

Have the team line up in two lines, facing each other, with their index finger extended from the hip. Have them lower the pole to the ground without losing contact with the pole.



# Indoor Game

## The Ball Game

 30 - 40 mins

 10 – 100

The Ball Game is simple but powerful exercise showing how creative thinking can literally transform the team's performance.

### Rules:

1. Create a process in giving and receiving the balls in the group
2. You cannot pass the ball to the person next to you
3. The ball must return to the person who started with it
4. The ball must travel through the air
5. The ball cannot be rolled across surfaces (e.g., floors, walls and tables)



# Indoor Game

## Build the Tower

 30 – 40 mins

 10 – 30

All people can use their strings to move the hook and stack the building blocks one by one. The aim is to stack the tallest tower without falling. This game requires team coordination, communication and strong focus



# Indoor Game

## Blocked Perspective

 30 – 40 mins

 10 – 30

Blocked Perspective helps to improve communication and allows the practice of healthy conflict by group discovery of the value of differing perspectives. Participants are challenged to accurately re-create block structures depicted on Photo cards.

This activity is fun, engaging and helps all team members see how their perspective is not necessarily the correct one or the only one of value. As participants engage and work together to solve the initiative they soon come to realize that by taking time to gather and consider all perspectives they are better able to be successful.



# Indoor Game

## Murder Mystery

 20 – 30 mins

 10+

Murder Mystery is a team game. Each player receives 1-5 clues regarding a mysterious murder. By sharing the 27 clues verbally, teams must work together to identify the victim, murder weapon, time and place of the murder, murderer, and motive.

Success requires organization, leadership, communications, listening, problem solving and processing skills.





# Indoor Game (Web Based) Trivia Quiz

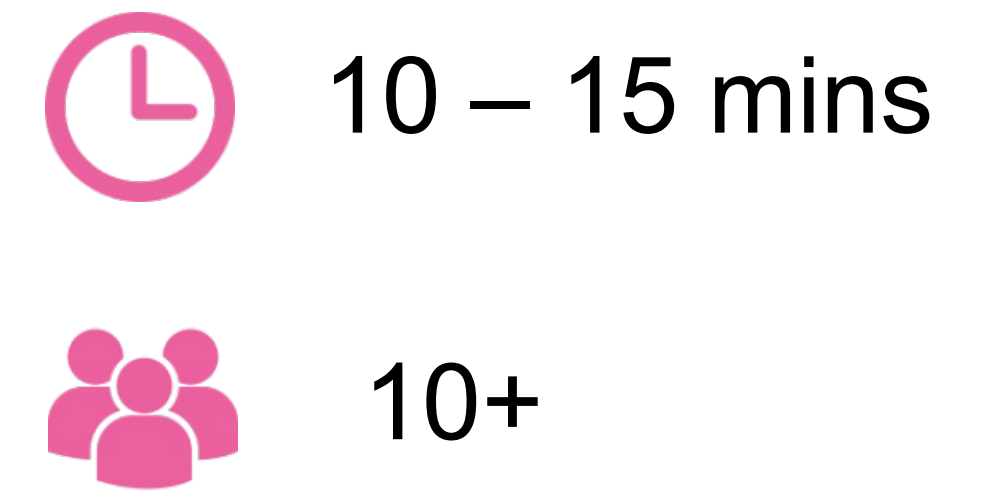

Trivia Quiz is a type of game in which players are asked questions about different topics and they have to get as many correct answers as possible. Trivia contests are usually organized as part of events, parties and as pub entertainment. Trivia Quiz can be part of the indoor game and can also be doing virtually through online platform



## Points:

Team(s) with the highest score will get **100 points**

Team(s) with the 2<sup>nd</sup> highest score will get **80 points**

Team(s) with the 3<sup>rd</sup> highest score will get **60 points**

Team(s) with the 4<sup>th</sup> highest score will get **40 points**

Team(s) with the 5<sup>th</sup> highest score will get **20 points**