

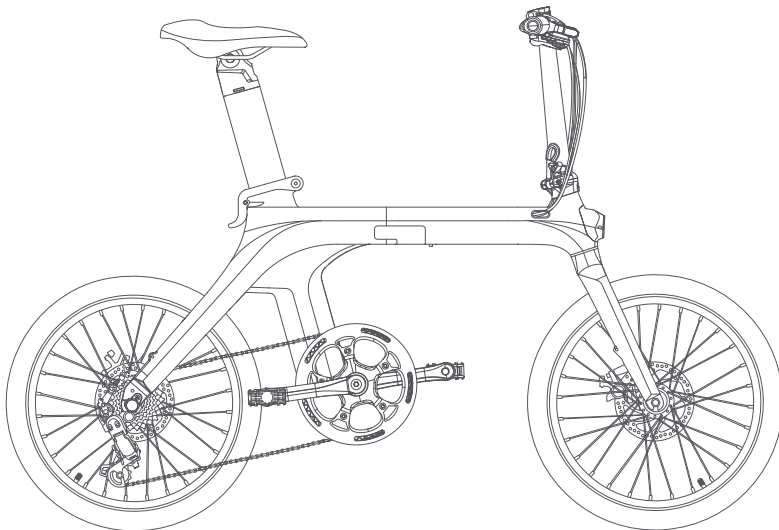

Fiido X

Folding Electric Bike



Dear users! Before enjoying the ride, please be sure to read the user manual carefully, understand the relevant operation specifications, and take good care of this user manual and the product certificate accompanying the ride. Don't use the Ebike until you fully know about the function.

Dear user:

In this manual, we will introduce you the common sense and maintenance of electric power bicycle. In order to better riding experience, please be sure to read and understand the product performance, characteristics, precautions and maintenance matters. If you have any questions, please contact the official after-sales team or local authorized service station. We will provide you with diagnostic assistance as soon as possible.

Safety precautions

1. Please follow the precautions in this instruction to effectively reduce risks. When you enter public areas, please obey national and local regulations, remain vigilant while riding, and maintain a reasonable safe distance from other people and vehicles.
2. Please operate by the instruction of the user manual, the loss caused by not following the instructions shall be borne by oneself.
3. This product is not professional off-road vehicle, do not use this product according to off-road vehicle standards.
4. For the first time riding, please do not choose the area with many children, pedestrians, pets, vehicles, or other obstacles and potential hazards. Please be familiar with the bike before riding on public road.
5. Before each ride, please carefully check whether fasteners are loose or parts are damaged. If there's any unusual noise, please stop riding immediately, and contact after-sales team for assist.
6. To reduce the injury risk, please read and follow all "Caution", "Danger" and "warning" instructions in this user manual. No speeding, and do not ride in motorized road under any circumstances.
7. For safety consideration, user must be over 16 years old. Users under the following circumstances are strongly not recommended to use this product:
 - People affected by alcohol or drugs.
 - People who are unable to engage in strenuous physical activity due to illness.
 - People who are unable to maintain balance or whose balance is impaired by motor skills.
 - People whose weight exceeds the max load limit (max load is 120KG/265lb).
 - Pregnant woman.

8. Please ride carefully in snow, rain, wet road, ice and other bad weather. Do not ride over too high or too large obstacles, otherwise it's very likely to lose balance or grip and cause injuries.
9. Do not attempt to charge while the charger or power supply is wet, please follow the local safety regulations if you need to charge the bike in public area.
10. For effective protection and as convenient as possible for yourself, please be sure to use Fiido specific parts.
11. If you need to retrofit your bike, Please follow the local laws and regulations, after consulting with Fiido after-sales team, then proceed with caution. Serious injury and/or damage caused by unauthorized modification will result in the void of warranty.

CONTENTS

1. Product introduction	2. Using guide	3. Maintenance precautions	4. Service directory
1.1 Bike overview	2.1 Installation guide	3.1 Using precautions	4.1 Troubleshooting methods
1.2 Packing list	2.2 First time using	3.2 Bike maintenance & repair	4.2 Specifications
1.3 Bike diagrams	2.3 Coded lock instructions	3.3 Motor maintenance & repair	4.3 Warranty coverage
1.4 Function DESC	2.4 Charging instructions	3.4 Battery maintenance & repair	4.4 Repair record
	2.5 Folding instructions	3.5 Reflex reflector cautions	

* All pictures are for reference only.

1.Product introduction

1.1 Bike overview

1.2 Packing list

1.3 Bike diagrams

1.4 Function DESC

1.1 Bike overview

THE FUTURE STARTS HERE

Fiido X inherits Fiido's consistently minimalist design aesthetics, the design of the whole bike has a sense of future technology. The body of Fiido X adopts a magnesium alloy integrated molding process, with a smooth and simple frame line. As the world's first folding electric bicycle with two built-in guide rails in the seat post to transmit battery power, it is equipped with a removable battery to solve the problem of travel charging. Also equipped with a leading torque sensor system and a high torque motor, which can sense the rider's will. The 7-speed mechanical transmission system can assist the rider to easily cope with various complicated roads.

The unique keyless security system provides a better anti-theft function. Equipped with 2 riding modes, 3 power-assisted modes, 7-speed mechanical transmission system, which provides riders a better and richer riding experience. The bike can be folded in three sections, the volume of the folded e-bike is less than 0.5 m³, which is a perfect balance of comfortable riding experience and portability.

1.2 Packing list

Bike parts

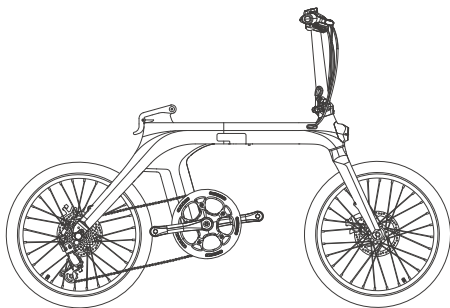

Electric Bike*1

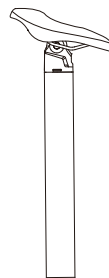

Seatpost battery*1

Bike accessories



Fenders*2



Pedals*2



Charger*1



Adapter*1

(Equipped for EU and UK regions)



User manual*1

Tools



Open spanner*1



Hex wrench*5



Hex wrench*1

*Please carefully check whether all items are complete and intact. If there is any problem such as missing or damaged, please contact the official after-sales team asap.

1.3 Bike Diagrams

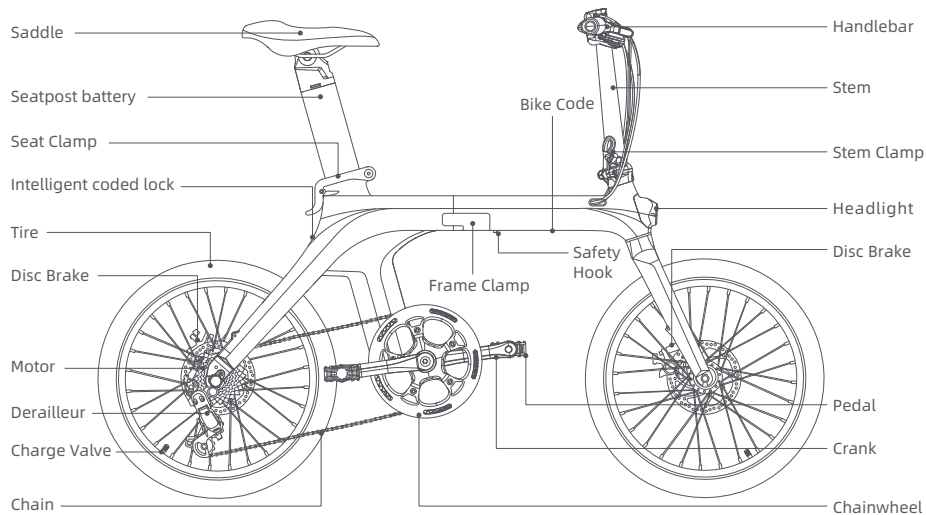

*Non professionals are forbidden to disassemble and assemble the battery.
Please contact after-sales team for assist.

1.4 Function DESC

Bike

Battery Status

(Display remaining power)

Instrument Power

① Long press for more than 3 sec: turn on/off the power assisted mode

② Short press for 1 sec: turn on/off the front and rear lights

Power Assisted Gear Switch
(Click to change the gear, a total of 3 gears)

Front Brake

(The left side is front brake)

Mechanical Bell

(In case of overtaking, road section affecting safety visibility or emergency, slow down and ring the bell for signal)

USB Charging Port

(For emergency charge ONLY)

Lights Display

(On means the front and rear lights are on)

Power Assisted Gear Display

(Display the current power assisted gear)

Speed

(Display the current speed)

Rear Brake

(The right side is rear brake)

Speed Gear Display

(Display the current derailleur gear)

7 Speed Shift Up

(Pull the handle outward to shift up)

7 Speed Shift Down

(Pull the handle outward to shift down)

Quick Release

(Open/close to adjust the handlebar)

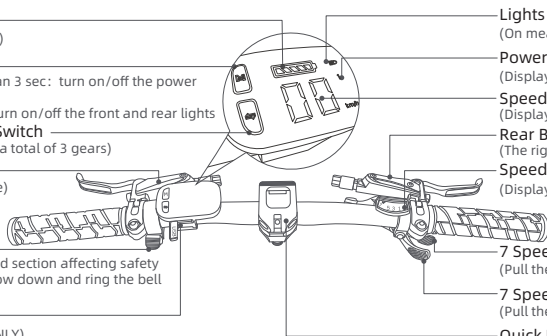

Battery

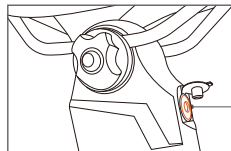

Charging Port

(Insert the Fiido charger ONLY)

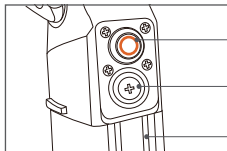

ON/OFF Button

(Click to turn on/off the battery power)

Fuse

(Battery protection, DO NOT touch)

Discharge Guide

(Battery discharge device, DO NOT touch)

Coded lock



Power Button

(Bike power button, enter the password and click the  button to start the bike power.)

Unlock Button

(Unlock the seatpost battery, enter the password then click the  button to remove the seatpost battery.)

2. Using Guide

2.1 Installation guide

2.2 First time using

2.3 Coded lock instructions

2.4 Charging instructions

2.5 Folding instructions

2.1 Installation guide

The basic installation of the bike has been completed before leaving the factory. After receiving the bike, you only need to unfold the stem, install the seatpost battery and pedals for complete installation.

Unfold the stem

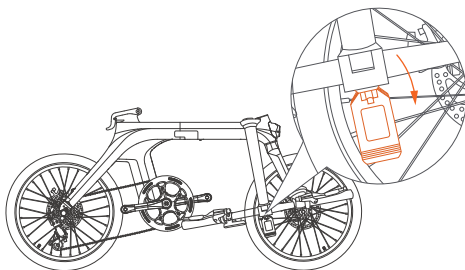

① Open the quick release, adjust the handlebar direction upward to loose the wire.

Caution: Please operate by the instruction, otherwise may cause wire breaking

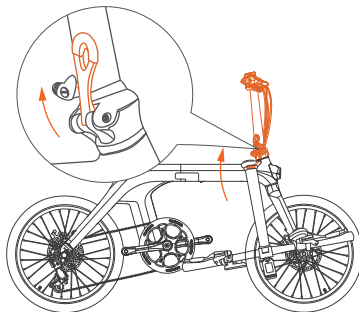

② Lift the stem from bottom to top, open the stem clamp, adjust the handlebar and close the stem clamp.

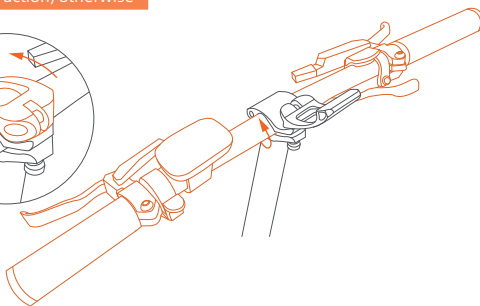
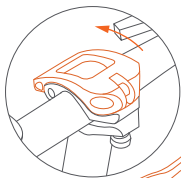
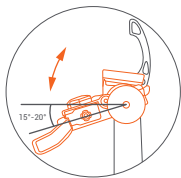

③ Adjust the handlebar direction, to make it at an angle of 15°-20° with the horizontal line, then close the quick release, to complete the unfolding stem.

Install the seatpost battery

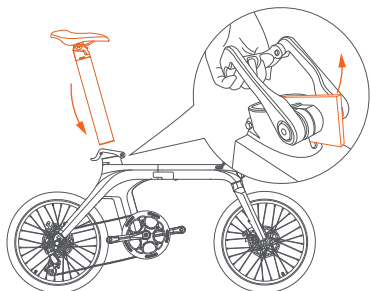

① Open the seat clamp, take off the EVA protective cotton, insert the seatpost battery.

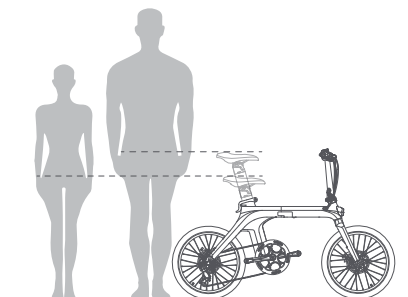

② Adjust the seatpost battery to suitable height, the recommended height is when the saddle is level with the user's pelvis when standing naturally.
(Caution: Do not adjust the height beyond the maximum and minimum heights on the battery holder scale.)

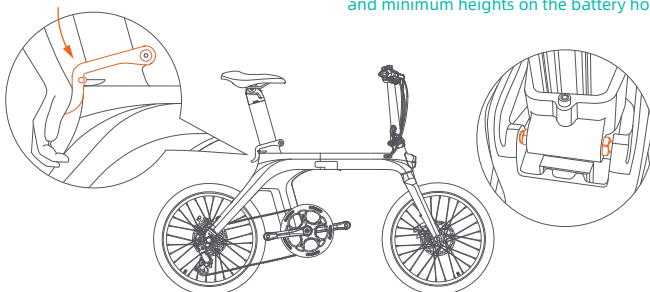

③ Close the seat clamp till the screws on the seat clamp is aligned, to finish the completed installation of seatpost battery.
(Caution: Using the coded lock and turn on the power, to check whether the battery is properly installed. If the power can be turned on normally, means the installation is successful. Please refer to P13 for details of coded lock operation.)

Install pedals

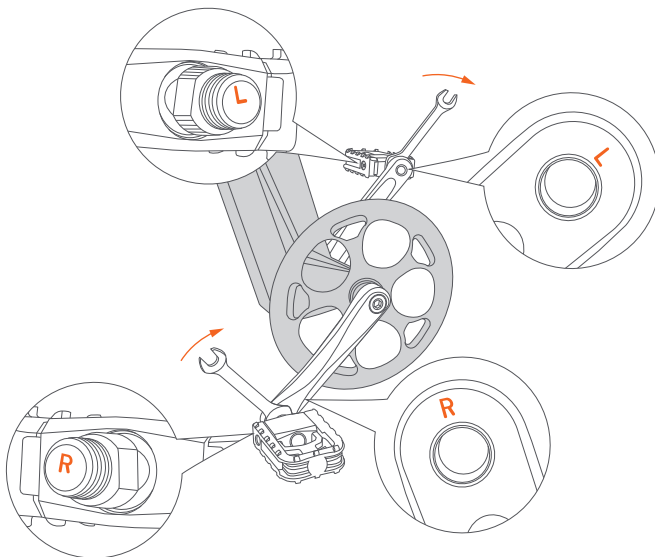

Use the open spanner of the tools bag, screw the pedal shaft into the threaded hole and tighten it in the direction of the arrow.

Caution: While installing the pedal, pay attention to the left / right pedal corresponding to the left / right crank, the pedal screw and the inside of the crank are respectively marked L(left) / R(right). Please install the pedal correctly to prevent it from sliding out of the crank.

2.2 First time using

Before riding, please follow the installation guide to install components properly, check whether the firmware is loose, ensure sufficient power, and take appropriate protection for riding.

Step 1: Adjust the seat

Please adjust the seat to the appropriate riding height according to your height.
(the recommended height is when the saddle is level with the user's pelvis when standing naturally.)

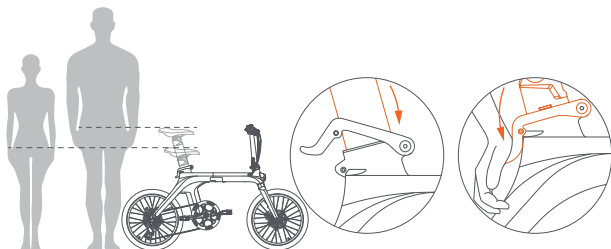

Step 2: Turn on the power

- ① Check the seat clamp to ensure it's in closed status.
- ② Click the ON/OFF button, to turn on the battery power.
- ③ Input the six-digit password then click the power button, to turn on the vehicle power.
(Please refer to P13 for details of coded lock operation.)

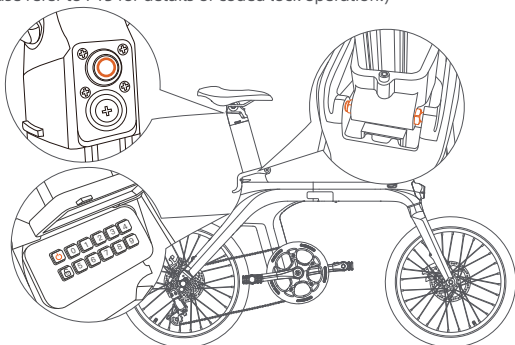

Step 3: Adjust the power assisted gear

Adjust the power gear according to the cycling road conditions.

(Equipped with 3 power assisted gears, the 1st gear is suitable for relatively flat road conditions, the more/higher the road slope, the larger gear can be adjusted accordingly.)

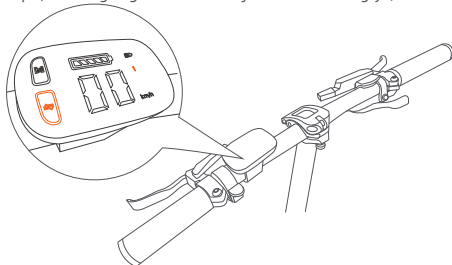

Step 4: Start riding

Please take corresponding protection before starting riding.

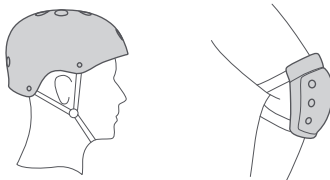

Step 5: Braking introduction

The left side is front brake, the right side is rear brake. While riding, it's recommended to use the rear brake first, then the front brake to slow down the speed to stop, in order to avoid the front wheel brake is too urgent, resulting in the bike center of gravity instability caused by falling accident.

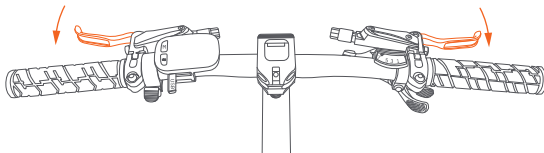

2.3 Coded lock instructions

The original password is "012345" . After receiving the bike, the password can be customized.
Please follow the following steps:

Password modification

1. Start the power: Input the original password "012345" + "⏻" , to start the bike power.
2. Change the password: ① Press "⏻" + "🔒" at the same time till 4 sec, then loose hand.
② Input the original password "012345" + "⏻" , then input the new six-digit password "*****" + "🔒" to finish the password modification.

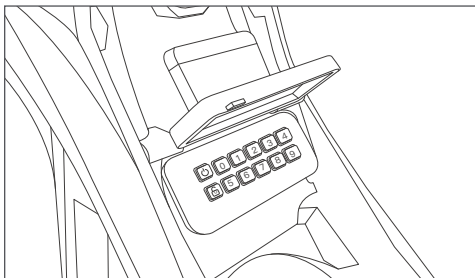

Caution:

- ① The setting will with a long beep if it's succeed.
- ② The setting will with 3 short beeps if it failed, then you may need to repeat the above steps, or contact the after-sales team by sending the operation video.

The coded password can be operated to turn on/off the bike power, and remove the seatpost battery. Please follow the following steps:

Turn on power

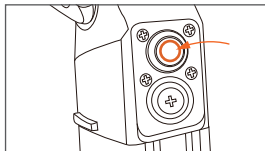

1. Click the ON/OFF button, to turn on the battery power. The green light is on means it succeed.



2. Input six-digit password, then click the power button to start the bike power.

Turn off power

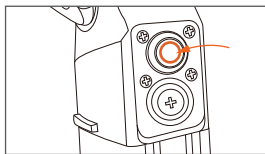

1. Click the ON/OFF button, to turn off the battery power and bike power. The green light is off means it succeed.

How to remove the seatpost battery

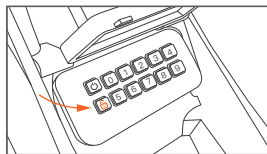

1. Input six-digit password, then click the unlock button. A long beep means unlocking the battery is succeed.

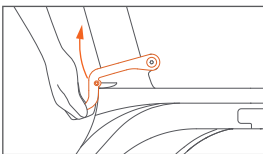

2. Open the seat clamp upward.

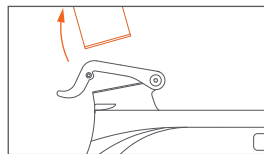

3. Lift the seatpost battery till it is completely detached from the frame, to successfully remove the battery.

2.4 Charging instructions

The seatpost battery comes with a small amount of electricity, before the first time use, please make sure to charge it to full power before riding.

Charging

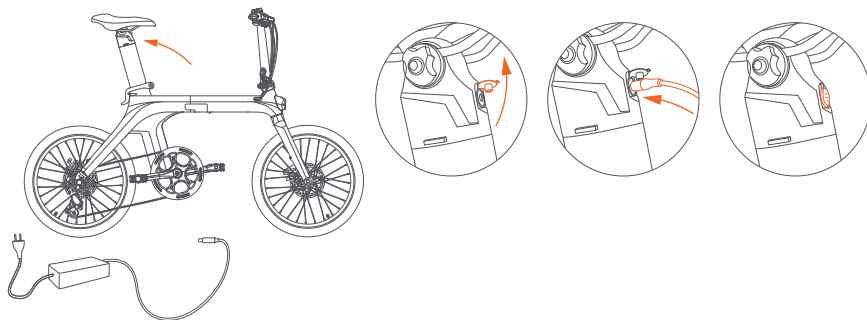

1. Charging connection: Connect the charging interface of the charger to the charging port, then connect the power plug of the charger to the power socket.
2. Fully charged: When the indicator light of the charger is red, means it's normal charging. When the light is green, means it's fully charged.
3. Charging hour: Charging hour is around 7-9 hours, The duration depends on the situation.
4. Disconnect charging: When the indicator light turns green, means it's fully charged. Unplug the power plug first, then remove the charging interface from the battery. Close the battery dust cover.
5. Charging mode: The bike supports two charging modes: vehicle charging and disassembly battery charging. Please see P13 for how to remove the battery.

Caution: Charger has high voltage device, DO NOT repair without permission. In order to avoid danger, battery and charger should be placed away from children. There should be no inflammable and explosive objects around the batteries (such as car seat cushions, sofas, etc.). Keep the battery in a ventilated and dry place, and make sure NOT to charge in open-air place, to avoid electrical short circuit fire and other accidents caused by rain and other factors, and to prevent liquid and metal particles into the electrical parts.

Danger: Charging can be allowed on public charging equipment, but the matching between the battery and the charging equipment should be fully considered.

Warning: If there's any odor or high temperature during charging, please stop charging immediately and contact after-sales team for assist.

2.5 Folding instructions

Lower the seatpost

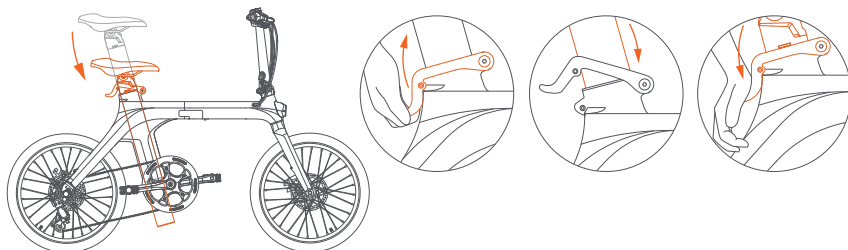

Lift the seat clamp upward, to keep it in open status. Gently press down the seatpost battery to the bottom. Press down the seat clamp to keep it in closed status.

Fold the stem

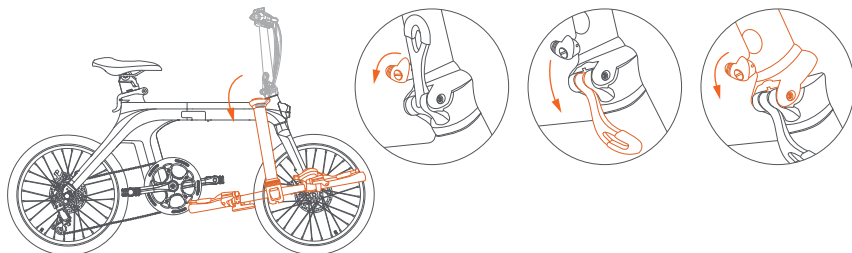

Open the stem safety hook, turn the stem clamp downward to keep it in open status. Gently turn the stem downward to the bottom, to finish the stem folding.

Fold the bodywork

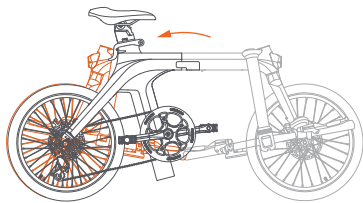
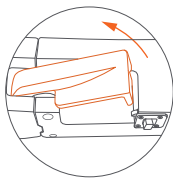
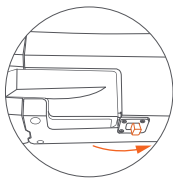

- ① Open the safety hook, open the frame clamp outward and keep it in open status.
- ② Fold the front part of the bike backward, to finish the bike folding.

3. Maintenance precautions

3.1 Using precautions

3.2 Bike maintenance & repair

3.3 Motor maintenance & repair

3.4 Battery maintenance & repair

3.5 Reflex reflector cautions

3.1 Using precautions

(I) Users should pay attention to the safety of bicycle use

1. No parking in building foyers, evacuation stairs, walkways and safety exits.
2. No charging in residential buildings. Charging should be far away from combustible, and no longer than 9 hours.
3. Prevent water from entering electrical parts. When cleaning the bike, avoid water impact on charging port, wiring harness connectors, fuse and other electrical parts.
4. When adjusting the height of the saddle, the safety line mark of the seatpost should not be exposed.
5. Users and dealers must not wiring and modifying structure and performance without permission. Such as: change the battery configuration, the circuit, increase the lamp power, increase the sound and other modification.
6. Do not touch the live part of the bike with wet hands or metal conductors. Such as: charging port, charger plug etc.
7. When replacing circuit breakers or fuses, use circuit breakers or fuses of the specified models and specifications. Do not short-fuse wires. The circuit breaker or fuse card slot should be in good contact, or may cause the accidents.
8. Please do not disassemble electrical parts without authorization to prevent liquid and metal particles from infiltrating into electrical parts.
9. Do not ride on bad weathers, or place the bike in a long-term exposure to the sun/rain to avoid parts aging.
10. If scrub the bike is needed, please wipe the body with a neutral lotion mixed with tap water. Do not remove and wash internal parts to avoid short circuit.

Caution: Non-professionals are strictly prohibited to repair. In case of failure, please contact the after-sales team or authorized professional maintenance station for maintenance..

(II) Riding safety: please follow the national and local traffic laws and regulations, pay attention to riding safety.

1. User must be over 16 years old. Do not lend to people who can not operate the bike to avoid the harm.
2. Please ride in Non-Motor Vehicle Lane, with the max speed no more than 25km/h.
3. Please carry persons or goods in accordance with local laws and regulations while riding.
4. Please be sure to wear a suitable safety helmet and fasten the helmet wind strap while riding.
5. The braking distance will be extended in rainy and snowy days, please pay attention to slow down, and try to avoid to ride on bad weathers. Inner short circuit and electrical parts damage may be caused if the water level reaches the center of the hub of the rear wheel motor, please noticed.
6. Please follow the local traffic rules carefully. No riding after drinking, and make sure to always ride with both hands.
7. Bright colors, relaxed, and comfortable suit are suggested for riding, and wear low-heeled shoes for riding is necessary.

(III) Examination before riding: please repair in time or go to the local maintenance point for repair, if there's any abnormality.

1. Please confirm the normal power use when using the kickstand and the rear wheel is off the ground.
2. Turn on the power, check whether the indicator light is normal, and the power supply is sufficient.
3. Check whether the mechanical bell and front/rear light are in good condition.
4. Confirm whether the handlebar and seatpost are adjusted to the appropriate position, that fastening screws and quick release are fastened. Be attention that the safety line should not be exposed.
5. Check the front/rear brake handle, brake adjustment should make the brake reliable and flexible reset.
6. Check whether the tire pressure is normal, no cracking, abnormal wear, nails, stones, glass and other sharp objects.
7. Check whether the front/rear wheel screws are locked, the side, rear and pedal reflectors are in good condition.
8. Check whether the front /rear lighting is normal and ensure that lights can be good used while riding.
9. Check the fastening state of each axle to ensure the front/rear axles are in a reliable state.
10. Check whether the frame clamp is locked before riding.

Caution: abnormal tire pressure, tire cracking damage and abnormal wear are the main causes of steering failure and tire burst.

(IV) Attentions on the road

1. For your safety and the safety of others, please obey the local traffic rules consciously.
2. Before riding, be sure to wear a safety helmet, take safety precautions and maintain a natural posture.
3. At the beginning of riding, please slowly accelerated, to avoid the energy waste or accidents.
4. For a longer service life of the battery and motor, when start riding or climbing, please try to use power assisted mode.
5. To ensure safety, economic speed should be used as far as possible, and reduce frequent braking, frequent start as far as possible, to save electricity.
6. avoid the phenomenon of tightening the speed control handle after braking.
7. Riding on muddy areas or uneven roads should use pendal mode as far as possible.
8. Braking distance should be appropriately increased on bad weathers, please be concentrated and careful while riding.
9. Equipped with overcurrent protection. The circuit may be overcurrent under the condition of higher uphill Angle and higher headwind speed. It's better to use pendal mode, otherwise, power consumption may be too fast to affect the range, motor and electrical appliances burn. The body and electrical parts should not be electriferous, the insulation resistance value shall not be less than 2M ω .
10. Controller has undervoltage protection, the power will be cut off automatically if the voltage is lower than the undervoltage value, to maintain the service life of the battery.

(V) Attentions of pushing and parking

1. The power should be off when pushing the bike, to avoid the accidents.
2. Parking should be on the level ground, and maintain the bike as power off status.
3. For your safety, please maintain and clean your bike regularly to keep it in the best condition.

3.2 Bike maintenance & repair

1. The bicycle has been adjusted well before leaving the factory. please contact after-sales team if there's any problems.
2. Normally the spokes of the wheel should be adjusted once after half a month of riding to ensure the best use.
3. Make sure to check the storage capacity of the tire regularly to keep it in normal use.
4. Make sure to check the main parts like handlebar, stem, saddle, seatpost, front/rear and centre axle, flywheel and chain, wheels, to keep it in normal use, nut and screw loose should be tightened in time if it loose.
5. In use, it's recommended to add 3# calcium base lubricating oil (butter) every six months to the parts that need lubrication (such as front/middle/rear axle bearing, front fork bowl group, foot pedal bearing, etc.). Add 30# oil to the chain, brake cable, support and other parts every two months
6. If the vulnerable parts are damaged, such as: brake line, brake skin, brake pad, bulb, fuse, etc. Please find the local maintenance center to replace, but be sure to replace with the same model specifications of the parts.

Cautions: Handlebar core screw fastening torque, combined handlebar joint screw fastening torque, saddle clamp screw fastening torque, front wheel fastening torque recommended torque is not less than 18NM;The recommended torque for fastening the central shaft lock mother and rear wheel is not less than 30NM. Handlebar and saddle tube safety line should not be exposed outside the body.

3.3 Motor maintenance & repair

1. Equipped with rare earth permanent magnet DC brushless, external rotor hub motor, without any deceleration mechanism and carbon brush, which is basically maintenance-free.
2. Do not open the motor base and end cover after sealing.
3. Keep the motor clean, no foreign matter, corrosive liquid, gas into the motor, do not knock and bake the motor shell, so as not to damage the motor.

Caution: If the fault cannot be removed, please consult after-sales team.

3.4 Battery maintenance & repair

1. Lithium battery has the characteristics of large capacity, long life, maintenance-free, light weight, pollution-free etc. Its service life is closely related to using mode. Do not store chronically, please form the habit of frequent charging.
2. It is recommended to charge for 7 - 9 hours each time, and the longest time is not more than 1 day. Lithium battery has no memory effect, can be used with the charge.
3. Make sure to charge for more than two hours every month under chronically store condition. Do not store the battery at a loss of power. Once the battery voltage reaches the discharge state, will cause unrecoverable damage.

Danger: Do not dismantle old battery without authorization, it should be collected according to regulations.

Warning: Do not near the fire or high temperature source, or throw it into the fire, or expose it to the sun.

3.5 Reflex reflector cautions

1. Reflex reflector device must not be missing, if it's missing, please immediately contact after-sales team for replacement, and the installation position should be consistent with the original bike.
2. Fiiido reflex reflector has been fixed on the vehicle, please do not change the position, modify, disassemble, etc.
3. Make sure to check the normal function of reflex reflector before each use, and keep the surface clean.
4. The reflector device must not be covered by luggage, children's chairs, clothing and other objects, otherwise it may cause safety hazard.

4. Service directory

4.1 Troubleshooting methods

4.2 Specifications

4.3 Warranty coverage

4.4 Repair record

4.1 Troubleshooting methods

Fault code description

Fault code	Fault phenomenon
E1	Communication issues
E3	Brake lever issues
E4	Motor hall issues
E5	Motor issues
E6	Controller issues

General fault

Fault phenomenon	Fault cause	Rule out way
Through-supply motor failure	Poor contact of regulating handlebar Poor contact of brake cut-off switch Motor damage Controller damage Loosened connector	Change regulating handlebar Change brake cut-off switch Change motor Change controller or get repair Check the connector
Lack of range	Tire pressure deficiency Undercharged or faulted charger Aging battery or damaged battery More uphill, gale, frequent braking, overload, etc	Blow up the tire Fully charged, check charger Change battery Using pedanal mode
Difficulty in charging	Loosened plug Disconnected battery cable Damaged charger	Tighten socket and connector Welded connector Change charger
Speed failure or low speed than 10KM/h	Poor contact of regulating handlebar Loosened connector Battery overvoltage	Change regulating handlebar Check the connector Fully charged

4.2 Specifications

Property index	Item	X Standard	X US
Product size	Before folding: Length*Width*Height (mm)	1490*580*1020	
	After folding: Length*Width*Height (mm)	794*350*803	
	Tires (Inch)	20*1.95	
Product weight	Net weight (kg)	19.8kg	
Riding requirement	Maximum load (kg)	120kg	
	Applicable age	16+	
	Applicable height	155cm(5.0') - 200cm(6.5')	
Main spec	Serial numbe Location	Under the frame	
	Maximum speed	15MPH (25km/h)	19.2MPH (32km/h)
	Maximum climb	25%	
	Center distance between wheels (mm)	980	
	Transmission	75 gears	
	Power assisted system	3 gears	
	Transmission ratio	52T: 14 - 28T	
	Applicable road	Urban asphalt pavement/flat pavement	
	Operating temperature	10° ~50°	
	Waterproof rate	IP54	
Battery	Rated voltage (V)	36	
	Battery type	Lithium battery	
	Rated capacity (Wh)	417.6	
	Battery management system	Overheat/short circuit/ overcurrent and overcharge protection	

Motor	Rated power (W)	250	350
	Rated speed (r/min)	270	327
	Motor type	Brushless geared motor	
	Undervoltage protection (V)	31±0.5	
	Overcurrent protection (A)	13±1	
Charger	Input voltage (V)	100-240	
	Output voltage (V)	42	
	Output current (A)	2	
	Charging hours (h)	7	
Others	Front light	LED	
	Tail light	LED	
	Riding mode	Power assisted mode+Pedal mode	

Caution :

* The above data allow for 5% manufacturing tolerances.

* After receiving the bike, there may be some differences between individual accessories and display drawings, which are different due to the different batches, and do not affect the use.

4.3 Warranty coverage

(I) Warranty principle

1. Users should operate correctly according to this user manual. In case of performance failure caused by production quality, according to relevant laws and national provisions of the three guarantees, the company shall uniformly perform the obligations of the three guarantees.
2. The faults beyond the warranty scope and the main parts after the warranty period shall be repaired by the company but shall be charged at the discretion.
3. Regards the battery replacement after the warranty period, will be charged with the factory price, but the old battery must be returned to the manufacturer, to ensure safety and avoid environmental pollution.

(II) Warranty scope and period

Item	Parts	Guarantee time	Service
Basic parts	Frame	36 months	Natural deformation, open welding, desoldering fracture phenomenon, quality problems caused by poor manufacturing can be replaced. Self-modification, collision damage, etc. are not warranted.
	Fork, Handlebar, Stem, Seatpost	12 months	
	Kickstand, Tires, Saddles, Fenders, Safety hook, Seat clamp, Stem clamp, Frame clamp, Pedals, Brakes, Brake discs, Brake levers	3 months	Tire puncture by sharp objects, collision damage of spare parts, etc. are not warranted.
	Crank chain disc, Front arm set, Hub, Wheel hub, Spokes, Shift finger dial, Derailleur, Flywheel, Chian, Bottom bracket, Shock absorber	6 months	Man-made damage, self-modification, collision damage of parts and accessories are not warranted.
Electrics parts	Controllor	12 months	Short circuit, burnout, performance failure due to poor manufacturing can be replaced. Water, disconnection, and man-made damage are not warranted.
	Charger, Main wiring harness	12 months	
	Display instrument, Speed control knob, Booster, Controller cover plate	6 months	
	Headlights, Taillights, Power-off brake levers, Switches	3 months	
Motor parts	Motor, Hall, Bearing, Clutch	12 months	Phase loss, Hall element burnout, demagnetization, abnormal bearing noise can be replaced. Breakage, water ingress are not warranted.
Battery	Lithium battery	12 months	Replace the battery due to faults such as broken grids, no power storage, and less than 70% capacity. No warranty for water ingress or man-made damage.

(III) The scope and content exceed warranty

1. Failure caused by user's failure to use, maintain and adjust according to the User Manual.
2. Failure caused by private modification.
3. Failure caused by improper use or storage by users or accidents.
4. No warranty card, or card and bike do not match.
5. Vulnerable parts and consumables, including plastic parts, spokes, rim, brake line, scratching surface etc.
6. The expenses for self-repair without the consent of the specially contracted maintenance unit.
7. After accessories leaving the factory, shell scratches or shell damage will not enjoy warranty.
8. Lead scratches or breaks.

Warranty notification

1. Accessories will be guaranteed in strict accordance with the warranty period.
2. The warranty period shall be calculated from the date of delivery.
3. No warranty will be provided if the charger, battery and motor are disassembled without permission.
4. For other parts of the bike, the quality issues will be provided three months warranty , others will not be warranty.
5. When other parts of the bike has issues, maintenance must be carried out in a professional maintenance centre, not private disassembly. Controllers, batteries, chargers must be ensured that all labeling integrity.
6. maintenance must comes with the warranty card, invoice, certificate of quality and other relevant documents.
7. The battery warranty method is 1:1. In case of battery problems, the battery should be returned to the manufacturer to determine whether the battery is covered by warranty according to battery testing standards.

4.4 Repair record

Warranty card

User	Company			
	Name		Phone	
Address				
Purchase date			Color	
Model			Order No	
Frame No			Motor No	

Repair record

Date	Maintenance	Remarks

Shenzhen Fiido Technology Ltd
Address: Shenzhen, Guangdong, China.
Website: www.fiido.com

If you have any questions or suggestions about this user manual,
please contact us via following mailaddress
Contact us: support@fiido.com



Scan for video instruction



Made in China



6974033532491