



GDI-8035-01 / GDI-8065-01 / GDI-8535-01
3 & 4-5 Person Corner Saunas



OWNER'S MANUAL

FOR CARBON MODEL SAUNA

FOR INDOOR USE ONLY

120VAC 20 AMP DEDICATED CIRCUIT

Sauna: Now you can enjoy the European secret for youthful vitality. Carefully and thoroughly read this manual before using the sauna. We recommend keeping this manual for regular review and future reference.

PLEASE READ INSTRUCTIONS BEFORE ASSEMBLY

GDI-8035-01

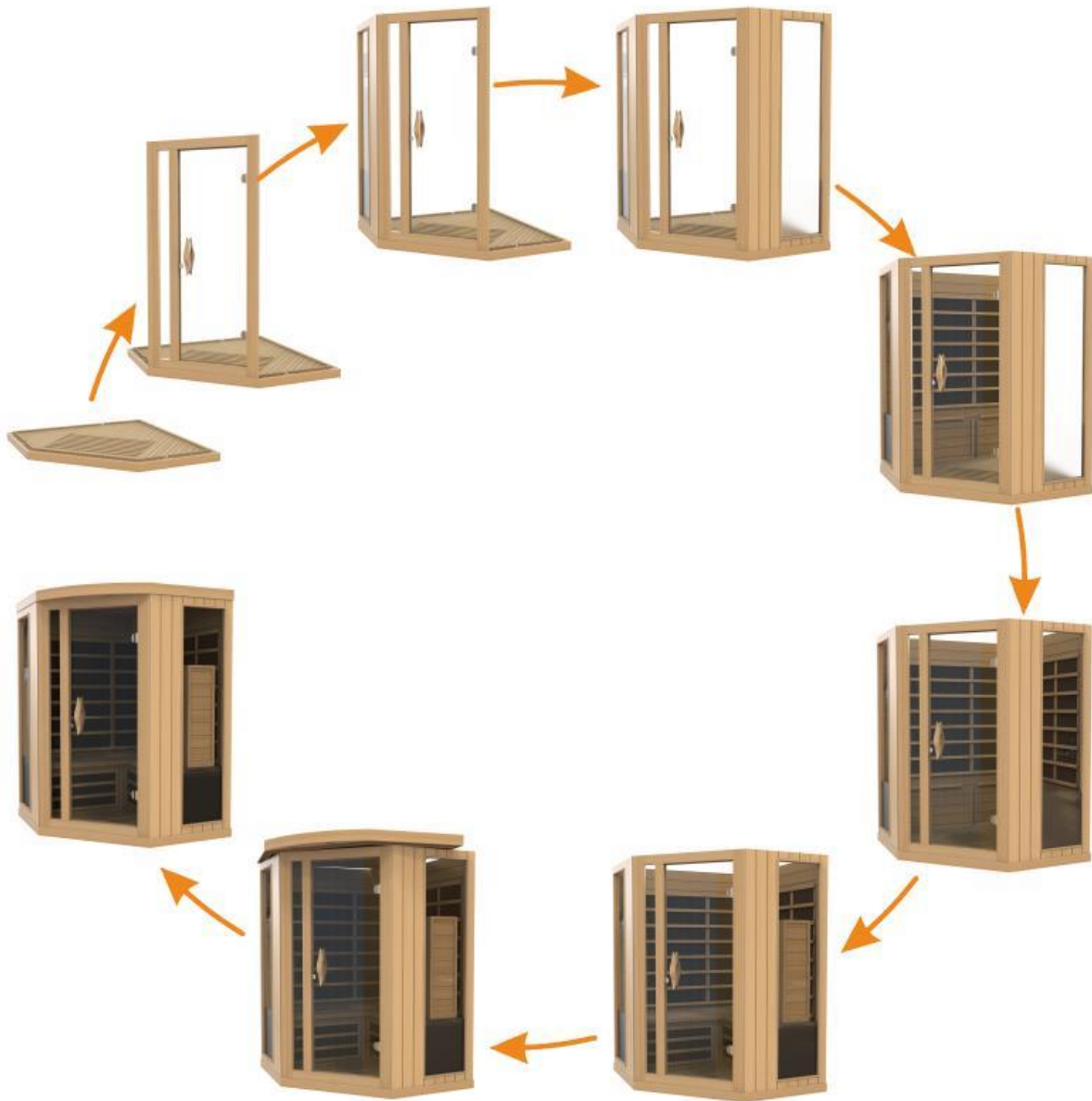

***The above assembly diagrams are quick reference visual guides only. All sauna models are not shown. Sauna models, parts, and accessories may vary. Near Infrared Heaters and backrests are sold separately. Use of the optional NEAR Infrared Heaters will increase the EMF.**

PLEASE READ INSTRUCTIONS BEFORE ASSEMBLY

GDI-8065-01

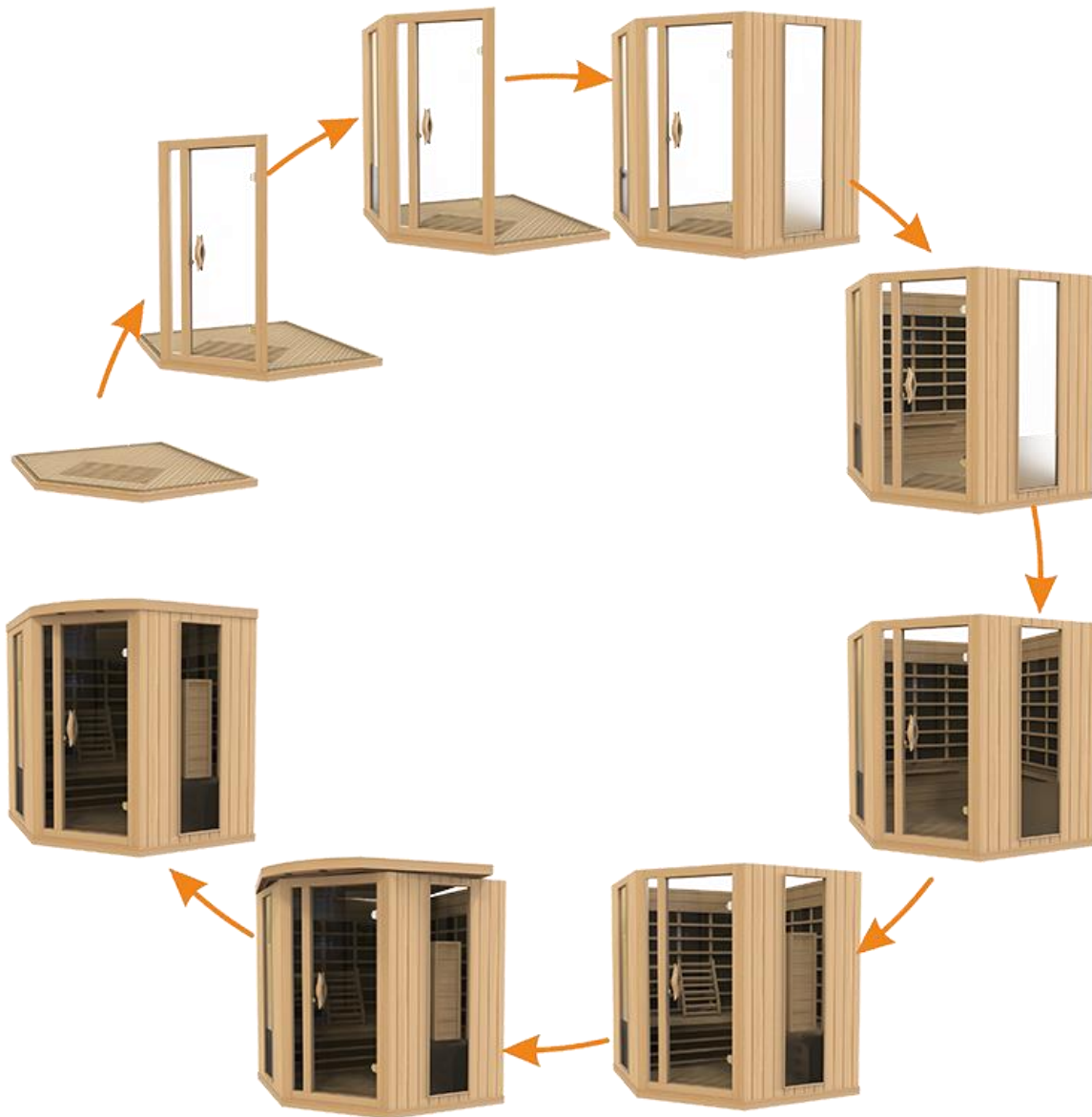

***The above assembly diagrams are quick reference visual guides only. All sauna models are not shown. Sauna models, parts, and accessories may vary. Near Infrared Heaters and backrests are sold separately. Use of the optional NEAR Infrared Heaters will increase the EMF.**

PLEASE READ INSTRUCTIONS BEFORE ASSEMBLY

GDI-8535-01

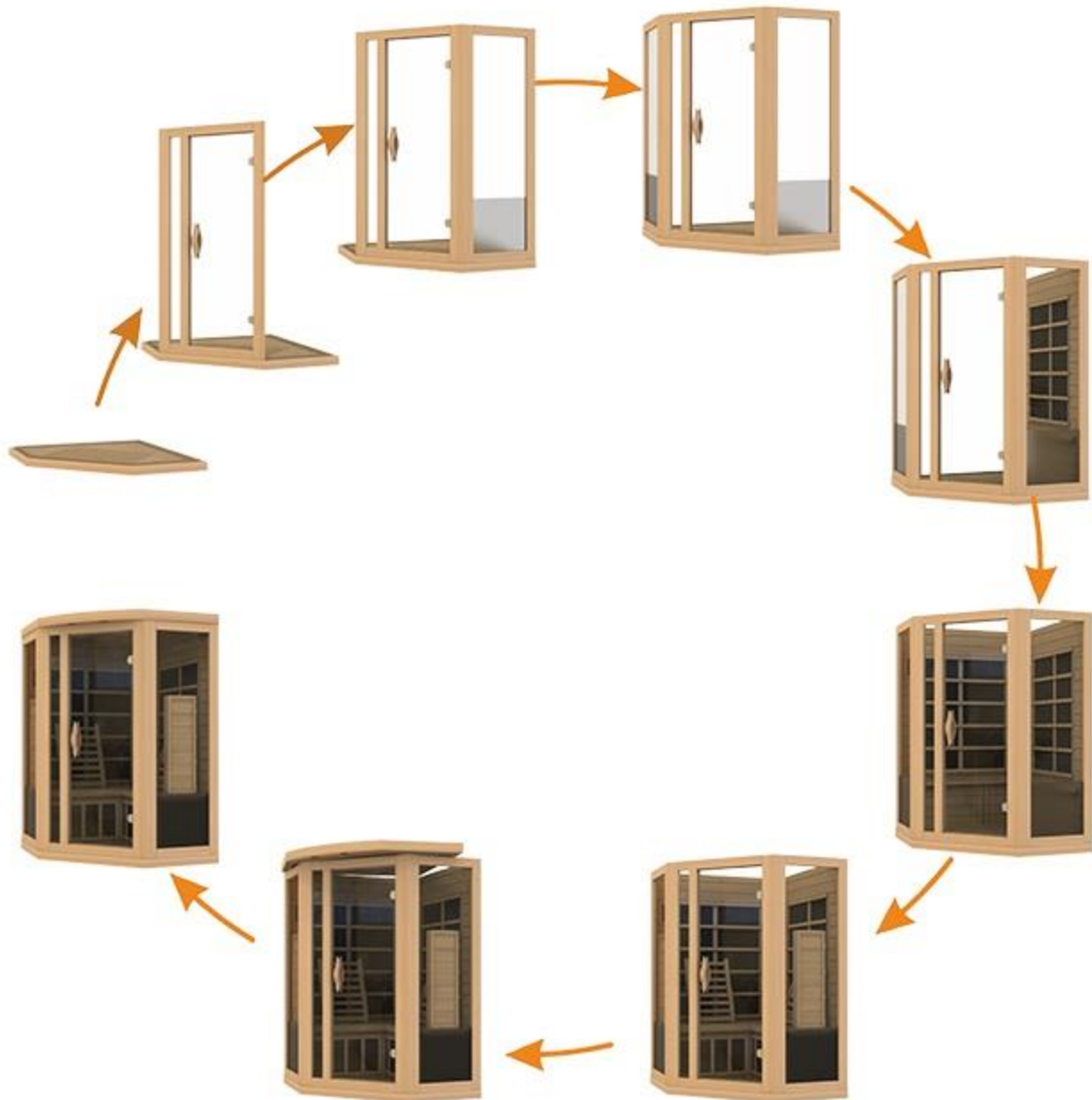

***The above assembly diagrams are quick reference visual guides only. All sauna models are not shown. Sauna models, parts, and accessories may vary. Near Infrared Heaters and backrests are sold separately. Use of the optional NEAR Infrared Heaters will increase the EMF.**

WHAT ARE INFRARED RAYS?

Infrared is the band of light we perceive as heat. We cannot see this band of light with the naked eye, but we can feel this type of light in the form of heat. Our sun produces most of its energy output in the infrared segment of the spectrum. Infrared rays heat your body without having to heat the air in-between. This process is called **conversion**.

The infrared is divided into 3 segments by wavelengths measured in microns: near infrared: 0.76-1.5 microns; middle infrared: 1.5-5.6 microns; and far infrared: 5.6-1000 microns. Among these segments, only far infrared penetrates organic substances such as the human body two to three inches so that the warming effect is very uniform.

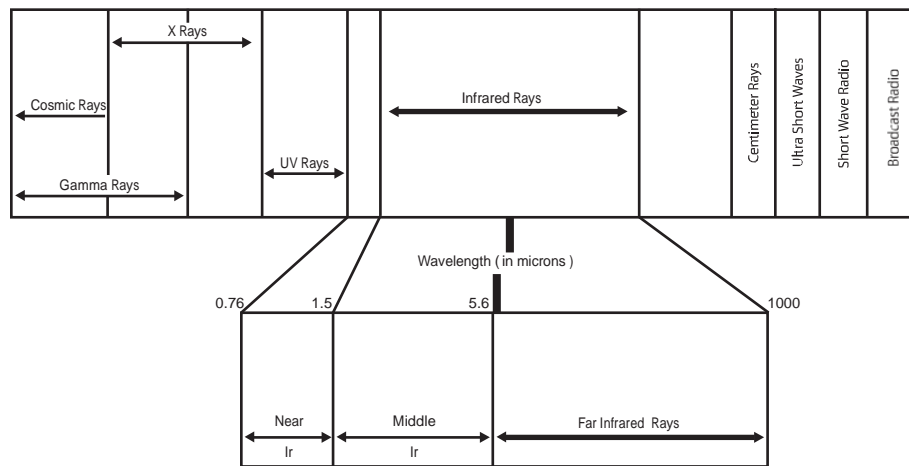

ARE INFRARED RAYS SAFE?

Because infrared rays are part of sunlight, they are not only safe but also highly beneficial to our bodies on a cellular level. Health professionals have used infrared heat lamps for decades to **treat muscle and joint problems**. In hospital baby care units, incubators are often equipped with infrared heating systems to **keep newborn babies warm**.

WHAT IS AN ELECTROMAGNETIC FIELD (also known as EMF)?

An Electromagnetic Field is a physical field produced by electrically charged objects. It is one of the fundamental forces of nature. The field can be viewed as the combination of an electric field and a magnetic field. The electric field is produced by stationary charges and the magnetic field by moving charges referred to as currents. Although all of our sauna products have been developed to have low EMF, this specific model uses our advanced carbon panel technology which significantly reduces the amount of EMF exposure resulting in ultra-low EMF or less than 3 milligauss (mG).

HOW IT WORKS

Infrared Saunas differ from traditional saunas in that they use infrared radiant energy to directly penetrate into the body's tissue to produce perspiration.

Traditional saunas use steam to heat the air inside the sauna, which then heats your body until you begin to perspire. In order for this to be effective, temperatures would need to reach in the upwards of 190 degrees Fahrenheit. Infrared saunas only need a temperature of up to 120 degrees Fahrenheit to obtain the same effect. This lower temperature makes the environment more tolerable and allows you to breathe easier.

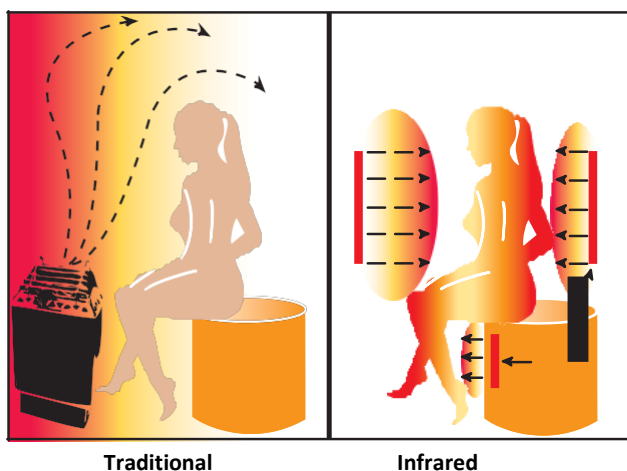

BENEFITS

Because infrared rays penetrate the body through convection, there is a deep heating effect in both the muscle tissues and internal organs without putting too much burden on the heart.

Our body reacts to the increased heating through the **natural cooling process of perspiring**. Through the perspiration process, **acid and waste residue** like toxins, sodium, alcohol, nicotine, cholesterol and the potentially carcinogenic **heavy metals are removed from the cells** (especially zinc, lead, nickel, cadmium, etc). The pores of our skin open and discharge waste products shedding any old skin cells leaving the skin glowing and clean, with improved tone, elasticity, texture, and color.

Over the last 25 years, Japanese and Chinese researchers and clinicians have completed extensive research on infrared treatments and have reported many provocative findings. In Japan, there is an "infrared society" composed of medical doctors and physical therapists dedicated to furthering infrared research. Their findings support the health benefits of infrared therapy as a method of healing.

Benefits include, but are not limited to:

- Pain relief from Rheumatoid Arthritis
- Relaxing muscle spasms
- Increases blood circulation
- Cardiovascular conditioning
- Clears rashes, acne
- Reduces cellulite
- Removes toxins and mineral waste
- Reduces stress and fatigue
- Enhances skin tone

SAUNA MAINTENANCE

Since infrared saunas do not require hot rocks, water, or steam to operate, they require very little maintenance. You can simply wipe it down with water and a soft clean cloth. **Do not use any cleaning chemicals** as they can be absorbed into the wood and be released into your sauna during use.

DISCLAIMER

The infrared rays emitted by your sauna are reported to offer a wide range of possible therapeutic benefits based on research completed over the last 25 years from all around the world. These benefits are presented for reference purposes only and no implication of infrared saunas creating a cure for or treating any disease is implied nor should it be inferred. If you have a health condition, are taking prescription drugs, or have acute joint injuries, please consult your physician before starting infrared therapy. Persons with surgical implants (metal pins and rods, artificial joints, silicone, or other types of surgical implants) typically do not experience any adverse effects, but should also consult their physician or surgeon before starting infrared therapy.

CAUTION: Exit sauna immediately if you feel dizzy, sleepy, or any discomfort.

TABLE OF CONTENTS

Product Introduction	7
Parts Description	8
Assembly Instructions	15
Operating the Sauna	23
Tips for Using Your Sauna	26
Safety Instructions	26
Safeguards for Your Sauna	27
Troubleshooting Guide	28
Warranty	30
Warranty Card	32

WARNING: Visually inspect all heaters before assembly to make sure they are not damaged. Any excessive vibrations during transport could cause damage to the heating elements. DO NOT START the sauna if damage is detected! Contact your dealer or manufacturer for troubleshooting and replacement parts.

1. Product Introduction

The infrared sauna room is composed of a wood cabin, infrared heat emitters, and a control system. The wood cabin includes a FRONT PANEL, LEFT REAR PANEL, RIGHT REAR PANEL, LEFT SIDE PANEL, RIGHT SIDE PANEL, BENCH PANEL, BENCH EMITTER PANEL, FLOOR PANEL, ROOF PANEL, and ROOF COVER. The infrared sauna comes with control panels on the FRONT PANEL, a back protection grid on the LEFT and RIGHT REAR PANELS, a drink shelf, a reading lamp, and infrared heat emitters.

NOTE: The pictures and diagrams shown within this owner's manual are representations of this model. Actual model may vary. Design and Construction are subject to change.

PARTS DESCRIPTION

GDI-8035-01

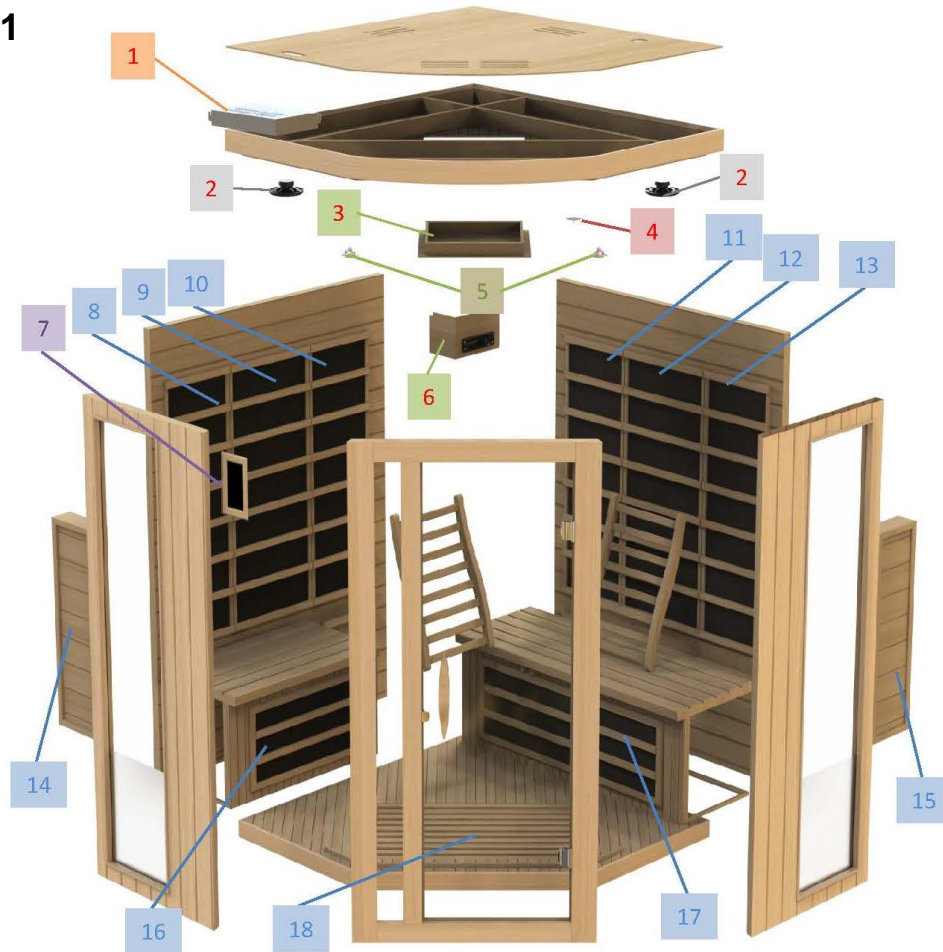

Electrical	
No.	Name
1	power supply
2	speakers
3	color therapy
4	temperature sensor
5	roof lights
6	CD player
7	control panel

distribution			
site	No.	dimension	power
left-back wall panel	8	1000*400mm	300W
	9	1000*300mm	200W
	10	1000*400mm	300W
right-back wall panel	11	1000*400mm	300W
	12	1000*300mm	200W
	13	1000*400mm	300W
left side wall panel	14	red bulb	300W
right side wall panel	15	red bulb	300W
bench heater panel	16	600*300W	125W
	17	1000*300mm	200W
floor wall panel	18	750*500	300W
Total			2225W

NOTE: The pictures and diagrams shown within this owner's manual are representations of this model. Actual model may vary. Design and Construction are subject to change. Backrests are sold separately.

PARTS DESCRIPTION

GDI-8065-01

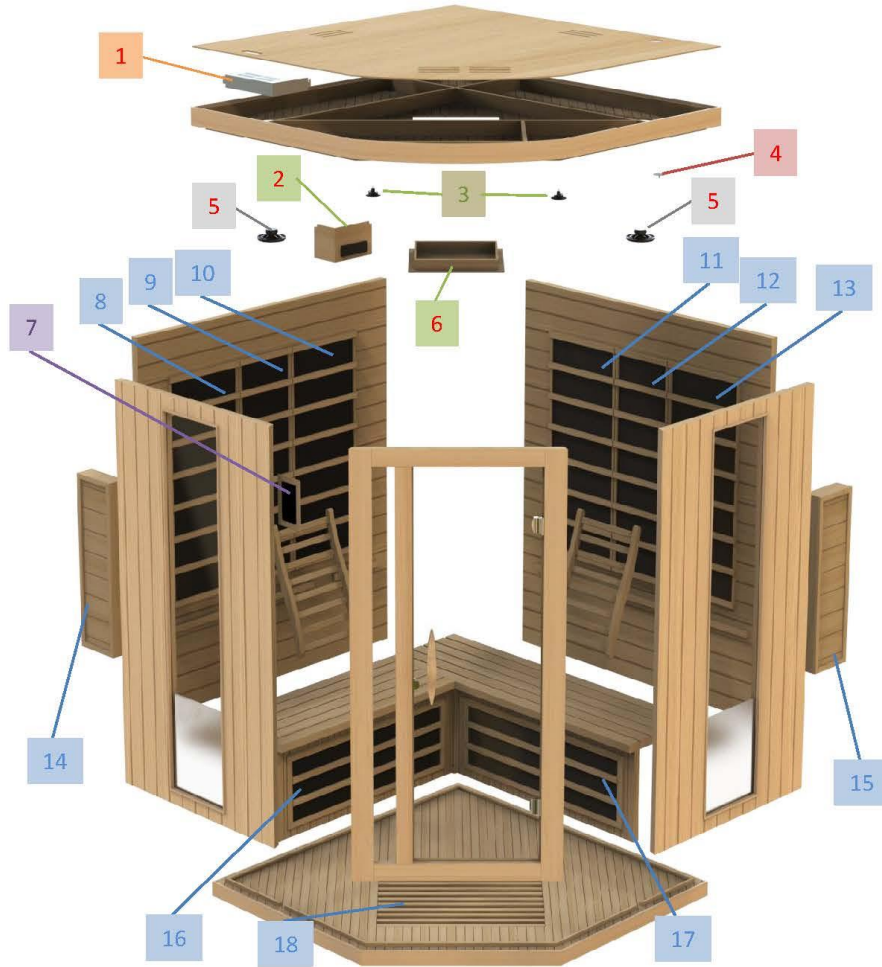

Electrical	
No.	Name
1	power supply
2	CD player
3	roof lights
4	temperature sensor
5	speakers
6	color therapy
7	control panel

Distribution			
site	No.	dimension	power
left-back wall panel	8	1000*400mm	300W
	9	1000*300mm	200W
	10	1000*400mm	300W
right-back wall panel	11	1000*400mm	300W
	12	1000*300mm	200W
	13	1000*400mm	300W
left side wall panel	14	red bulb	300W
right side wall panel	15	red bulb	300W
bench heater panel	16	1000*300mm	200W
	17	1000*300mm	200W
floor wall panel	18	750*500	300W
Total			2900W

NOTE: The pictures and diagrams shown within this owner's manual are representations of this model. Actual model may vary. Design and Construction are subject to change. Backrests are sold separately.

PARTS DESCRIPTION

GDI-8535-01

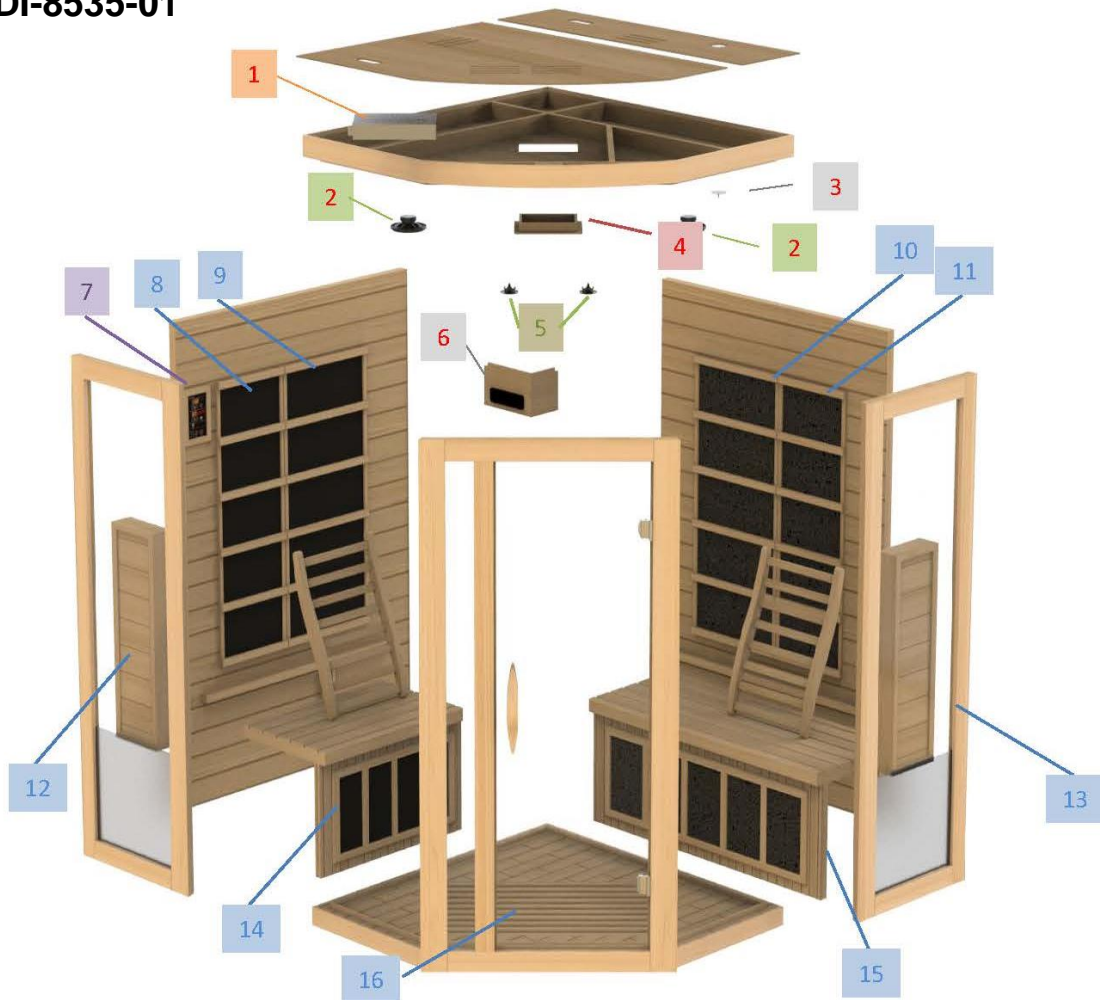

Electrical	
No.	Name
1	Power Supply
2	Speakers
3	temperature sensor
4	color therapy
5	roof lights
6	CD player
7	control panel

Distribution			
site	No.	dimension	power
left-back side wall panel	8	1000*300mm	200W
	9	1000*400mm	300W
right-back side wall panel	10	1000*300mm	200W
	11	1000*400mm	300W
left side wall panel	12	red heater	300W
right side wall panel	13	red heater	300W
short-bench heater panel	14	600*300mm	125W
long-bench heater panel	15	1000*300mm	200W
floor panel	16	1000*400mm	300W
total			2225

NOTE: The pictures and diagrams shown within this owner's manual are representations of this model. Actual model may vary. Design and Construction are subject to change. Backrests are sold separately.

I. Power Supply

The POWER SUPPLY BOX is the control center of the sauna room. It is installed on the ROOF PANEL and has input/outputs connected to it as seen below. (see Figure 1)



Figure 1

MAIN POWER
HT1, HT2, HT3, HT4
LIGHT
ROOF LAMP
CTRL
CD/SIG

main power of the sauna room
emitter power output cords
reading lamp power output cord
roof lamp power output cord (optional)
control panel connection
signal cable group

II. CD/Radio (optional)

The multifunction stereo features an FM receiver, CD player, colorful and wide LCD screen, volume /tone/balance controls, and an AUX input. (see Figure 2)



Figure 2

Model Radio May Vary)

III. Component Labeling

POWER	Power Cord
HT1, HT2, HT3, HT4	Emitter (heater) power cords
LIGHT	Reading lamp connector
ROOF LAMP	Roof lamp connector (optional)
COLOR LAMP	Color lamp connector (optional)
CTRL	Control panel connector
CD/SIG	For CD/temperature sensor/buzzer/etc. connectors
CD-POWER	CD/radio power connector FAN-
POWER	CD/radio fan power connector
ANALOG AUDIO	Audio frequency signal connector
L/SPEAKER	Left speaker connector
R/SPEAKER	Right speaker connector
BUZZER	Buzzer connector
TEMP SENSOR	Temperature sensor

IV. Buckles

A. External Buckles

The external buckles are used to connect the REAR PANELS to each other. Also, they are used to connect the RIGHT REAR PANEL to the RIGHT SIDE PANEL and the LEFT REAR PANEL to the LEFT SIDE PANEL. (see Figure 3)

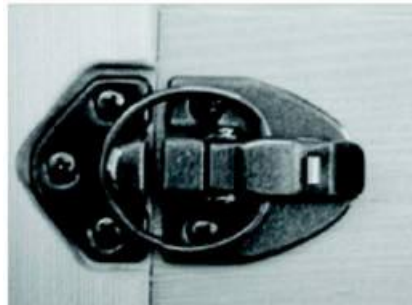

Figure 3

B. Guide and Guide Inserts

The guide and guide inserts are used to connect the LEFT SIDE PANEL and the RIGHT SIDE PANEL to the FRONT PANEL. (see Figure 4)

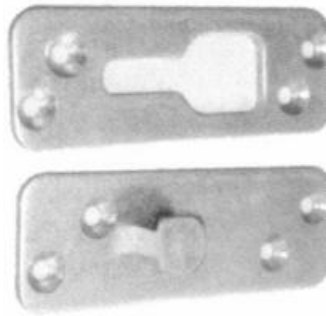

Figure 4

V. Panel Descriptions

For easier installation, please understand and distinguish the differences between each panel.

A. Floor Panel

When the floor panel faces upward, you will find that the edges are raised. The wall panels will seat inside of the raised edge. The front of the floor panel is indicated below. Please note the correct position before you began assembling the wall panels. (see figure 5)

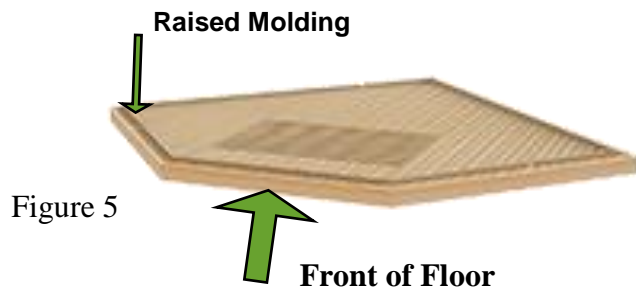

Figure 5

B. Understanding The Difference Between The Top And Bottom Of The Wall Panels

The wall panels are in the upright position when the ¼ round molding on the interior wall panels is at the top. In addition, the heater cords are also at the top. Place the heater cords to the outside of the sauna room before the roof is placed on top of the unit. These heater cords will be feed through the roof panel and connected once the roof panel is placed on top of the sauna room. (see Figure 6)



Figure 6

C. Rear Panels

If you are facing the front of the sauna, the rear panel with the heat emitter panels on the interior will be the inside of the sauna room. (see Figure 7)



Figure 7

Assembly Instructions

A. Choose a good location to assemble the sauna

1. The location must be dry, leveled, and away from any source of water
2. MAIN POWER cord must be easily accessible
3. Two adults are required for installation
4. Wood cabin installation order: Floor Panel ► Front Panel ► Left Side Panel ► Right Side Panel ► Left Side Rear Panel ► Right Side Rear Panel ► Bench Emitter Panels ► Benches ► Roof Panel ► Roof Cover
5. Tools Required: Philips Screwdriver and Ladder

B. Installing the FLOOR PANEL

1. Place the FLOOR PANEL on the floor. Turn the FLOOR PANEL right side up and make sure the front is positioned correctly. (see Figure 8)



C. Installing the FRONT PANEL, LEFT SIDE PANEL, and RIGHT SIDE PANEL

1. Determine the correct placement of the FRONT PANEL in the figure diagram below. Insert the FRONT PANEL onto the FLOOR PANEL. Then place the LEFT SIDE PANEL onto the FLOOR PANEL next to the FRONT PANEL. Lift the LEFT SIDE PANEL up and onto the guide brackets on the FRONT PANEL. You will need to make sure the walls are properly inserted into one another and that the LEFT SIDE PANEL is pulled all the way down and level with the FRONT PANEL at the top. The process for the RIGHT SIDE PANEL will be the same. Place the RIGHT SIDE PANEL next to the FRONT WALL PANEL. Lift the RIGHT SIDE PANEL up and onto the guide brackets on the FRONT PANEL. You will need to make sure the walls are properly inserted into one another and that the RIGHT SIDE PANEL is pulled all the way down and level with the FRONT PANEL at the top. (see Figure 9)



Figure 9

D. Installing the RIGHT SIDE REAR PANEL AND LEFT SIDE REAR PANEL

1. Determine which is the RIGHT SIDE REAR PANEL and which is the LEFT SIDE REAR PANEL (see V. Panel Descriptions Figure 7). The RIGHT SIDE REAR PANEL will have a cutout for the radio. Next, insert the LEFT SIDE REAR PANEL onto the FLOOR PANEL. The LEFT SIDE REAR PANEL will fit like a puzzle with the LEFT SIDE PANEL. Once they are inserted properly, you can buckle the two walls together. The RIGHT SIDE REAR PANEL will be a bit tight in installing. You will want to insert the bottom first onto the FLOOR PANEL and carefully work the top into place. Once the RIGHT SIDE REAR PANEL is properly inserted, you can buckle it to the RIGHT SIDE REAR PANEL and LEFT SIDE PANEL. (see Figure 10 and Figure 11)



Figure 10



Figure 11

E. Installing the ROOF PANEL

1. The side with the slight curve is the front of the ROOF PANEL. The power supply box faces upward on the ROOF PANEL.
2. The edge nearest the power supply is the front of the ROOF PANEL. Be careful of the wires

coming from the SIDE and REAR PANELS when you set the ROOF PANEL down onto the panels. Feed the wires through the holes in the ROOF PANEL. Feed the control cable and CD connectors down from the ROOF PANEL through the long-shaped hole to the inside of the sauna (for CD/radio hookup). (see Figure 12 and Figure 13)

3. Be careful not to force the ROOF PANEL into place. Make sure that the wires are properly fed through the holes.
4. When all the wires are fed through their appropriate holes, lower the ROOF PANEL into place.



Figure 12



Figure 13

F. Installing the BENCH EMITTER PANEL, BENCH PANEL and BENCHES

1. First, locate the FLOOR HEATER power cord. Connect the power cord into the wall outlet on the RIGHT SIDE REAR PANEL towards the back corner of the sauna room. Please note that you will only use 2 of the 4 outlet ports on the RIGHT SIDE REAR PANEL. (see Figure 14)
2. Locate the (2) square wood frames that have two cutouts (the cutouts will be installed facing the stationary glass panels) on one side and a vertical slot on the other side. Again, place one of the wood frames next to the glass window with the two cutouts facing the glass window and the vertical slot facing towards the front. The cutouts fit along the glass window moldings. The wood frames are **not** interchangeable and so make sure you have them next to the correct glass window. Do the same with the second wood frame next to the other glass window. (see Figure 15)
3. Slide down the BENCH EMITTER PANEL by lining up its sides with the vertical guides on the side panel and wood frame. The emitter grid will face outward (toward the front of the sauna) and the cord will be at the bottom of the emitter grid on the inside (between the BENCH EMITTER PANEL and the REAR PANEL). Push the BENCH EMITTER PANEL all the way down until it is touching the FLOOR PANEL and is secured in place. Do the same with the shorter bench panel. Be sure to plug the heater cords into the correct corresponding outlet on the applicable REAR WALL PANELS.
4. Plug in the left side BENCH EMITTER PANEL cord into the corresponding outlet located on the LEFT SIDE REAR PANEL. Do the same for the right side BENCH EMITTER PANEL. (see Figure 16 and Figure 17).
5. Install the longer of the two BENCHES first by tilting the end at the LEFT SIDE REAR PANEL and carefully guiding the other end downward and into position. Then slide the shorter of the two

BENCHES into its position. Push the BENCHES all the way in until they touch the REAR PANELS and are secured in place. Make sure to install the BENCHES with the smooth and finished sides facing up and the predrilled holes at the rear. It is optional if you would like to mount the benches using the provided screws. (see Figure 18 and Figure 19)

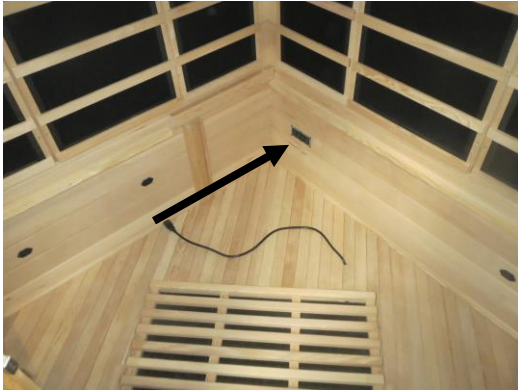

Figure 14

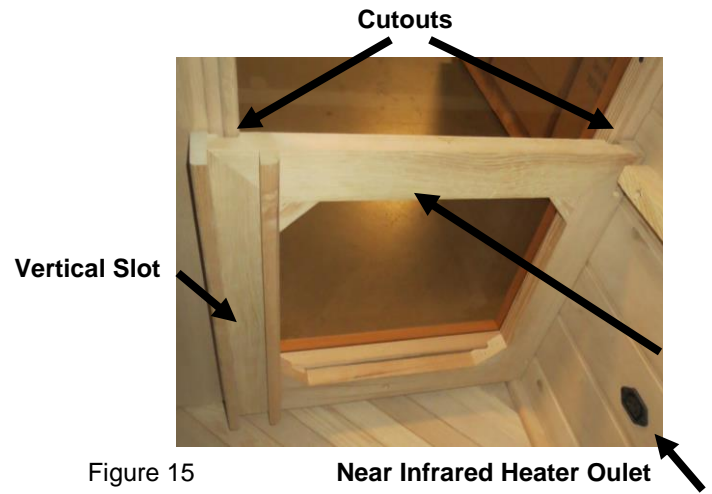

Figure 15

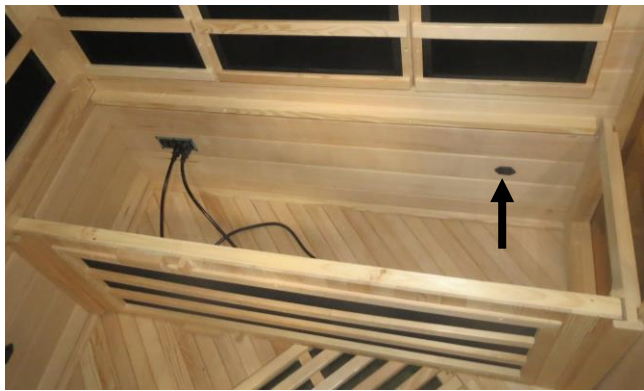

Figure 16



Figure 17

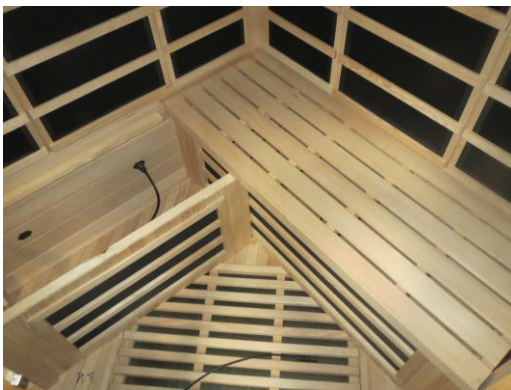

Figure 18

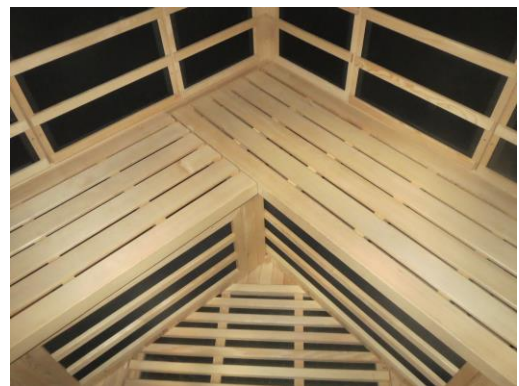

Figure 19

G. Installing the NEAR Infrared Heaters

1. First, you will need to locate the NEAR Infrared Heaters (if purchased as these are optional accessories). (see Figure 20)
2. From the inside of the sauna room, one adult will need to place the NEAR Infrared Heater up and onto the stationary glass panel lining up the mounting holes. A second adult will insert the knob and screw each knob one at a time to the NEAR Infrared Heater box from the outside of the sauna room. These knobs will only need to be hand tightened. Be sure not to over torque them. (see Figure 20a)
3. Next, connect the NEAR Infrared Heater cords to the single outlet on each of the REAR WALL PANELS. Please see the arrows in Figures 16, 17, and 20b.



Figure 20



Figure 20a

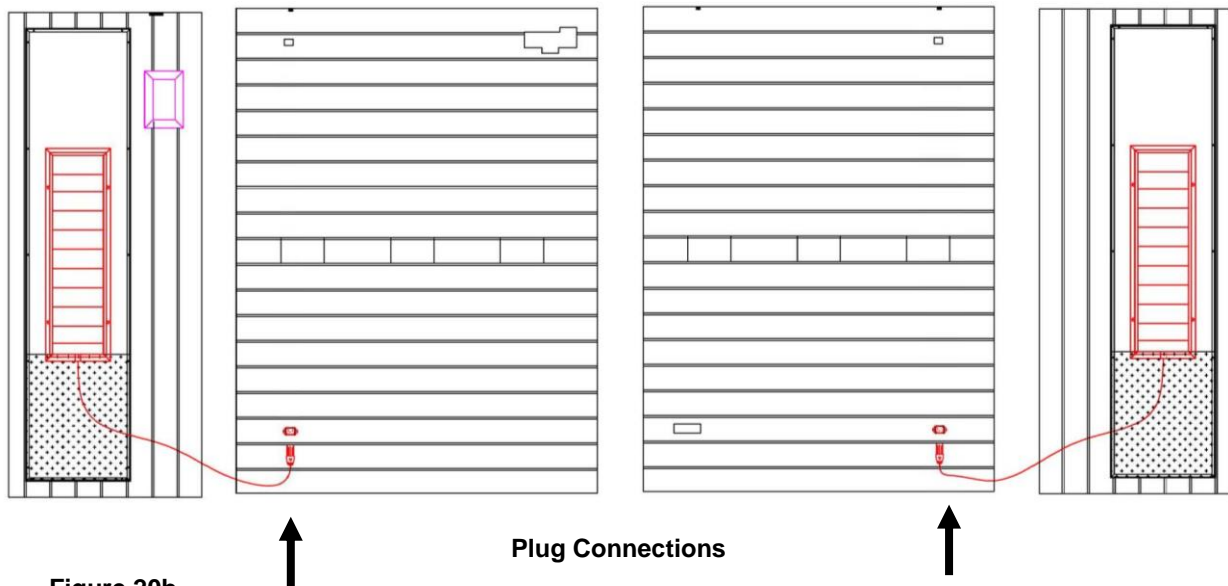

Figure 20b

Plug Connections

H. Connecting the plugs on the ROOF PANEL

1. Connect the plugs according to their respective labels. (see Figure 21 and Figure 22)
2. Connect the CTRL plug from the power supply box to the CTRL plug from the control panel. Then screw together. (see Figure 23)
3. Connect the buzzer connection. (see Figure 24)

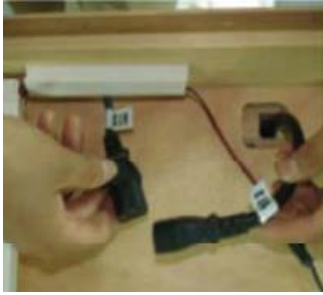

Figure 21

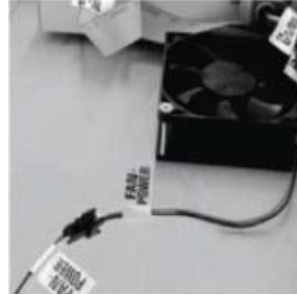

Figure 22

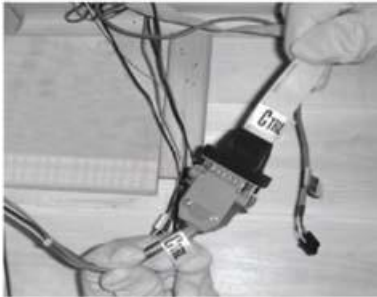

Figure 23

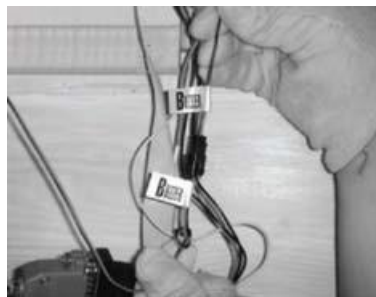

Figure 24

I. Assembling the RADIO BOX (optional)

1. Locate the wood sides for the CD/Radio housing. There is one for the front, side, and bottom. (see Figure 25)
2. Attach "A" on side panel with "A" on bottom panel and insert screws. (see Figure 26)
3. Attach "B" on front with "B" on side panel and "C" on front panel with "C" on bottom panel and insert screws. (see Figure 27)
4. Screw the RADIO BOX to the REAR PANELS. The back opening (the larger opening) on the RADIO BOX will face the RIGHT REAR PANEL. The front opening (the small opening and where the CD/radio is inserted) on the RADIO BOX will face the LEFT SIDE PANEL.

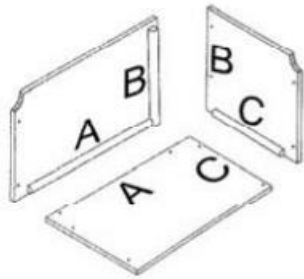

Figure 25

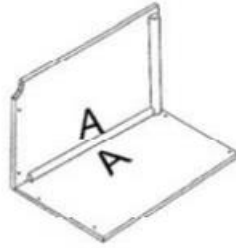

Figure 26

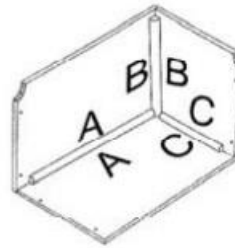

Figure 27

J. Installing the CD/RADIO (optional)

1. Unscrew the lock screws on the top of CD/RADIO player.
2. Connect the plug from the CD/RADIO with the plug coming down from the roof. (see Figure 28)
3. Connect the left and right speaker plugs. (see Figure 29 and 30)
4. Connect the antenna plug to the CD/RADIO player. (see Figure 31)
5. Insert the CD/RADIO into the RADIO BOX. It is not necessary to mount the CD/RADIO once you slide it into the RADIO BOX.



Figure 28



Figure 29

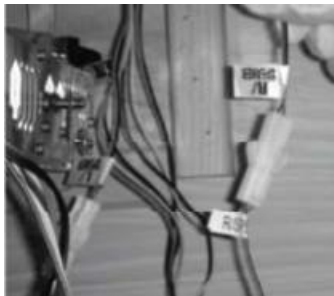

Figure 30



Figure 31

K. Installing the TEMPERATURE SENSOR

1. Enter the sauna and remove the protective covering (tape) from the TEMPERATURE SENSOR. Situate the TEMPERATURE SENSOR so that it is vertical and pointing downward. (see Figure 32)



Figure 32

Note: Some sauna models are shipped with a spare TEMPERATURE SENSOR in case the TEMPERATURE SENSOR is damaged during transit. The manufacturer decides this according to sauna models and packaging.

L. Putting on the ROOF COVER (optional)

1. Place the ROOF COVER over the top of the sauna. Be cautious when pulling the power cord through the hole in the roof cover. Slide the antenna through the slot allotted. Gently place the ROOF COVER onto the ROOF PANEL. When the edges are aligned, screw the ROOF COVER to the roof panel. (see Figure 33)



Figure 33

M. Optional Shelf

1. If your sauna comes with the optional MP3 shelf, use the provided screws and mount to the interior wall panel where there is no heat emitter panel. (see Figure 34)



Figure 34

Operating the Sauna

NOTE: Before the sauna is turned on, remove plastic protective covering from the CONTROL PANELS (if present). Please check and confirm that the connections to the POWER SUPPLY, HEAT EMITTERS, CD/RADIO, and TEMPERATURE SENSOR are connected properly. The power supply voltage and frequency must match the requested voltage and frequency of the sauna (120VAC 15AMP Dedicated Circuit or 120VAC 20AMP Dedicated Circuit).

Since many materials absorb the infrared rays, minimal clothing is recommended for maximum effect. The infrared sauna emitters are designed to heat you and not necessarily the air inside the sauna. It is not a hot box like a traditional sauna. The temperature gauge is a guide for your safety. It is recommended that you drink water before, during, and after sauna use to prevent dehydration since body fluids will be lost through perspiration. It is not recommended to shower after use since the pores in your skin will be open and could possibly absorb anything in the water.

1. Plug the sauna into the outlet receptacle.
2. Press the POWER button once. The POWER light will come on, the TIME DISPLAY will show 90 (minutes), the TEMPERATURE DISPLAY will show 66 (degrees Celsius), and the control panel will flash.
3. Press the up/down arrows under the TIME DISPLAY to adjust the amount of time you want the sauna to remain on. Press the C/F button to choose between Celsius and Fahrenheit. Press the up/down arrows under the TEMPERATURE DISPLAY to adjust the temperature setting. Once you have set these adjustments to the desired settings, press the START/WORK button. If you don't press the button for 5 seconds, the control panel will stop flashing and the set-up values will be memorized. The WORK and HEAT lights will now be on and the emitters will now be generating heat. You will need to pre-heat the sauna room to the set temperature before entering. Please keep in mind that you will increase the time it takes for the sauna room to reach the set temperature if you enter the sauna room before it has reached the set temperature.
4. During your sauna session, set-up time will count down the minutes one by one. When the time remaining is 5 minutes, the buzzer will make a warning sound for approximately 15 seconds letting you know you only have 5 minutes remaining. At this point, you can let the time run out or adjust the time by pressing the up/down arrows under the TIME DISPLAY. If you do choose to adjust the time, the control panel will flash and the emitters will stop generating heat. Once you set the time to the desired setting, then press the START/WORK button twice and the control panel will stop flashing and heat will begin coming from the emitters once again.
5. Heating times do vary. Generally, it will take approximately twenty to thirty minutes to preheat the sauna to 50 degrees Celsius / 122 degrees Fahrenheit. When the ambient temperature is low, heating requires additional time. For the first few times of use, you may use 46 degrees Celsius / 115 degrees Fahrenheit as a reference starting point for a time period of about 15 minutes (this represents the actual time you are in the sauna at the desired temperature). As you become more comfortable and familiar with the sauna, you can increase the temperature and time period according to personal preference.
6. When the temperature is at the set-up value, the digital control will maintain the set temperature. The WORK light will remain on and the HEAT light will turn off. The emitters will stop generating

heat. Once the inside temperature drops approximately 4 degrees, the HEAT light will turn back on and heat will again be generated by the emitters. With the digital control, the inside temperature will always remain around the set-up value.

7. Reading lamps and/or roof lamps and/or color therapy lamps are operated by pressing the respective buttons located towards the center of the control panel. These lamps are offered on some models and are not available on all models.
8. **Chromotherapy/Color Therapy Lighting (optional/not available on all models)** can be operated as follows. First, you will need to install the battery. Once the battery has been inserted into the remote, you are ready to operate the chromotherapy/color therapy lighting system. Press the READING LIGHT button on the sauna control panel. The white light will come on. While pointing the remote at the ceiling light, you can press any of the colors on the remote and that color will be displayed. You can use the SHADE button on the remote to go through a sequence of colors. If you want to turn the light off during your sauna session, you can press the POWER button on the remote. **Please note: You must be inside the sauna room for the remote to work.**

Chromotherapy/Color Therapy Lighting Remote



9. **Operating The FAR and NEAR Infrared Heaters** require only the pressing of a switch. The switch allows you to turn the FAR Infrared Carbon Heater Panel and Near Infrared Heater Panel either ON or OFF. Please note that you can only have either the FAR Infrared Carbon Heater Panel or the Near Infrared Heater Panel turned ON at any given time. The FAR Infrared Carbon Heater Panel which is affected is the one near the switch and on the rear wall panel closes to the side wall panel) You cannot have both the FAR Infrared Carbon Heater Panel and the NEAR Infrared Heater Panel turned ON at the same time. In position "I", both the FAR Infrared Carbon Heater Panel and the NEAR Infrared Heater Panels are turned OFF. In position "II", the NEAR Infrared Heater Panel will be turn ON. In position "III", the FAR Infrared Heater Panel will be turned ON. (see Figure 34.)



Figure 34

**Position "I" = OFF
(both heater types)**

**Position "II" = NEAR
Infrared Heater is ON**

**Position "III" = FAR
Infrared Carbon Heater is ON**

Sauna Control Panel

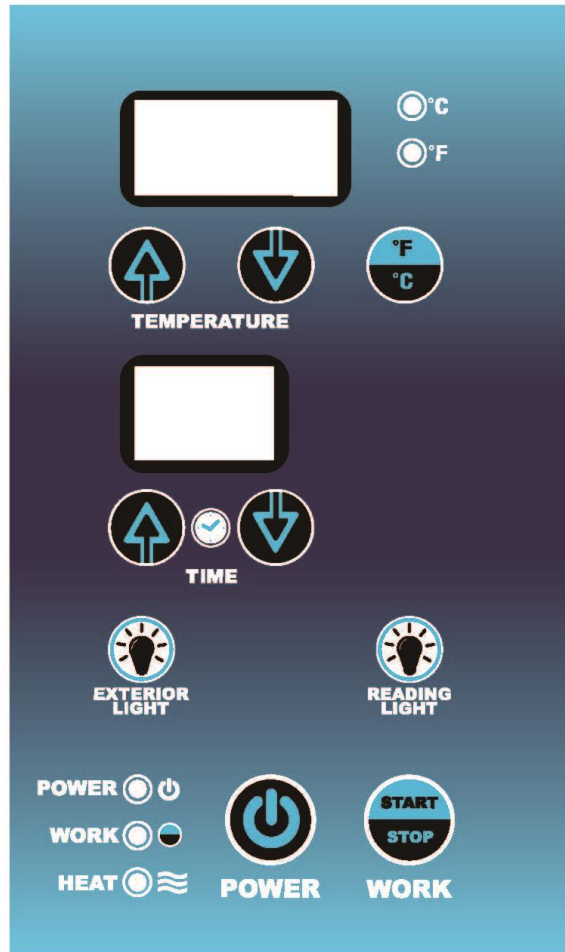

Control Panel Styles Vary By Model

Power On/Off: Press to control the main power of the sauna

Power Indicator: Indicates the status of the sauna's main power

Work Start/Stop: Press to control the working functions of the sauna

Work Indicator: Indicates the working status of the sauna

Heat Indicator: Indicates the status of heating function

Exterior Light/Reading Light: Press to control the lighting function

Time Display: Displays the heating time of the sauna in minutes

Time: Press to adjust the setting of the timer

Temperature Display: Displays the actual interior temperature of the sauna room in °C/°F

Temperature: Press to adjust the temperature setting

°C/°F: Press to change the temperature display between °C/°F

Tips for using Your Sauna

- 1) If you take a hot/warm shower or bath before using your sauna, you may perspire more and experience more comfort.
- 2) Drink water prior to, during, and after your sauna session to replenish body fluids.
- 3) To regulate the set temperature inside the sauna to your comfort level, use the movable roof ventilation or leave the door open slightly. The roof ventilation is installed on the sauna and used based on personal preference.
- 4) Use 2 or 3 towels during your sauna session. Fold one of the towels several times and place it on the bench. This towel will absorb some of your perspiration while adding comfort as you sit on the bench. Place another towel on the floor to absorb perspiration as it falls from your body (only on Ceramic Model Saunas). Be sure not to place any towels over the floor heat emitters. Use a third towel to wipe perspiration from your body from time to time.
- 5) At the first sign of a cold or flu, increasing your sauna sessions may be beneficial in boosting your immune system and decreasing the reproductive rate of viruses.
- 6) To help relieve sore and tense muscles, massage the affected areas during your sauna session.
- 7) To treat your ankles and feet more effectively, you can elevate them and move them close to one of the heat emitters to achieve a deep heating effect.
- 8) To utilize the sauna's heat therapy effect, put oil or treatment into your hair and wrap it with a towel. After your sauna session is over, rinse your hair thoroughly. Please follow the product directions for the intended benefits.
- 9) The peaceful and relaxed state rendered by a sauna session may help you to sleep easier and deeper.
- 10) To conserve energy consumption, please unplug your sauna when not in use.
- 11) After the sauna session is over, do not jump into the shower or bath immediately. Because your body was heated up during the sauna session, it will continue to perspire even after the heat emitters are off. Sit in the sauna with the door open slightly and let your body cool down. Once your body has cooled down and you feel comfortable, you can exit the sauna. After about twenty minutes and when your body has completely cooled down, you can take a shower to rinse the perspiration off your body.

Safety Instructions

- 1.) Read and follow all instructions carefully before using the sauna.
- 2.) When installing and using the electrical equipment, safety precautions should always be followed.
- 3.) To reduce the risk of injury, do not allow children to use the sauna unless they are closely supervised at all times by an adult.
- 4.) Do not use the sauna immediately following strenuous exercises. Wait at least 30 minutes to allow the body to cool down completely.
- 5.) Pregnant or possibly pregnant women should contact their physician prior to using the sauna. Excessive temperature has a high potential for causing fetal damage during pregnancy.
- 6.) **Hyperthermia Danger:** the normal body temperature can't rise above 39°C (103°F). Symptoms of excessive hyperthermia include dizziness, lethargy, drowsiness, and fainting. The effects of excessive hyperthermia may include failure to perceive heat, physical inability to exit sauna, unawareness of impending hazard, unconsciousness and fetal damage in pregnant women. Hyperthermia could make your body's core temperature rise. Setting desired temperature to an excessively high temperature is not recommended.
- 7.) The use of alcohol, drugs, or medications prior to or during the sauna session may lead to unconsciousness and/or other harmful physical injuries .

- 8.) Persons suffering from obesity or with a medical history of heart disease, low or high blood pressure, circulatory system problems, or diabetes should consult a physician prior to using the sauna.
- 9.) Persons using medications should consult a physician before using the sauna. Some medications may induce drowsiness while others may affect the heart rate, blood pressure, and/or blood circulation.
- 10) Exercise care before and after sauna use.
- 11) Never sleep inside the sauna.
- 12) Do not use any type of cleaning agents on the interior of the sauna. Only wipe down with a cloth and water.
- 13) Do not stack or store any object on top or inside the sauna.
- 14) If the power supply cord becomes damaged, it must be replaced immediately by the manufacturer or its agent . If you find the power cord is too hot or that the electrical equipment may be experiencing technical problems, please contact the manufacturer or its agent immediately to avoid hazardous conditions.
- 15) Do not use the sauna during an electrical storm to avoid risk of shock.
- 16) Do not continuously switch the power on and off as it will compromise the life of the electrical components.
- 17) Your hands must be dry and free of moisture before plugging and unplugging cords and wiring harnesses from the power supply and circuit boards. Never operate the sauna with wet hands or wet feet to avoid risk of electric shock. Never touch the metal prongs of the plug.
- 18) Do not attempt to make any repairs yourself. If a problem occurs with the sauna, please contact seller, distributor, or the manufacturer to avoid safety risks. Unauthorized repair attempts will void manufacturer's warranty.
- 19) Please make sure the outlet power supply meets the specifications required. Failure to meet the requirements may cause safety risks.
- 20) Some sauna models are equipped with reading and roof lamps. Because the lamp temperature will become very hot once powered on, do not attempt to touch the lamp to avoid being burned. Do not attempt to touch it for at least 20 minutes after it has been powered off.
- 21) Do not pour water or any other liquids on the infrared emitters. Do not bump, hit, or break the heating elements as it may cause an electrical short and pose a safety risk.
- 22) Do not make any modifications to the sauna, the sauna structure, or the sauna components.
- 23) Prior to each sauna session, the sauna room is to be inspected for correct operation. If for any reason your sauna room does not seem to be operating properly, discontinue use and contact the manufacturer.

Safeguards For Your Sauna

1. Do not install the sauna near water, near a bathtub, near a shower, in a wet basement, or near a swimming pool.
2. Do not use liquid cleaners or aerosol cleansers inside the sauna. Unplug the sauna from the wall outlet before cleaning. Use plain water and a soft cloth for cleaning.
3. The power supply cord should be routed so that it is not walked on or pinched by any object that may be placed against it.
4. When replacement parts are required, be sure they meet the specified requirements of the manufacturer. Unauthorized substitutes may result in fire, electric shock, or other hazardous conditions. After any repairs, please ask the service technician to perform safety checks to determine that your sauna is working properly.
5. Do not use any wall receptacle adapter or extension cord between the sauna cord and wall receptacle.

Troubleshooting Guide

1. No Heat Coming From Some Of The Heat Emitters

Solution: Check to make sure all the heat emitter cords are properly connected, including the cord to the heat emitter underneath the bench (if applicable). Go to the roof, and also check that the heat emitter cords are properly connected to the cords on the roof and that those cords are properly plugged into the power supply.

Solution: If some of the heat emitters are working, then the ones which are not working may have been damaged. Do not continue to operate. Contact the manufacturer for replacement parts.

Solution: If the heat emitters are not working but the control panel displays the time and temperature, then the temperature sensor may not be plugged in properly or it may be damaged. Turn the control panel off and then go to the roof of the sauna and locate the red and black wires near the air vent towards the rear of the sauna. After you have located the red and black wires labeled "TEMP SENSOR", disconnect them. Connect the spare temperature sensor. For testing purposes, insert the "TEMP SENSOR" (you just connected) down the vent on the roof so that it is now inside the sauna. Then go to the control panel and press the power button. If the heat emitters now have heat, then the "TEMP SENSOR" was the cause of the problem. You may have to wait about five minutes to confirm if the heat emitters are generating heat. Remove the original temperature sensor from its hole and replace it with the spare one.

2. Control Panel Malfunctioning

Solution: The control panel will turn on, but not off and the displayed numbers flash. The issue may be a connection problem. Go up to the roof and locate the "CTRL" wire harness you connected when the roof was installed onto the sauna room. Disconnect the "CTRL" wire harness, check the pins to make sure they are straight and not bent, and firmly reconnect the "CTRL" wire harness. Attempt to turn the sauna on at the control panel and check to see if the buttons are now responding. Contact the manufacturer for any additional troubleshooting.

Solution: The control panel will not turn off, the power/work/or heat lights do not come on, or the temperature and timer buttons do not work means the control panel may have been damaged and will need to be replaced. Contact the manufacturer for additional troubleshooting.

3. Sauna Shows Signs Of No Power

Solution: There could be one of a few problems causing this. First, check to see if the cord from the power supply is plugged into the wall outlet. Also check your main circuit breaker to confirm that it has not tripped. Check the power supply on the roof of the sauna to make sure there are no signs of malfunctioning, such as a high temperature, burning odor, or strange sounds. Also, check to make sure none of the power cords are damaged. If the power supply is malfunctioning or power cords are damaged, then unplug the sauna immediately and contact the manufacturer.

Solution: If your sauna is plugged in and you have no power at the control panel, then the power supply may need to be reset. Go to the roof of the sauna and locate the power supply. Press the RESET button to reset the power supply. The RESET button is on the same side of the power supply as all the heater cord connections. Attempt to turn the sauna on at the control panel. Contact the manufacturer for any additional troubleshooting.

Solution: There could be damage to the temperature sensor. If your sauna arrived with a spare

temperature sensor, turn the control panel off and go to the roof of the sauna and locate the red and black wire near the air vent towards the rear of the sauna. After you have located the red and black wires labeled "TEMP SENSOR", disconnect them. Connect the spare temperature sensor. For testing purposes, insert the "TEMP SENSOR" (you just connected) down the vent on the roof so that it is now inside the sauna. Then go to the control panel and press the power button. If the heat emitters now heat, then the temperature sensor was the cause of the problem. You may have to wait about five minutes to confirm if the heat emitters are generating heat. Remove the original temperature sensor from its hole and replace it with the spare one.

Solution: Check the wiring harnesses coming from the power supply located on the roof of the sauna. Make sure the wiring harness labeled "CTRL" is connected to the power supply at one end and connected to another wiring harness labeled "CTRL" at the other end. If this wiring harness is not properly connected, then the sauna will show signs of having no power.

4. **CD Player Will Not Work**

Solution: Check to make sure the lock screws on top of the radio have been removed. The CD player will not work if the screws are not removed.

Limited Lifetime Warranty

***Limited Lifetime Warranty:** Golden Designs, Inc. warrants the heating elements and electronics against defects in material and workmanship for the life of the product from the original date of purchase. **This sauna is for INDOOR use only. Placing your sauna outdoors will VOID this warranty. Any damage due to exposure to outdoor elements such as rain, snow, sun, wind or extreme temperatures will not be covered by this warranty. Any damages as a result of modifications made to the sauna or its components will void this warranty.**

Extent of Warranty

This limited warranty applies to products manufactured or distributed by Golden Designs, Inc. under the Dynamic brand name, delivered in the continental United States or Canada and extends to the original purchaser at the original site of installation only. This warranty becomes valid at time of purchase and terminates either by specified time frame listed above, owner transfer, or relocation. **Your sales receipt showing the date of purchase of the product is your proof of purchase.**

Manufacturer Warranty

All Golden Designs, Inc. products are manufactured with the highest quality appliances and are warranted to be free from defects in material and workmanship at the time of delivery. The appliance warranty is extended through the manufacturer for the product including, but not limited to: stereos, CD/DVD players, etc. All exchanged parts and products replaced under this warranty will become the property of Golden Designs, Inc. Golden Designs, Inc. reserves the right to change manufactures of any part to cover any existing warranty. Any parts determined to be defective must be returned to Golden Designs, Inc. to obtain warranty service. You must prepay any shipping charges, export taxes, custom duties and taxes, or any other charges associated with the transportation of the parts. In addition you are responsible for insuring any parts shipped or returned. You must present Golden Designs, Inc. with proof of purchase documents (including the date of purchase). Any evidence of alteration, erasing or forgery of proof of purchase documents will be cause to **VOID** this limited warranty. Products on which the serial number has been defaced or removed is not eligible for warranty service.

Warranty Limitations

This warranty does not apply if the unit has been subject to negligence, alteration, modification, misuse, abuse, repairs by non-Golden Designs, Inc. authorized personnel, inappropriate installations, or any case beyond the control of Golden Designs, Inc. invalidating this warranty including but are not limited to:

- Use of lacquer or paints
- Sauna and other Golden Designs, Inc. products accessories placed on non-approved surfaces
- Outdoor applications
- Normal wear and tear or weathering
- Use of product not in accordance with instructions

Surface cracks are not considered defects in material or workmanship, as they are normal characteristics of all woods. This includes minor cracks due to wood expansion and contraction. Note: Since the wood used in construction has been kiln dried, a certain amount of expansion and contraction occurs in the wood in a sauna environment.

Disclaimers

Golden Designs, Inc. shall not be liable for loss of use of sauna or other Golden Designs, Inc. products or other secondary or incidental or consequential costs, expense or damages - which may include the removal of permanent deck or other custom fixtures or the necessity for crane removal - arising directly or indirectly out of the use or inability to use the product. Any implied warranty shall have duration equal of the applicable warranty stated above. Under no circumstances shall Golden Designs, Inc. or any of its representatives be held liable for injury to any person or damage to any property, however arising. Specifications are subject to change without notice or obligation.

Legal Remedies

This limited warranty gives you specific legal rights. You may have other rights, which may vary from state to state.

Customer Service

For customer service, contact your authorized dealer. If you need additional information or assistance, please email Golden Designs, Inc. At info@goldendesignsinc.com or call (909) 212-5555.

*Limited Lifetime Warranty of Sauna Products is 7 years on heating elements and electronics from the date of purchase. The wood structure has a 3 year limited warranty and the radio has a 1 year limited warranty.

PAGE INTENTIONALLY LEFT BLANK

WARRANTY CARD

Congratulations on your purchase of an Infrared Sauna from Golden Designs, Inc. Please take the time to complete the following Warranty Card and mail it back to:

**Golden Designs, Inc.
3550 Jurupa Street, Unit B
Ontario, CA 91761**

Please include a copy of your sales receipt showing date of purchase as this will serve as proof of purchase.

Warranty will be VOID if the following warranty card is not mailed back within 60 days of purchase date along with proof of purchase.

****Serial number (S/N) is located on the sauna's front panel, rear panel, or on the carton.****

DETACH HERE



WARRANTY CARD

All fields must be completed to validate the warranty.

Name: _____

Address: _____

City: _____ State: _____ Zip Code: _____

Phone Number: _____

Purchase Date: _____

Purchase From: _____

Serial Number: _____