

8MP Deep Learning IR Dome Network Camera

IPC3638SB-ADZK-IO



Key Features



Ultra
H.265

WDR

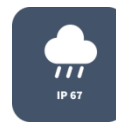

Smart

- Perimeter Protection, include Cross Line, Intrusion, Enter Area, Leave Area detection
- Based on target classification, smart intrusion prevention significantly reduce false alarm caused by leaves, birds and lights etc., accurately focus on human and vehicle.

Optics

- Day/night functionality
- Smart IR, up to 40m (131ft) IR distance
- Up to 120 dB WDR (Wide Dynamic Range)
- 2D/3D DNR (Digital Noise Reduction)

Compression

- Ultra 265, H.265, H.264, MJPEG
- ROI (Region of Interest)
- Customized OSD

Network

- ONVIF Conformance

Structure

- Wide temperature range: -30°C ~ 60°C (-22°F ~ 140°F)
- Wide voltage range of ±25%
- IP67
- IK10 vandal resistant
- 3-Axis

Specifications

IPC3638SB-ADZK-I0					
Camera					
Sensor	1/2.8", 8.0 megapixel, progressive scan, CMOS				
Lens	2.8 ~ 12mm, AF automatic focusing and motorized zoom lens				
DORI Distance	Lens (mm)	Detect (m)	Observe (m)	Recognize (m)	Identify (m)
	2.8	86.9	34.8	17.4	8.7
	12	372.4	149.0	74.5	37.2
Angle of view (H)	107.4° ~ 29.2°				
Angle of View (V)	54.2° ~ 16.3°				
Angle of View (O)	111.0° ~ 33.1°				
Adjustment angle	Pan: 0° ~ 360°		Tilt: 0° ~ 75°		Rotate: 0° ~ 360°
Shutter	Auto/Manual, 1 ~ 1/100000s				
Minimum Illumination	Colour: 0.003Lux (F1.6, AGC ON) 0Lux with IR				
Day/Night	IR-cut filter with auto switch (ICR)				
Digital noise reduction	2D/3D DNR				
S/N	>56dB				
IR Range	Up to 40m (131ft) IR range				
Wavelength	850nm				
IR On/Off Control	Auto/Manual				
Defog	Digital Defog				
WDR	120dB				
Video					
Video Compression	Ultra 265,H.265, H.264, MJPEG				
H.264 code profile	Baseline profile, Main Profile				
Frame Rate	Main Stream: 8MP (3840*2160), Max 20fps;5MP (3072*1728), Max 30fps; 4MP (2560*1440), Max30fps; 1080P (1920*1080), Max 30fps; Sub Stream: 1080P (1920*1080), Max 30fps;720P (1280*720), Max 30fps; D1 (720*576), Max 30fps; 640*360,Max 30fps; 2CIF(704*288), Max 30fps; CIF(352*288), Max 30fps; Third Stream: D1 (720*576), Max 30fps; 640*360,Max 30fps; 2CIF(704*288), Max 30fps; CIF(352*288), Max 30fps;				

Video Bit Rate	128 Kbps~16 Mbps
OSD	Up to 8 OSDs
Privacy Mask	Up to 4 areas
ROI	Up to 8 areas
Motion Detection	Up to 4 areas
Image	
White Balance	Auto/Outdoor/Fine Tune/Sodium Lamp/Locked/Auto2
Digital noise reduction	2D/3D DNR
Smart IR	Support
Flip	Normal/Vertical/Horizontal/180°/90°Clockwise/90°Anti-clockwise
Dewarping	Supported
HLC	Supported
BLC	Supported
Audio	
Audio Compression	G.711
Suppression	Supported
Sampling Rate	8KHZ
Storage	
Edge Storage	Micro SD, up to 256GB
Network Storage	ANR
Smart	
Smart intrusion Prevention (Deep Learning Algorithm)	Cross Line, Intrusion, Enter Area, Leave Area detection;
Behavior Detection	Motion detection, Tampering alarm, Audio Detection
Network	
Protocols	IPv4, IGMP, ICMP, ARP, TCP, UDP, DHCP, RTP, RTSP, RTCP, DNS, DDNS, NTP, FTP, UPnP, HTTP, HTTPS, SMTP, SSL
Compatible Integration	ONVIF (Profile S, Profile G, Profile T), API
Client	EZStation EZView EZLive
Web Browser	Plug-in required live view: IE9+, Chrome 41 and below, Firefox 52 and below
	Plug-in free live view: Chrome 57.0+, Firefox 58.0+, Edge 16+, Safari 11+
Interface	
Built-in Mic	Supported
Network	1 RJ45 10M/100M Base-TX Ethernet
Certifications	
Certifications	CE: EN 60950-1 UL: UL60950-1 FCC: FCC Part 15
General	
Power	DC 12V±25%, PoE (IEEE 802.3af)
	Power consumption: Max 9.0W
Dimensions (Ø x H)	Φ129 x 110mm (Ø5.1" x 4.3")
Net Weight	0.69kg (1.52lb)

Material	Metal
Working Environment	-30°C ~ 60°C (-22°F ~ 140°F), Humidity: ≤95% RH (non-condensing)
Storage Environment	-30°C ~ 60°C (-22°F ~ 140°F), Humidity: ≤95% RH (non-condensing)
Surge Protection	6KV
Ingress Protection	IP67
vandal resistant	IK10
Reset Button	Supported

Dimensions

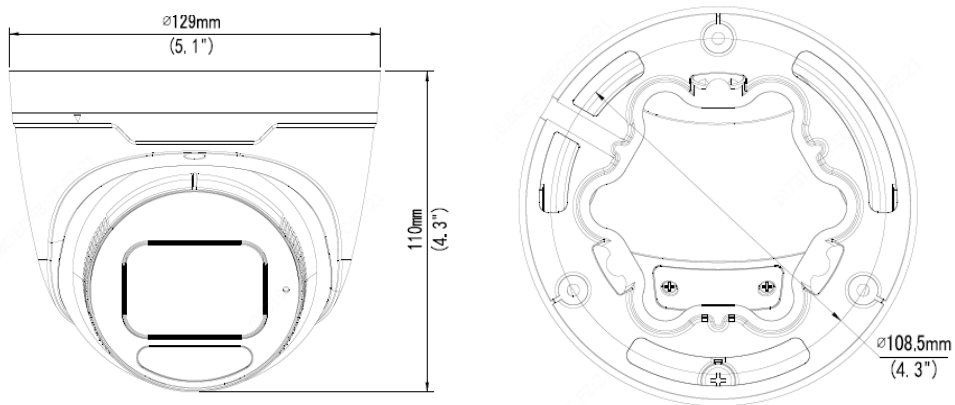

Accessories

TR-JB03-H-IN



TR-JB07/WM03-F-IN

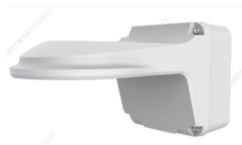

TR-WM03-B-IN

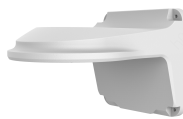

TR-UP06-IN



TR-A01-IN



TR-SE24-IN



TR-SE24-A-IN



TR-CM24-IN



Junction Mount	Pole Mount
TR-JB03-H-IN	TR-JB07/WM03-F-IN(TR-WM03-B-IN)+TR-UP06-IN

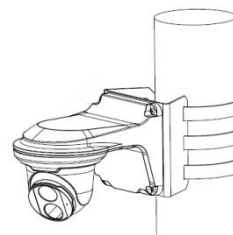
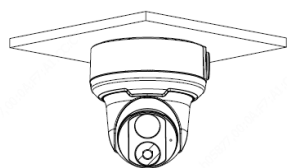

TR-CM24-IN+TR-JB03-H-IN

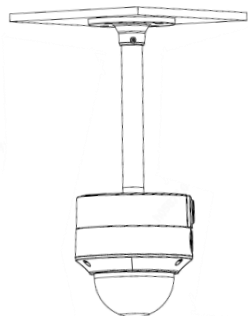

Zhejiang Uniview Technologies Co., Ltd.

Building No.10, Wanlun Science Park, Jiangling Road 88, Binjiang District, Hangzhou, Zhejiang, China (310051)

Email: overseasbusiness@uniview.com; globalsupport@uniview.com

<http://www.uniview.com>

©2020 Zhejiang Uniview Technologies Co., Ltd. All rights reserved.

*Product specifications and availability are subject to change without notice.