

# Akuvox X912

## Quick Guide

### Unpacking

Before you begin using the device, please check the version you got and ensure that the following items are included in the shipped box:

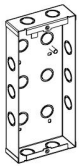

**Flush-mounting box x1**

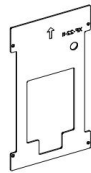

**Flush-mounting plate x1**

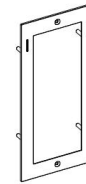

**Flush-mounting bracket x1**

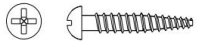

**ST4X20 crosshead screw x4**



**Plastic wall anchor x4**



**M3X8 crosshead screw x4**



**M4x16 torx head screw x2**



**Torx wrench x1**

# Akuvox X912

## Product Overview

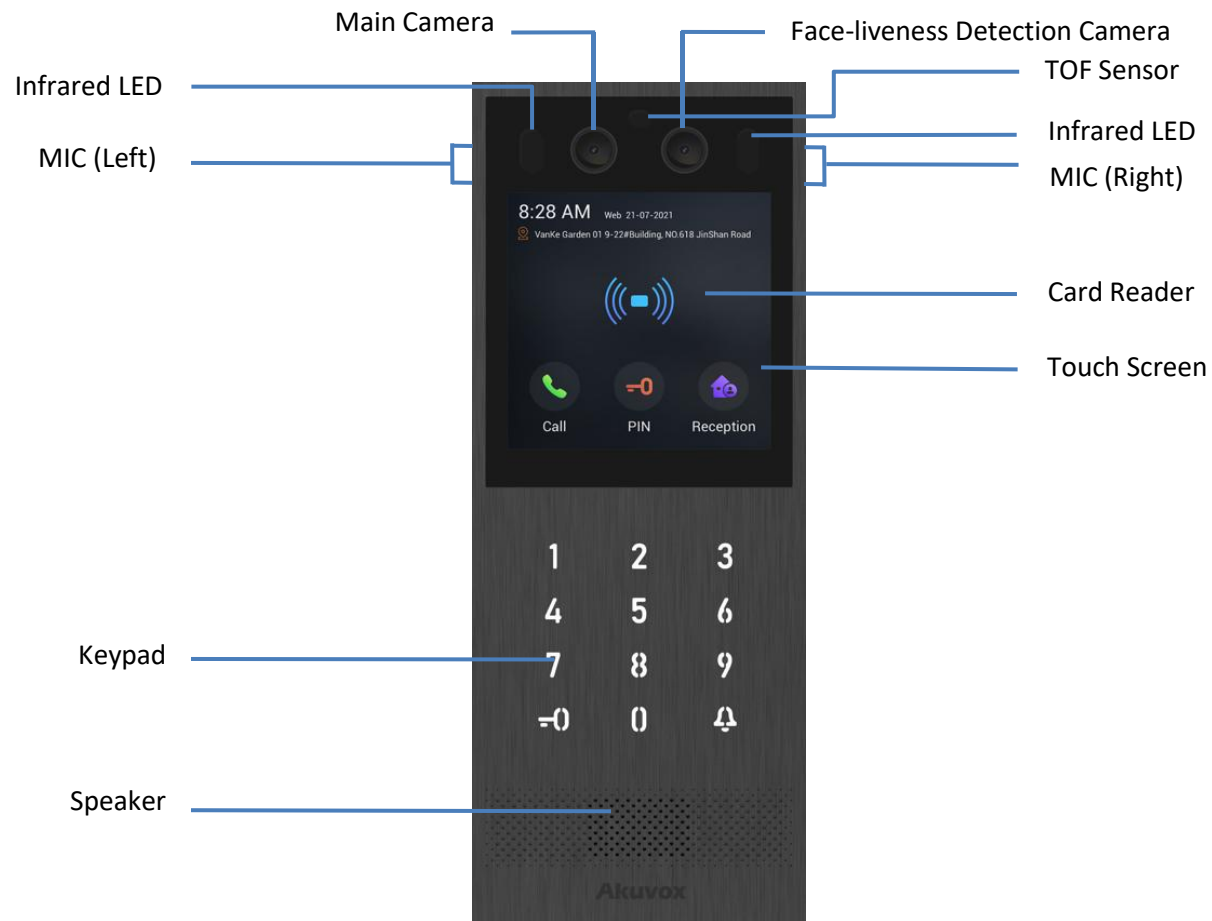

# Akuvox X912

## Installation Environment

Please do not place device under direct sunlight.  
If installing the device indoors, please keep device at least 2 meters away from light, and at least 3 meters away from window and door.

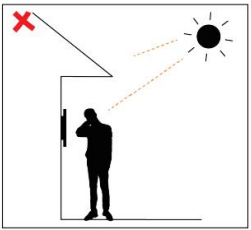

Backlight

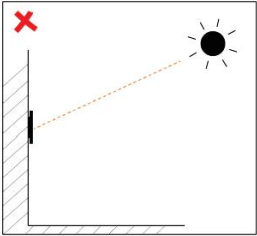

Direct sunlight

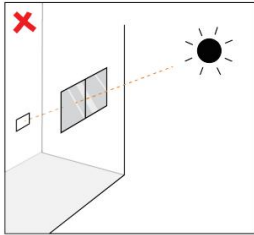

Direct sun  
through window

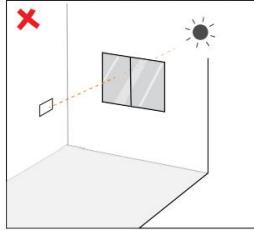

Indirect sunlight  
through window

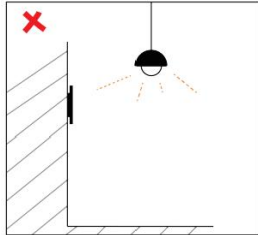

Close to light

### Attention:

Biometric recognition product may not be considered 100% accurate in any identification application.  
For higher security purpose or scenario, please set up access authentication along with biometric recognition.

# Akuvox X912

## Installation

### Step1: Flush-mounting Box Installation

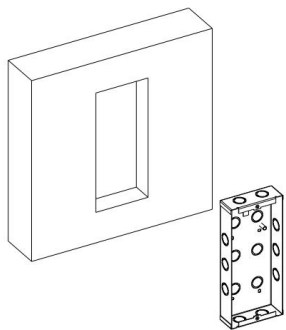

According to the position of the cable, cut a square hole in the wall. (height\*width\*depth=265\*116\*45mm)

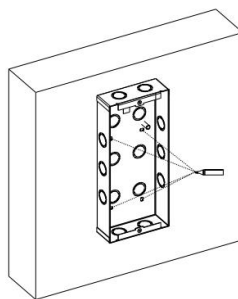

Place flush-mounting box in the square hole, then mark the four holes of flush-mounting box on the wall, and make sure the mark should be in the center of hole.

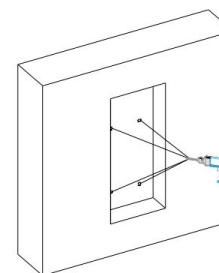

Take down the flush-mounting box then use a hand drill to make four holes with diameter of 6mm and depth of 25mm at the marked positions.



The top surface line up with wall

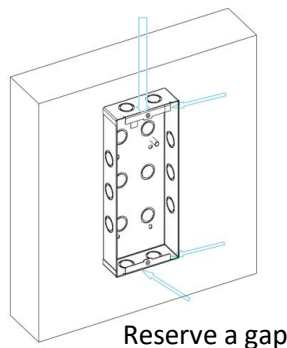

As the figure shows, please make sure that the top surface of flush-mounting box should be lined up with the wall. And please reserve a gap between the bottom of flush-mounting box and wall

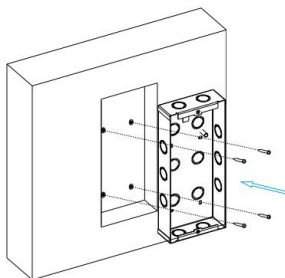

Knock off the cable holes, and through all cables out of the holes. Then push flush-mounting box into the square hole, and use four ST4x20 crosshead screws to fix flush-mounting box on the wall.

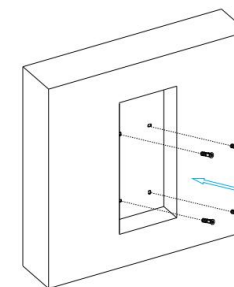

Insert the four plastic wall anchors into the holes.



# Akuvox X912

## Step2: Wiring Cover Installation

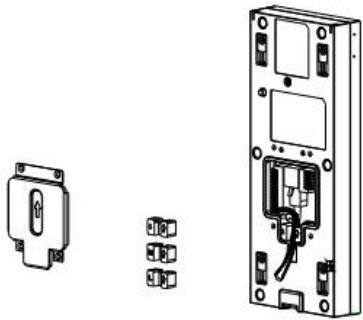

Take out the device, wiring cover, and rubber plug.

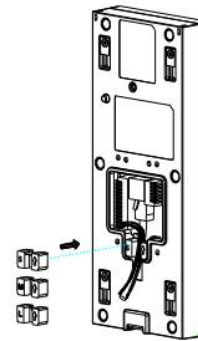

Choose a suitable size rubber plug (small, large and medium) to hold down the wires, while tearing off the adhesive sticker on the selected rubber plugs and plug them into the back cover in the position as indicated in the drawing. Connect the network cables to the corresponding interface of the mainboard, then connect the signal wire to the corresponding connection holes.

Note: All the cables and wires must go through the opening at the rubber plug position.

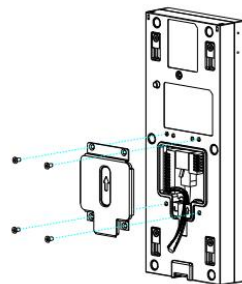

Use four M3x4 crosshead screws to fix wiring cover on the back cover.



# Akuvox X912

## Step3: Device Installation

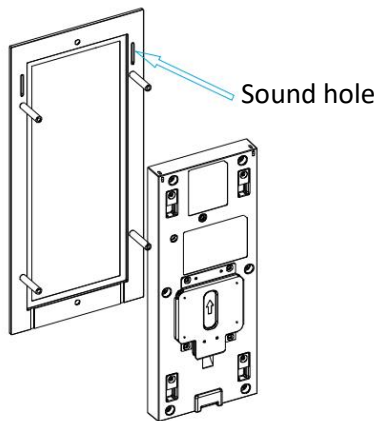

Combine the device with the flush-mounting bracket according to the direction indicated in the figure.

Note: The sound hole of flush-mounting bracket should be upper, and sound hole and arrow of wiring cover should be in the same direction.

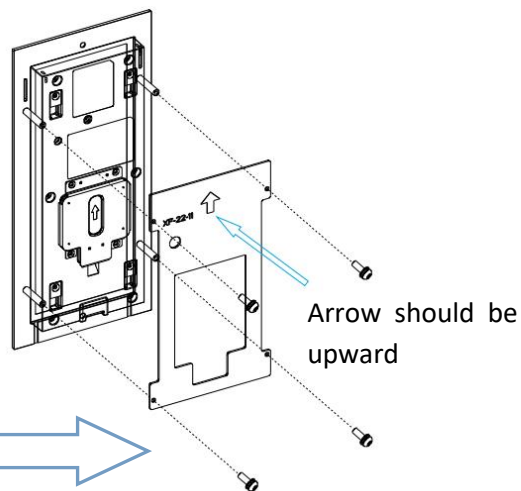

Align the fixing hole of flush-mounting plate with the bolts of flush-mounting bracket, then insert flush-mounting plate onto the flush-mounting bracket. Use four M3x8 crosshead screws to fix flush-mounting plate.

Note: The direction of plate's arrow should be upward and the same as wiring cover's arrow.

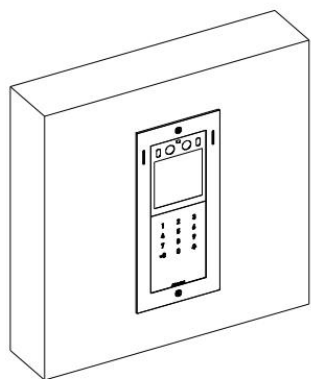

Check if the gap surrounding the device is even and securely installed. Make sure to reserve a gap and power on the device to check the device is normal. Installation is completed.

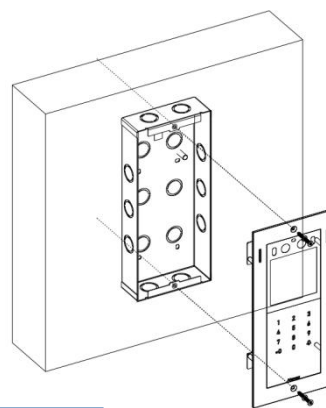

Align the fixing holes of flush-mounting bracket with the fixing holes of flush-mounting box, and use torx wrench to tighten flush-mounting plate with two M4x16 torx head screws.



# Akuvox X912

## Device Wiring

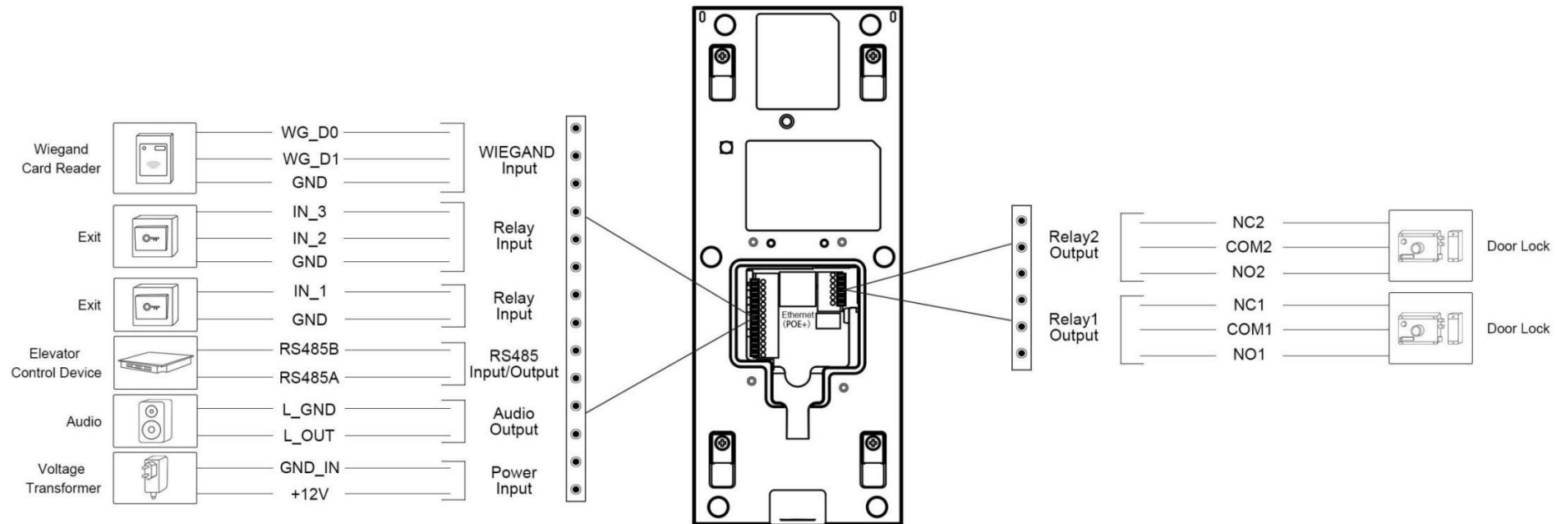

### ⚠ Warning

When you connect a device containing a coil, such as a relay or an electromagnetic lock, it is necessary to protect the intercom against voltage peak while switching off the induction load. For this way of protection we recommend a diode 1 A / 200 V (included in the accessories) connected antiparallel to the device.

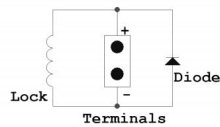

# Akuvox X912

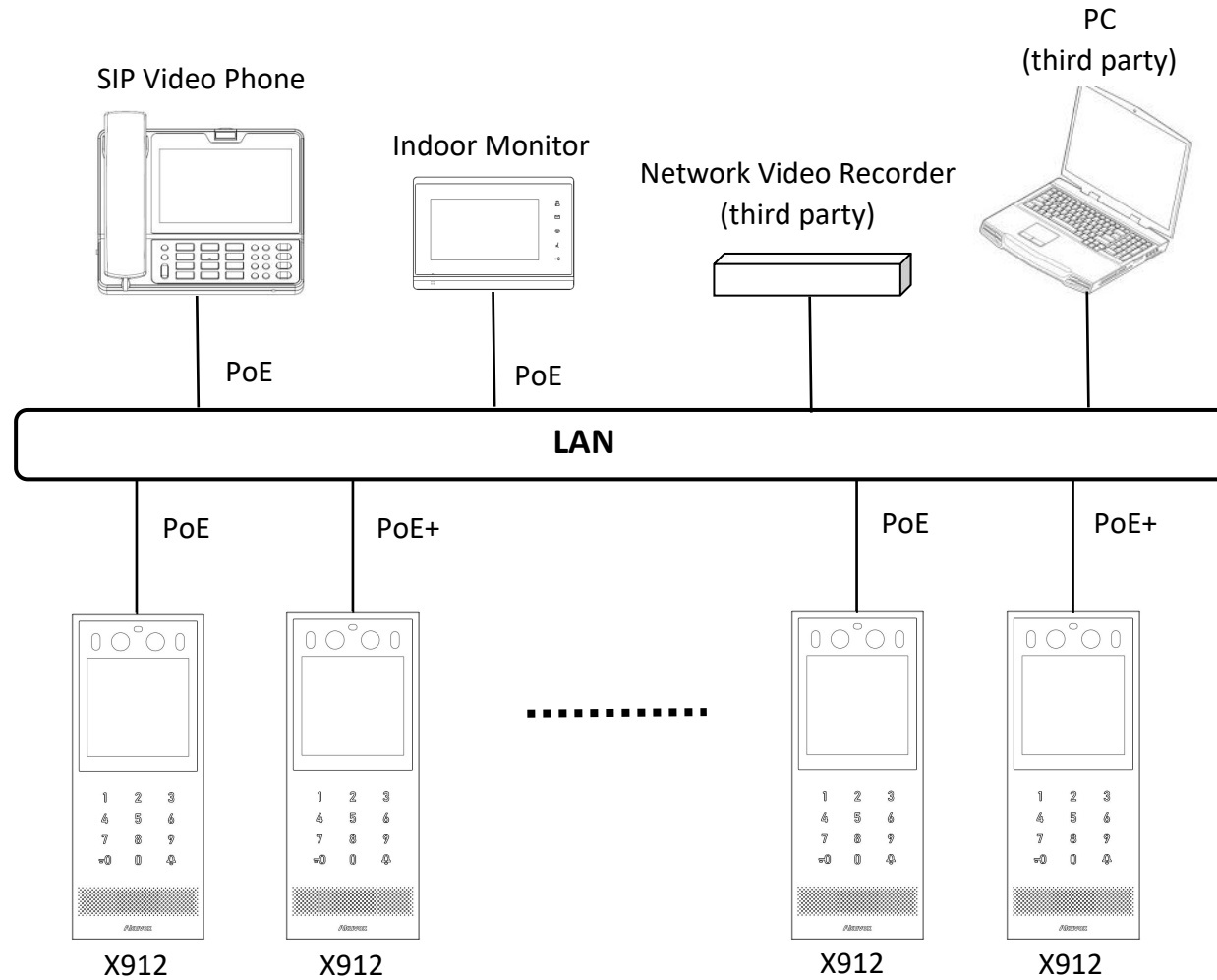

## Application Network Topology





# Akuvox X912

## Configuration

1. **IP Address Checking:** Press **Key Icon**  on the home interface or on the dial pad, then press 2396 and **Bell Icon**  to enter the system interface, and press **System Information** to check the device IP address. X912 uses DHCP by default.
2. **Account Registration:** On the web interface, go to the path **Account > Basic** page to register and fill in the account information. **(Please refer to user manual for more information)**

## Operation

### Make a call:

Enter the IP or SIP number and press **Bell Icon**  to make a call.

### Receive a call:

X912 supports Auto Answer by default. Incoming call from indoor device will be answered automatically.

### Unlock by PIN:

Press **Key Icon**  on the home interface or on the dial pad, then enter the PIN code, and press the Key Icon on the dial pad for the confirmation.

### Unlock by RF Card:

Place the configured RF card on the card reader area for door access.

# Akuvox X912

## *Note Information*

*Information contained in this document is believed to be accurate and reliable at the time of printing. This document is subject to change without notice, any update to this document can be viewed on Akuvox's website: <http://www.akuvox.com> © Copyright 2022 Akuvox Ltd. All rights reserved.*

