



















Unpacking

Before you start using the device, please check the product version, and ensure that the following items are included in the shipped box:



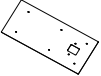
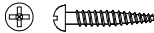

Mainframe Accessories :

- | | | | |
|--|---|--|--|
|  S539 x 1 |  Rubber plug (small) x 2 |  Rubber plug (medium) x 2 |  Wiring cover x 1 |
|  Rubber plug (large) x 2 |  Sealing ring x 1 |  M3x4 crosshead screw x 6 |  Diode x 3 |
|  Torx wrench x 1 |  2x5-PIN terminal block x 1 |  2-PIN terminal block x 1 |  Rope x 1 |
|  2x6-PIN terminal block x 1 |  Pry tool (for terminal block) x 1 | | |
|  M3x7.5 torx head screw x 1 | | | |

Wall-mounting Accessories (Please find in On-Wall Installation Kit box):

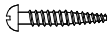
- | | | |
|--|--|---|
|  Wall-mounting box x 1 |  Wall-mounting template x 1 |  ST4 x 20 crosshead screw x 6 |
|  M4 x 30 crosshead screw x 2 |  Plastic wall anchor x 6 | |

Flush-mounting Accessories (Please find in In-Wall Installation Kit box):

- | | | |
|---|--|--|
|  Flush-mounting box x 1 |  ST4 x 20 crosshead screw x 6 |  Plastic wall anchor x 6 |
|  Flush-mounting bracket x 1 |  M4 x 8 crosshead screw x 6 | |

Product Overview



Installation Environment

Please do not place device under direct sunlight.
If installing the device indoors, please keep device at least 2 meters away from light, and at least 3 meters away from window and door.

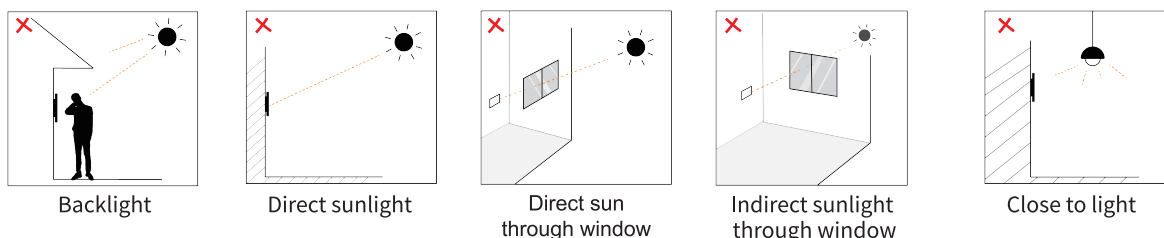

Attention:
Biometric recognition product may not be considered 100% accurate in any identification application.
For higher security purpose or scenario, please set up access authentication along with biometric recognition.

Installation

Step 1: Wall-mounting Box or Flush-mounting Box Installation

1. Wall-Mounting

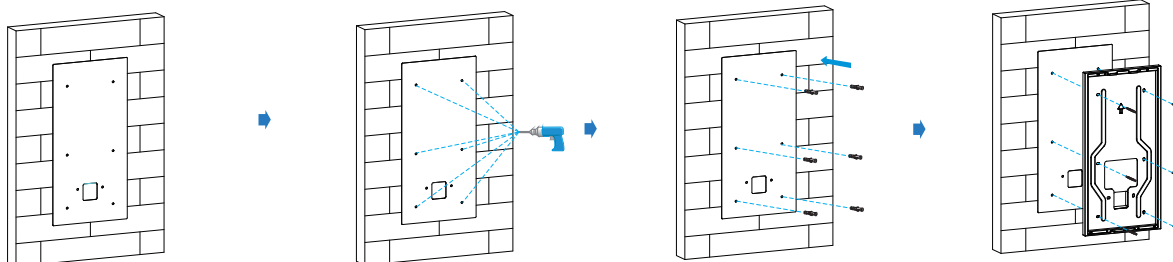

Stick wall-mounting template onto the wall according to your need, and please make sure all cables can go through the wiring hole on the template.

Note: If there is 86-embedded box installed in the wall, please align template's screw holes with the box's.

Use an electric drill with a 6mm diameter bit to make six holes with 25mm depth according to the hole of wall-mounting template.

Insert six plastic wall anchors into the holes.

Use six ST4x20 crosshead screws to fix the wall-mounting box on the wall. Or use four ST4x20 crosshead screws and two M4x30 crosshead screws to fix the wall-mounting box on the 86-embedded box.

2. Flush-Mounting

2.1. Flush-mounting box installation with screws

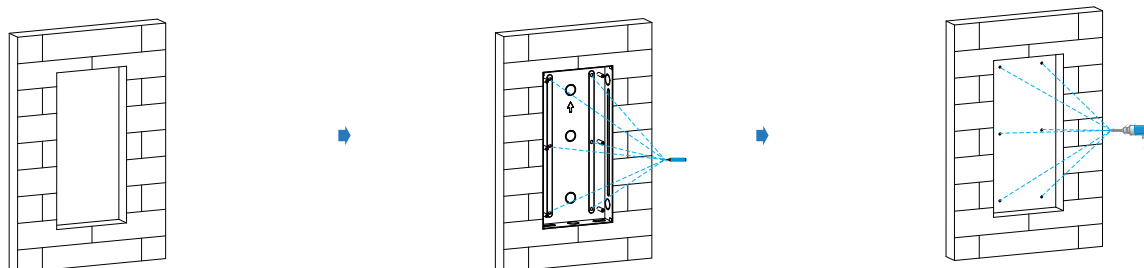

Dig out a square hole (height*width*depth=353.5*169*41mm) that can accommodate all cables. And please lead cables through the hole, or reserve the PVC conduit.

Note: The hole can be larger than recommended size based on the actual situation.

Knock off a cable hole of flush-mounting box according to your need. Place the box on the hole, and lead cables through the hole. Then mark six holes of the box on the wall.

Take out the flush-mounting box on the hole, then use an electric drill with a 6mm diameter bit to make six holes with 25mm depth.

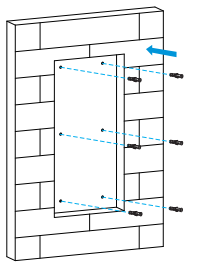

Insert six plastic wall anchors into the holes.

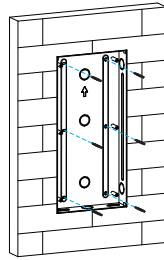

Place the flush-mounting box on the hole, and lead cables through the hole. Then use six ST4x20 crosshead screws to fix the box on the wall.

Note: The edge of the flush-mounting box should be aligned with wall, and the inclination angle of the box should be less than 2°.

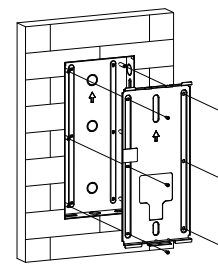

Use six M4x8 crosshead screws to fix the flush-mounting bracket on the flush-mounting box.

2.2. Flush-mounting box installation without screw (the vandal resistance is lower than using screw)

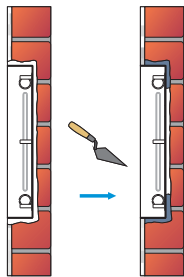

Use cement or non-corrosive structural adhesives to fill the gap between the wall and the flush-mounting box. And decorate the surface of gap with material the same as the wall. Wait for the material dry, then go to the next step.

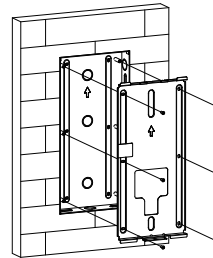

Use six M4x8 crosshead screws to fix the flush-mounting bracket on the flush-mounting box.

Step 2: Wiring Cover Installation

Wall-mounting or Flush-mounting

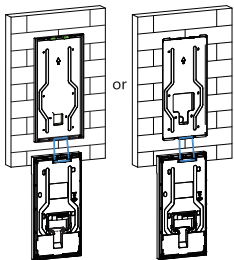

Hang the device onto the square hanger on the wall-mounting/flush-mounting box for the convenience of the wiring.

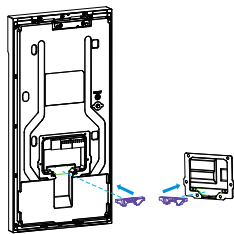

Choose suitable size rubber plugs (small, large and medium), then insert one into the back cover of device, and insert another one into the corresponding groove of the wiring cover.

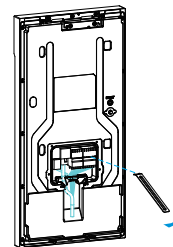

Connect the wires to the terminal blocks as needed (for details, refer to "Device Wiring"), then insert the terminal blocks into the corresponding interface of the main board as indicated in the drawing.

Note: The pry tool can be used to unplug the terminal block if needed.

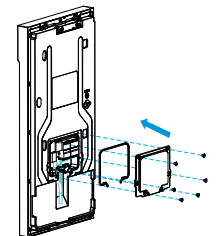

Press sealing ring and wiring cover into the corresponding groove as indicated by the arrow, then tighten the wiring cover by six M3x4 crosshead screws.

Step 3: Device Mounting

Wall-mounting

Flush-mounting

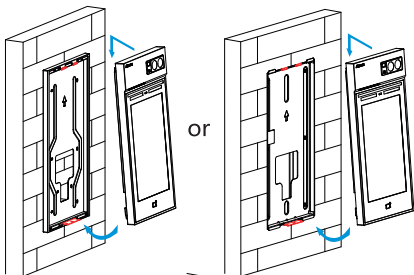

Take off the rope and hang the device onto the square hangers on the wall-mounting box/flush-mounting box at an angle as shown in the picture. Then move the bottom of device close to box.

Note: The protrusion of the box should be covered by the device.

Wall-mounting or Flush-mounting

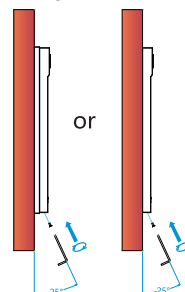

Use torx wrench to screw M3x7.5 torx head screw into the screw hole on the bottom of device diagonally upward as shown in the picture.

Wall-mounting

Flush-mounting

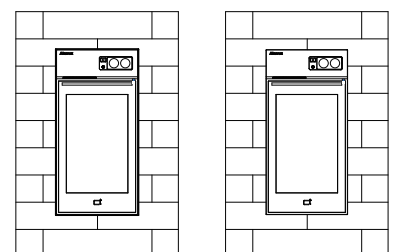

Installation is completed, please remove the protective film.

Device Wiring

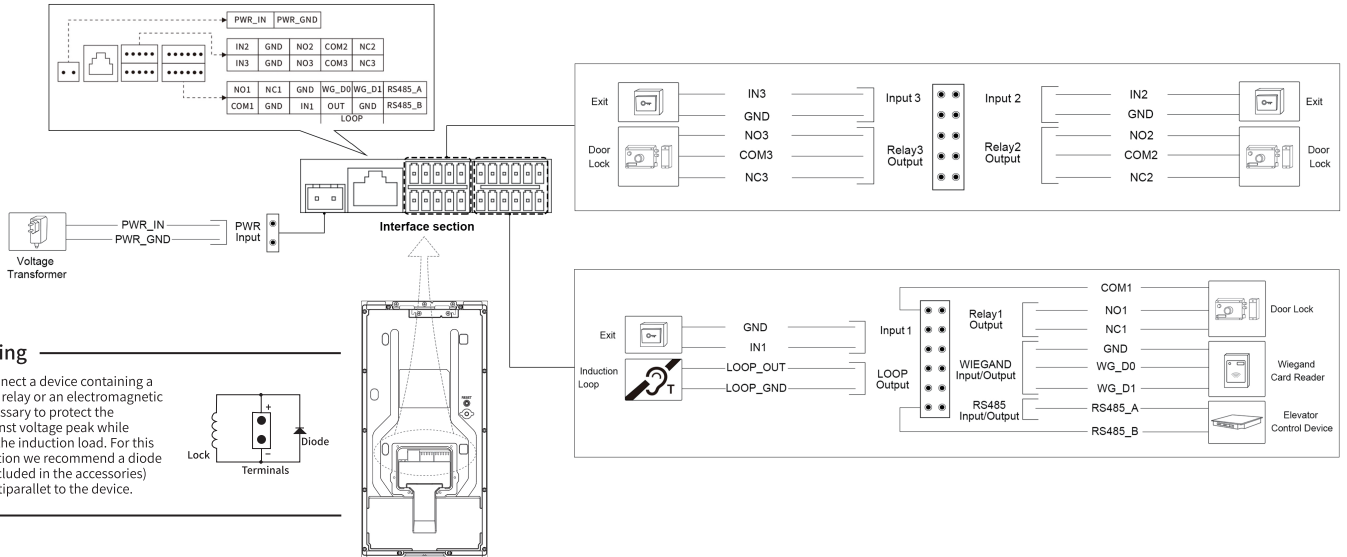

Wire Length & AWG Table

Please follow the properly measured wire gauge/length to install device:

	12 AWG	14 AWG	16 AWG	18AWG	20 AWG
12V 4A Adapter	≤35m	≤25m	≤15m	≤10m	\
24V 2A Adapter	≤40m	≤30m	≤20m	≤10m	≤5m

Application Network Topology

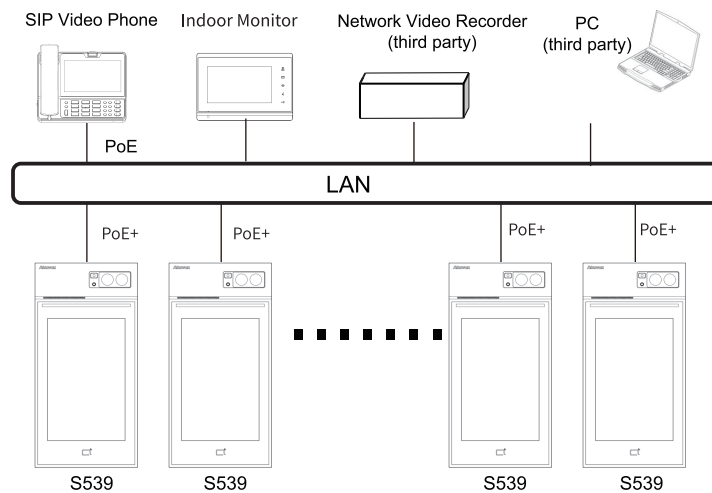

Face Enrollment Standards

1. Quality standard

Distorted facial photo is beautified, overexposed, too-dark, blurred, or disproportional image, and can not be identified because it makes facial features less identifiable. As well as face is covered by a hat, mask or other and the photo is not taken from a live face, which can cause face can not be identified. And it suggested that you take photos indoors to avoid distorted pictures.

2. Recommended face angle

The face enrolled should be in front view. Raise or lower your head in less than 30 degrees, turns your head left or right in less than 25 degrees, and tilt your head left or right in less than 30 degrees.



3. Distance recommendation

Use an image with a face that is within the distance from camera. The distance should be more than 40 cm and less than 1 m. There should be at least 10% proportion marginal space around the face.



4. Image format requirement

Use an image in .jpg/png/bmp format. The face image cannot be rotated.

5. Size specification

Ensure that images are sufficiently large in terms of resolution, device can recognize images larger than 250x250 pixels.

6. Example of an acceptable face image

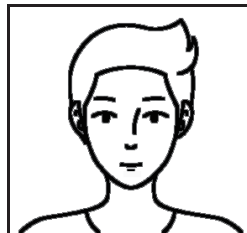

Tips for Facial Recognition

Follow the following facial recognition requirement.

- Upward or downward face in less than 20 degrees.
- Turn your face (left or right) in less than 25 degrees.
- Tilt your face in less than 30 degrees.
- Show full face without any coverings.

Configuration

1.IP Address Checking: Press 9999 on the dial screen, then press 3888 to enter the system screen and click **Info** to check the device IP address. S539 uses DHCP by default.

2.Account Registration: On the device, go to **Setting > Account** to enable the function and fill in the account information, then click **Submit**. (Please refer to user manual for more information).

Operation

Make a call:

Click Call icon, then enter the IP or SIP number to make a call.

Receive a call:

S539 supports Auto Answer by default. Incoming call from indoor device will be answered automatically.

Unlock by PIN:

Click **PIN icon** to enter PIN code for the door access.

Unlock by RF Card:

Place the configured RF card on the card reader area for the door access.



Notice Information

Information contained in this document is believed to be accurate and reliable at the time of printing. This document is subject to change without notice, any update to this document can be viewed on Akuvox's website: <http://www.akuvox.com> © Copyright 2022 Akuvox Ltd. All rights reserved.

AKUVOX (XIAMEN) NETWORKS CO., LTD.

Add.: 10/F, NO.56 GUANRI ROAD, SOFTWARE PARK II, XIAMEN 361009, CHINA
www.akuvox.com

